

FERMAX

PLACA CITYLINE 4+N
4+N CITYLINE OUTDOOR PANEL
CITYLINE PLATINE 4+N
4+N CITYLINE TÜRSTATION
PLACA CITYLINE 4+N

MANUAL DE INSTALADOR
INSTALLER'S MANUAL
MANUEL D'INSTALLATION
INSTALLATIONSHANDBUCH
MANUAL DO INSTALADOR

MANUAL DE INSTALADOR INSTALLER'S MANUAL MANUEL D'INSTALLATION
INSTALLATIONSHANDBUCH MANUAL DO INSTALADOR MANUAL DE INSTAL
ADADOR MANUAL DE INSTALADOR INSTALLER'S MANUA
LATION INSTALLATIONSHANDBUCH MANUAL DO INSTALA
STALADOR INSTALLER'S MANUAL MANUEL D'INSTALLATION
SHANDBUCH MANUAL DO INSTALADOR MANUAL DE INSTAL
MANUAL MANUEL D'INSTALLATION INSTALLATIONSHANDBUC
H INSTALLADOR MANUAL DE INSTALADOR INSTALLER'S MANUA
LATION INSTALLATIONSHANDBUCH MANUAL DO INSTALA
STALADOR INSTALLER'S MANUAL MANUEL D'INSTALLATION

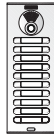

ESPAÑOL
ENGLISH
FRANÇAIS
DEUTSCH
PORTUGUÊS

FERMAX

PLACA CITYLINE 4+N
4+N CITYLINE OUTDOOR PANEL
CITYLINE PLATINE 4+N
4+N CITYLINE TÜRSTATION
PLACA CITYLINE 4+N

MANUAL DE INSTALADOR
INSTALLER'S MANUAL
MANUEL D'INSTALLATION
INSTALLATIONSHANDBUCH
MANUAL DO INSTALADOR

MANUAL DE INSTALADOR INSTALLER'S MANUAL MANUEL D'INSTALLATION
INSTALLATIONSHANDBUCH MANUAL DO INSTALADOR MANUAL DE INSTAL
ADADOR MANUAL DE INSTALADOR INSTALLER'S MANUA
LATION INSTALLATIONSHANDBUCH MANUAL DO INSTALA
STALADOR INSTALLER'S MANUAL MANUEL D'INSTALLATION
SHANDBUCH MANUAL DO INSTALADOR MANUAL DE INSTAL
MANUAL MANUEL D'INSTALLATION INSTALLATIONSHANDBUC
H INSTALLADOR MANUAL DE INSTALADOR INSTALLER'S MANUA
LATION INSTALLATIONSHANDBUCH MANUAL DO INSTALA
STALADOR INSTALLER'S MANUAL MANUEL D'INSTALLATION

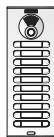

ESPAÑOL
ENGLISH
FRANÇAIS
DEUTSCH
PORTUGUÊS

E ENHORABUENA POR DISPONER DE UN PRODUCTO DE CALIDAD!

Fermax electrónica desarrolla y fabrica equipos de prestigio que cumplen los más altos estándares de diseño y tecnología. Esperamos disfrute de sus funcionalidades.

EN CONGRATULATIONS ON PURCHASING THIS QUALITY PRODUCT!

Fermax Electronics develops and manufactures reputable equipment which fulfils the highest design and technology standards. We hope you enjoy its range of functions.

F FÉLICITATIONS ! VOUS VENEZ D'ACQUÉRIR UN VÉRITABLE PRODUIT DE QUALITÉ!

Fermax Electrónica développe et fabrique des équipements de prestige qui répondent aux normes de design et technologie les plus développées. Nous espérons que vous profiterez pleinement de toutes ses fonctions.

D WIR GRATULIEREN IHNEN ZUM KAUF DIESES QUALITÄTSPRODUKTS!

Fermax Electrónica entwickelt und fabriziert hochwertige Anlagen, die den höchsten Technologie- und Designstandards entsprechen. Überzeugende Funktionalität für Ihr Eigenheim!

P PARABÉNS POR DISPOR DE UM PRODUTO DE QUALIDADE!

Fermax electrónica desenvolve e fabrica equipamentos de prestígio que cumprem com os mais altos padrões de desenho e tecnologia. Esperamos que desfrute das suas funcionalidades.

Cod. 97448d V11_10

Pag 2

E ENHORABUENA POR DISPONER DE UN PRODUCTO DE CALIDAD!

Fermax electrónica desarrolla y fabrica equipos de prestigio que cumplen los más altos estándares de diseño y tecnología. Esperamos disfrute de sus funcionalidades.

EN CONGRATULATIONS ON PURCHASING THIS QUALITY PRODUCT!

Fermax Electronics develops and manufactures reputable equipment which fulfils the highest design and technology standards. We hope you enjoy its range of functions.

F FÉLICITATIONS ! VOUS VENEZ D'ACQUÉRIR UN VÉRITABLE PRODUIT DE QUALITÉ!

Fermax Electrónica développe et fabrique des équipements de prestige qui répondent aux normes de design et technologie les plus développées. Nous espérons que vous profiterez pleinement de toutes ses fonctions.

D WIR GRATULIEREN IHNEN ZUM KAUF DIESES QUALITÄTSPRODUKTS!

Fermax Electrónica entwickelt und fabriziert hochwertige Anlagen, die den höchsten Technologie- und Designstandards entsprechen. Überzeugende Funktionalität für Ihr Eigenheim!

P PARABÉNS POR DISPOR DE UM PRODUTO DE QUALIDADE!

Fermax electrónica desenvolve e fabrica equipamentos de prestígio que cumprem com os mais altos padrões de desenho e tecnologia. Esperamos que desfrute das suas funcionalidades.

Cod. 97448d V11_10

Pag 2

INDICE - INDEX - SOMMAIRE - INHALT - INDICE

E AMPLIFIADOR 4+N	4
Instalación del amplificador	4
Conectores / Ajustes / Reset a valores de fábrica	6
Precableado / Cableado	10
Características Técnicas	24
EN 4+N AMPLIFIER	4
Amplifier installation	4
Connectors / adjustment / Reset a valores de fábrica	6
Internal wiring / Wiring	10
Technical Features	24
F AMPLIFICATEUR 4+N	4
Installation du amplificateur	4
Connecteurs / Réglages / Reset a valores de fábrica	6
Précâblage / Câblage	10
Caractéristiques techniques	24
D 4+N-VERSTÄRKER	4
Installation des Netzgeräts	4
Anschlüsse / Einstellungen / Nullstellung auf werksseitige Parameter	6
Vorverkabelung / Verkabelung	10
Technische Eigenschaften	24
P AMPLIFICADOR 4+N	4
Instalação do amplificador	4
Conectores / Ajustes / Reset para valores de fábrica	6
Pré-cablagem / Cablagem	10
Características Técnicas	24

INDICE - INDEX - SOMMAIRE - INHALT - INDICE

E AMPLIFIADOR 4+N	4
Instalación del amplificador	4
Conectores / Ajustes / Reset a valores de fábrica	6
Precableado / Cableado	10
Características Técnicas	24
EN 4+N AMPLIFIER	4
Amplifier installation	4
Connectors / adjustment / Reset a valores de fábrica	6
Internal wiring / Wiring	10
Technical Features	24
F AMPLIFICATEUR 4+N	4
Installation du amplificateur	4
Connecteurs / Réglages / Reset a valores de fábrica	6
Précâblage / Câblage	10
Caractéristiques techniques	24
D 4+N-VERSTÄRKER	4
Installation des Netzgeräts	4
Anschlüsse / Einstellungen / Nullstellung auf werksseitige Parameter	6
Vorverkabelung / Verkabelung	10
Technische Eigenschaften	24
P AMPLIFICADOR 4+N	4
Instalação do amplificador	4
Conectores / Ajustes / Reset para valores de fábrica	6
Pré-cablagem / Cablagem	10
Características Técnicas	24

4+n Panels

FERMAX

- E** AMPLIFICADOR 4+N
- F** AMPLIFICATEUR 4+N
- P** AMPLIFICADOR 4+N

- EN** 4+N AMPLIFIER
- DN** 4+N VERSTÄRKER

AUDIO

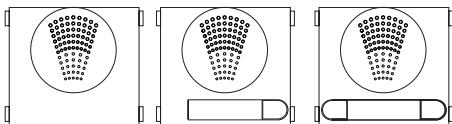

VIDEO

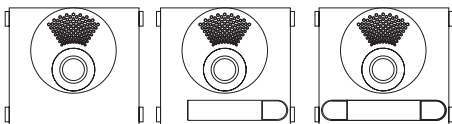

4+n Panels

FERMAX

- E** AMPLIFICADOR 4+N
- F** AMPLIFICATEUR 4+N
- P** AMPLIFICADOR 4+N

- EN** 4+N AMPLIFIER
- DN** 4+N VERSTÄRKER

AUDIO



VIDEO

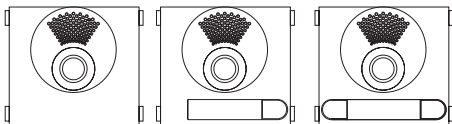

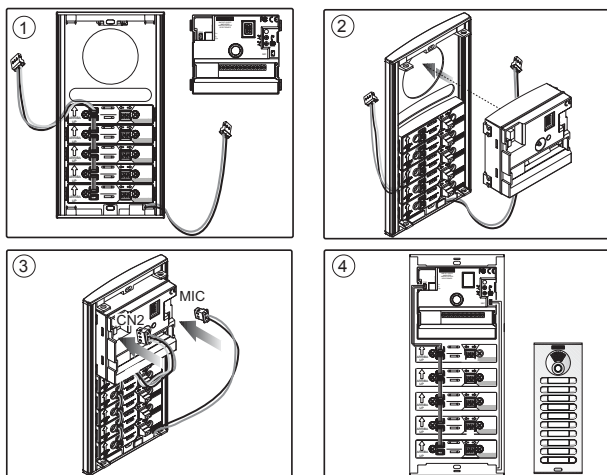

- ① INSTALACIÓN AMPLIFICADOR Y PULSADORES
- ② AMPLIFIER AND BUTTON INSTALLATION
- ③ INSTALLATION AMPLIFICATEUR ET BOUTONS-POUSSOIRS
- ④ INSTALLATION VERSTÄRKER UND TASTEN
- ⑤ INSTALAÇÃO DO AMPLIFICADOR E BOTÕES

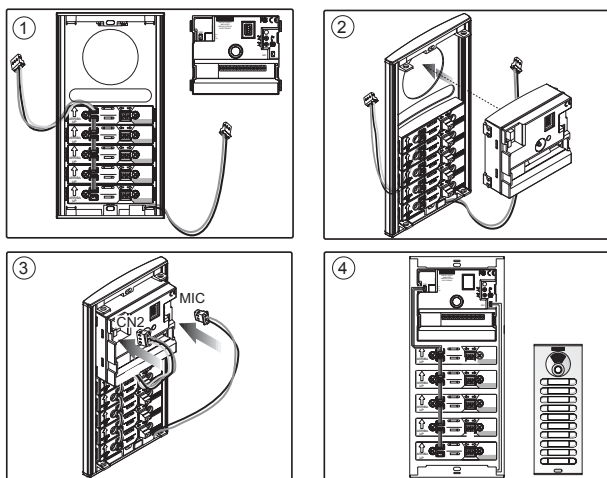

- ① INSTALACIÓN AMPLIFICADOR Y PULSADORES
- ② AMPLIFIER AND BUTTON INSTALLATION
- ③ INSTALLATION AMPLIFICATEUR ET BOUTONS-POUSSOIRS
- ④ INSTALLATION VERSTÄRKER UND TASTEN
- ⑤ INSTALAÇÃO DO AMPLIFICADOR E BOTÕES



JP4	1 	 N
E Placas instaladas	1 Placa	varias placas (con cambiadores automáticos)
EN Panels installed	1 Panel	various panels (with automatic switchers)
F Platinés installées	1 Platine	plusieurs platines (avec commutateurs automatiques)
D Installierte Türstation	1 Türstation	mehrere Türstationen (mit automatischen Umwandlern)
P Placas instaladas	1 Placa	várias placas (com conversores automáticos)

(*) Configuración por defecto: 1 Placa - Default Configuration: 1 Panel - Configuration par défaut: 1 Platine - Standardkonfiguration: 1 Türstation
Configuração por defeito: 1 Placa

CN1
E Conexión para placas digitales
EN Connection for digital panels
F Connexion pour platines numériques
D Anschluss für digitale Türstationen
P Ligaçao para placas digitais



D) CN2	L+ / L-	CP
E Conexión iluminación tarjeteros y pulsadores	Luz tarjetero pulsador	Común de pulsadores
EN Connection card holder and button lighting	Cardholder Backlight	Common Button Wire
F Connexion éclairage boutons-poussoirs et porte-étiquettes	Lumière porte-étiquettes bouton-poussoir	Connecteur commun de boutons-poussoirs
D Anschluss Tasten- und Infomodul-Beleuchtung	Beleuchtung Taste Infomodul	Gemeinsamer Draht der Klingeltasten
P Ligaçao de iluminação dos porta-cartões e botões	Luz do porta-cartões do botão	Comum de botões

E)	
	<ul style="list-style-type: none"> E Selección del idioma del mensaje de «puerta abierta». EN Select language for «open door» message. F Sélection de la langue du message « porte ouverte ». D Sprachwahl der Meldung «Tür offen». P Seleção da língua da mensagem de «porta aberta».

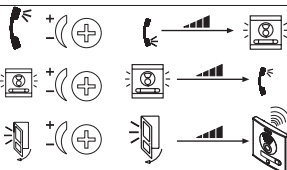
Ver CODIFICACIÓN al final de este manual. See CODIFICATION at the end of this manual. Voir CODIFICATION à la fin de ce manuel. Siehe KODIERUNG am Ende dieses Handbuchs. Ver CODIFICAÇÃO no final deste manual.

F)	
<ul style="list-style-type: none"> E Ajuste audio EN Adjust the audio F Réglez le volume D Audioeinstellung P Ajuste o áudio 	 <ul style="list-style-type: none"> E "puerta abierta" EN "open door" F « porte ouverte » D "Tür offen" P "porta aberta"

Pag 7

JP4	1 	 N
E Placas instaladas	1 Placa	varias placas (con cambiadores automáticos)
EN Panels installed	1 Panel	various panels (with automatic switchers)
F Platinés installées	1 Platine	plusieurs platines (avec commutateurs automatiques)
D Installierte Türstation	1 Türstation	mehrere Türstationen (mit automatischen Umwandlern)
P Placas instaladas	1 Placa	várias placas (com conversores automáticos)

(*) Configuración por defecto: 1 Placa - Default Configuration: 1 Panel - Configuration par défaut: 1 Platine - Standardkonfiguration: 1 Türstation
Configuração por defeito: 1 Placa

CN1
E Conexión para placas digitales
EN Connection for digital panels
F Connexion pour platines numériques
D Anschluss für digitale Türstationen
P Ligaçao para placas digitais

D) CN2	L+ / L-	CP
E Conexión iluminación tarjeteros y pulsadores	Luz tarjetero pulsador	Común de pulsadores
EN Connection card holder and button lighting	Cardholder Backlight	Common Button Wire
F Connexion éclairage boutons-poussoirs et porte-étiquettes	Lumière porte-étiquettes bouton-poussoir	Connecteur commun de boutons-poussoirs
D Anschluss Tasten- und Infomodul-Beleuchtung	Beleuchtung Taste Infomodul	Gemeinsamer Draht der Klingeltasten
P Ligaçao de iluminação dos porta-cartões e botões	Luz do porta-cartões do botão	Comum de botões

E)	
	<ul style="list-style-type: none"> E Selección del idioma del mensaje de «puerta abierta». EN Select language for «open door» message. F Sélection de la langue du message « porte ouverte ». D Sprachwahl der Meldung «Tür offen». P Seleção da língua da mensagem de «porta aberta».

Ver CODIFICACIÓN al final de este manual. See CODIFICATION at the end of this manual. Voir CODIFICATION à la fin de ce manuel. Siehe KODIERUNG am Ende dieses Handbuchs. Ver CODIFICAÇÃO no final deste manual.

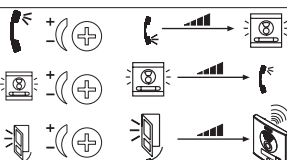
F)	
<ul style="list-style-type: none"> E Ajuste audio EN Adjust the audio F Réglez le volume D Audioeinstellung P Ajuste o áudio 	 <ul style="list-style-type: none"> E "puerta abierta" EN "open door" F « porte ouverte » D "Tür offen" P "porta aberta"

Pag 7

G)

- E** Enfoque la telecámara
- EN** Focus the camera
- F** Réglez la caméra vidéo
- D** Richten Sie die Kamera aus
- P** Foque a telecámara.

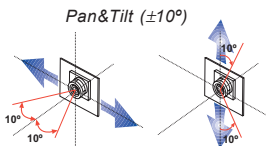

H)

E Conectores Placa:

- Bomas de video, (coaxial).
V: vivo
M: malla
Ct: activación telecamara (10 Vdc)
- Bomas de Conexión del sistema:
 \sim, \sim : alimentación (12 Vac/Vdc).
+18, -: alimentación (18 Vdc).
1, 2, 3, 6: comunes audio
Cp1: común de pulsadores doble tono
Cp2: común de pulsadores simple tono
C, No: conexión abrepuertas.
- : conexión Pulsador.

EN Panel Connectors:

- Video terminals (coaxial):
V: live
M: shield
Ct: camera activation (10 Vdc)
- System connection terminals:
 \sim, \sim : power supply (12 Vac/Vdc).
+18, -: power supply (18 Vdc).
1, 2, 3, 6: commons for audio
Cp1: double tone button common wire
Cp2: single tone button common wire
C, No: door-opener connection
- : Button Connection.

F Connecteurs platine:

- Bomes vidéo (câble coaxial).
V: vif
M: maille
Ct: activation caméra (10 Vdc)
- Bomes de raccordement du système.
 \sim, \sim : alimentation (12 Vac/Vdc).
 $+, -$: alimentation (18 Vcc).
1, 2, 3, 6: communs d'audio
Cp1: fil commun des boutons-poussoirs double tonalité
Cp2: fil commun des boutons-poussoirs une seule tonalité
C, No: connexion gâche électrique
- : raccordement bouton-poussoir

D Anschlüsse Türstation:

- Video-Klemmen (Koaxial)
V: Kern
M: Schirm
Ct: Aktivierung der Kamera (10 VDC)
- Anschlussklemmen des Systems:
 \sim, \sim : Stromversorgung (12 Vac/Vdc).
+18, -: Stromversorgung (18 VDC)
1, 2, 3, 6: gemeinsame
Cp1: Gemeinsamer Leiter Tasten mit Doppelton
Cp2: Gemeinsamer Leiter Tasten mit Einfachton
C, No: Verbindung Türöffner
- : Anschluss Taste

Pag 8

G)

- E** Enfoque la telecámara
- EN** Focus the camera
- F** Réglez la caméra vidéo
- D** Richten Sie die Kamera aus
- P** Foque a telecámara.

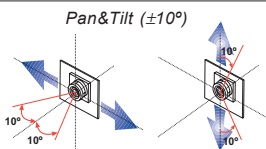

H)

E Conectores Placa:

- Bomas de video, (coaxial).
V: vivo
M: malla
Ct: activación telecamara (10 Vdc)
- Bomas de Conexión del sistema:
 \sim, \sim : alimentación (12 Vac/Vdc).
+18, -: alimentación (18 Vdc).
1, 2, 3, 6: comunes audio
Cp1: común de pulsadores doble tono
Cp2: común de pulsadores simple tono
C, No: conexión abrepuertas.
- : conexión Pulsador.

EN Panel Connectors:

- Video terminals (coaxial):
V: live
M: shield
Ct: camera activation (10 Vdc)
- System connection terminals:
 \sim, \sim : power supply (12 Vac/Vdc).
+18, -: power supply (18 Vdc).
1, 2, 3, 6: commons for audio
Cp1: double tone button common wire
Cp2: single tone button common wire
C, No: door-opener connection
- : Button Connection.

F Connecteurs platine:

- Bomes vidéo (câble coaxial).
V: vif
M: maille
Ct: activation caméra (10 Vdc)
- Bomes de raccordement du système.
 \sim, \sim : alimentation (12 Vac/Vdc).
 $+, -$: alimentation (18 Vcc).
1, 2, 3, 6: communs d'audio
Cp1: fil commun des boutons-poussoirs double tonalité
Cp2: fil commun des boutons-poussoirs une seule tonalité
C, No: connexion gâche électrique
- : raccordement bouton-poussoir

D Anschlüsse Türstation:

- Video-Klemmen (Koaxial)
V: Kern
M: Schirm
Ct: Aktivierung der Kamera (10 VDC)
- Anschlussklemmen des Systems:
 \sim, \sim : Stromversorgung (12 Vac/Vdc).
+18, -: Stromversorgung (18 VDC)
1, 2, 3, 6: gemeinsame
Cp1: Gemeinsamer Leiter Tasten mit Doppelton
Cp2: Gemeinsamer Leiter Tasten mit Einfachton
C, No: Verbindung Türöffner
- : Anschluss Taste

Pag 8

● Conectores de Placa:

- Terminais de vídeo (coaxial).
V: vivo
M: malha
Ct: activação telecâmara (10 Vdc)
- Terminais de ligação do sistema:
~, -: alimentação (12 Vac/Vdc).
+18, - : alimentação (18 Vdc).
1, 2, 3, 6: comuns de áudio
Cp1: comum para botões de som duplo
Cp2: comum para botões de som simples
- C, No: ligação do trinco
- : ligação do botão

I)

- Modelo del amplificador
- Amplifier model
- Modèle d'amplificateur
- Lautsprechermodell
- Modelo do amplificador

J)

MIC

●	Conexión micrófono (micrófono ubicado en el perfil inferior de la placa)
●	Microphone connection (microphone located in the lower panel profile)
●	Connexion microphone (microphone placé sur le profil inférieur de la platine)
●	Mikrofonanschluss (Mikrofon befindet sich am unteren Profil der Türstation)
●	Ligação do microfone (microfone localizado no perfil inferior da placa)

K)

TEST

●	Video Test monitor	Conector de test y programación de monitores
●	Video test monitor	Test and monitor programming connector
●	Écran de Test Vidéo	Connecteur de test et programmation d'écrans
●	Video Testmonitor	Testanschluss und Monitorprogrammierung
●	Video Test monitor	Conector de teste e programação de monitores

Pag 9

● Conectores de Placa:

- Terminais de vídeo (coaxial).
V: vivo
M: malha
Ct: activação telecâmara (10 Vdc)
- Terminais de ligação do sistema:
~, -: alimentação (12 Vac/Vdc).
+18, - : alimentação (18 Vdc).
1, 2, 3, 6: comuns de áudio
Cp1: comum para botões de som duplo
Cp2: comum para botões de som simples
- C, No: ligação do trinco
- : ligação do botão

I)

- Modelo del amplificador
- Amplifier model
- Modèle d'amplificateur
- Lautsprechermodell
- Modelo do amplificador

J)

MIC

●	Conexión micrófono (micrófono ubicado en el perfil inferior de la placa)
●	Microphone connection (microphone located in the lower panel profile)
●	Connexion microphone (microphone placé sur le profil inférieur de la platine)
●	Mikrofonanschluss (Mikrofon befindet sich am unteren Profil der Türstation)
●	Ligação do microfone (microfone localizado no perfil inferior da placa)

K)

TEST

●	Video Test monitor	Conector de test y programación de monitores
●	Video test monitor	Test and monitor programming connector
●	Écran de Test Vidéo	Connecteur de test et programmation d'écrans
●	Video Testmonitor	Testanschluss und Monitorprogrammierung
●	Video Test monitor	Conector de teste e programação de monitores

Pag 9

4+n Panels

FERMAX

E PRECABLEADO **EN** INTERNAL WIRING **F** PRECÂBLAGE **D** VERKABELUNG
P PRE-CABLAGE

- E** Placa Perfil continuo
- EN** Continuous profile panel
- F** Platine Profil continu
- D** Türstation mit durchgehendem Profil
- P** Placa de Perfil Continuo

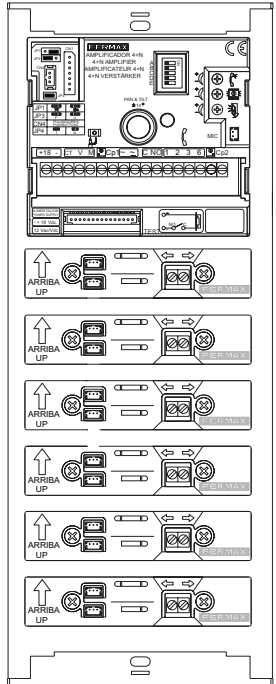
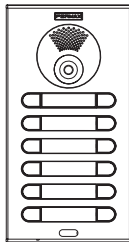

4+n Panels

FERMAX

E PRECABLEADO **EN** INTERNAL WIRING **F** PRECÂBLAGE **D** VERKABELUNG
P PRE-CABLAGE

- E** Placa Perfil continuo
- EN** Continuous profile panel
- F** Platine Profil continu
- D** Türstation mit durchgehendem Profil
- P** Placa de Perfil Continuo

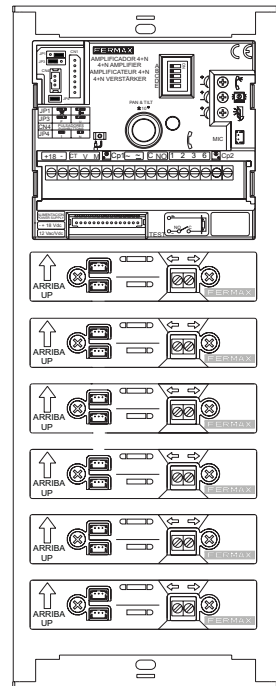
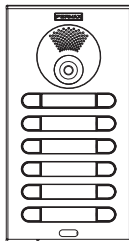

Detalle de cableado de los Pulsadores de la placa a los teléf./monit. de las viviendas
Panel's pushbuttons wiring details to the telephones/monitors on the dwellings
Détail de câblé des Boutons de la platine aux téléphones/monitors des maisons
Detail der Verdrahtung vom Taster von der Türstation zu den Telef./Monit. der Wohnung
Detalhe de cablagem dos botões da placa aos telefone/monitores das vivendas.

(*)

- E** Hilo de Llamada: cablear al conector nº 4 del terminal de la vivienda correspondiente.
- EN** Call Wire: to be wired to connector nº 4 of the corresponding residence's terminal.
- F** Fil d'appel : câbler au connecteur nº 4 du terminal du logement correspondant.
- D** Rufdraht: Mit Anschluss Nr. 4 der entsprechenden Wohnungssprechstelle verkabeln.
- P** Fio de Chamada: ligar por cabo ao conector nº 4 do terminal da vivenda correspondente.

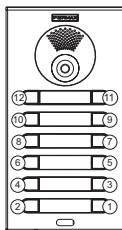
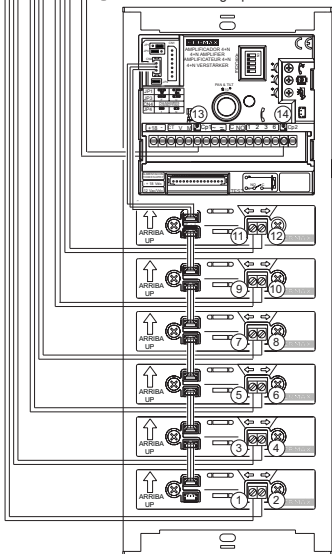

Pag 11

Detalle de cableado de los Pulsadores de la placa a los teléf./monit. de las viviendas
Panel's pushbuttons wiring details to the telephones/monitors on the dwellings
Détail de câblé des Boutons de la platine aux téléphones/monitors des maisons
Detail der Verdrahtung vom Taster von der Türstation zu den Telef./Monit. der Wohnung
Detalhe de cablagem dos botões da placa aos telefone/monitores das vivendas.

(*)

- E** Hilo de Llamada: cablear al conector nº 4 del terminal de la vivienda correspondiente.
- EN** Call Wire: to be wired to connector nº 4 of the corresponding residence's terminal.
- F** Fil d'appel : câbler au connecteur nº 4 du terminal du logement correspondant.
- D** Rufdraht: Mit Anschluss Nr. 4 der entsprechenden Wohnungssprechstelle verkabeln.
- P** Fio de Chamada: ligar por cabo ao conector nº 4 do terminal da vivenda correspondente.

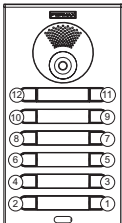
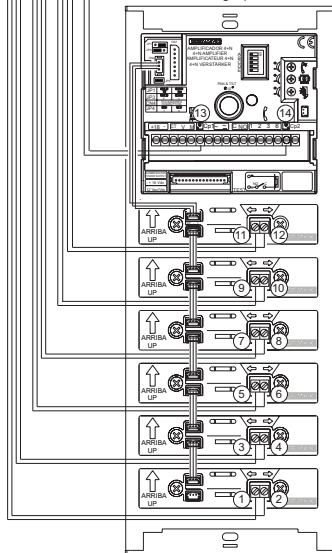

Pag 11

VIDEO

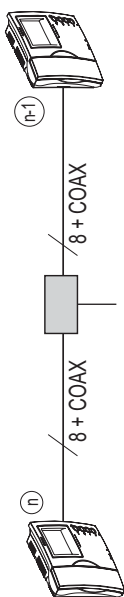

VIDEO

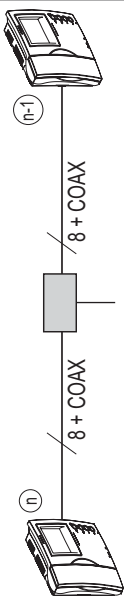

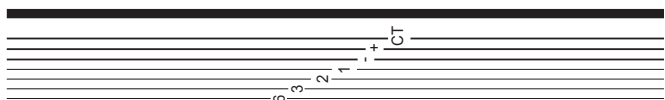
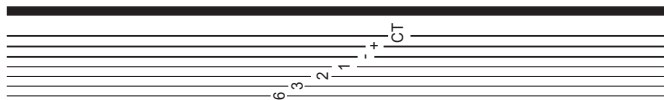

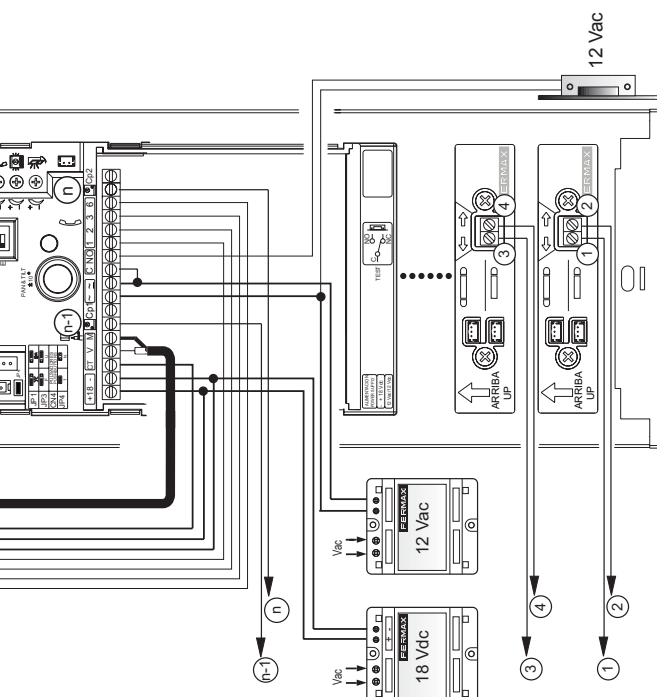
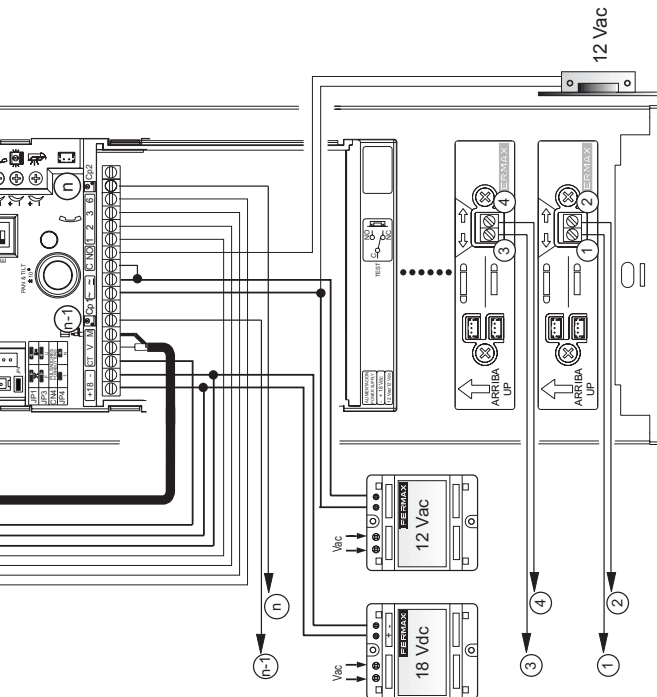

E Monitores

EN Monitors

F Moniteurs

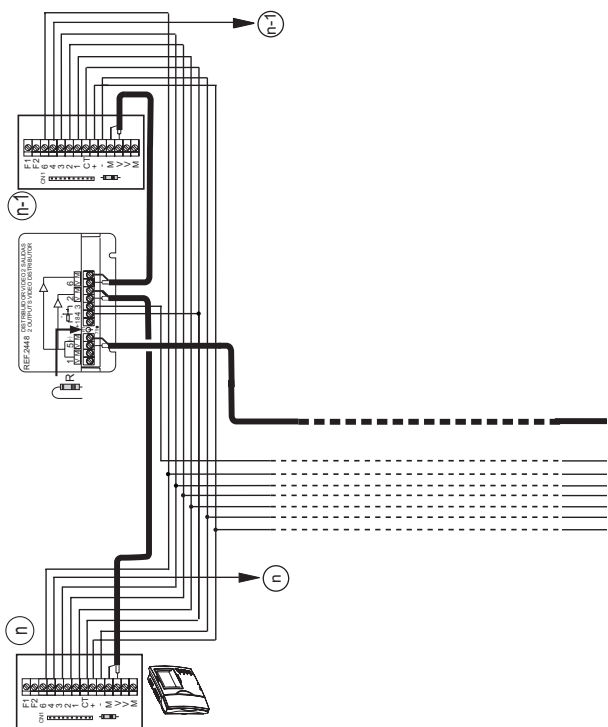

E Monitores

EN Monitors

F Moniteurs

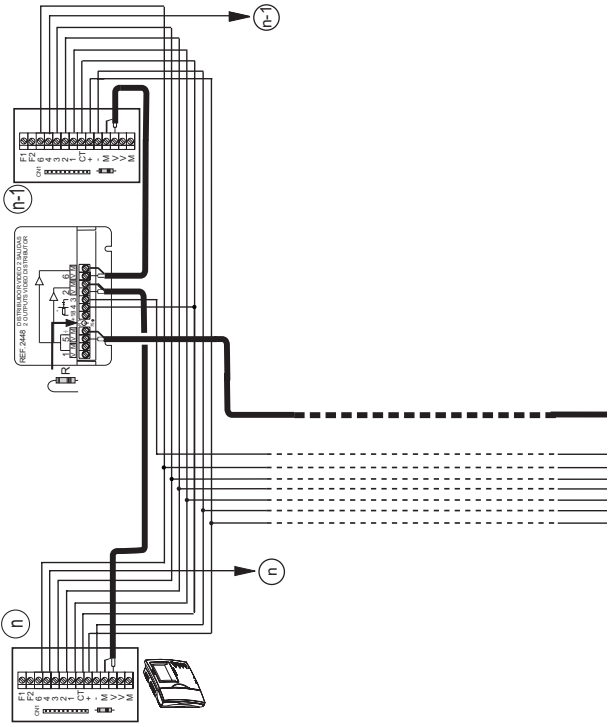

● Monitore

● Monitores

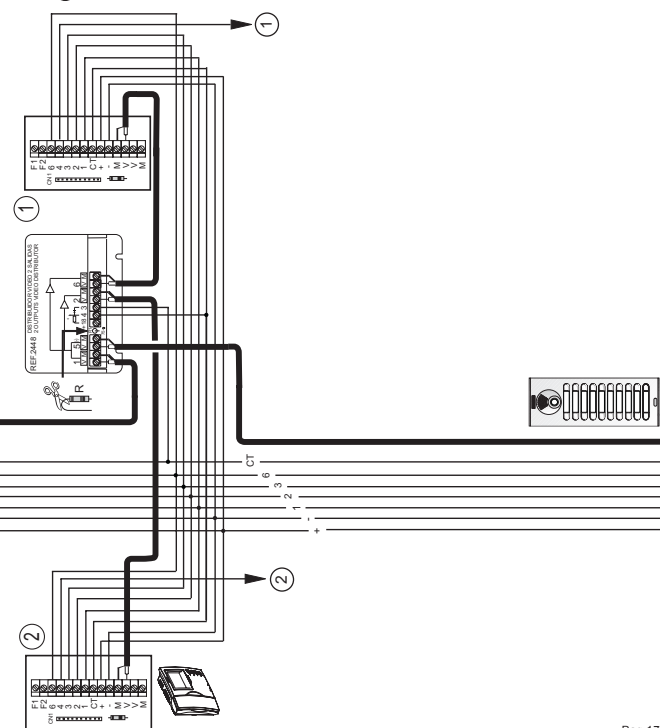

● Monitore

● Monitores

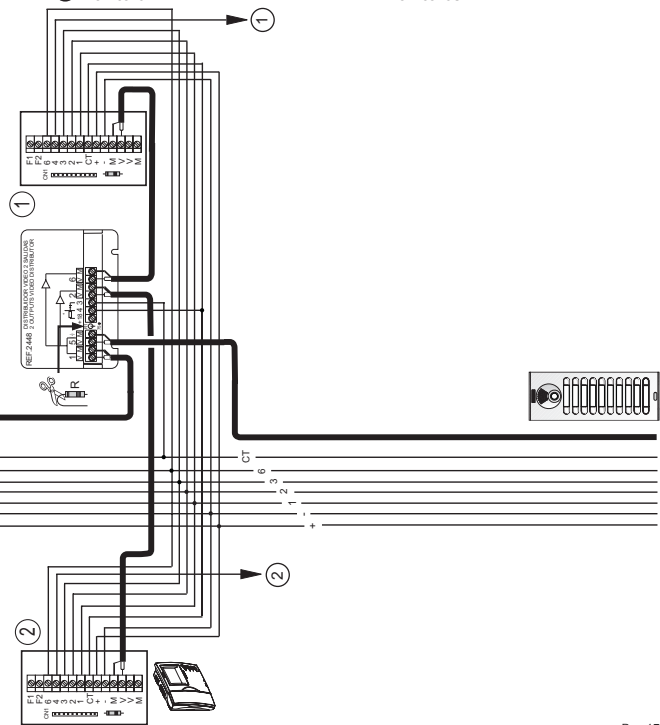

AUDIO

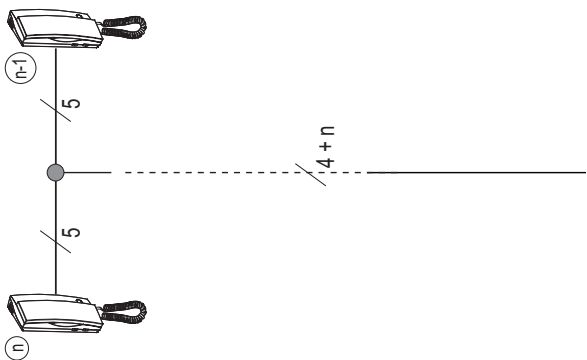

AUDIO

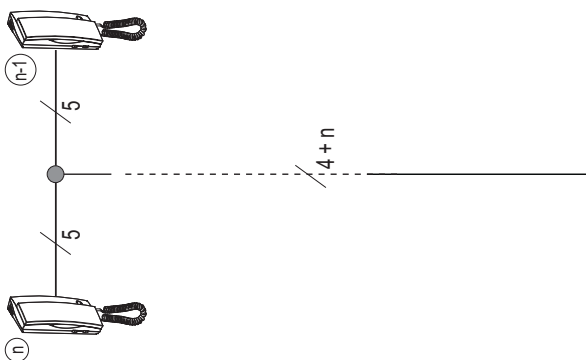

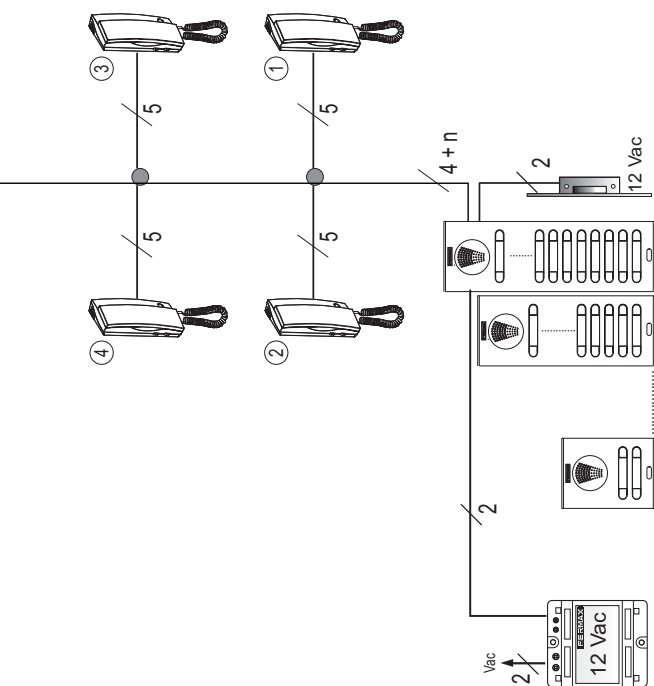
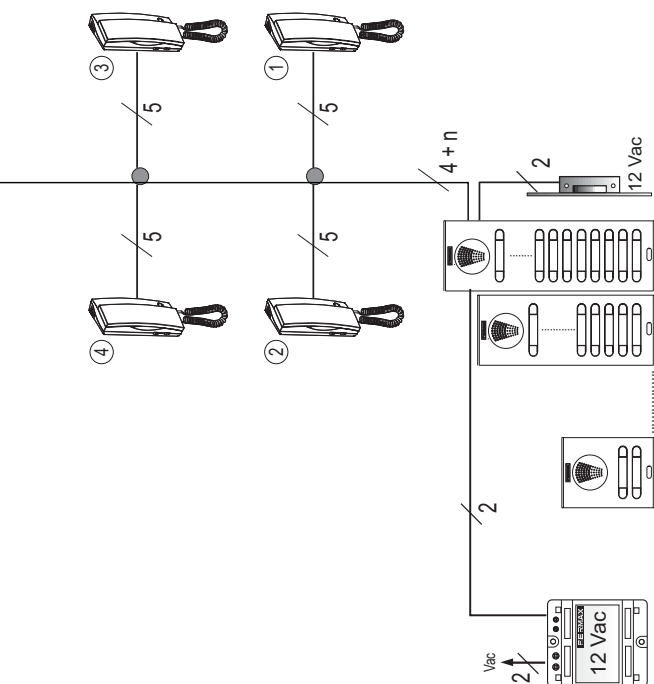

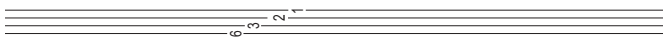
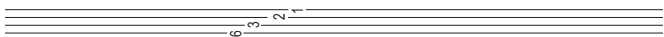

E Teléfonos

EN Telephones

F Postes

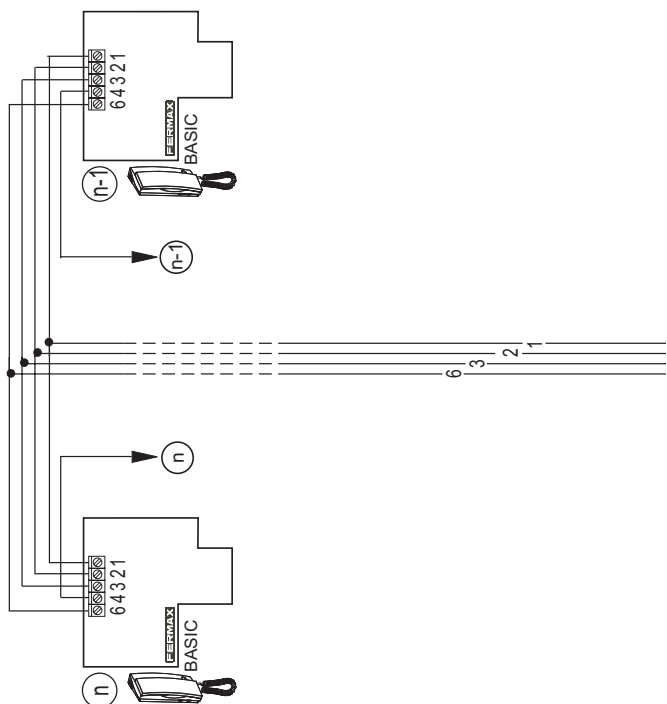

E Teléfonos

EN Telephones

F Postes

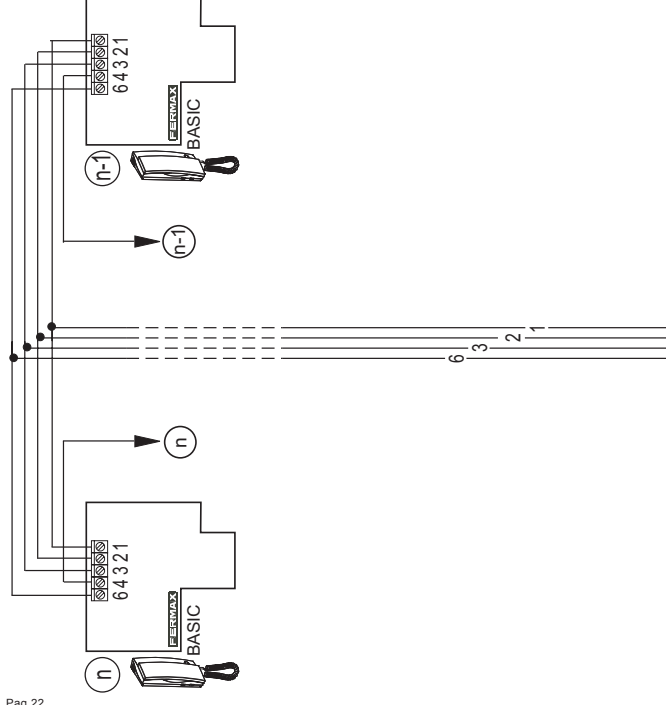

D Telefon

P Telefonos

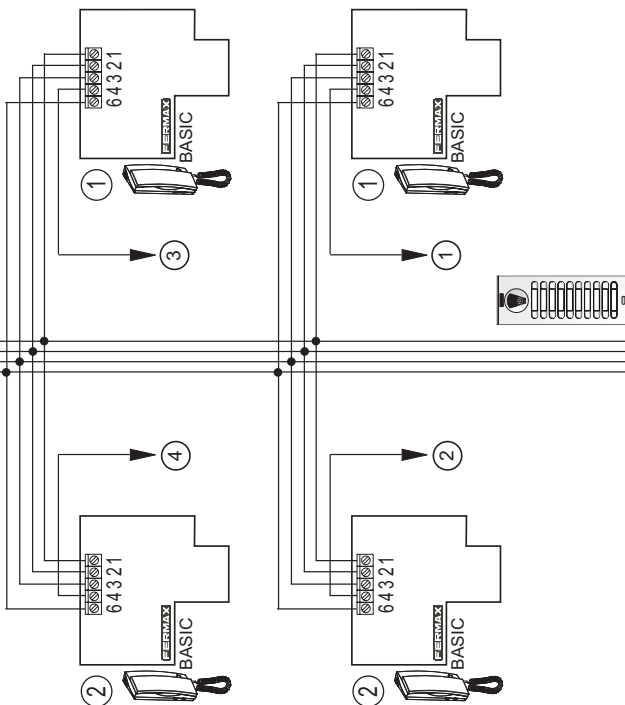

D Telefon

P Telefonos

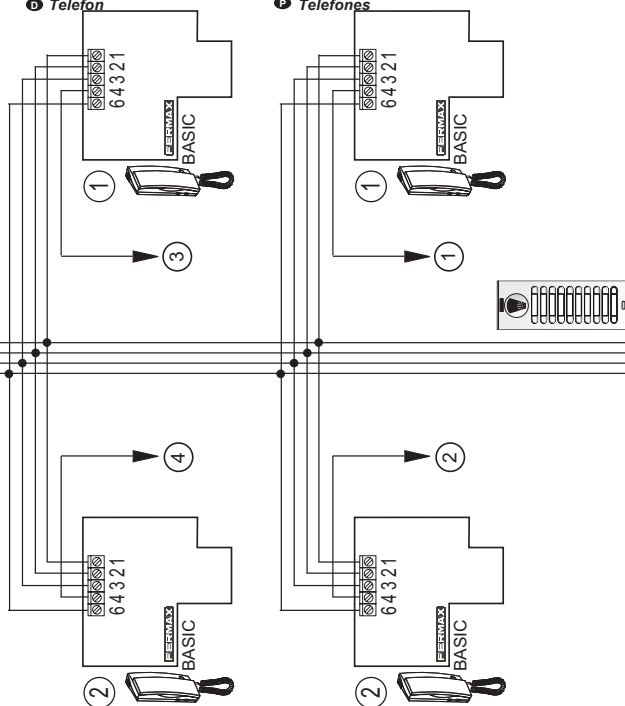

E CARACTERÍSTICAS TÉCNICAS

EN TECHNICAL FEATURES

F CARACTERISTIQUES TECHNIQUES

D TECHNISCHE EIGENSCHAFTEN

P CARACTERÍSTICAS TÉCNICAS

	Alimentación - <i>Power Supply</i> - Alimentation <i>Stromversorgung</i> - Alimentação	AUDIO	12 Vac
		VIDEO	18 Vdc
	Consumo - Consumption - Consommation <i>Stromverbrauch</i> - Consumo		
	en reposo - <i>in standby</i> - au repos - <i>Im Bereitschaftsmodus</i> - em repouso		185 mA
	audio activo - audio active - avec audio - Audioverbindung - áudio activo		460 mA
	cámara - camera - caméra - Kamera - câmara		180 mA
IP43 IK07	iluminación - lighting - éclairage - Beleuchtung - iluminação		35 mA
	Potencia audio sentido vivienda-calle - <i>Audio power from the apartment to the panel</i> Puissance de l'audio sens poste-platine - <i>Audio-Leistung in Richtung Türstation</i> Potência áudio sentido rua		1 W
	Potencia audio sentido calle-vivienda - <i>Audio power from the panel to the apartment</i> Puissance de l'audio sens platine-poste - <i>Audio-Leistung in Richtung Telefon</i> Potência áudio sentido telefone		0,15 W
	Volumen regulable en ambos sentidos - <i>Adjustable volume both ways</i> Volume réglable dans les deux sens - <i>Regulierbare Lautstärke in beiden Richtungen</i> Volume regulável em ambos os sentidos		
	Temperatura de funcionamiento - <i>Operating Temperature</i> Température de fonctionnement - <i>Betriebstemperatur</i> Temperatura de funcionamento		[-10 , +60 °C] [14, 140°F]

E CARACTERÍSTICAS TÉCNICAS

EN TECHNICAL FEATURES

F CARACTERISTIQUES TECHNIQUES

D TECHNISCHE EIGENSCHAFTEN

P CARACTERÍSTICAS TÉCNICAS

	Alimentación - <i>Power Supply</i> - Alimentation <i>Stromversorgung</i> - Alimentação	AUDIO	12 Vac
		VIDEO	18 Vdc
	Consumo - Consumption - Consommation <i>Stromverbrauch</i> - Consumo		
	en reposo - <i>in standby</i> - au repos - <i>Im Bereitschaftsmodus</i> - em repouso		185 mA
	audio activo - audio active - avec audio - Audioverbindung - áudio activo		460 mA
	cámara - camera - caméra - Kamera - câmara		180 mA
IP43 IK07	iluminación - lighting - éclairage - Beleuchtung - iluminação		35 mA
	Potencia audio sentido vivienda-calle - <i>Audio power from the apartment to the panel</i> Puissance de l'audio sens poste-platine - <i>Audio-Leistung in Richtung Türstation</i> Potência áudio sentido rua		1 W
	Potencia audio sentido calle-vivienda - <i>Audio power from the panel to the apartment</i> Puissance de l'audio sens platine-poste - <i>Audio-Leistung in Richtung Telefon</i> Potência áudio sentido telefone		0,15 W
	Volumen regulable en ambos sentidos - <i>Adjustable volume both ways</i> Volume réglable dans les deux sens - <i>Regulierbare Lautstärke in beiden Richtungen</i> Volume regulável em ambos os sentidos		
	Temperatura de funcionamiento - <i>Operating Temperature</i> Température de fonctionnement - <i>Betriebstemperatur</i> Temperatura de funcionamento		[-10 , +60 °C] [14, 140°F]

4+n Panels

FERMAX

- E** TABLAS SECCIONES DISTANCIAS **EN** TABLES SECTIONS DISTANCES
P TABELAS DE SECÇÕES E DISTÂNCIAS **F** TABLEAUX SECTIONS DISTANCES
D TABELLE MIT DEN QUERSCHNITTEN UND DISTANZEN

- E** Instalaciones: AUDIO
EN Systems: AUDIO
P Instalações: ÁUDIO
F Installations : AUDIO
D Anlagen: AUDIO
P Instalações: ÁUDIO

metros / metres	pies / feet	mm ²	AWG	mm ²	AWG
0 - 100	3 - 300	0,5mm ²	20	1 mm ²	17
100 - 300	300 - 900	1 mm ²	17	1 mm ²	17

- E** Instalaciones: VIDEO
EN Systems: VIDEO
F Installations : VIDÉO
D Anlagen: VIDEO
P Instalações: VÍDEO

metros/metros	pies/feet	mm ²	AWG	mm ²	AWG	
0 - 100	0 - 300	0,5 mm ²	20	1 mm ²	17	75 Ohm
100 - 300	300 - 900	1 mm ²	17	1 mm ²	17	75 Ohm

Pag 25

4+n Panels

FERMAX

- E** TABLAS SECCIONES DISTANCIAS **EN** TABLES SECTIONS DISTANCES
P TABELAS DE SECÇÕES E DISTÂNCIAS **F** TABLEAUX SECTIONS DISTANCES
D TABELLE MIT DEN QUERSCHNITTEN UND DISTANZEN

- E** Instalaciones: AUDIO
EN Systems: AUDIO
P Instalações: ÁUDIO
F Installations : AUDIO
D Anlagen: AUDIO
P Instalações: ÁUDIO

metros / metres	pies / feet	mm ²	AWG	mm ²	AWG
0 - 100	3 - 300	0,5mm ²	20	1 mm ²	17
100 - 300	300 - 900	1 mm ²	17	1 mm ²	17

































- E** Instalaciones: VIDEO
EN Systems: VIDEO
F Installations : VIDÉO
D Anlagen: VIDEO
P Instalações: VÍDEO

metros/metros	pies/feet	mm ²	AWG	mm ²	AWG	
0 - 100	0 - 300	0,5 mm ²	20	1 mm ²	17	75 Ohm
100 - 300	300 - 900	1 mm ²	17	1 mm ²	17	75 Ohm

Pag 25

































**SINTETIZADOR DE VOZ
VOICE SYNTHESIZER
SYNTHETISEUR VOCAL
SPRACHSYNTHESIZER**

 **CODIFICACIÓN IDIOMAS (Ver tabla)**
LANGUAGE CODING (see table)
CODIFICATION LANGUES (voir tableau)
SPRACHKODIERUNG (siehe Tabelle)

 0	 1	 2	 3	 4	 5	 6	 7
 8	 9	 10	 11	 12	 13	 14	 15
 16	 17	 18	 19	 20	 21	 22	 23
 24	 25	 26	 27	 28	 29	 30	 31

**SINTETIZADOR DE VOZ
VOICE SYNTHESIZER
SYNTHETISEUR VOCAL
SPRACHSYNTHESIZER**

 **CODIFICACIÓN IDIOMAS (Ver tabla)**
LANGUAGE CODING (see table)
CODIFICATION LANGUES (voir tableau)
SPRACHKODIERUNG (siehe Tabelle)

 0	 1	 2	 3	 4	 5	 6	 7
 8	 9	 10	 11	 12	 13	 14	 15
 16	 17	 18	 19	 20	 21	 22	 23
 24	 25	 26	 27	 28	 29	 30	 31

CODE	ESPAÑOL	ENGLISH
0	castellano	Spanish
1	inglés	English
2	francés	French
3	holandés/flamenco	Dutch/Flemish
4	alemán	German
5	atalán	Catalan
6	valenciano	Valencian
7	balear	Balearic
8	portugués	Portuguese
9	euskera	Basque
10	gallego	Galician
11	griego	Greek
12	polaco	Polish
13	checo	Czech
14	eslovaco	Slovak
15	turco	Turkish

CODE	ESPAÑOL	ENGLISH
0	castellano	Spanish
1	inglés	English
2	francés	French
3	holandés/flamenco	Dutch/Flemish
4	alemán	German
5	atalán	Catalan
6	valenciano	Valencian
7	balear	Balearic
8	portugués	Portuguese
9	euskera	Basque
10	gallego	Galician
11	griego	Greek
12	polaco	Polish
13	checo	Czech
14	eslovaco	Slovak
15	turco	Turkish

CODE	ESPAÑOL	ENGLISH
16	chino	Chinese
17	persa/farsi	Persian/Farsi
18	árabe	Arabic
19	noruego	Norwegian
20	finés	Finnish
21	sueco	Swedish
22	danés	Danish
23	islandés	Icelandic
24	ruso	Russian
25	italiano	Italian
26	hindi	Hindi
27	húngaro	Hungarian
28	hebreo	Hebrew
29		
30	Campana	Bell
31	DESACTIVADO	DEACTIVATED

CODE	ESPAÑOL	ENGLISH
16	chino	Chinese
17	persa/farsi	Persian/Farsi
18	árabe	Arabic
19	noruego	Norwegian
20	finés	Finnish
21	sueco	Swedish
22	danés	Danish
23	islandés	Icelandic
24	ruso	Russian
25	italiano	Italian
26	hindi	Hindi
27	húngaro	Hungarian
28	hebreo	Hebrew
29		
30	Campana	Bell
31	DESACTIVADO	DEACTIVATED

FERMAX

FERMAX