

VEO XL



FERMAX

KIT VIDEO DUOX PLUS CITYLINE VEO XL WIFI
DUOX PLUS CITYLINE WIFI VEO XL VIDEO KIT
KIT VIDÉO DUOX PLUS CITYLINE VEO XL WIFI
DUOX PLUS CITYLINE WIFI VEO XL VIDEO-SET
KIT VÍDEO DUOX PLUS CITYLINE VEO XL WIFI

GUÍA INICIO RÁPIDA
QUICK START GUIDE
GUIDE DE MISE EN MARCHÉ RAPIDE
SCHNELLSTARTANLEITUNG
GUIA DE INICIAÇÃO RAPIDA

(es.)

(en.)

(fr.)

(de.)

(pt.)

(pl.)

✂ INSTALACIÓN

INSTALACIÓN DE LA PLACA EN LA CALLE Y DEL MONITOR

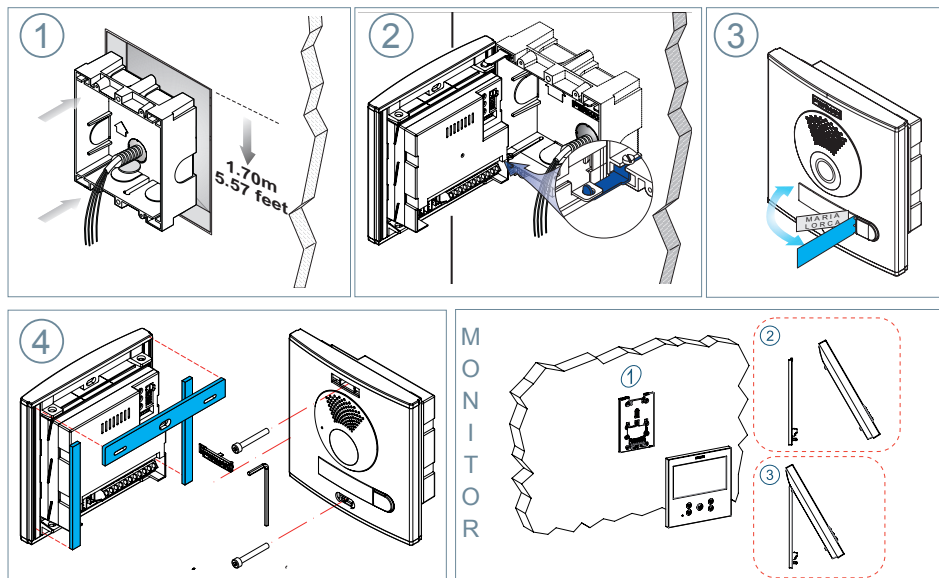

📶 CONFIGURACIÓN





MONITOR VEO XL WIFI DUOX PLUS

El monitor suministrado en el kit YA SALE PROGRAMADO de fábrica.

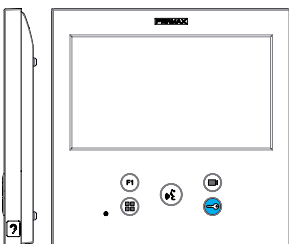
En el caso del kit de 2 líneas ambos monitores SALEN PROGRAMADOS.

BOTONES CONTROL



-  Menú digital para ajustes y configuración de parámetros internos. (Si el monitor está programado).
-  En conversación, pulsar para abrir la puerta.
-  En reposo, llamada al conserje (si existe conserjería).
-  Función auxiliar (consulte con su instalador).
En reposo, pulsar y se visualiza en pantalla la posibilidad de realizar autoencendido con diferentes placas. Pulsando secuencialmente Placa 0, Placa 1, Placa General, (según disponibilidad de placas).
-  Activación de audio y colgado (funcionamiento manos libres).

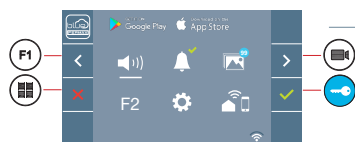

El monitor VEO XL WIFI incorpora un menú OSD que se gestiona a través de los pulsadores del monitor. Los iconos visualizados en pantalla se manejan con los pulsadores correspondientes ubicados en el monitor.

La línea blanca abajo del icono indica en la función en la que nos encontramos.



Seleccionar con  /  el icono deseado y confirmar con .



AJUSTES

1. AJUSTES DE MONITOR

AJUSTES VÍDEO

Teniendo imagen en el monitor al pulsar el botón , (o al recibir una llamada sin establecer comunicación), pulsar la tecla  para mostrar los **ajustes de video**.

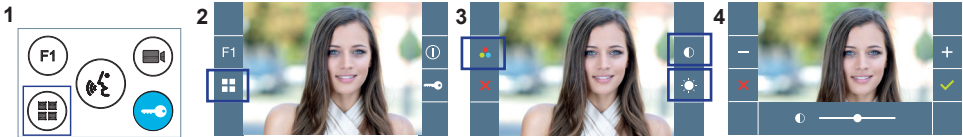



Seleccionar la opción del ajuste e ir aumentando o decrementando con  y .

AJUSTES AUDIO

Durante el tiempo que está abierto el canal de audio pulsar el botón  y aparecerá en pantalla el menú para dicho ajuste.



Ir aumentando o decrementando con  y , hasta obtener la regulación deseada.

Nota: Tiempo de conversación máximo: 90 segundos.

2. AJUSTES PLACAS

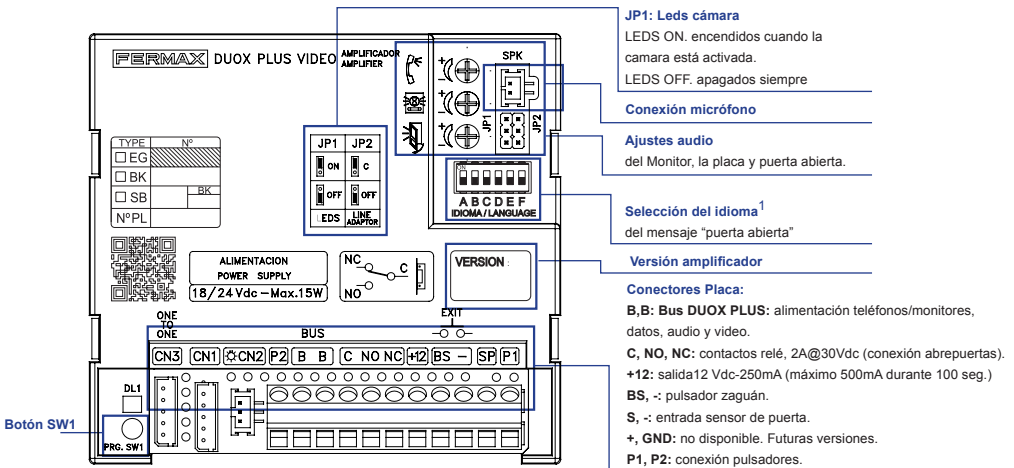

¹ Selección del idioma del mensaje "puerta abierta"

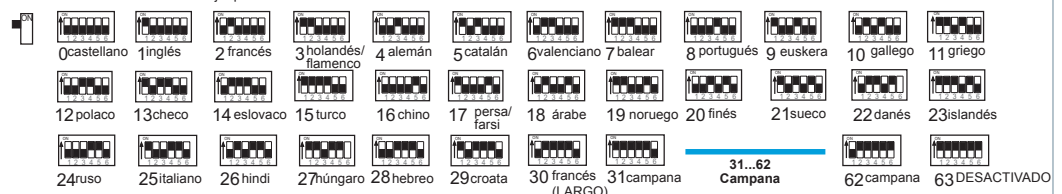

3. CODIFICAR PLACAS*

Siempre que exista más de una placa, sera necesario programar el número de placas.

4. ENFOQUE DE LA CÁMARA / TIEMPO ACTIVACIÓN DEL ABREPUERTAS*

Para ajustar la imagen de la cámara o ajustar el tiempo de activación del abrepuertas.

* Ver Configuración asistida por voz en placas de pulsadores cod. 970048. Instrucción incluida en este equipo.

CARACTERÍSTICAS TÉCNICAS

CARACTERÍSTICAS TÉCNICAS PLACA

Alimentación	18-24 Vdc
Consumo en reposo	2,86 W
Consumo audio activo	6,30 (max) W
Potencia audio sentido vivienda-calle	1 W
Potencia audio sentido calle-vivienda	0,15 W
Temperatura de funcionamiento	[-25° , +70°C] / [-13° , 158°F]
Volumen regulable en ambos sentidos	

VALORES PLACA

Tiempo activación abrepuertas	01...99 seg. (por defecto: 03)
Tiempo activación botón salida	00...99 seg. (por defecto: 06) / (desactivado: 00)
Tipo de placa	sub-bloque/bloque/entrada general. (por defecto: bloque)
Número de placa	0...9 (por defecto: 00)

Placa MÁSTER

CARACTERÍSTICAS TÉCNICAS MONITOR (Pantalla OSD TFT 7")

Alimentación	18-24 Vdc
Consumo en reposo (emparejado y conectado)	1,3 W
Consumo máximo	9,9 W
Temperatura de funcionamiento	[-5° , +40°C] / [23° , 104°F]



ESQUEMAS

TABLA SECCIONES - DISTANCIAS

Tablas secciones distancias - INSTALACIÓN DE KITS de VIDEO

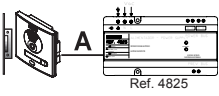
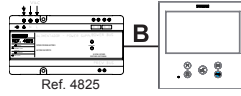
SECCIÓN CABLE			
	TERMINALES por vivienda sin fuentes adicionales	Distancia máxima (A) Fuente/Filtro hasta Placa (Placa-Abrepuertas) (i)	Distancia máxima (B) Fuente/Filtro hasta el Terminal más alejado
2 x 1 mm ²	1	250	250
	2		200
	3		150
2 x 0,5 mm ²	1	200	200
	2		120
	3		70
2 x 0,2 mm ²	1	80	100
	2		50
	3		30

- (i) Para abrepuertas de 12Vdc y consumo máx. 250mA, alimentador desde el amplificador.

Nota: Para un funcionamiento óptimo, se recomienda utilizar el mismo tipo de cable para toda la instalación. No duplicar hilos.

ESQUEMA CABLEADO KIT 1 LÍNEA

Ejemplo: Conexión de abrepuertas de corriente continua.

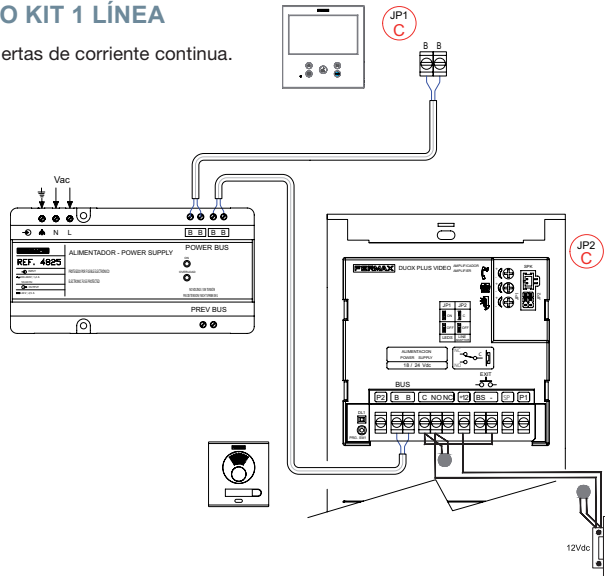

ESQUEMA CABLEADO KIT 2 LÍNEAS

Ejemplo: Conexión abrepuertas de corriente alterna.

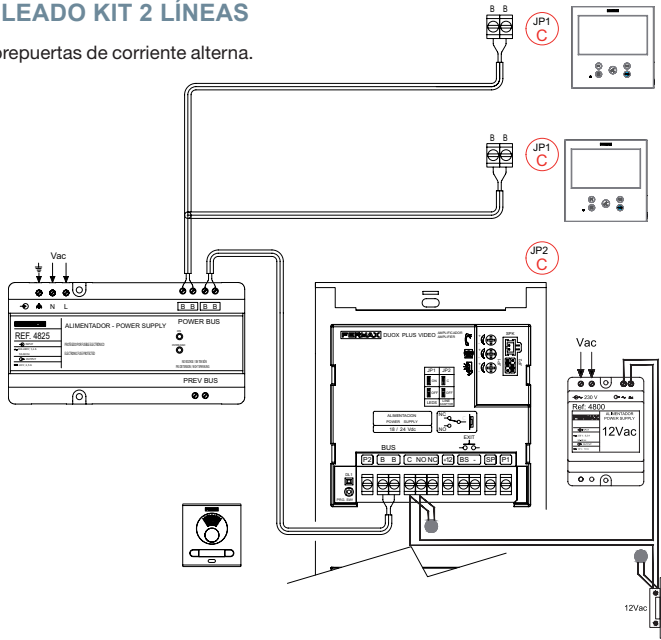

Nota: Este documento muestra los conceptos más básicos para la rápida puesta en marcha, para más información descargar los manuales en www.fermax.com

- Placas Cityline Video Duox Plus cod. 970050.
- Monitor Duox PlusVeo XL WIFI cod. 970164.
- Libro Técnico Duox Plus cod. 970122.

AJUSTES DE USUARIO

1. EMPAREJAMIENTO. Desvío de llamada.

El monitor VEO XL WIFI DUOX PLUS permite acceder a nuevos servicios ofrecidos por Fermax a través de su propia nube como el de desvío de llamada. Para poder disfrutar de dicho servicio el primer paso es conectar el monitor a Internet mediante el proceso llamado de emparejamiento.

Para ello es preciso usar la app Blue que está disponible en Google Play o Apple Store.

Ajustes del monitor. Proceso de emparejamiento.

Con ayuda de la app Blue y una vez registrado el usuario y logueado podemos empezar el proceso de emparejamiento del monitor.

El monitor DUOX PLUS sólo es compatible con WIFI 2,4GHz.

Pasos para conectar el monitor a internet.

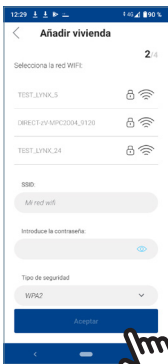
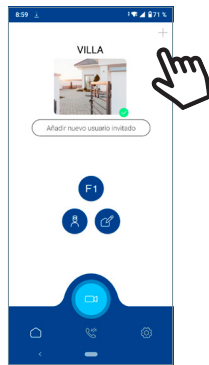

Android

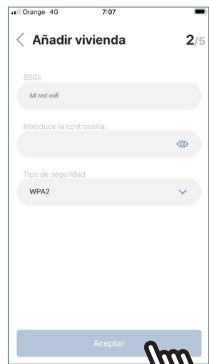

iOS

- 1 Abra la aplicación e inicie sesión.
- 2 Haga clic en el botón **+** en el centro de la pantalla por defecto o en la parte superior derecha si ya había algunas viviendas disponibles.

- 3 La aplicación requerirá que el usuario seleccione la red WIFI deseada para conectar el monitor.

Seleccione (en caso de Android) o introduzca (en caso de iOS) el SSID (nombre de la red) deseada, escriba la contraseña correcta para conectarse y haga clic en ACEPTAR.

- 4 La aplicación requerirá que el usuario abra el menú de conectividad en el monitor:



- 4a Pulsar el botón **MENÚ** , se accede a la pantalla del Menú de Usuario.

- 4b** Correspondencia entre pulsadores y menú de navegación. La línea blanca abajo del icono indica en la función en la que nos encontramos.
- 4c** Seleccionar el menú de conectividad en el monitor.

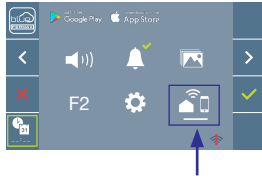

- 5** Una vez seleccionado el menú de conectividad, confirme con  para entrar en él.

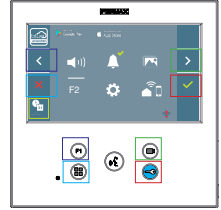

- 6** El monitor mostrará un código QR en la pantalla. Se proporciona la MAC en pantalla por si el router wifi tiene filtro de MAC.



- 7** La aplicación estará lista para escanear dicho código. Apunte al QR en la pantalla del monitor con el móvil alineando con el cuadrado verde en la pantalla del móvil.

- 8** La aplicación y el monitor comenzarán a sincronizarse entre sí. El led blanco WIFI del monitor comenzará a parpadear.

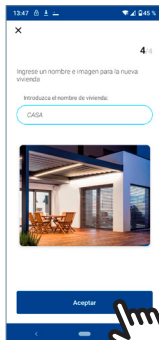
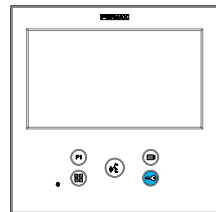
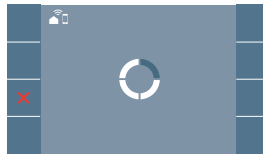

- 9** Se visualiza la pantalla para añadir la vivienda:
- Nombre
 - Imagen (opcional)
- Introducir datos y pulsar ACEPTAR.

- 11 Si la red WIFI y las credenciales proporcionadas son correctas, el monitor se conectará a Internet y el proceso se completará con éxito.

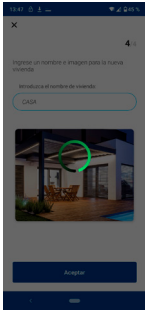

- 12 La aplicación mostrará la nueva vivienda vinculada como disponible y conectada (tick verde ✓) y el monitor mostrará el resultado de la conexión como exitoso. El led blanco WIFI permanecerá encendido ahora.

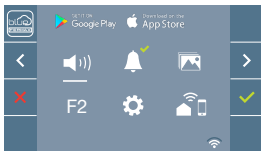

- 13 Una vez conectado, si se abre nuevamente el menú de usuario en el monitor, mostrará la intensidad de la señal WIFI en la parte inferior derecha.

Niveles de intensidad del icono de señal wifi mostrado en el menú:



Entre 0% y 20%
o monitor no emparejado.



Entre
20% y 40%



Entre
40% y 60%



Entre
60% y 80%



Entre
80% y 100%

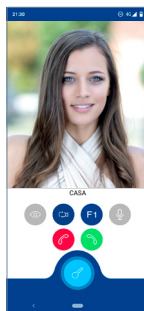

- 14 Para probar el desvío de llamadas, el usuario puede realizar un autoencendido y ver que se conecta con la placa de calle, (siempre y cuando no esté en uso).



Ajustes parámetros de usuario:



RESET DE USUARIO:

Un reset de usuario devuelve el estado del monitor a no emparejado (desconectado de Internet).

Nota: Este capítulo presenta los conceptos más básicos para la rápida puesta en marcha, para más información descargar el manual **Aplicación DUOX PLUS Blue para móvil cod. 970156** en www.fermax.com.

2. PARÁMETROS DE USUARIO: Acceder a la pantalla Parámetros de usuario.

1  2  3 



2.1 Ajustes Fecha y Hora



2.2 Captura Imágenes

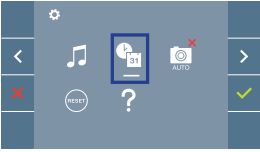

Seleccionar con  el icono  y confirmar con .





2.1 AJUSTES DE FECHA Y HORA

El monitor WIFI sincroniza la hora automáticamente con la zona horaria donde se encuentre instalado siempre que esté emparejado y conectado a Internet. En ese caso no se permite modificar la fecha ni la hora.

1  2  3 

Seleccionar con  el icono  y confirmar con .

Seleccionar con   el formato de fecha. Una vez seleccionada confirmar con .

Seleccionar la fecha y la hora con   y confirmar . Para navegar por los ajustes .

Fecha sin programar: 01/01/2019 (por defecto). El icono  aparecerá indicando que la fecha no es correcta (fecha por defecto). Al perder la alimentación vuelve a la fecha por defecto.

Nota: Si se captura una imagen con la fecha sin programar mostrará el icono .

Iconos de notificación de fecha sin programar:

Pantalla Menú de usuario

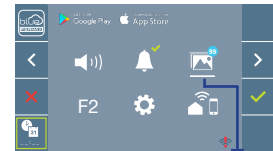

Visualización de imágenes

Pantalla Comunicación



Pantalla Visualización de imágenes

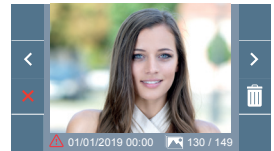



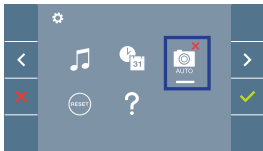
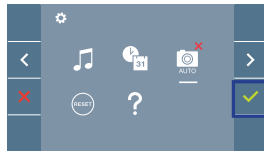
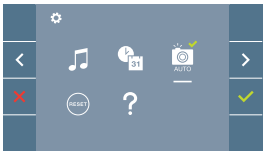

2.2 ACTIVACIÓN / DESACTIVACIÓN CAPTURA DE IMÁGENES

El monitor puede realizar una foto automática a los 3 segundos de recibir una llamada de una placa de calle. Por la legislación de protección de datos ((EU) 2016/679) de la Unión Europea puede restringirse la captura de imágenes. Por defecto está desactivada, se puede activar desde el monitor bajo su responsabilidad.

Así mismo podría obligar a colocar junto a la placa de calle un cartel indicando que el monitor puede capturar imágenes. Puede descargarlo en <https://www.fermax.com/spain/corporate/utilidades.html>.

1  2  3 

Seleccionar con  el icono  y confirmar con .

Pulsar  para activar/desactivar la función.

✂ INSTALLATION

INSTALLATION OF OUTDOOR PANEL AND MONITOR

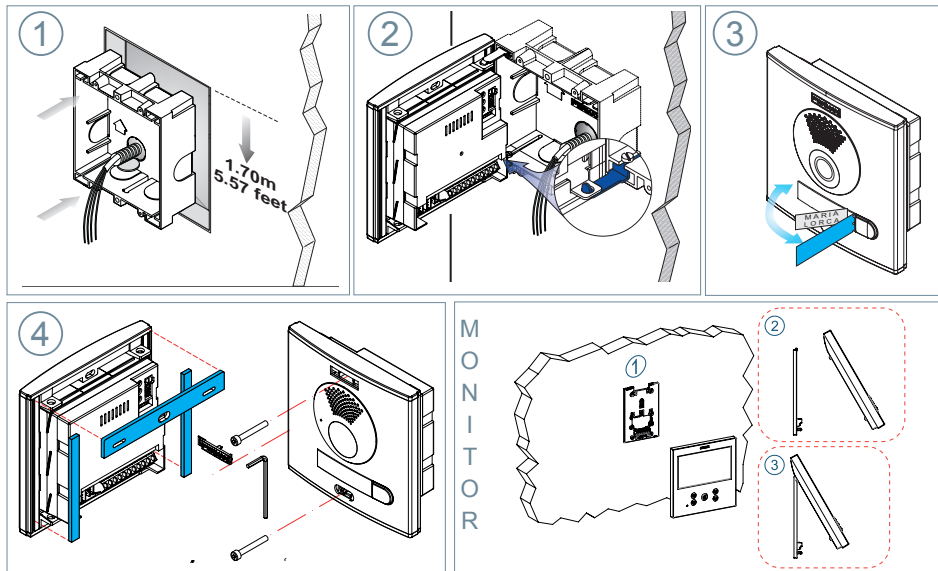





🏠 CONFIGURATION

WIFI VEO XL DUOX PLUS MONITOR

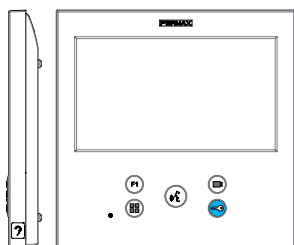
The monitor supplied in the kit comes **PRE-PROGRAMMED** from the factory.
If the kit has 2 lines, both monitors, they are **PRE-PROGRAMMED**.

CONTROL BUTTONS



-  Digital menu for internal parameter settings and configuration. (When the monitor has already been programmed)
-  In conversation, press to open the door.
In standby, call to guard unit (if applicable).
-  Auxiliary function, (contact your installer).
In standby, press and it displays the option of auto-on with different panels. By sequentially pressing Panel 0, Panel 1, General Panel, (depending on the available panels).
-  Audio activation and hang-up (hands-free functions).

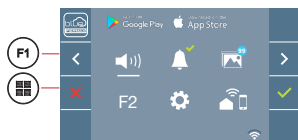



WIFI VEO XL monitor incorporates an OSD menu that is managed via the monitor's push buttons. The icons displayed are managed with the corresponding buttons located on the monitor.

The white line at the bottom of the icon indicates the function that is currently in effect.
Select with **>** / **<** the desired icon and confirm with **✓**.

SETTINGS

1. MONITOR SETTINGS

VIDEO SETTINGS

With an image on the monitor, by pressing the button , (or upon receiving a call without establish communication), press the  key to show the video settings.



AUDIO SETTINGS

While the audio channel is open, press the  button and a menu screen appears for this setting.

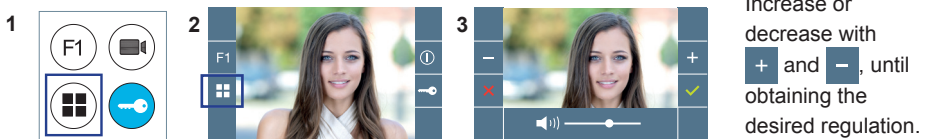

Notice: Maximum conversation time: 90 seconds.

2. PANEL SETTINGS

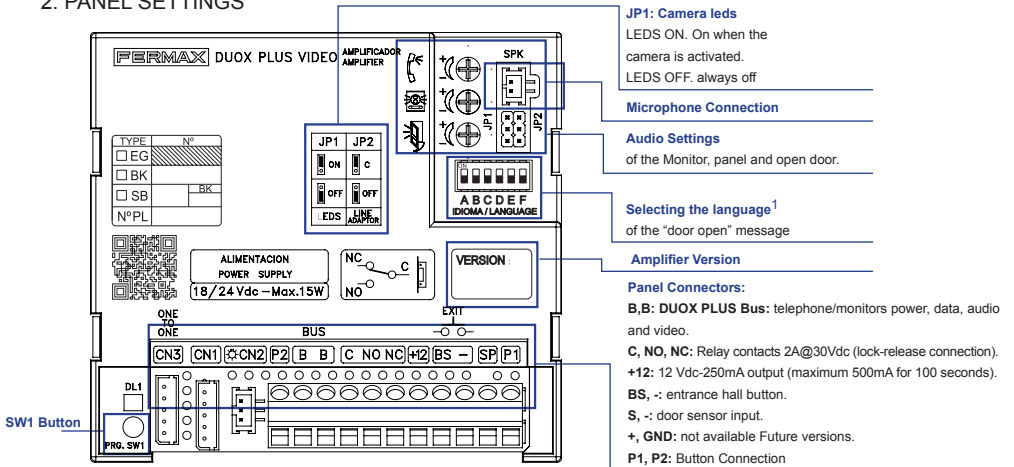

¹Door open¹ warning language selection

3. ENCODING PANELS*

Whenever there is more than one panel, you must program the number of panels.

4. CAMERA FOCUS / LOCK RELEASE ACTIVATION TIME*

To adjust the camera image or adjust the lock-release activation time.

* See Voice assisted configuration in button panels cod. 970048. Instructions included with this equipment.

TECHNICAL FEATURES

PANEL TECHNICAL CHARACTERISTICS

Power Supply	18-24 Vdc
Standby Consumption	2,86 W
Audio active consumption	6,30 (max) W
Audio Power in Residence - Entry Panel Direction	1 W
Audio Power in Entry Panel - Residence Direction	0,15 W
Operating temperature	[-25° , +70°C] / [-13°, 158°F]
Volume can be Regulated in Both Directions.	

PANEL VALUES

Lock-release activation time	01...99 sec. (Default: 03)
Exit button activation time	00...99 sec. (Default: 06) / (deactivated: 00)
Panel type	sub-block/block/general entrance. (Default: block)
Panel number	0..9 (by default: 00)
MASTER panel	

MONITOR TECHNICAL CHARACTERISTICS (OSD TFT 7" Screen)

Power supply	18-24 Vdc
Standby consumption (paired and connected)	1,3 W
Maximum consumption	9,9 W
Operating temperature	[-5° , +40°C] / [23° , 104°F]

WIRING DIAGRAMS

SECTIONS-DISTANCES TABLE

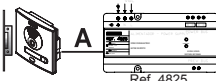
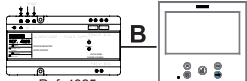
Distance section table - VIDEO KIT INSTALLATION					
SECTION CABLE	TERMINALS per home without additional power source	Maximum distance (A) Source / Filter up to Panel (Panel-Lock release) (i)	Maximum distance (B) Source/Filter up to Panel Furthest terminal		
2 x 1 mm ²	1	250	250		
	2				
	3				
2 x 0,5 mm ²	1	200	200		
	2				
	3				
2 x 0,2 mm ²	1	80	80		
	2				
	3				

- (i) For the 12Vdc lock-release and max. consumption 250mA, powered by the amplifier.

Notice: For optimal performance, we recommend using the same type of cable throughout the installation. Do not double wires.

1 LINE WIRING DIAGRAM KIT

Example: Direct current lock release connection.

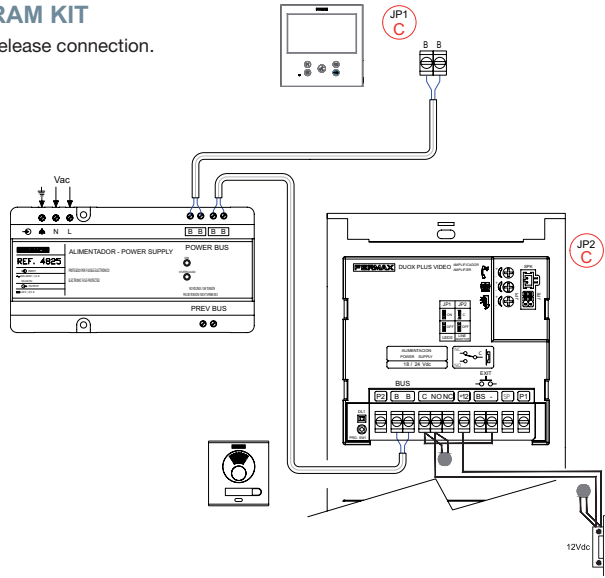

2 LINES WIRING DIAGRAM KIT

Example: Alternative current lock release connection.

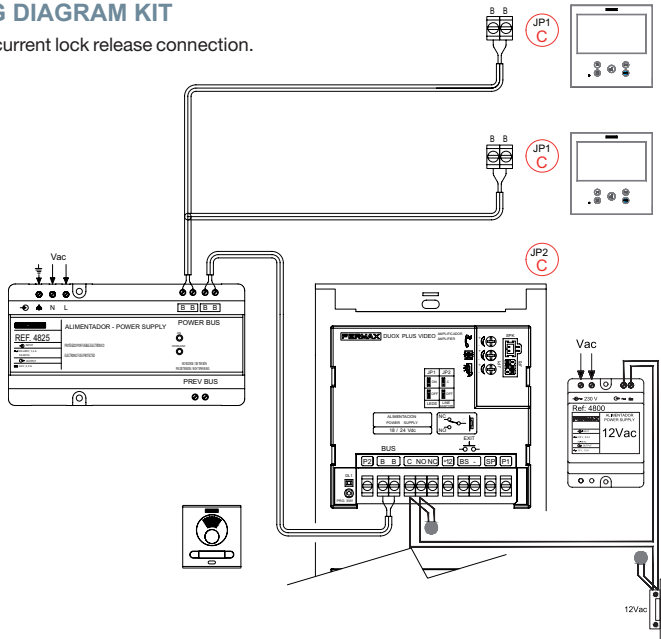

Notice: This document shows the basic concepts for a quick start-up. For more information download the manuals at www.fermax.com

- Cityline Video Duox Plus Panels cod. 970050.
- Duox Plus WIFI Veo z Monitor cod. 970164.
- Duox Plus Technical Book cod. 970122.



USER SETTINGS

1. PAIRING. Call divert.

The VEO XL WIFI DUOX PLUS monitor allows access to new Fermax services, such as call divert, through its own cloud. To use this service, the monitor must first be connected to the Internet through a pairing process.

To do this, use the Blue app, which is available on Google Play or the Apple App Store.

Monitor settings. Pairing process.

The monitor pairing process, using the Blue app, can begin once the user has registered and logged in.

The DUOX PLUS monitor is only compatible with 2.4GHz WiFi.

How to connect the monitor to the Internet.

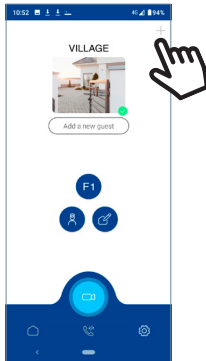
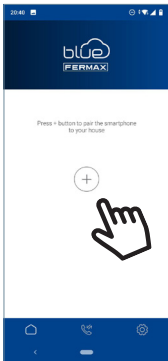

1 Open the application and log in.

2 Click on the button **+** in the middle of the default screen, or in the top right if there are already some properties listed.

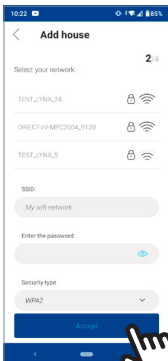

Android

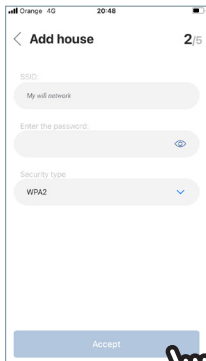

iOS

3 The user will need to select the desired WiFi network to connect the monitor.

Select (if using Android) or enter (if using iOS) the desired SSID (network name), enter the correct password to connect and click ACCEPT.

4 The user will then need to open the monitor's connectivity menu:



4a Press the MENU  button, to access the User Menu.

4b Relationship between buttons and navigation menu. The white line below the icon shows which function is currently selected.

4c Select the connectivity menu on the monitor.

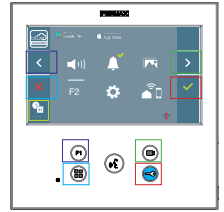
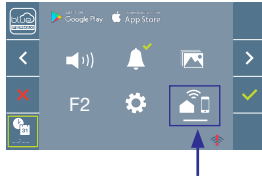
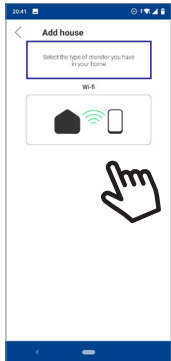

5 Once the connectivity menu is selected, press  to access.



6 A QR code will show on the monitor screen.

A MAC code is provided on screen in case the WiFi router uses MAC filtering.

7 The application will be ready to scan that code. Point your mobile phone at the QR code on the monitor screen so the code is within the green square on the mobile screen.



8 The application and monitor will begin to synchronize. The white WiFi LED on the monitor will start flashing.

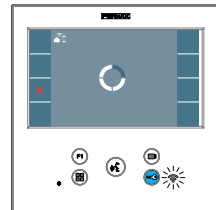
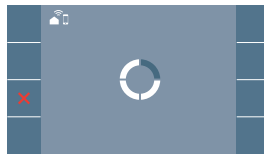

9 The screen to add a property will appear:

- Name
- Image (optional)

Enter data and press ACCEPT.

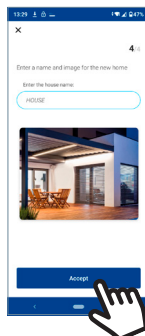

- 11 If the WiFi network and credentials provided are correct, the monitor will connect to the Internet and the process will have been completed successfully.

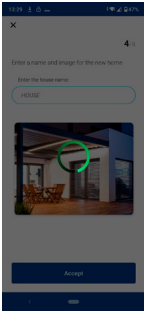

- 12 The application will show the new linked house as available and connected (green tick ✓) and the monitor will show that connection was successful. The white WiFi led will stay now stay on. 📶

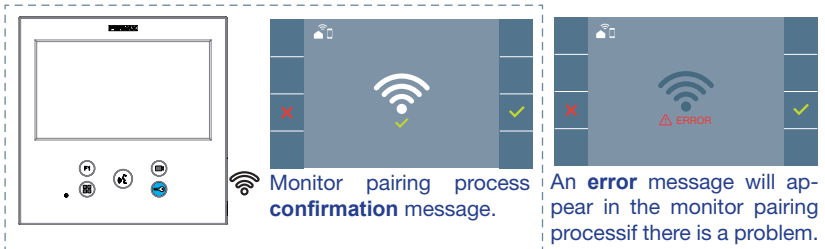
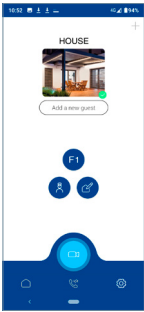

- 13 Once connected, the WiFi signal strength will appear in the bottom right of the monitor user menu.

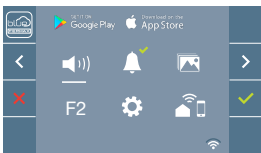

WiFi signal strength icons displayed in the menu:



Between 0% and 20% or monitor not paired.



Between 20% – 40%



Between 40% – 60%



Between 60% – 80%



Between 80% – 100%

- 14 To test the call divert function, the user can select auto-on and see whether it connects to the outdoor panel, (as long as it is not in use).

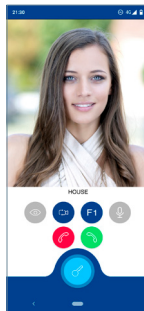
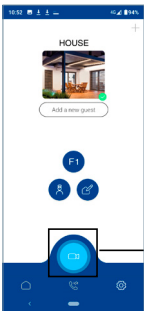

User parameter settings:

USER RESET :



A user reset returns the status of the monitor to unpaired (disconnected from the Internet).

Note: This section goes through the most basic steps in quick commissioning. For more information, please download the **DUOX PLUS Blue mobile application manual**, code: **970156** at www.fermax.com.

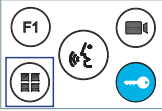
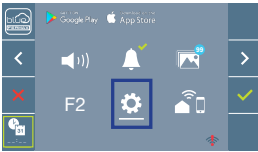
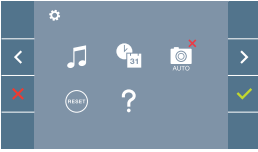
2. USER PARAMETERS: Access User Parameters.



1  2  3 



2.1 Date and Time
2.2 Capture images

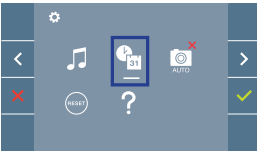

With  select the icon  and confirm with .

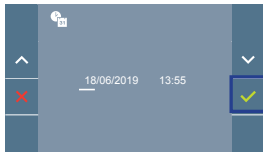



2.1 DATE AND TIME SETTINGS

The WIFI monitor automatically synchronizes the time with the time zone where it is installed whenever it is paired and connected to the Internet. In this case the date and time cannot be changed.

1  2  3 

With  select the icon  and confirm with .

With   select the date format. Once selected confirm with .

Select the date and hour with   and confirm . To browse the settings .

Date not set: 01/01/2019 (default). The icon  appears indicating that the date is not correct (default date). Upon losing power, it returns to the default date.

Note: If an image is captured with the date not yet set, the following icon appears . Notification icons for a date not set.

User Menu Screen

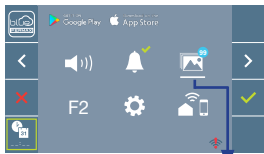
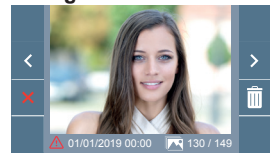

Image Viewer

Communication screen



Image viewer screen





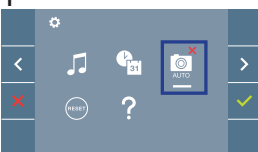
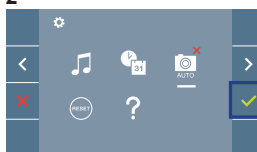
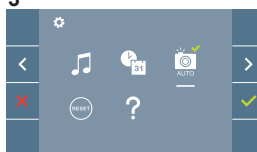

2.2 ACTIVATION / DEACTIVATION OF VIDEO CAPTURE

The monitor can take an automatic picture within 3 seconds of receiving a call from an outdoor panel. According to the European Union legislation about data protection ((EU) 2016/679), the capture of images may be restricted. This feature is deactivated by default in all monitors, although can be activated at your own responsibility.

Furthermore, the legislation may force to place a sign next to door stations, indicating that monitors can capture images. You can download it at <https://www.fermax.com/intl/en/corporate/utilities.html>.

1  2  3 

With  select the icon  and confirm with .

Press  to activate/deactivate the function.

✂ INSTALLATION

INSTALLATION DE LA PLATINE CÔTÉ RUE ET DU MONITEUR

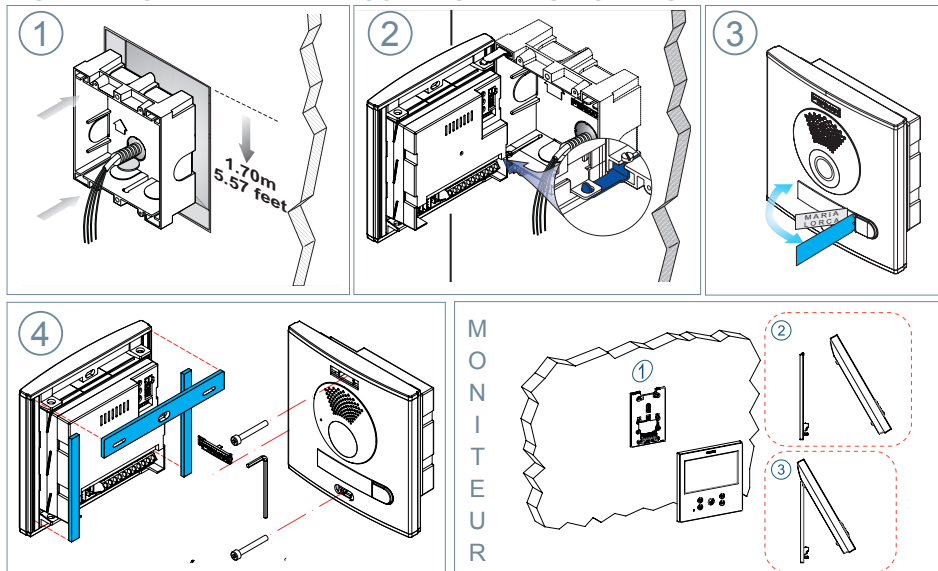

📶 CONFIGURATION





MONITEUR VEO XL WIFI DUOX PLUS

Le moniteur fourni dans le kit EST DÉJÀ PROGRAMMÉ par défaut.

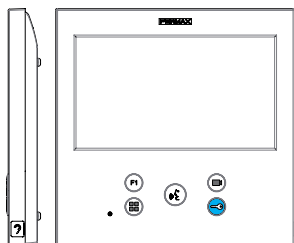
Dans le cas des kits à 2 lignes, les deux moniteurs SONT PROGRAMMÉS.

BOUTONS DE COMMANDE



-  Menu numérique pour les réglages et configuration des paramètres internes (si le moniteur est programmé).
-  Lors d'une communication, appuyez dessus pour ouvrir la porte.
En veille, appel au concierge (s'il y a une conciergerie).
-  Fonction auxiliaire (contactez votre installateur).
En veille, appuyez dessus. On a, à l'écran, la possibilité d'effectuer l'auto-insertion avec différentes platines. En appuyant de manière séquentielle sur la platine 0, platine 1, platine générale (selon la disponibilité des platines).
-  Activation du son et rattachage (fonctionnement mains libres).

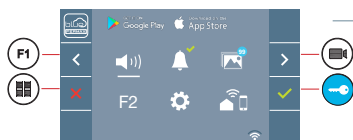

Le moniteur VEO XL WIFI intègre un menu OSD qui est géré à l'aide des boutons-poussoirs du moniteur. Les icônes qui apparaissent à l'écran se manipulent à l'aide des boutons-poussoirs correspondants du moniteur.



La ligne blanche sous l'icône indique la fonction dans laquelle nous nous trouvons.

Sélectionnez avec  /  l'icône désiré et validez à l'aide de .

RÉGLAGES

1. RÉGLAGES DU MONITEUR

RÉGLAGES VIDÉO

Si on a de l'image sur le moniteur en appuyant sur le bouton  (ou lors de la réception d'un appel sans ouvrir la communication), appuyez sur la touche  pour afficher les réglages vidéo.

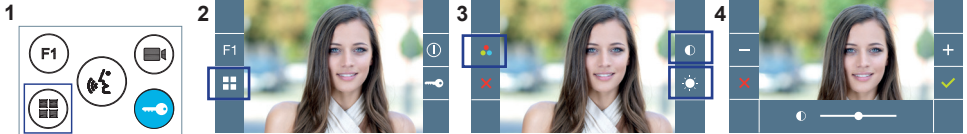

RÉGLAGES AUDIO

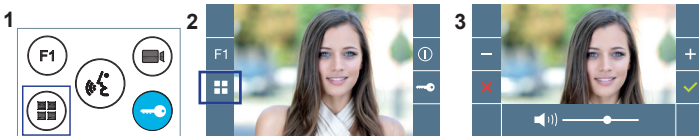

Augmentez ou diminuez à l'aide de jusqu'à obtenir le réglage souhaité.

Remarque : temps maximal de communication : 90 secondes.

2. RÉGLAGES PLATINES

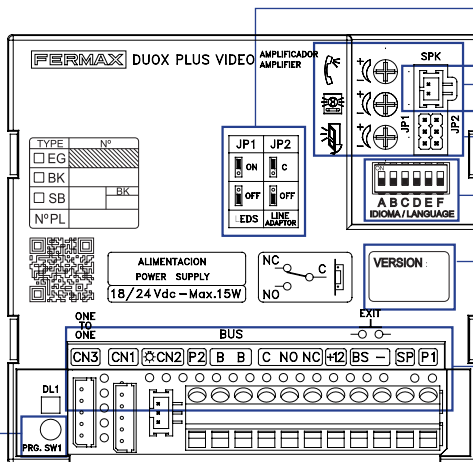

JP1 : DEL caméra

DEL ON. Activées si la caméra est activée.
DEL OFF. Toujours éteintes.

Raccordement microphone

Réglages son

du moniteur, de la platine et de la porte ouverte.

Sélection de la langue¹

du message « porte ouverte ».

Versión amplificador

Connecteurs platine :

B, B : bus DUOX PLUS: alimentation postes/moniteurs, données, audio et vidéo.

C, NO, NC : contacts relais, 2 A@30 Vcc (connexion gâche électrique).

+12 : sortie 12 Vcc-250 mA (500 mA maximum pendant 100 s).

BS, - : bouton-poussoir hall.

S, - : entrée capteur de porte.

+, GND : non disponible. Futures versions.

P1, P2 : connexion boutons-poussoirs.

Bouton SW1

¹ Sélection de la langue du message vocal émis pour « porte ouverte ».

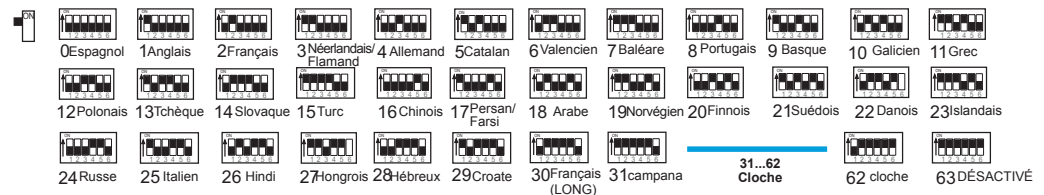

3. CODIFICATION DES PLATINES*

Il faut, dès qu'il y a plus d'une platine, programmer le numéro des platines.

4. FOCALISATION DE LA CAMÉRA / TEMPS D'ACTIVATION DE LA GÂCHE ÉLECTRIQUE*

Afin de régler l'image de la caméra ou régler le temps d'activation de la gâche électrique.

* Voir Configuration avec assistance vocale sur les platines à boutons-poussoirs code 970048. Instructions fournies avec ce matériel.



CARACTÉRISTIQUES TECHNIQUES

CARACTÉRISTIQUES TECHNIQUES PLATINE

Alimentation	18-24 Vcc
Consommation en veille	2,86 W
Consommation avec son	6,30 (max) W
Puissance du son sens logement-rue	1 W
Puissance du son sens rue-logement	0,15 W
Température de service	[-25 , +70 °C] / [-13, 158 °F]
Volume réglable dans les deux sens	

VALEURS PLATINE

Durée activation de la gâche	01...99 s. (par défaut : 03)
Durée activation bouton de sortie	00...99 s. (par défaut : 06) / (désactivé : 00)
Type de platine	sous-bâtiment/bâtiment/entrée générale. (par défaut : bâtiment)
Numéro de platine	0...9 (par défaut : 00)

Platine MASTER

CARACTÉRISTIQUES TECHNIQUES MONITEUR (écran OSD TFT 7")

Alimentation	18-24 Vdc
Consommation en veille (appairé et connecté)	1,3 W
Maximum Consommation	9,9 W
Température de service	[-5° , +40°C] / [23° , 104°F]



SCHÉMAS

TABLEAU SECTIONS - DISTANCES

Tableaux sections distances - INSTALLATION DE KITS VIDÉO

SECTION CÂBLE	TERMINAUX pour logement sans alimentations supplémentaires	 Distance maximale (A) Alimentation / filtre jusqu'à la platine (platine-gâche électrique) (1)		 Distance maximale (B) Alimentation/filtre jusqu'au terminal le plus éloigné	
		1	2	1	2
2 x 1 mm ²	1	250	250	1	250
	2			200	
	3			150	
2 x 0,5 mm ²	1	200	200	1	200
	2			120	
	3			70	
2 x 0,2 mm ²	1	80	80	1	100
	2			50	
	3			30	

- (1) Pour une gâche de 12Vdc avec une consommation max. de 250mA, alimentation depuis l'amplificateur.

Remarque : pour un fonctionnement optimal, il est recommandé d'utiliser le même type de câble pour toute l'installation.
Ne pas doubler les fils.

SCHÉMA DE CÂBLAGE KIT 1 LIGNE

Exemple: Connexion gâche à courant continu.



SCHÉMA DE CÂBLAGE KIT 2 LIGNES

Exemple: Connexion gâche à courant alternatif.

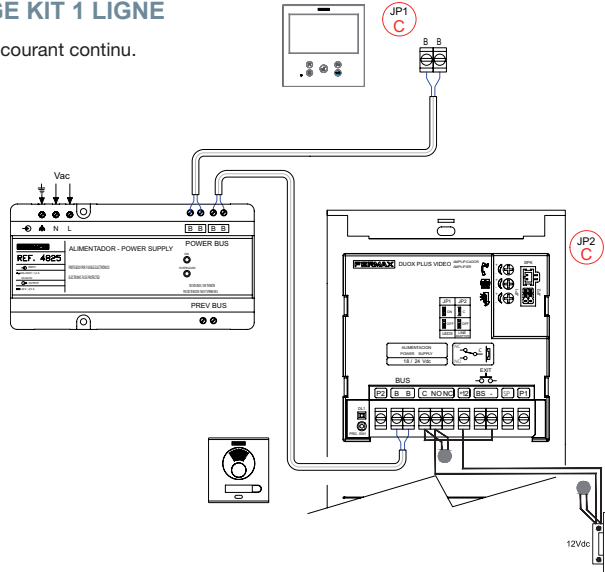
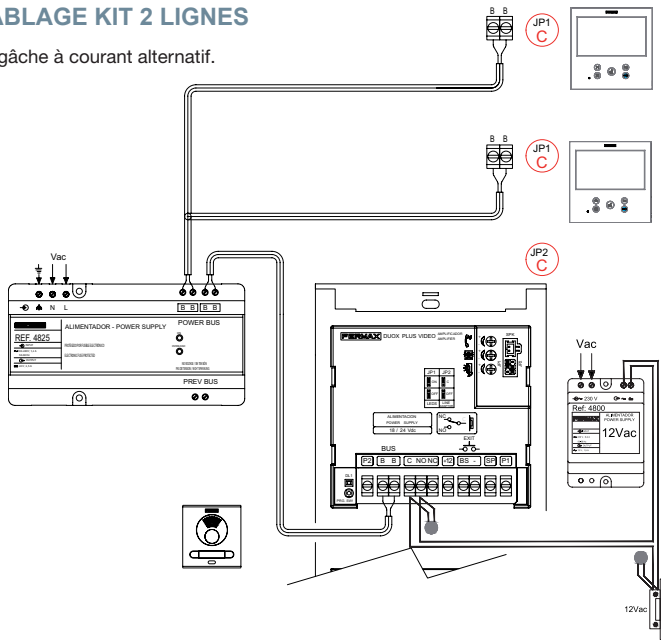

Remarque : ce document présente les concepts les plus basiques, qui permettent une mise en marche rapide. Pour plus de renseignements, téléchargez les manuels sur www.fermax.com

- Platines vidéo Cityline Duox Plus code 970050.
- Moniteur Duox Plus Veo XL WIFI code 970164.
- Manuel Technique Duox Plus 970122.



PARAMÈTRES DE L'UTILISATEUR

1. APPAIRAGE. Transfert d'appel.

Le moniteur VEO XL WIFI DUOX PLUS permet d'accéder aux nouveaux services offerts par Fermax via son propre cloud comme le transfert d'appel. Afin de pouvoir profiter de ce service, la première étape est de connecter le moniteur à internet via le processus d'appairage.

Pour ce faire, vous devez utiliser l'application Blue disponible sur Google Play ou sur l'Apple Store.

Réglages du moniteur. Processus d'appairage.

Une fois que l'utilisateur s'est enregistré et connecté à l'application Blue, nous pouvons commencer le processus d'appairage du moniteur.

Le moniteur DUOX PLUS ne prend en charge que le WIFI 2,4 GHz.

Étapes à suivre pour connecter le moniteur à Internet.

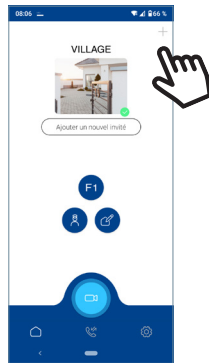

Android

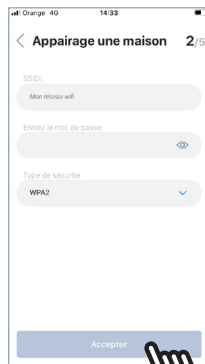

iOS

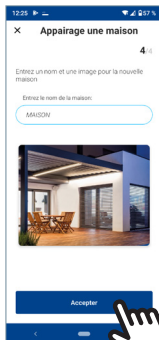
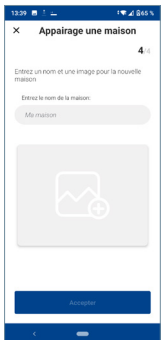
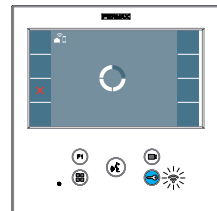
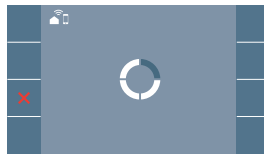
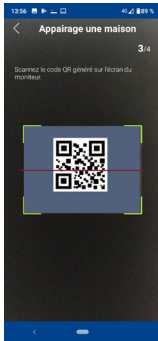
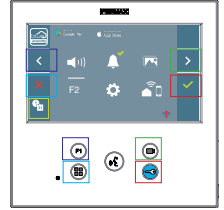
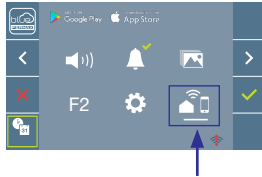

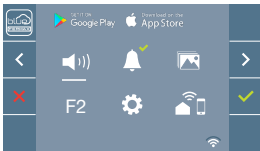
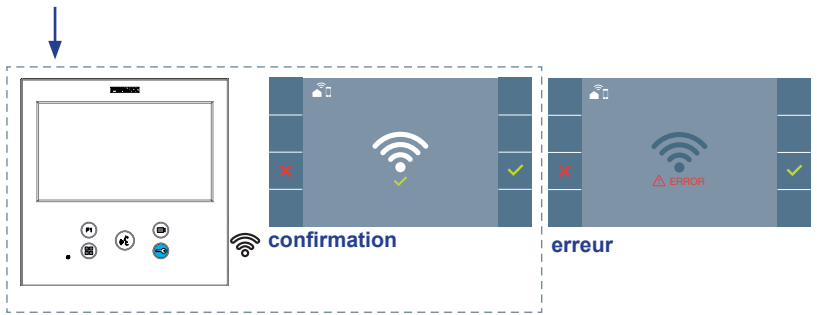
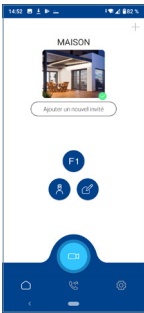
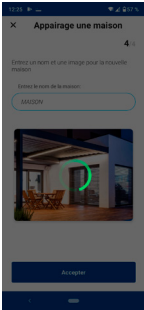

Entre 0 % et 20 %
ou moniteur non appairé.



Entre 20% y 40%



Entre 40% y 60%



Entre 60% y 80%



Entre 80% y 100%

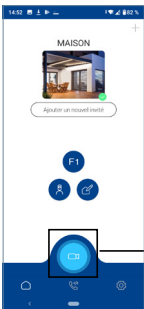

Auto-on

 Réglages des paramètres d'utilisateur:

 RÉINITIALISATION DE L'UTILISATEUR:

Une réinitialisation de l'utilisateur rétablit le statut du moniteur à non-appairé (déconnecté d'Internet).

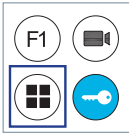
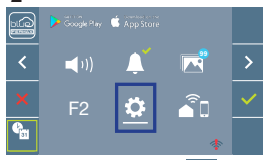
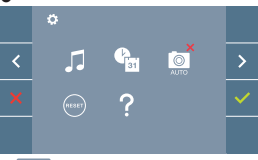

Note : Ce chapitre présente les notions de base pour une mise en service rapide, pour plus d'informations, téléchargez le manuel **Application DUOX PLUS Blue pour mobile code 970156** sur www.fermax.com.

2. PARAMÈTRES UTILISATEUR : Accéder à l'écran Paramètres d'utilisateur.

1  2  3 

2.1 Réglages Date et heure



2.2 Capture d'images



Sélectionnez avec > l'icône  et validez avec .

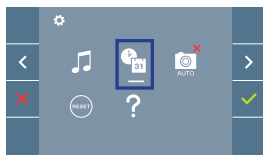
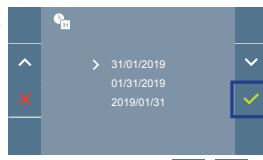
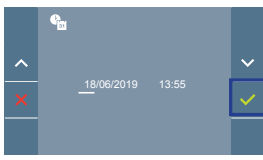

2.1 RÉGLAGES DATE ET HEURE

Lorsqu'il est appairé et connecté à Internet, le moniteur WIFI synchronise automatiquement l'heure avec le fuseau horaire qui correspond à l'endroit où il est installé. Dans ce cas, la date et l'heure ne peuvent pas être modifiées.

1  2  3 

Sélectionnez avec > l'icône  et validez avec .

Sélectionnez avec   le format de la date. Une fois sélectionné, validez avec .

Sélectionnez la date et l'heure avec   et validez avec . Pour naviguer parmi les réglages >.

Date non programmée : 01/01/2019 (par défaut). L'icône  s'affiche en indiquant que la date n'est pas correcte (date par défaut). En cas de coupure, la date revient à celle par défaut.

Remarque : si une image est capturée alors que la date n'est pas programmée, l'icône  s'affichera.

Icônes de notification de date non programmée :

Écran Menu utilisateur

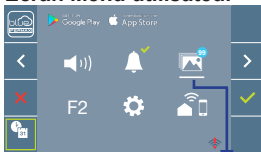

Visualisation des images

Écran Communication



Écran Visualisation des images





2.2 ACTIVATION / DÉSACTIVATION CAPTURE DES IMAGES

L'écran peut prendre une photo automatique 3 secondes après avoir reçu un appel de la platine de rue. Conformément à la loi de protection des données (EU 2016/679) de l'Union Européenne, l'utilisation de la capture d'images du vidéophone peut être restreinte. Cette fonction est désactivée par défaut. Elle peut être activée depuis le moniteur sous votre responsabilité.

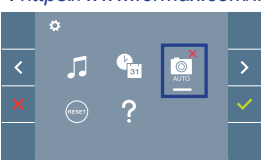
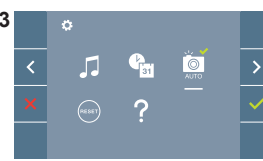
De la même façon, il peut être obligatoire de placer à côté de la platine de rue un pancarte indiquant que le moniteur peut capturer des images. Vous pouvez télécharger cette affiche sur le site suivant : <https://www.fermax.com/intl/fr/corporate/utilites.html>.

1  2  3 

Sélectionnez avec > l'icône  et validez avec .

Appuyez sur  pour activer/désactiver la fonction.

INSTALLATION

TÜRSTATION - UND MONITORINSTALLATION

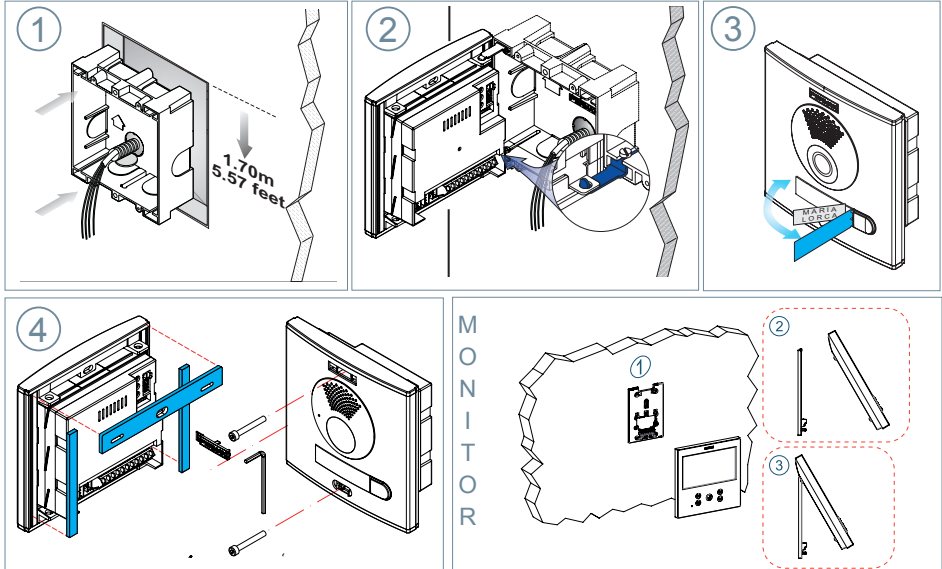





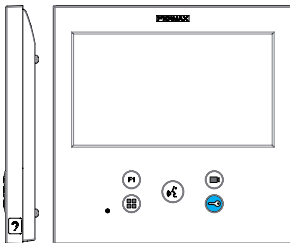

KONFIGURATION

MONITOR DUOX PLUS VEO-XL

Der im Set mitgelieferte Monitor ist **BEREITS WERKSSEITIG** programmiert.
Beim Set mit 2 Linien sind die Monitore auch **VORPROGRAMMIERT**.

BEDIENTASTEN



-  Digitales Menü zur Vornahme der Einstellung und Konfiguration der internen Parameter. (Falls der Monitor programmiert ist).
-  Im Sprechmodus drücken, um die Tür zu öffnen. Im Bereitschaftsmodus kann der Portier angerufen werden (falls eine Portierzentrale vorhanden ist).
- F1**  Zusatzfunktion (fragen Sie den Installateur).
-  Im Bereitschaftsmodus drücken, um auf dem Bildschirm die Eigenstartoption der jeweiligen Türstationen einzublenden. Dazu abwechselnd Türstation 0, Türstation 1 und Haupttürstation (gemäß Verfügbarkeit der Türstationen) drücken.
-  Aktivierung Audio- und Auflegenfunktion (Freisprechbetrieb).

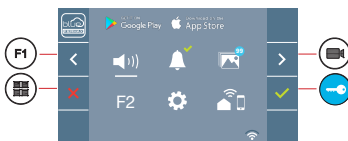

Der WIFI VEO XL Monitor enthält ein OSD-Menü, das über die Monitortasten bedient werden kann. Die auf dem Bildschirm angezeigten Symbole werden mit den entsprechenden Monitortasten bedient.

Die weiße Linie unter dem Symbol zeigt die aktuelle Funktion an.

Mittels das Symbol  /  wählen gewünschte icon und mit  bestätigen.

EINSTELLUNGEN

1. MONITOREINSTELLUNGEN

VIDEOEINSTELLUNGEN

Wenn ein Bild auf dem Monitor eingeblendet wird (oder bei einem eingehenden Anruf ohne die Kommunikation zu starten) zuerst die Taste und anschließend die Taste drücken, um die Videoeinstellungen einzublenden.

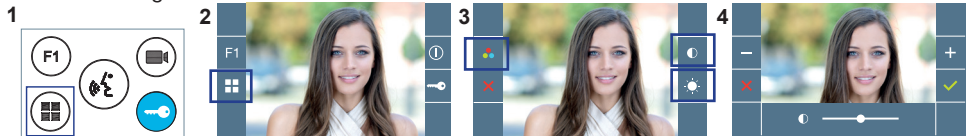

Die gewünschte Option auswählen und die Einstellungen mit den Tasten und erhöhen oder verringern.

AUDIOEINSTELLUNGEN

Während der Audiokanal geöffnet ist, die Taste drücken, um die Menüfunktionen dieser Einstellung aufzurufen.

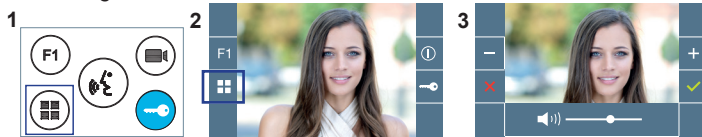

Mithilfe der Tasten und können die Einstellungen entsprechend angepasst werden.

Hinweis: Maximale Gesprächsdauer: 90 Sekunden.

2. TÜRSTATIONEINSTELLUNGEN

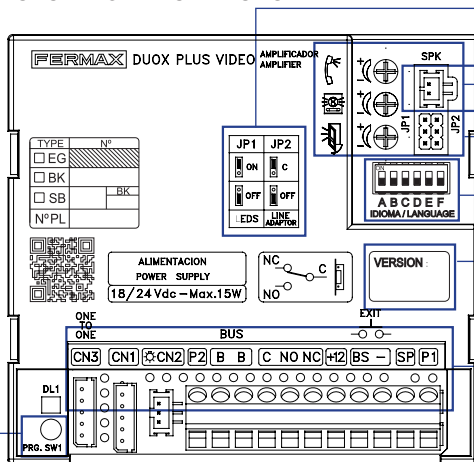

JP1: Kamera-LEDs

LEDS EIN, leuchten, wenn die Kamera aktiviert ist.
LEDS AUS, immer ausgeschaltet.

Mikrofonanschluss

Audioeinstellungen
des Monitors, der Türstation und Meldung Tür. öffnen.

Sprachwahl ¹

der Meldung „Tür offen“.

Verstärkerversion

Anschlüsse Türstation:

- B, B:** DUOX PLUS-Bus: Stromversorgung Telefone/Monitore, Daten, Audio und Video.
- C, NO, NC:** Relais-Kontakte, 2A@30VDC (Anschluss Türöffner).
- +12:** Ausgang (12 VDC/250 mA) (max. 500mA während 100 Sek.).
- BS, -:** Türöffnungstaste Flur.
- S, -:** Türsensor Eingang.
- +, GND:** nicht verfügbar. Zukünftige Versionen.
- P1, P2:** Tastenanschluss.

SW1-Taste

¹ Sprachwahl der Meldung „Tür offen“

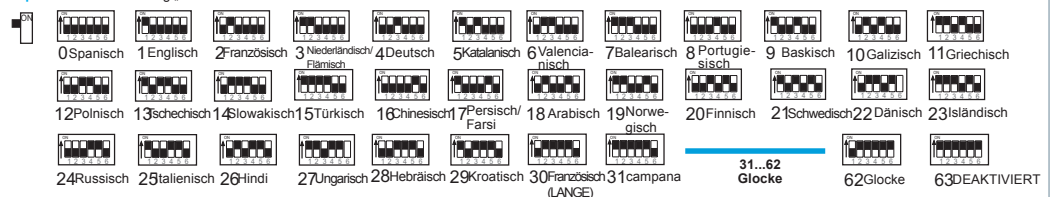

3. TÜRSTATIONEN KONFIGURIEREN*

Falls mehr als eine Türstation vorhanden ist, müssen die Türstationen programmiert werden, damit sie Nummern aufweisen.

4. KAMERAFOKUS / AKTIVIERUNGSZEIT DES TÜRÖFFNERS*

Um das Kamerabild oder die Aktivierungszeit des Türöffners einzustellen.

* Siehe sprachgeführte Konfiguration bei Türstationen mit Tastenmodulen, Kode 970048. Die Anleitung ist in der Geräteverpackung enthalten.



TECHNISCHE EIGENSCHAFTEN

TECHNISCHE EIGENSCHAFTEN TÜRSTATION

Stromversorgung	18 -24 Vdc
Stromverbrauch im Bereitschaftsmodus	2,86 W
Stromverbrauch im Sprechmodus	6,30 (max) W
Audibleistung Wohnung ->Türstation	1 W
Audibleistung Türstation > Wohnung	0,15 W
Betriebstemperatur	[- 25 °C , + 70 °C] / [- 13 °F, 158 °F]
Regulierbare Lautstärke in beiden Richtungen	

WERTE TÜRSTATION

Aktivierungszeit Türöffner	01...99 Sek. (standardmäßig: 03)
Aktivierungszeit Türöffnungstaste:	00...99 Sek. (standardmäßig: 06) / (deaktiviert: 00)
Türstationstyp	Nebenblock/Block/Haupteingang. (standardmäßig: Block)
Türstationnummer	0...9 (standardmäßig: 00)

MASTER-Türstation

TECHNISCHE EIGENSCHAFTEN MONITOR (7" Flachbildschirm mit Bildschirmanzeige OSD)

Stromversorgung	18 - 24 Vdc
Stromverbrauch im Bereitschaftsmodus (gekoppelt und verbunden)	1,3 W
Stromverbrauch maximal	9,9 W
Betriebstemperatur	[-5° , +40°C] / [23° , 104°F]



SCHEMATA

QUERSCHNITT-UNDABSTANDSTABELLE

Querschnitt- und Abstandstabellen - INSTALLATION VON VIDEO-SETS

KABEL QUERSCHNITT	SPRECH-STELLEN pro Wohnung ohne zusätzliche Netzgeräte	Maximaldistanz (A) Netzgerät/ Filter bis Türstation (Türstation-Türöffner) (i)		Maximaldistanz (B) Netzgerät/ Filter bis zur am weitesten entfernte Sprechstelle	
		A	B	A	B
2 x 1 mm ²	1	250	250	250	200
	2				
	3				
2 x 0,5 mm ²	1	200	200	120	70
	2				
	3				
2 x 0,2 mm ²	1	80	80	100	50
	2				
	3				

(i) Für 12-VDC-Türöffner und maximalem Stromverbrauch von 250 mA, mit Stromversorgung über den Verstärker.

Hinweis: Für einen optimalen Betrieb empfehlen wir denselben Kabeltyp für die gesamte Anlage zu verwenden. Drähte nicht verdoppeln.

VERKABELUNGSSCHEMA 1-LINIEN-SET

Beispiel: Anschluss Türöffner mit Gleichstrom

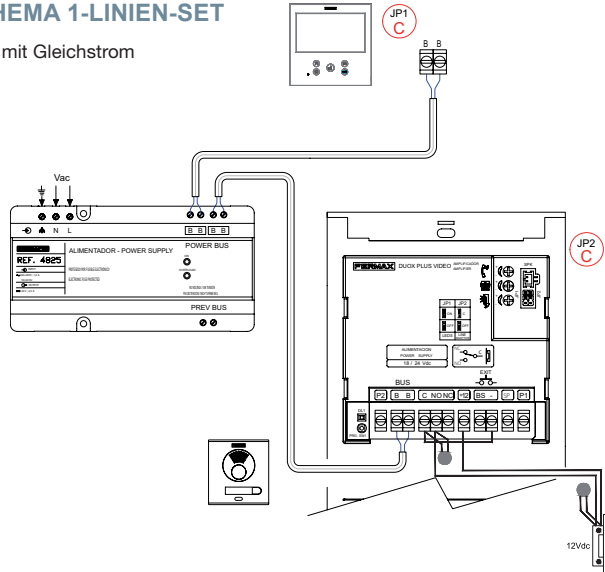

VERKABELUNGSSCHEMA, 2-LINIEN-SET

Beispiel: Anschluss Türöffner mit Wechselstrom.

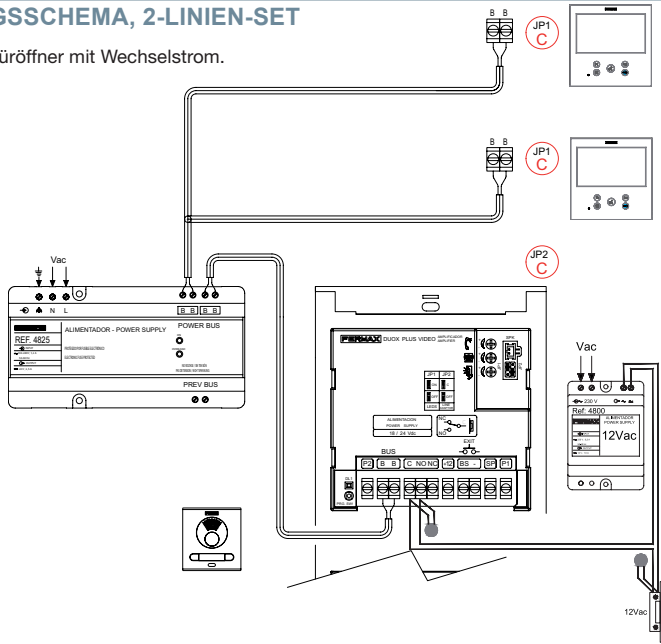

Hinweis: Dieses Dokument veranschaulicht die grundlegenden Konzepte für eine schnelle Inbetriebnahme der Anlage. Weitere Information können Sie den Handbüchern auf www.fermax.com entnehmen.

- Türstationen Cityline Video Duox Plus, Kode 970050.
- Duox Plus WIFI Veo Monitor, Kode 970164.
- Duox Plus Technisches Handbuch, Kode 970122.



BENUTZER-EINSTELLUNGEN

1. PAIRING. Rufweiterleitung.

Der VEO XL WIFI DUOX PLUS Monitor ermöglicht über eine eigenen Cloud den Zugriff auf neue von Fermax angebotene Services, wie z.B. die Rufweiterleitung. Um diesen Service in Anspruch nehmen zu können ist der erste Schritt, den Monitor über den sogenannten Pairing-Prozess mit dem Internet zu verbinden.

Hierzu ist es erforderlich, die Blue App zu verwenden, die im Google Play oder Apple Store verfügbar ist.

Monitor-Einstellungen. Pairing-Prozess.

Mit Hilfe der Blue-App und nachdem sich der Benutzer registriert und eingeloggt hat, können wir mit dem Pairing des Monitors beginnen.

Der DUOX PLUS-Monitor ist nur mit WIFI 2,4GHz kompatibel.

Vorgehensweise zur Verbindung des Monitors mit dem Internet.

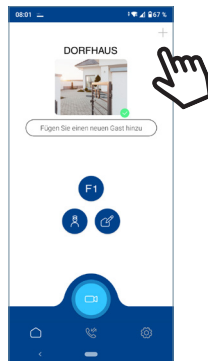

1 Starten Sie die Anwendung und melden Sie sich an.

2 Klicken Sie auf die Schaltfläche + in der Mitte des Standardbildschirms oder oben rechts, wenn bereits einige Wohnungen verfügbar waren.

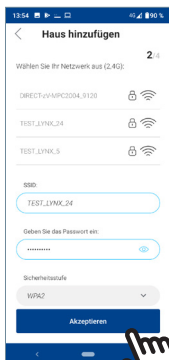

Android

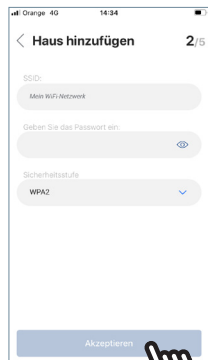

iOS

3 Die Anwendung erfordert, dass der Benutzer das gewünschte WLAN-Netzwerk für den Anschluss des Monitors auswählt.

Wählen Sie (bei Android) oder geben Sie (bei iOS) die gewünschte SSID (Netzwerkname) ein, geben Sie das richtige Passwort für die Verbindung ein und klicken Sie auf AKZEPTIEREN.

4 Die Anwendung erfordert, dass der Benutzer das Konfigurationsmenü für die Verbindung auf dem Monitor aufruft: 

4a Durch Drücken der MENU-Taste  gelangen Sie zum Benutzermenü-Bildschirm.

4b Zuordnung zwischen Drucktasten und Navigationsmenü. Die weiße Linie unter dem Symbol zeigt die Funktion an, in der wir uns befinden.

4c Wählen Sie das Einstellungsmenü für die Verbindung auf dem Monitor aus.

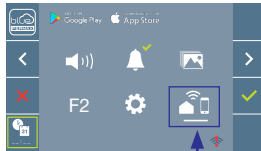
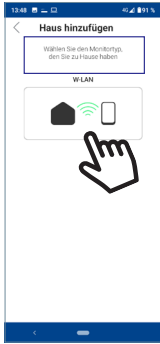

5 Sobald das Verbindungsmenü ausgewählt ist, bestätigen Sie mit , um es zu öffnen.

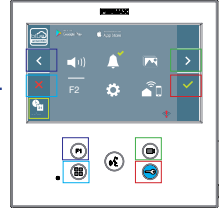

6 Der Monitor zeigt einen QR-Code auf dem Bildschirm an.

Die MAC wird auf dem Bildschirm angezeigt, falls der WLAN-Router über einen MAC-Filter verfügt.

7 Die Anwendung ist bereit, diesen Code zu scannen. Erfassen Sie mit dem Mobiltelefon den QR-Code auf dem Bildschirm, wobei das Mobiltelefon mit dem grünen Quadrat auf dem Bildschirm des Mobiltelefons ausgerichtet ist.

8 Die Applikation und der Monitor beginnen sich miteinander zu synchronisieren. Die weiße WLAN-LED am Monitor beginnt zu blinken.

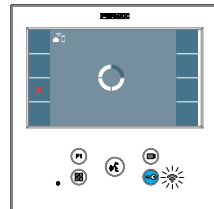
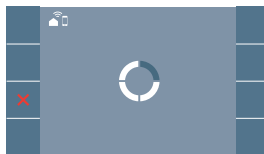
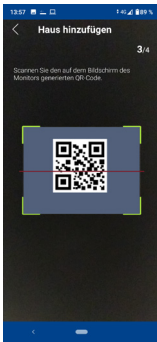

9 Der Bildschirm zum Hinzufügen der Wohnung wird angezeigt:

- Name
- Bild (optional)

Geben Sie die Daten ein und drücken Sie **AKZEPTIEREN**.



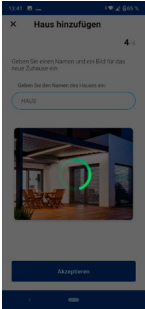

- 11 Wenn das WLAN-Netzwerk und die angegebenen Zugangsdaten korrekt sind, verbindet sich der Monitor mit dem Internet und der Prozess wird erfolgreich abgeschlossen.



- 12 Die Anwendung zeigt die neue verbundene Wohnung als verfügbar und verbunden an (grünes Häkchen ✓) und der Monitor zeigt das Ergebnis der Verbindung als erfolgreich an. Die weiße WLAN-LED leuchtet nun weiter.



Bestätigungsmeldung des Monitor-Pairing-Prozesses.

Wenn es nicht korrekt ausgeführt wird, erscheint eine **Fehlermeldung** des Monitor-Pairing-Prozesses.

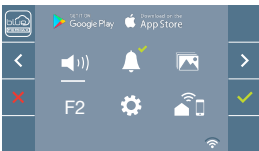

- 13 Sobald die Verbindung hergestellt ist, wird bei erneutem Aufrufen des Benutzermenüs unten rechts auf dem Monitor die Stärke des WLAN-Signals angezeigt.

Intensitätsstufen des im Menü angezeigten WLAN-Signalsymbols:



Zwischen 0% und 20% oder nicht gekoppelter Monitor.



Zwischen 20% und 40%



Zwischen 40% und 60%.



Zwischen 60% und 80%



Zwischen 80% und 100%.



Auto-on

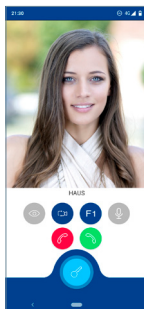

- 14 Um die Rufweiterleitung zu testen, kann der Benutzer eine automatische Einschaltung durchführen und nachvollziehen, dass er sich mit der Türstation im Außenbereich verbindet (sofern sie nicht in Gebrauch ist).

Benutzereinstellungen:

BENUTZER-RESET:
Ein Benutzer Reset setzt den Status des Monitors auf nicht gekoppelt (vom Internet getrennt) zurück.

Hinweis: In diesem Kapitel werden die wichtigsten Grundlagen für eine schnelle Inbetriebnahme beschrieben. Weitere Informationen finden Sie im DUOX PLUS Blue Application Handbuch für mobile Anwendungen. Code **970156** unter www.fermax.com.

2. PARAMETEREINSTELLUNGEN DES BENUTZERS: Aufrufen des Menüs Benutzerparameter.



2.1 DATUM - UND UHRZEITEINSTELLUNGEN

Der WIFI-Monitor synchronisiert die Zeit automatisch mit der Zeitzone, in der er installiert ist, wenn er gekoppelt und mit dem Internet verbunden ist. In diesem Fall können Datum und Uhrzeit nicht geändert werden.

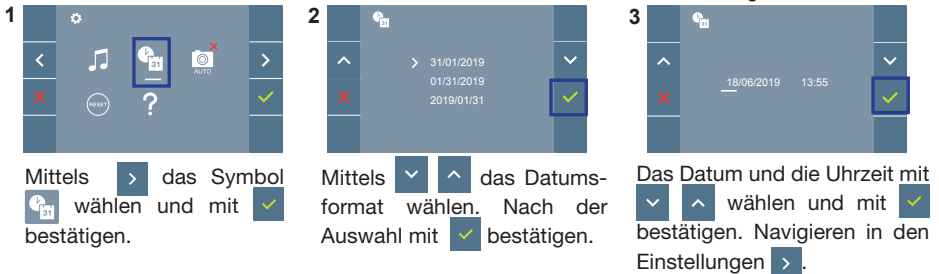

Daten ohne Programmierung: 01/01/2019 (standardmäßig). Das Symbol wird eingeblendet und zeigt an, dass das Datum nicht richtig ist (standardmäßiges Datum). Bei Unterbruch der Stromversorgung wird das standardmäßige Datum wiederhergestellt.

Hinweis: Falls ein Bild aufgenommen wird, ohne dass ein Datum einprogrammiert ist, wird das Symbol angezeigt.

Symbole bei Datum ohne Programmierung:

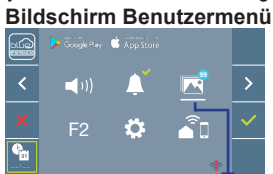

Visualisierung der Bilder

2.2 AKTIVIERUNG / DEAKTIVIERUNG DER BILDAUFNAHME

Der Monitor kann 3 Sekunden nach Anrufeingang von einer Türstation automatisch ein Bild aufnehmen. Aufgrund der Datenschutzverordnung (EU 2016/679) der Europäischen Union kann die Aufnahme von Bildern eingeschränkt werden. Im Auslieferungszustand ist diese Funktion deaktiviert, kann aber auf eigene Verantwortung aktiviert werden.

Ebenfalls könnte diese Verordnung zwingend vorschreiben, dass ein Warnschild neben der Türstation zu platzieren ist, welches auf die Bildspeicherfunktion des Monitors hinweist. Ein solches Musterschild können Sie sich von <https://www.fermax.com/intl/de/pro/online-support.html> downloaden.

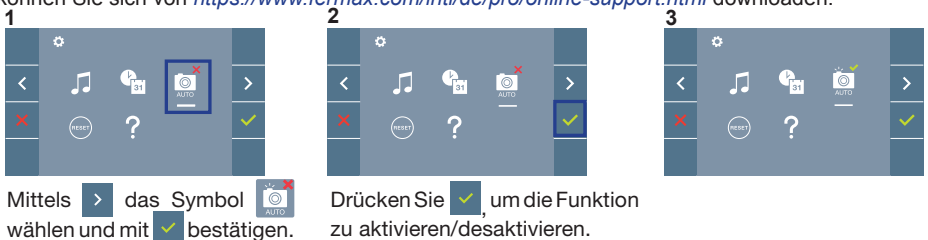

✂ INSTALAÇÃO

INSTALAÇÃO DA BOTONEIRA NA RUA E DO MONITOR

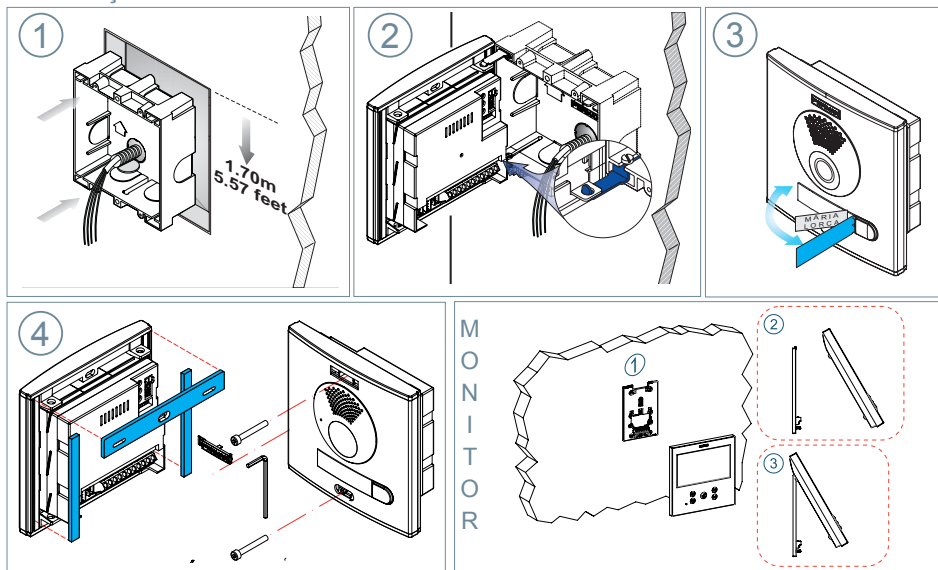

🏠 CONFIGURAÇÃO





MONITOR VEO XL WIFI DUOX PLUS

O monitor fornecido no kit **JÁ VEM PROGRAMADO** de fábrica.

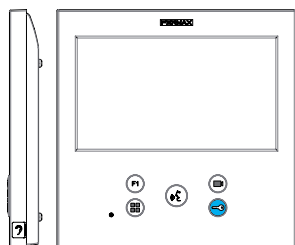
No caso do kit de 2 linhas, ambos os monitores já **VÊM PROGRAMADOS**.

BOTÕES DE CONTROLO



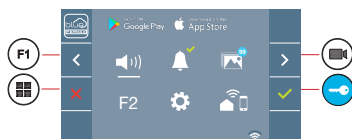

-  Menu digital para ajustes e configuração de parâmetros internos (se o monitor está programado).
-  Em conversação, premir para abrir a porta.
Em repouso, chamada ao porteiro (se existir portaria).
-  **F1** Função auxiliar (consulte o seu instalador).
Em repouso, ao premir, visualiza-se no ecrã a possibilidade de efetuar a ligação automática com diferentes botoneiras. Premindo sequencialmente Botoneira 0, Botoneira 1, Botoneira Geral (conforme a disponibilidade de botoneiras).
-  Ativação de áudio e desligar (funcionamento mãos livres).



O monitor VEO XL WIFI integra um menu OSD que é gerido através dos botões do monitor. Os ícones visualizados no ecrã são comandados por meio dos botões correspondentes localizados no monitor.

A linha branca debaixo do ícone indica a função em que nos encontramos.

Selecionar com  /  o ícone desejado e confirmar com .



AJUSTES

1. AJUSTES DO MONITOR

AJUSTES DE VÍDEO

Tendo imagem no monitor ao premir o botão , (ou ao receber uma chamada sem iniciar a comunicação) pressionar a tecla  para mostrar os ajustes de vídeo.

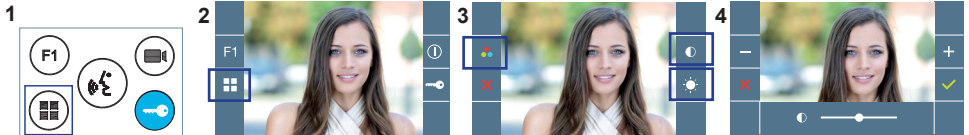



Selecionar a opção do ajuste e ir aumentando ou diminuindo com  e .

AJUSTES DE ÁUDIO

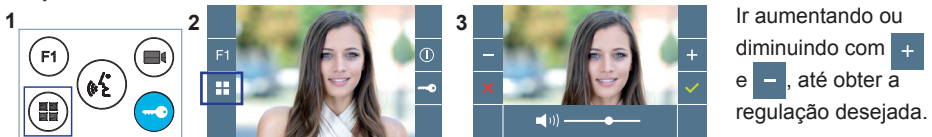
Enquanto o canal de áudio estiver aberto, premindo o botão , aparecerá no ecrã o menu para tal ajuste.



Ir aumentando ou diminuindo com  e , até obter a regulação desejada.

Nota: Tempo máximo de conversação: 90 segundos.

2. AJUSTES DAS BOTONEIRAS

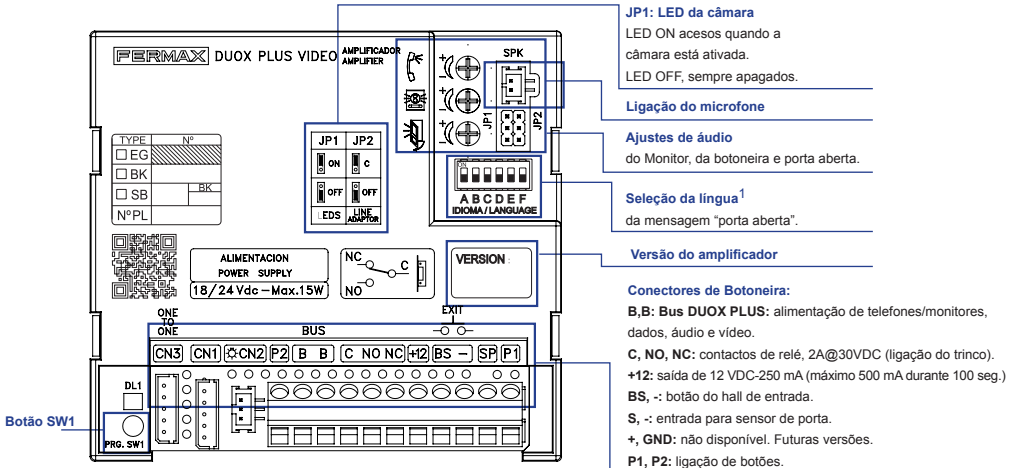

¹ Seleção da língua da mensagem "Porta aberta"

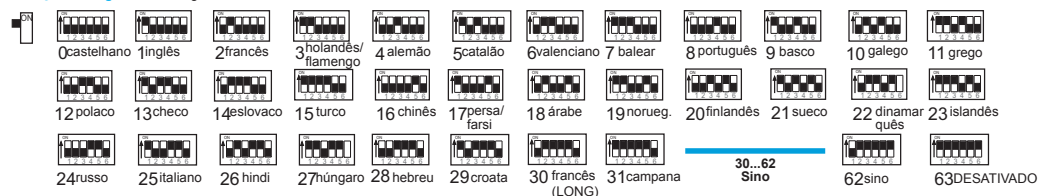

3. CODIFICAR BOTONEIRAS*

Sempre que exista mais que uma botoneira, será necessário programar o número de botoneiras.

4. FOCAGEM DA CÂMARA / TEMPO DE ATIVAÇÃO DO TRINCO*

Para ajustar a imagem da câmara ou regular o tempo de ativação do trinco.

* Ver Configuração assistida por voz em placas de interruptores cód. 970048. Instrução incluída neste equipamento.



CARACTERÍSTICAS TÉCNICAS

CARACTERÍSTICAS TÉCNICAS DA BOTONEIRA

Alimentação	18-24 Vdc
Consumo em repouso	2,86 W
Consumo de áudio ativo	6,30 (max) W
Potência de áudio no sentido habitação-rua	1 W
Potência de áudio no sentido rua-habitação	0,15 W
Temperatura de funcionamento	[-25° , +70°C] / [-13° , 158°F]
Volume regulável em ambos os sentidos	

VALORES DA BOTONEIRA

Tempo de ativação do trinco	01...99 seg. (por predefinição: 03)
Tempo de ativação do botão de saída	00...99 seg. (por predefinição: 06) / (desativado: 00)
Tipo de botoneira	subbloco/bloco/entrada geral. (por predefinição: bloco)
Número de botoneira	0...9 (por predefinição: 00)
Botoneira MASTER	

CARACTERÍSTICAS TÉCNICAS DO MONITOR (Ecrã OSD TFT 7")

Alimentação	18-24 Vdc
Consumo em repouso (emparelhado e conectado)	1,3 W
Consumo maximo	9,9 W
Temperatura de funcionamento	[-5° , +40°C] / [23° , 104°F]



ESQUEMAS

TABELA DE SECÇÕES - DISTÂNCIAS

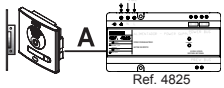
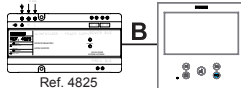
Tabelas de secções e distâncias - INSTALAÇÃO DE KITS DE VÍDEO			
SECÇÃO CABO	 TERMINAIS por habitação sem fontes adicionais	 Distância máxima (A) Fonte/Filtro até à Botoneira (Botoneira-Trinco) (i)	 Distância máxima (B) Fonte/Filtro até ao Terminal mais afastado
2 x 1 mm ²	1	250	250
	2		200
	3		150
2 x 0,5 mm ²	1	200	200
	2		120
	3		70
2 x 0,2 mm ²	1	80	100
	2		50
	3		30

- (i) Para trincos de 12 VDC e consumo máx. de 250 mA, alimentador a partir do amplificador.

Nota: Para um funcionamento ideal, recomenda-se a utilização do mesmo tipo de cabo em toda a instalação. Não duplicar fios.

ESQUEMA DE CABLAGEM DO KIT DE 1 LINHA

Exemplo: Conexão trinco de corrente contínua.

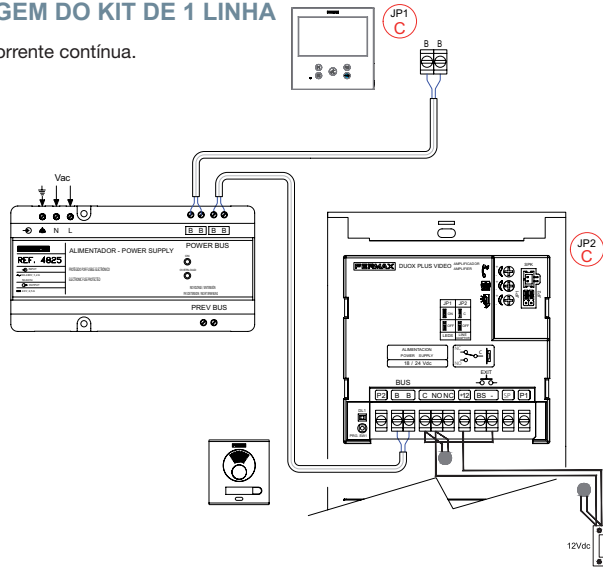

ESQUEMA DE CABLAGEM DO KIT DE 2 LINHAS

Exemplo: Conexão trinco de corrente alternada.

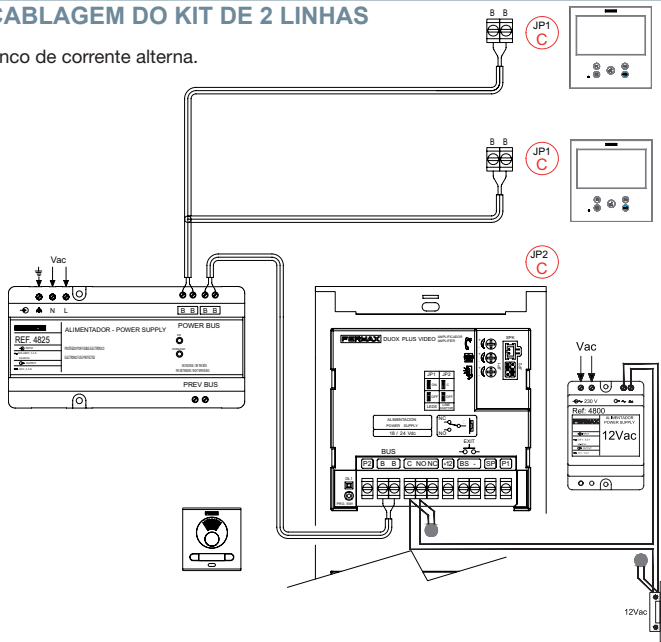

Nota: Este documento apresenta os conceitos mais básicos para a rápida colocação em funcionamento; para mais informação, fazer o download dos manuais em www.fermax.com

- Botoneiras Cityline Vídeo Duox Plus cód. 970050.
- Monitor Duox Plus Veo XL WIFI cód. 970164.
- Livro Técnico Duox Plus cód. 970122.

AJUSTES DE USUÁRIO

1. EMPARELHAMENTO. Desvio da chamada.

O monitor VEO XL WIFI DUOX PLUS permite o acesso a novos serviços oferecidos pela Fermax através da sua própria nuvem, como o desvio da chamada. Para usufruir deste serviço o primeiro passo é conectar o monitor à Internet através do processo chamado de emparelhamento.

Para fazer isto, precisa de usar a aplicação Blue disponível na aplicação Google Play ou Apple Store.

Ajustes do monitor. Processo de emparelhamento.

Com a ajuda da aplicação Blue e após o registo e início de sessão do usuário podemos iniciar o processo de emparelhamento do monitor.

O monitor DUOX PLUS só é compatível com WIFI 2.4GHZ.

Passos para conectar o monitor à Internet.

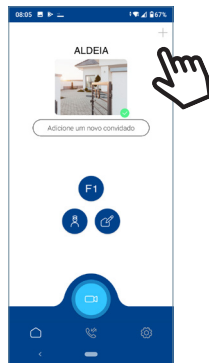

Android

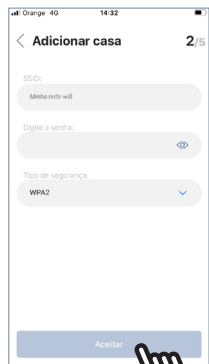

iOS

- 1 Abra a aplicação e inicie sessão.
- 2 Clique no botão  no centro do ecrã predefinido ou no canto superior direito se já existirem algumas vivendas disponíveis.
- 3 A aplicação exigirá que o usuário selecione a rede WIFI desejada para conectar o monitor. Selecione (no caso do Android) ou insira (no caso do iOS) o SSID desejado (nome da rede), digite a senha correta para conectar e clique em ACEITAR.

- 4 A aplicação exigirá que o utilizador abra o menu de conectividade no monitor



- 4a Pressionar o botão MENU  para aceder ao ecrã Menu do Utilizador.

- 4b** Correspondência entre os botões e o menu de navegação. A linha branca abaixo do ícone indica a função em que estamos.
- 4c** Selecciono o menu de conectividade no monitor.

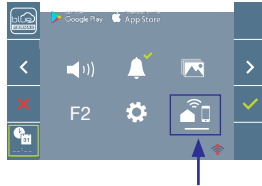
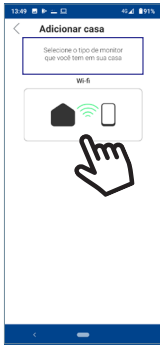
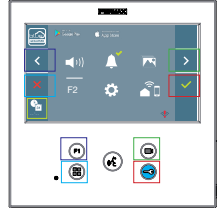

- 5** Uma vez seleccionado o menu de conectividade, confirme com  para aceder no mesmo.



- 6** O monitor exibirá um código QR no ecrã.
O MAC é fornecido no ecrã se o router wifi tiver filtro MAC.

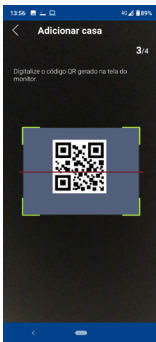

- 7** A aplicação estará pronta para digitalizar esse código. Aponte o QR no ecrã do monitor com o telemóvel alinhado com o quadrado verde no ecrã do telemóvel.

- 8** A aplicação e o monitor começarão o processo de sincronização. O LED WIFI branco no monitor começará a piscar.

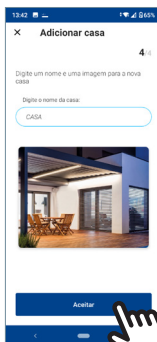
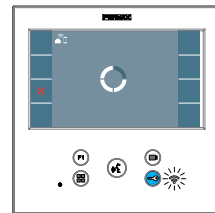
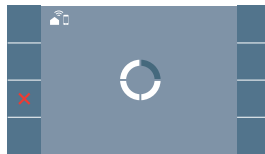

- 9** Visualiza-se o ecrã para adicionar a vivenda:

- Nome
- Imagem (opcional)

Insira os dados e pressione ACEITAR.

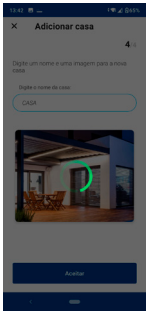

- 11 Se a rede WIFI e as credenciais fornecidas estiverem corretas, o monitor conecta-se à Internet e o processo será concluído com sucesso.



- 12 A aplicação mostrará a nova vivenda vinculada como disponível e conectada (✓ tick verde) e o monitor mostrará o resultado da conexão como bem sucedido. Agora o LED WIFI branco permanece aceso. 📶



📶 Mensagem de **confirmação** no processo de emparelhamento do monitor.

Se não for executado corretamente, mensagem de **erro** no processo de emparelhamento do monitor.

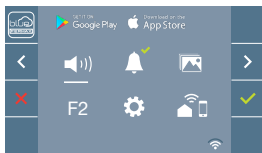

- 13 Uma vez conectado, se o menu do usuário for aberto novamente no monitor, mostrará a intensidade do sinal WIFI no canto inferior direito.

Níveis de intensidade do ícone de sinal wifi apresentado no menu:



Entre 0% e 20%
ou monitor não emparelhado.



Entre
20% e 40%



Entre
40% e 60%



Entre
60% e 80%



Entre
80% e 100%



Auto-on

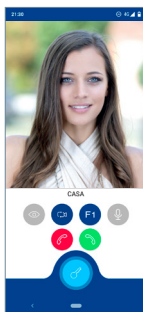

- 14 Para testar o reencaminhamento de chamadas, o usuário pode executar um início automático e verificar se se conecta à botoneira de rua (sempre e quando não estiver a ser usada).



Ajustes parâmetros de usuário:





RESET DE USUÁRIO:

Uma reinicialização (reset) do usuário retorna o status do monitor para não emparelhado (desligado da Internet).

Nota: Este capítulo apresenta os conceitos mais básicos para uma colocação em funcionamento rápida, para mais informações descarregue o manual **Aplicação DUOX PLUS Blue para código móvel. 970156** em www.fermax.com.

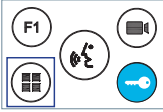
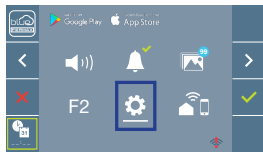
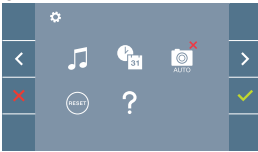
2. PARÂMETROS DO UTILIZADOR: Aceder ao ecrã Parâmetros do usuário.

1  2  3 

Com, > selecionar o ícone  e confirmar com .



2.1 Ajustes da data e hora



2.2 Captura de imagens

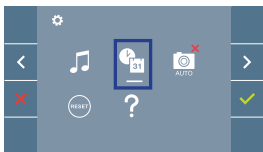
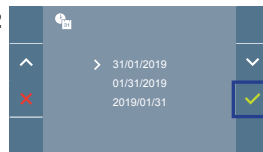
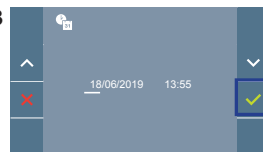

2.1 AJUSTES DA DATA E HORA

O monitor WIFI sincroniza automaticamente a hora com o fuso horário onde está instalado sempre que estiver emparelhado e ligado à Internet. Neste caso, a data e a hora não podem ser alteradas.

1  2  3 

Com >, selecionar o ícone  e confirmar com .

Selecionar o formato da data com  . Depois de selecionada, confirmar com .

Selecionar a data e a hora com   e confirmar com . Para navegar pelos ajustes, >.

Data por programar: 01/01/2019 (por predefinição). Aparecerá o ícone , indicando que a data não está correta (data por predefinição). Em caso de corte de alimentação, é reposta a data por predefinição.

Nota: Quando se captura uma imagem com a data por programar, aparece o ícone .

Ícones de notificação de data por programar:

Ecrã Menu do utilizador

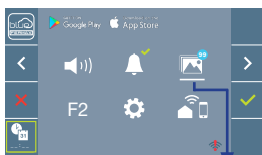

Visualização de imagens

Ecrã Comunicação



Ecrã Visualização de imagens

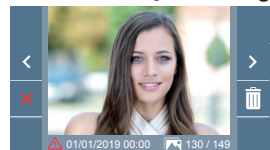



2.2 ATIVAÇÃO / DESATIVAÇÃO DA CAPTURA DE IMAGENS

O monitor realizará uma fotografia automática passados 3 segundos de ter recebido uma chamada de uma botoneira de rua. Devido à legislação de proteção de dados ((UE) 2016/679) da União Europeia, a captura de imagens pode ser restrita. Por defeito está desativada, podendo ser ativada no monitor por sua conta e risco.

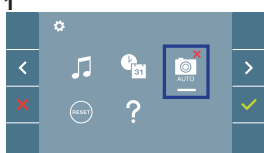
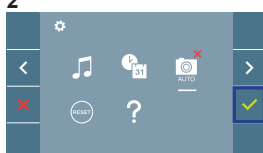
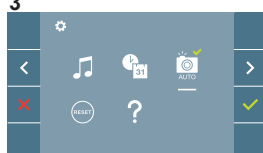
Também obriga a colocar ao lado da placa de rua um aviso indicando que o monitor pode capturar imagens. Pode ser descarregado em <https://www.fermax.com/portugal/corporate/utilidades.html>.

1  2  3 

Selecionar com >, o ícone  e confirmar com .

Premir  para ativar/desativar a função.

INSTALACJA

INSTALACJA PANELU ZEWNĘTRZNEGO I MONITORA

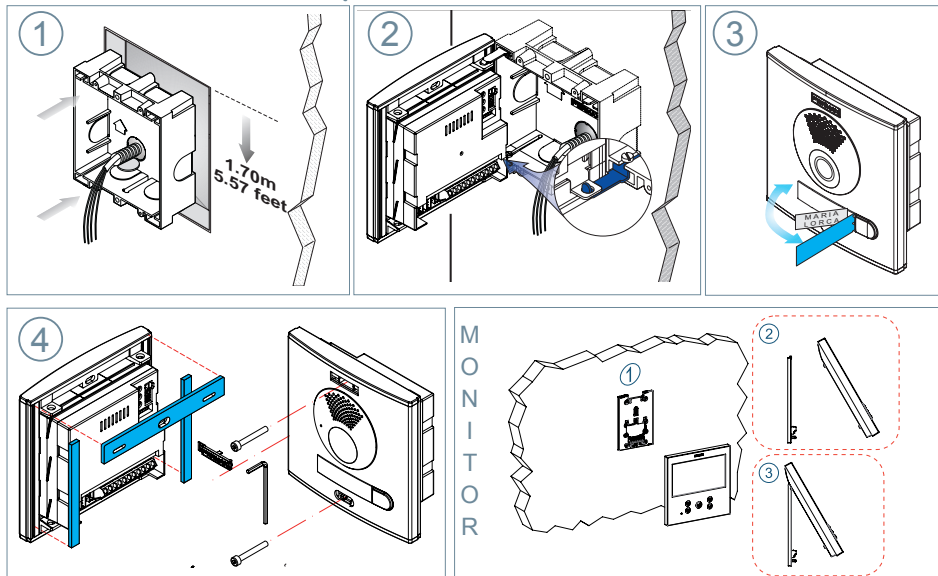

KONFIGURACJA

MONITOR VEO XL WIFI DUOX PLUS

Monitor dostarczony w zestawie JEST JUŻ ZAPROGRAMOWANY FABRYCZNIE.

W przypadku zestawu 2-liniowego programowane są oba monitory.

PRZYCISKI STERUJĄCE

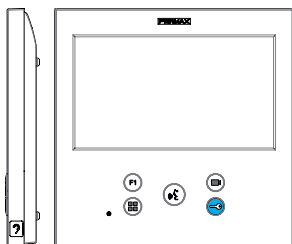



 Cyfrowe menu ustawień parametrów wewnętrznych i konfiguracji (jeśli monitor jest zaprogramowany).

 Naciśnij podczas rozmowy, aby otworzyć drzwi.

 W czasie odpoczynku zadzwoni do konsjerża (jeśli jest dostępny).

 Funkcja pomocnicza (należy skonsultować się z instalatorem).

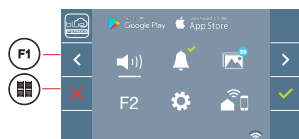

 W trybie gotowości naciśnij przycisk , a na wyświetlaczu pojawi się możliwość samodzielnego. Przełączania między różnymi panelami zewnętrznymi. Naciskając kolejno Panel 0, Panel 1, Panel główny, (w zależności od dostępności paneli).

 Aktywacja dźwiękowa i odkładanie słuchawki (tryb głośnomówiący).



 Monitor VEO XS WIFI jest wyposażony w menu OSD, którym można zarządzać za pomocą przycisków pod ekranem. Funkcje ikon na ekranie wyświetlane są kontekstowo w zależności od aktualnie aktywnego menu.

Biała linia poniżej ikony wskazuje aktualnie wybraną funkcję.

Wybierz za pomocą  /  żadaną ikonę i potwierdź za pomocą .





USTAWIENIA

1. USTAWIENIA MONITORA

USTAWIENIA VIDEO

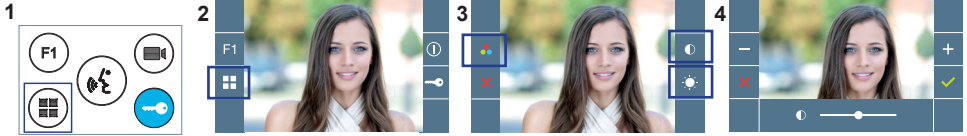
Mając obraz na monitorze po naciśnięciu przycisku  (lub podczas odbierania połączenia bez nawiązania komunikacji), naciśnij przycisk , aby wyświetlił ustawienia wideo.





Wybierz opcję ustawienia i zwiększ lub zmniejsz za pomocą  i .

REGULACJA DŹWIĘKU

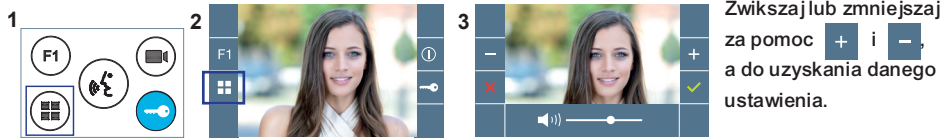
Gdy kanał audio jest otwarty, naciśnij przycisk , a na ekranie pojawi się menu tego ustawienia.



Zwiększaj lub zmniejszaj za pomocą  i , a do uzyskania danego ustawienia.

Uwaga: Maksymalny czas rozmowy: 90 sekund.

2. KONFIGURACJA PANELU

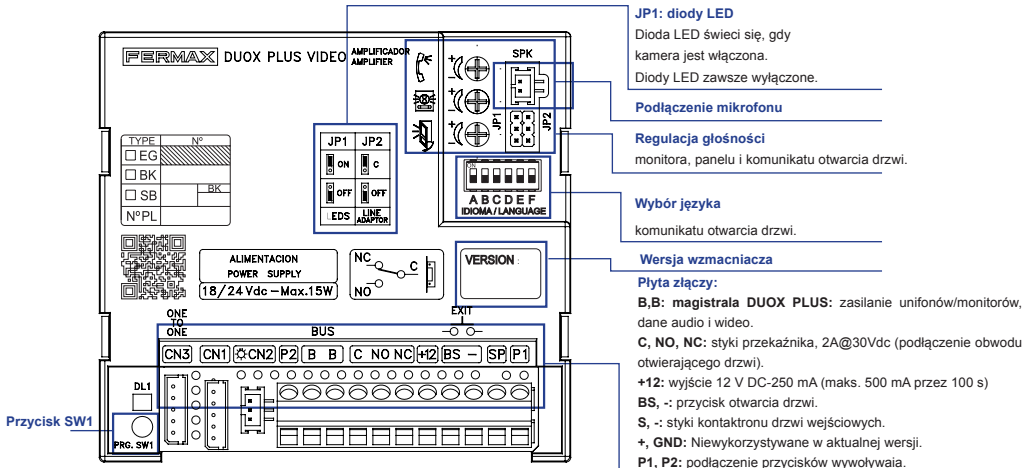

1 Wybór języka komunikatu "drzwi otwarte"



3. PROGRAMOWANIE ILOŚCI PANELI*

W przypadku większej ilości paneli należy zaprogramować ich liczbę

4. OSTROŚĆ KAMERY / CZAS AKTYWACJI OTWIERANIA DRZWI*

Suy do regulacji obrazu z kamery lub ustawiania czasu aktywacji odblokowania drzwi.

* Patrz Konfiguracja gosowa na kartach przycisków kod. 970048. Instrukcja doczona do tego urządzenia.

SPECYFIKACJA TECHNICZNA

SPECYFIKACJA PANELU ZEWNĘTRZNEGO

Zasilanie	18-24 Vdc
Pobór mocy w trybie czuwania	2,86 W
Pobór mocy w czasie pracy audio	6,30 (maks.) W
Moc audio w kierunku dom-ulica	1 W
Moc audio w kierunku od ulicy do mieszkania	0,15 W
Temperatura pracy	[-25°, +70°C] / [-13°, 158°F]
Głośność regulowana w obu kierunkach	

TABLICA WARTOŚCI

Czas aktywacji odblokowania drzwi	01...99 sek. (domyślnie: 03)
Czas aktywacji przycisku wyjścia	00...99 sek. (domyślnie: 06) / (wyłączony: 00)
Typ panelu	sub-block/block/general entry. (domyślnie: blok)
Numer panelu	0...9 (domyślnie: 00)
Panel MASTER	

SPECYFIKACJA TECHNICZNA MONITORA (ekran OSD TFT 7")

Zasilanie	18-24 Vdc
Pobór mocy w trybie czuwania (sparowany i podłączony)	1.3W
Maksymalne zużycie	9,9 W
Temperatura pracy	[-5°, +40°C] / [23°, 104°F]

SCHEMATY

SEKCJE TABELI - ODLEGŁOŚCI

Tabele przekrojów odległości - INSTALACJA ZESTAWU VIDEO

SEKCJA KABEL	 Maksymalna odległość (A) od zasilacza z filtrem do panelu (otwieranie drzwi) (i)		 Maksymalna odległość (B) od źródła filtra do najdalszego terminala	
	Odbiorniki na jedno mieszkanie bez dodatkowego źródła zasilania			
2 x 1 mm ²	1	250	1	250
	2		200	
	3		150	
2 x 0,5 mm ²	1	200	1	200
	2		120	
	3		70	
2 x 0,2 mm ²	1	80	1	100
	2		50	
	3		30	

-(i) W przypadku elektrycznego zwalniania blokady 12Vdc i maksymalnego poboru prądu 250mA, zasilanie ze wzmacniacza.

Uwaga: Aby uzyskać optymalną wydajność, zaleca się użycie tego samego typu kabla dla całej instalacji. Nie należy dublować przewodów.

SCHEMAT OKABLOWANIA DLA ZESTAWU 1N

Przykład: Podłączenie elektrozaczepu zasilanego napięciem 12VDC.

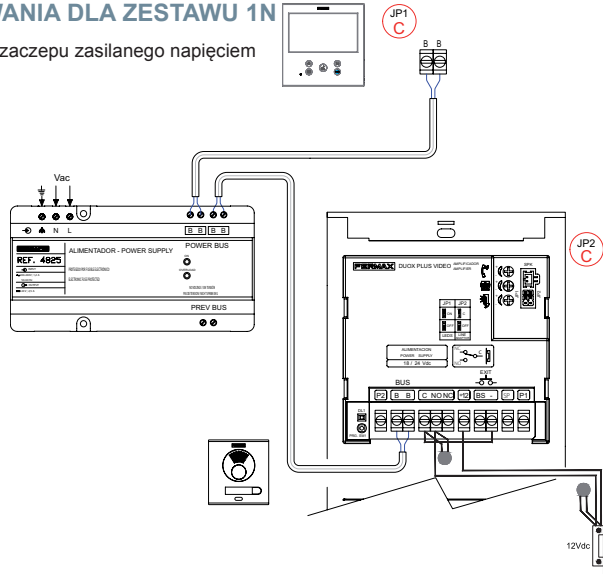

SCHEMAT OKABLOWANIA DLA ZESTAWU 2NR

Przykład: Podłączenie elektrozaczepu zasilanego napięciem 12VAC.

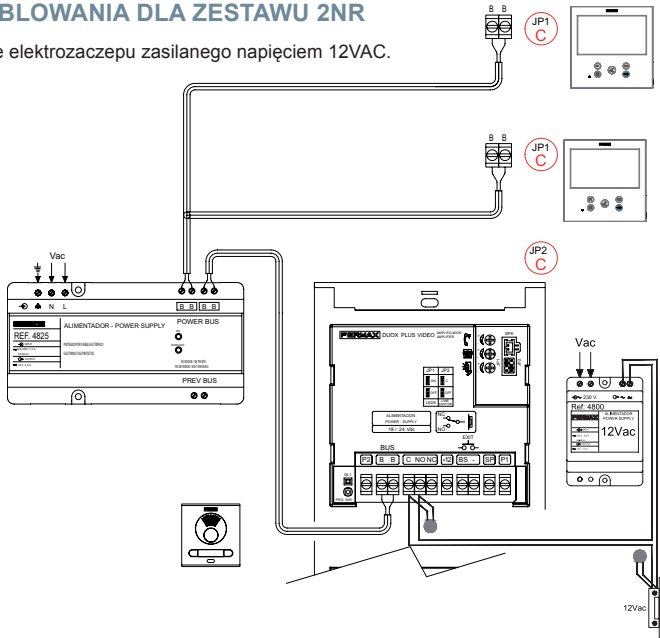

Uwaga: Niniejszy dokument przedstawia najbardziej podstawowe koncepcje szybkiego uruchomienia. Aby uzyskać więcej informacji, pobierz podręczniki ze strony www.fermax.com

- Panele wideo Cityline Duox Plus kod. 970050

- Monitor Duox Plus Veo XS WIFI kod. 970164

- Podręcznik techniczny systemu Duox Plus kod. 970122

USTAWIENIA UŻYTKOWNIKA

1. PAROWANIE. Przekazywanie połączeń.

Monitor VEO XL WIFI DUOX PLUS umożliwia dostęp do nowych usług oferowanych przez Fermax za pośrednictwem własnej chmury, takich jak przekierowanie połączeń. Aby móc korzystać z tej usługi, pierwszym krokiem jest podłączenie monitora do Internetu w procesie zwanym parowaniem.

Wymaga to użycia aplikacji Blue dostępnej w sklepie Google Play lub Apple Store.

Ustawienia monitora. Proces parowania.

Za pomocą aplikacji Blue, po zarejestrowaniu i zalogowaniu użytkownika, możemy rozpocząć proces parowania monitora.

Monitor DUOX PLUS jest kompatybilny tylko z WIFI 2,4 GHz.

Kroki podłączenia monitora do Internetu.

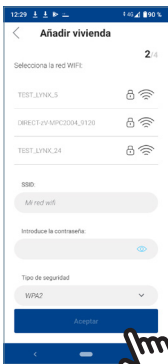
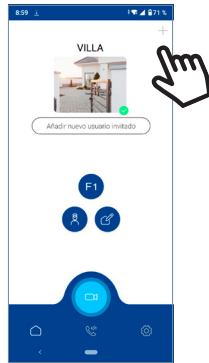

Android

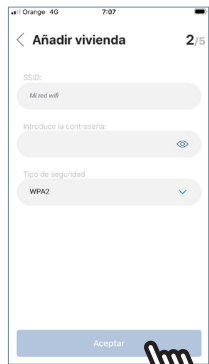

iOS

- 1 Otwórz aplikację i zaloguj się.
- 2 Kliknij przycisk **+** znajdujący się domyślnie na rodku ekranu lub w prawym górnym rogu, jeśli dostępne są jakieś mieszkania.

- 3 Aplikacja będzie wymagała od użytkownika wybrania danej sieci WIFI w celu podłączenia monitora.

Wybierz (w przypadku systemu Android) lub wprowadź (w przypadku systemu iOS) dany identyfikator SSID (nazw sieci), wprowadź prawidłowe hasło do połączenia i kliknij przycisk OK.

- 4 Aplikacja będzie wymagała od użytkownika otwarcia menu czności na monitorze



- 4a Naciśnij przycisk MENU , aby przejść do ekranu menu użytkownika.

- 4b** Zaleno między przyciskami i menu nawigacyjnym. Biała linia pod ikoną wskazuje funkcję, w której się znajdujemy.
- 4c** Wybierz menu czności na monitorze.

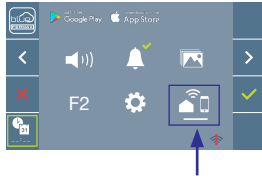

- 5** Po wybraniu menu czności potwierdź przyciskiem menu czności, potwierdź przyciskiem  aby do niego wejść

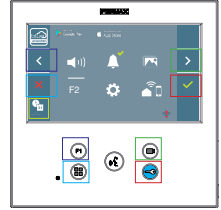

- 6** Monitor wyświetli na ekranie kod QR.

Adres MAC jest wyświetlany na ekranie w przypadku, gdy router Wi-Fi ma funkcję filtrowania adresów MAC.



- 7** Aplikacja będzie gotowa do zeskanowania kodu QR. Wskaż QR na ekranie monitora za pomocą telefonu komórkowego wyrównanego z zielonym kwadratem na ekranie telefonu komórkowego.

- 8** Aplikacja i monitor zaczną się ze sobą synchronizować. Biała dioda LED WiFi na monitorze zacznie migać.

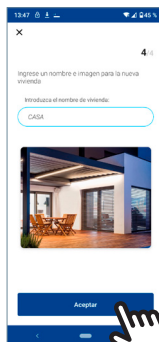
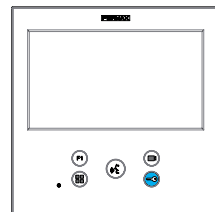
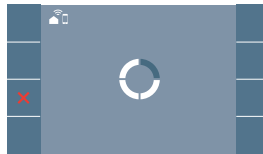

- 9** Zostanie wyświetlony ekran dodawania mieszkania:

- Liczba
 - Obraz (opcjonalnie)
- Wprowadź dane i naciśnij OK.

- 11 Jeli sie WIFI i podane dane uwierzytelniajace s prawidowe, monitor poczty si z Internetem, a proces zostanie pomylnie zakoczony.

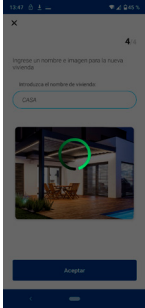

- 12 Aplikacja pokae nowy poczony dom jako dostpny i poczony (zielony haczyk ✓), a monitor pokae wynik poczenia jako pomylny. Biaa dioda WIFI pozostanie wczona. 



 Komunikat **potwierdzajcy** w procesie parowania monitora.

Jeli nie zostanie to zrobione poprawnie, pojawi si komunikat o b dzie w procesie parowania monitora.

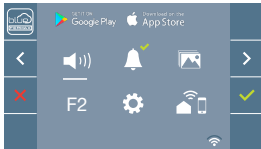

- 13 Po podczeniu, jeli menu uytkownika zostanie ponownie otwarte na monitorze, pokae si sygnau WIFI w prawym dolnym rogu.

Poziomy intensywnoci sygnau Wi-Fi wywietlanej w menu:



Od 0% do 20% lub niesparowany monitor.



Od 20% do 40%



Od 40% do 60%.



Od 60% do 80%.



Od 80% do 100%.



Automatyczny wlczenie

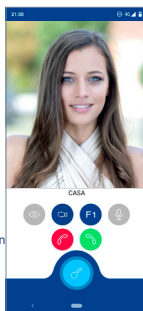

- 14 Aby przetestowa przekierowanie pocze, uytkownik moe wykona automatyczne wczenie i sprawdzi, czy czy si z panelem zewntrznym (o ile nie jest on uwywany).

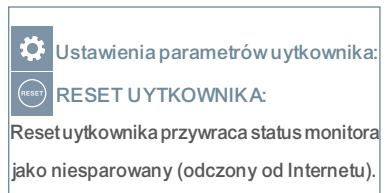

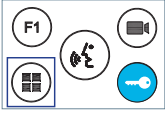
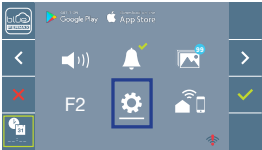
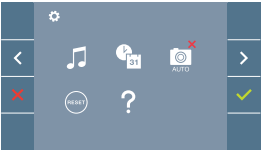

Uwaga: W tym rozdziale przedstawiono najbardziej podstawowe pojcia dotyczce szybkiego uruchamiania, aby uzyskac wiecej informacji, pobierz instrukcj **Aplikacja na telefon komorkowy DUOX PLUS Blue kod. 970156** na stronie www.fermax.com.

2. PARAMETRY UŻYTKOWNIKA: Dostęp do ekranu parametrów użytkownika.

1  2  3 



2.1 Ustawienia daty i godziny



2.2 Przechwytywanie obrazu

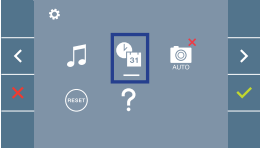
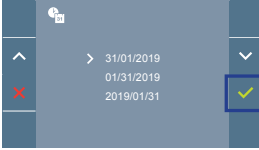

Wybierz za pomoc > ikon  i potwierd przyciskiem .



2.1 USTAWIENIA DATY I GODZINY

Monitor WIFI automatycznie synchronizuje czas ze strefy czasowej, w której jest zainstalowany, o ile jest sparowany i podłączony do Internetu. W takim przypadku nie jest możliwa zmiana daty i godziny.

1  2  3 

Wybierz ikon  za pomoc > i potwierd za pomoc .

Wybierz za pomoc   potwierd za pomoc .

Wybierz dat i godzin za pomoc   i potwierd . Aby porusza si po ustawieniach >

Niezaprogramowana data: 01/01/2019 (domyślna). Pojawi się ikona  wskazująca, że data jest nieprawidłowa (data domyślna). Po utracie zasilania przywracana jest data domyślna.

Uwaga: Jeśli obraz zostanie zarejestrowany z niezaprogramowaną datą, zostanie wyświetlona ikona .

Ikony powiadomień przy niezaprogramowanej dacie:

Ekran menu użytkownika

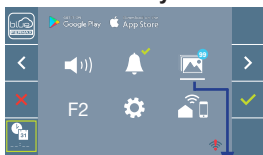

Przeglądarka obrazów

Ekran komunikacji



Ekran wyświetlania obrazu

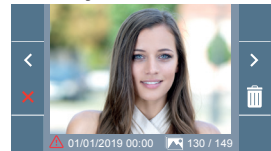



2.2 AKTYWACJA / DEZAKTYWACJA PRZECHWYTYWANIA OBRAZÓW

Monitor może wykonać automatyczne zdjęcie w ciągu 3 sekund od odebrania wywołania ze stacji bramowej. Ze względu na przepisy Unii Europejskiej dotyczące ochrony danych (UE) 2016/679, robienie zdjęć może być ograniczone. Domyślnie funkcja ta jest wyłączona; można ją aktywować z poziomu monitora na własne ryzyko.

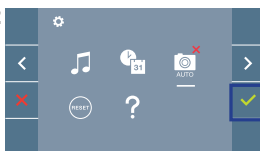
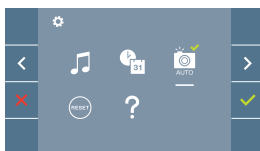
Może również wprowadzić obowiązek umieszczenia znaku obok panelu zewnętrznego wskazującego, że monitor może przechwytywać obrazy. Można go pobrać ze strony <https://www.fermax.com/spain/corporate/utilidades.html>.

1  2  3 

Wybierz ikon  za pomoc > i potwierd za pomoc .

Nacnij , aby wczy/ wyczy funkcj.

es.

Este producto está protegido con las siguientes patentes y modelos de utilidad:

PATENTES: US 9215410, US 9762852, BE1023440, AU2014203706.

MODELOS DE UTILIDAD: ES1187384U, ES1141495U, FR3038192, DE202016000632U1, CN205987229(U).

en.

This product is protected with the following patents and utility models:

PATENTS: US 9215410, US 9762852, BE1023440, AU2014203706.

UTILITY MODELS: ES1187384U, ES1141495U, FR3038192, DE202016000632U1, CN205987229(U).

fr.

Ce produit est protégé par les brevets et modèles d'utilité suivants:

BREVETS: US 9215410, US 9762852, BE1023440, AU2014203706.

MODÈLES UTILITAIRES: ES1187384U, ES1141495U, FR3038192, DE202016000632U1, CN205987229(U).

de.

Dieses Produkt ist durch die folgenden Patente und Gebrauchsmuster geschützt:

PATENTE: US 9215410, US 9762852, BE1023440, AU2014203706.

NUTZMODELLE: ES1187384U, ES1141495U, FR3038192, DE202016000632U1, CN205987229(U).

pt.

Este produto está protegido com as seguintes patentes e modelos de utilidade:

PATENTES: US 9215410, US 9762852, BE1023440, AU2014203706.

MODELOS DE UTILIDADE: ES1187384U, ES1141495U, FR3038192, DE202016000632U1, CN205987229(U).

pl.

Ten produkt jest chroniony następującymi patentami i wzorami użytkowymi:

PATENTY: US 9215410, US 9762852, BE1023440, AU2014203706.

MODELOS DE UTILIDAD: ES1187384U, ES1141495U, FR3038192, DE202016000632U1, CN205987229(U).

- es. El equipo que ha adquirido está identificado según Directiva 2012/19/UE sobre Residuos de aparatos eléctricos y electrónicos. Mas info:
- en. The device you have purchased is identified under Directive 2012/19/EU on waste electrical and electronic equipment. More info:
- fr. L'appareil que vous avez acheté porte un marquage conforme à la directive 2012/19/UE relative aux déchets d'équipements électriques et électroniques (DEEE). En savoir plus :
- de. Das erworbene Gerät fällt unter die Richtlinien 2012/19/EU über Elektro- und Elektronik-Altgeräte. Weitere Information:
- pt. El O equipamento que adquiriu está identificado de acordo com a Diretiva 2012/19/UE relativa aos resíduos de equipamentos elétricos e eletrónicos. Mais informação:
- pl. Zakupiony sprzęt został zidentyfikowany zgodnie z dyrektywą 2012/19/UE w sprawie zużytego sprzętu elektrycznego i elektronicznego. Więcej informacji:





Avd. Tres Cruces, 133
46017 Valencia
Spain

Para más información, visitar www.fermax.com

Contacto: tec@fermax.com / www.fermax.com/contact

For extended information, visit www.fermax.com

Contact: tec@fermax.com / www.fermax.com/contact

Pour de plus amples renseignements, rendez-vous sur www.fermax.com

Contact : tec@fermax.com / www.fermax.com/contact

Für weitere Information siehe www.fermax.com

Kontakt: tec@fermax.com / www.fermax.com/contact

Para informação detalhada, visite www.fermax.com

Contacto: tec@fermax.com / www.fermax.com/contact

Więcej informacji można znaleźć na stronie www.fermax.com

Kontakt: tec@fermax.com / www.fermax.com/contact