



THE DISPLAY CHOICE
OF PROFESSIONALS™

PD-43Q, PD-55Q & PD-65Q LCD Display

User Manual

www.agneovo.com

TABLE OF CONTENTS

SAFETY INFORMATION	1
Federal Communications Commission (FCC) Notice (U.S. Only).....	1
CE	1
Polish Center for Testing and Certification Notice	1
Electric, Magnetic and Electromagnetic Fields (“EMF”)	2
Information for U.K. only.....	3
North Europe (Nordic Countries) Information.....	4
End-of-Life Disposal	5
Waste Electrical and Electronic Equipment-WEEE.....	5
Turkey RoHS.....	6
Ukraine RoHS	6
PRECAUTIONS	7
Cautions When Setting Up	7
Cautions When Using.....	8
Cleaning and Maintenance.....	8
Notice for the LCD Display	9
CHAPTER 1: PRODUCT DESCRIPTION.....	10
1.1 Unpacking	10
1.2 Package Contents	10
1.3 Preparing for the Installation	11
1.4 Wall Mounting Installation.....	11
1.4.1 VESA Grid	12
1.4.2 Ventilation Requirements for Enclosure Locating.....	13
1.5 Mounting in Portrait Position	13
1.6 LCD Display Overview	14
1.6.1 Control Panel.....	14
1.6.2 Input/Output Terminals	17
1.7 Remote Control	19
1.7.1 General Functions	19
1.7.2 ID Remote Control.....	20
1.7.3 Remote Control buttons on USB source	21
1.7.4 Inserting the Batteries in the Remote Control	23
1.7.5 Handling the Remote Control	23
1.7.6 Operating Range of the Remote Control.....	23
CHAPTER 2: MAKING CONNECTIONS.....	24
2.1 Connecting the Power	24
2.2 Connecting a Computer	25
2.2.1 Using DVI-I Input	25
2.2.2 Using DisplayPort Input.....	26
2.2.3 Using HDMI Input	26

TABLE OF CONTENTS

2.3 Connecting External Equipment (Video Player)	27
2.3.1 Using HDMI Video Input	27
2.4 Connecting Audio Equipment	28
2.4.1 Connecting an External Audio Device	28
2.5 Using the Card Reader	28
2.6 Connecting Multiple Displays in a Daisy-chain Configuration	29
2.6.1 Display Control Connection	29
2.7 IR Connection	30
2.8 IR Pass-Through Connection	30
CHAPTER 3: USING THE LCD DISPLAY	31
3.1 Turning on the Power	31
3.1.1 Initial Setup	31
3.2 Selecting the Input Source Signal	33
3.3 Adjusting the Volume	33
3.4 Changing the Picture Format	34
CHAPTER 4: USB SOURCE	35
4.1 Accessing the USB Menu	35
4.2 Using the USB Menu	36
4.2.1 Creating a Playlist	36
4.2.2 Modifying a Playlist	38
4.2.3 Playing Files in a Playlist	39
4.2.4 USB Menu Settings	39
4.3 Admin Mode	40
4.3.1 Entering the Admin Mode	40
4.3.2 System Settings	41
4.3.3 Accessing Network Settings in Admin Mode	42
4.3.4 Managing Storage in Admin Mode	43
CHAPTER 5: ON SCREEN DISPLAY MENU	44
5.1 Using the OSD Menu	44
5.2 OSD Menu Tree	46
CHAPTER 6: ADJUSTING THE LCD DISPLAY	49
6.1 Picture Settings	49
6.2 Screen Settings	53
6.3 Audio Settings	56
6.4 Configuration1 Settings	58
6.5 Configuration2 Settings	62
6.6 Advanced option Settings	65

TABLE OF CONTENTS

CHAPTER 7: APPENDIX.....	77
7.1 Warning Messages.....	77
7.2 Supported Media Formats.....	77
7.3 Input Mode	79
7.4 Cleaning	80
7.5 Troubleshooting.....	81
7.6 Transporting the LCD Display	82
CHAPTER 8: SPECIFICATIONS	85
8.1 Display Specifications	85
8.2 Display Dimensions.....	86

SAFETY INFORMATION

Federal Communications Commission (FCC) Notice (U.S. Only)



This equipment has been tested and found to comply with the limits for a Class A digital device, pursuant to part 15 of the FCC Rules. These limits are designed to provide reasonable protection against harmful interference when the equipment is operated in a commercial environment. This equipment generates, uses, and can radiate radio frequency energy and, if not installed and used in accordance with the instruction manual, may cause harmful interference to radio communications. Operation of this equipment in a residential area is likely to cause harmful interference in which case the user will be required to correct the interference at his own expense.



Changes or modifications not expressly approved by the party responsible for compliance could void the user's authority to operate the equipment.

Use only an RF shielded cable that was supplied with the display when connecting this display to a computer device.

To prevent damage which may result in fire or shock hazard, do not expose this appliance to rain or excessive moisture.

THIS CLASS A DIGITAL APPARATUS MEETS ALL REQUIREMENTS OF THE CANADIAN INTERFERENCE CAUSING EQUIPMENT REGULATIONS.



This device complies with part 15 of the FCC Rules. Operation is subject to the following two conditions: (1) This device may not cause harmful interference, and (2) this device must accept any interference received, including interference that may cause undesired operation.

CE



WARNING: This equipment is compliant with Class A of EN55032/CISPR 32. In a residential environment this equipment may cause radio interference.

Polish Center for Testing and Certification Notice

The equipment should draw power from a socket with an attached protection circuit (a three-prong socket). All equipment that works together (computer, display, printer, and so on) should have the same power supply source.

The phasing conductor of the room's electrical installation should have a reserve short-circuit protection device in the form of a fuse with a nominal value no larger than 16 amperes (A).

To completely switch off the equipment, the power supply cable must be removed from the power supply socket, which should be located near the equipment and easily accessible.

A protection mark "B" confirms that the equipment is in compliance with the protection usage requirements of standards PN-93/T-42107 and PN-89/E-06251.

SAFETY INFORMATION

Wymagania Polskiego Centrum Badań i Certyfikacji

Urządzenie powinno być zasilane z gniazda z przyłączonym obwodem ochronnym (gniazdo z kolkiem). Współpracujące ze sobą urządzenia (komputer, monitor, drukarka) powinny być zasilane z tego samego źródła.

Instalacja elektryczna pomieszczenia powinna zawierać w przewodzie fazowym rezerwową ochronę przed zwarciami, w postaci bezpiecznika o wartości znamionowej nie większej niż 16A (amperów).

W celu całkowitego wyłączenia urządzenia z sieci zasilania, należy wyjąć wtyczkę kabla zasilającego z gniazdka, które powinno znajdować się w pobliżu urządzenia i być łatwo dostępne.

Znak bezpieczeństwa "B" potwierdza zgodność urządzenia z wymaganiami bezpieczeństwa użytkownika zawartymi w PN-93/T-42107 i PN-89/E-06251.

Pozostałe instrukcje bezpieczeństwa

- Nie należy używać wtyczek adapterowych lub usuwać kolka obwodu ochronnego z wtyczki. Jeżeli konieczne jest użycie przedłużacza to należy użyć przedłużacza 3-żyłowego z prawidłowo połączonym przewodem ochronnym.
- System komputerowy należy zabezpieczyć przed nagłymi, chwilowymi wzrostami lub spadkami napięcia, używając eliminatora przepięć, urządzenia dopasowującego lub bezzakłóceńowego źródła zasilania.
- Należy upewnić się, aby nic nie leżało na kablach systemu komputerowego, oraz aby kable nie były umieszczone w miejscu, gdzie można byłoby na nie nadeptywać lub potykać się o nie.
- Nie należy rozlewać napojów ani innych płynów na system komputerowy.
- Nie należy wpychać żadnych przedmiotów do otworów systemu komputerowego, gdyż może to spowodować pożar lub porażenie prądem, poprzez zwarcie elementów wewnętrznych.
- System komputerowy powinien znajdować się z dala od grzejników i źródeł ciepła. Ponadto, nie należy blokować otworów wentylacyjnych. Należy unikać kładzenia luźnych papierów pod komputer oraz umieszczania komputera w ciasnym miejscu bez możliwości cyrkulacji powietrza wokół niego.

Electric, Magnetic and Electromagnetic Fields ("EMF")

- We manufacture and sell many products targeted at consumers, which, like any electronic apparatus, in general have the ability to emit and receive electromagnetic signals.
- One of our leading Business Principles is to take all necessary health and safety measures for our products, to comply with all applicable legal requirements and to stay well within the EMF standards applicable at the time of producing the products.
- We are committed to develop, produce and market products that cause no adverse health effects.
- We confirm that if its products are handled properly for their intended use, they are safe to use according to scientific evidence available today.
- We play an active role in the development of international EMF and safety standards, enabling us to anticipate further developments in standardization for early integration in its products.

SAFETY INFORMATION

Information for U.K. only

WARNING - THIS APPLIANCE MUST BE EARTHED.

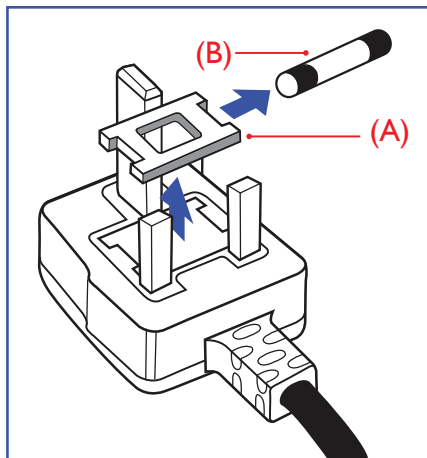

Important:

This apparatus is supplied with an approved moulded 13A plug. To change a fuse in this type of plug proceed as follows:

- 1 Remove fuse cover and fuse.
- 2 Fit new fuse which should be a BS 1362 5A, A.S.T.A. or BSI approved type.
- 3 Refit the fuse cover.

If the fitted plug is not suitable for your socket outlets, it should be cut off and an appropriate 3-pin plug fitted in its place.

If the mains plug contains a fuse, this should have a value of 5A. If a plug without a fuse is used, the fuse at the distribution board should not be greater than 5A.



Note:

The severed plug must be destroyed to avoid a possible shock hazard should it be inserted into a 13A socket elsewhere.

SAFETY INFORMATION

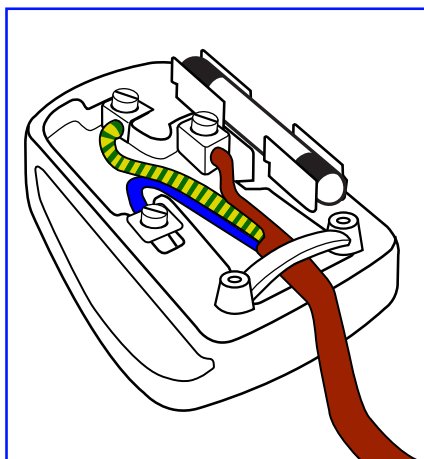

How to connect a plug

The wires in the mains lead are coloured in accordance with the following code:

BLUE - "NEUTRAL" ("N")

BROWN - "LIVE" ("L")

GREEN & YELLOW - "EARTH" ("E")

- The GREEN & YELLOW wire must be connected to the terminal in the plug which is marked with the letter "E" or by the Earth symbol or coloured GREEN or GREEN & YELLOW.
- The BLUE wire must be connected to the terminal which is marked with the letter "N" or coloured BLACK.
- The BROWN wire must be connected to the terminal which marked with the letter "L" or coloured RED.

Before replacing the plug cover, make certain that the cord grip is clamped over the sheath of the lead - not simply over the three wires.

North Europe (Nordic Countries) Information

Placering/Ventilation

WARNING: FÖRSÄKRA DIG OM ATT HUVUDBRYTARE OCH UTTAG ÄR LÄTÅTKOMLIGA, NÄR DU STÄLLER DIN UTRUSTNING PÅPLATS.

Placering/Ventilation

ADVARSEL: SØRG VED PLACERINGEN FOR, AT NETLEDNINGENS STIK OG STIKKONTAKT ER NEMT TILGÆNGLIGE.

Paikka/Ilmankierto

VAROITUS: SIJOITA LAITE SITEN, ETTÄ VERKKOJOHTO VOIDAAN TARVITTAESSA HELPOSTI IRROTTAA PISTORASIESTA.

Plassering/Ventilasjon

ADVARSEL: NÅR DETTE UTSTYRET PLASSERES, MÅ DU PASSE PÅ AT KONTAKTENE FOR STØMTILFØRSEL ER LETTE Å NÅ.

SAFETY INFORMATION

End-of-Life Disposal

Your new Public Information Display contains materials that can be recycled and reused. Specialized companies can recycle your product to increase the amount of reusable materials and to minimize the amount to be disposed of.

Please find out about the local regulations on how to dispose of your old display from your local dealer.

(For customers in Canada and U.S.A.)

This product may contain lead and/or mercury. Dispose of in accordance to local-state and federal regulations. For additional information on recycling contact www.eia.org (Consumer Education Initiative).

WEEE

Disposal of Waste Equipment by Users in Private Household in the European Union.

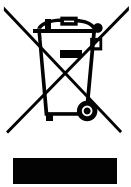

This symbol on the product or on its packaging indicates that this product must not be disposed of with your other household waste. Instead, it is your responsibility to dispose of your waste equipment by handing it over to a designated collection point for the recycling of waste electrical and electronic equipment. The separate collection and recycling of your waste equipment at the time of disposal will help to conserve natural resources and ensure that it is recycled in a manner that protects human health and the environment. For more information about where you can drop off your waste equipment for recycling, please contact your local city office, your household waste disposal service or the shop where you purchased the product.

For Private Households in the European Union. To help conserve natural resources and ensure the product is recycled in a manner that protects human health and the environment, we would like to bring your attention to the following:

- The crossed-out dustbin on the device or outer packaging indicates the product is compliant with European WEEE (Waste Electrical and Electronic Equipment) Directive
- Always dispose of the old devices separately from household waste
- Batteries should be removed beforehand and disposed separately to the right collection system
- You are responsible with regard to the deletion of personal data on old devices before disposal
- Private households can hand in their old devices free of charge
- For more information about where you can drop off your waste equipment for recycling, please contact your local city office, your household waste disposal service or the shop where you purchased the product

SAFETY INFORMATION

Attention users in United States:

Please dispose of according to all Local, State and Federal Laws. For the disposal or recycling information, contact: www.mygreenelectronics.com or www.eiae.org.

End of Life Directives-Recycling



Your new Public Information Display contains several materials that can be recycled for new users.

Please dispose of according to all Local, State, and Federal laws.

Restriction on Hazardous Substances statement (India)

This product complies with the "India E-waste Rule 2011" and prohibits use of lead, mercury, hexavalent chromium, polybrominated biphenyls or polybrominated diphenyl ethers in concentrations exceeding 0.1 weight % and 0.01 weight % for cadmium, except for the exemptions set in Schedule 2 of the Rule.

E-Waste Declaration for India



This symbol on the product or on its packaging indicates that this product must not be disposed of with your other household waste. Instead it is your responsibility to dispose of your waste equipment by handing it over to a designated collection point for the recycling of waste electrical and electronic equipment. The separate collection and recycling of your waste equipment at the time of disposal will help to conserve natural resources and ensure that it is recycled in a manner that protects human health and the environment.

Batteries



For EU: The crossed-out wheeled bin implies that used batteries should not be put to the general household waste! There is a separate collection system for used batteries, to allow proper treatment and recycling in accordance with legislation.

Please contact your local authority for details on the collection and recycling schemes.

For Switzerland: The used battery is to be returned to the selling point.

For other non-EU countries: Please contact your local authority for correct method of disposal of the used battery.

According to EU directive 2006/66/EC, the battery can't be disposed improperly. The battery shall be separated to collect by local service.

Turkey RoHS

Türkiye Cumhuriyeti: EEE Yönetmeliğine Uygundur.

Ukraine RoHS

Обладнання відповідає вимогам Технічного регламенту щодо обмеження використання деяких небезпечних речовин в електричному та електронному обладнанні, затвердженого постановою Кабінету Міністрів України від 3 грудня 2008 № 1057.

PRECAUTIONS

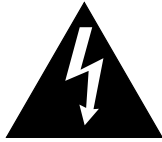

Symbols used in this manual

	This icon indicates the existence of a potential hazard that could result in personal injury or damage to the product.
	This icon indicates important operating and servicing information.

Notice

- Read this User Manual carefully before using the LCD display and keep it for future reference.
- The product specifications and other information provided in this User Manual are for reference only. All information is subject to change without notice. Updated content can be downloaded from our web site at www.agneovo.com.
- To protect your rights as a consumer, do not remove any stickers from the LCD display. Doing so may affect the determination of the warranty period.

Cautions When Setting Up

- Do not place the LCD display near heat sources, such as a heater, exhaust vent, or in direct sunlight.
- Do not cover or block the ventilation holes in the housing.
- Place the LCD display on a stable area. Do not place the LCD display where it may be subject to vibration or shock.
- Place the LCD display in a well-ventilated area.
- Do not place the LCD display outdoors.
- To avoid the risk of shock or permanent damage to the set, do not expose the display to dust, rain, water or an excessively moist environment.
- Do not spill liquid or insert sharp objects into the LCD display through the ventilation holes. Doing so may cause accidental fire, electric shock or damage the LCD display.

PRECAUTIONS

Cautions When Using

- Use only the power cord supplied with the LCD display.
- The power outlet should be installed near the LCD display and be easily accessible.
- If an extension cord is used with the LCD display, ensure that the total current consumption plugged into the power outlet does not exceed the ampere rating.
- Do not allow anything to rest on the power cord. Do not place the LCD display where the power cord may be stepped on.
- If the LCD display will not be used for an indefinite period of time, unplug the power cord from the power outlet.
- To disconnect the power cord, grasp and pull by the plug head. Do not tug on the cord; doing so may cause fire or electric shock.
- Do not unplug or touch the power cord with wet hands.
- When turning off the display by detaching the power cord, wait 6 seconds before re-attaching the power cord for normal operation.
- Do not knock or drop the display during operation or transportation.

Cleaning and Maintenance

- To protect your display from possible damage, do not put excessive pressure on the LCD panel. When moving your display, grasp the frame to lift; do not lift the display by placing your hand or fingers on the LCD panel.
- Unplug the display if you need to clean it with a slightly damp cloth. The screen may be wiped with a dry cloth when the power is off. However, never use organic solvent, such as, alcohol, or ammonia-based liquids to clean your display.
- If your display becomes wet, wipe it with dry cloth as soon as possible.
- If a foreign substance or water gets in your display, turn the power off immediately and disconnect the power cord. Then remove the foreign substance or water, and send the unit to the maintenance center.
- In order to maintain the best performance of your display and ensure a longer lifetime, we strongly recommend using the display in a location that falls within the following temperature and humidity ranges.
 - ◆ Temperature: 0-40°C (32-104°F)
 - ◆ Humidity: 20-80% RH



Warning:



Unplug the power cord from the power outlet and refer to qualified service

personnel under the following conditions:

- ◆ When the power cord is damaged.
- ◆ If the LCD display has been dropped or the housing has been damaged.
- ◆ If the LCD display emits smoke or a distinct odor.

PRECAUTIONS

Notice for the LCD Display

- In order to maintain the stable luminous performance, it is recommended to use low brightness setting.
- Due to the lifespan of the lamp, it is normal that the brightness quality of the LCD display may decrease with time.
- When static images are displayed for long periods of time, the image may cause an imprint on the LCD display. This is called image retention or burn-in.
 - ◆ To prevent image retention, do any of the following:
 - Set the LCD display to turn off after a few minutes of being idle.
 - Use a screen saver that has moving graphics or a blank white image.
 - Execute the ANTI-BURN-IN function of the LCD display. See **Configuration 1 > Panel Saving > ANTI-BURN-IN** section.
 - Switch desktop backgrounds regularly.
 - Adjust the LCD display to low brightness settings.
 - Turn off the LCD display when the system is not in use.
 - ◆ Things to do when the LCD display shows image retention:
 - Turn off the LCD display for extended periods of time. It can be several hours or several days.
 - Use a screen saver and run it for extended periods of time.
 - Use a black and white image and run it for extended periods of time.
- There are millions of micro transistors inside the LCD display. It is normal for a few transistors to be damaged and to produce spots. This is acceptable and is not considered a failure.
- **IMPORTANT:** Always activate a moving screen saver program when you leave your display unattended. Always activate a periodic screen refresh application if the unit will display unchanging static content. Uninterrupted display of still or static images over an extended period may cause “burn in”, also known as “after-imaging” or “ghost imaging”, on your screen. This is a well-known phenomenon in LCD panel technology. In most cases, the “burned in” or “after-imaging” or “ghost imaging” will disappear gradually over a period of time after the power has been switched off.
- **WARNING:** Severe “burn-in” or “after-image” or “ghost image” symptoms will not disappear and cannot be repaired. This is also not covered under the terms of your warranty.

CHAPTER 1: PRODUCT DESCRIPTION

1.1 Unpacking

- This product is packed in a packaging box which contains standard accessories.
- Any other optional accessories will be packed separately.
- Considering the size and weight of the display, it is recommended that this product is carried out by two persons.
- After opening the packaging box, ensure that the included items are in good condition and complete.

1.2 Package Contents

When unpacking, check if the following items are included in the package. If any of them is missing or damaged, contact your dealer.

LCD Display



Remote control

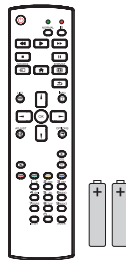

Quick Start Guide



HDMI cable

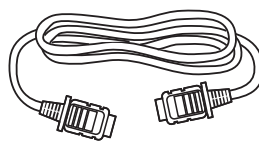

Power cord



RS 232 cable

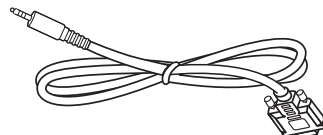

Note:

- ◆ Remote control is shipped with the supplied AAA batteries.
- ◆ For all other regions, apply a power cord that conforms to the AC voltage of the power socket and has been approved by and complies with the safety regulations of the particular country.
- ◆ You might like to save the package box and packing material for shipping the display.
- ◆ The pictures are for reference only. Actual items may vary upon shipment.

PRODUCT DESCRIPTION

1.3 Preparing for the Installation

- Due to the high power consumption, always use the plug exclusively designed for this product. If an extended line is required, please consult your service agent.
- The product should be installed on a flat surface to avoid tipping. The distance between the back of the product and the wall should be maintained for proper ventilation. Avoid installing the product in the kitchen, bathroom or any other places with high humidity so as not to shorten the service life of the electronic components.
- The product can normally operate only under 3000m in altitude. In installations at altitudes above 3000m, some abnormalities may be experienced.

1.4 Wall Mounting Installation

To mount this display to a wall, you will have to obtain a standard wall-mounting kit (commercially available). We recommend using a mounting interface that complies with TUV-GS and/or UL1678 standard in North America.

To wall-mount the LCD display, screw the mounting bracket to the VESA holes at the rear of the LCD display.

PD-43Q

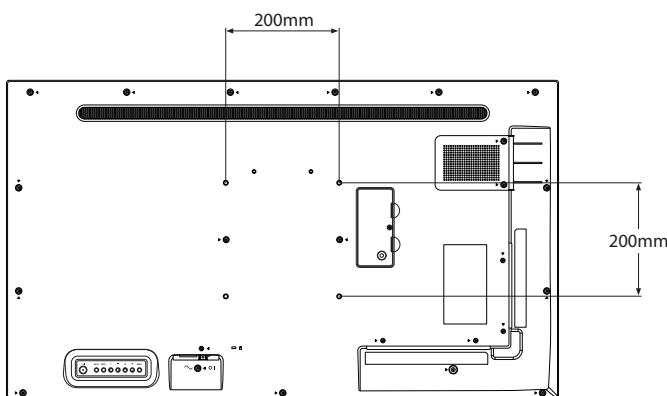

PD-55Q

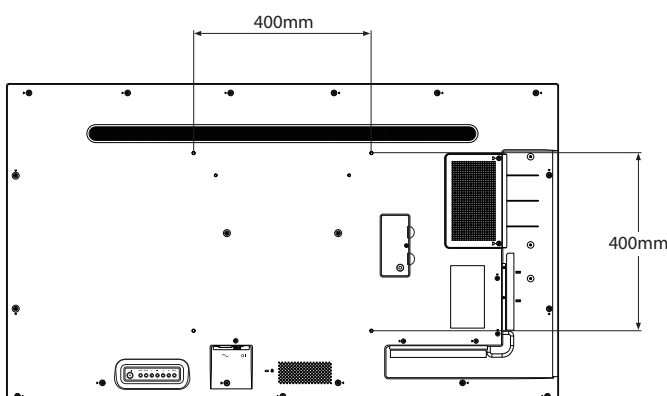

Warning:

- ◆ Do not press too hard on the LCD panel or edge of the frame, as this may cause the device to malfunction.

Note:

- ◆ Avoid the wall-mounting kit to block the ventilation holes on the back of the display.
- ◆ Secure the LCD display on a solid wall strong enough to bear its weight.
- ◆ Lay a protective sheet on a table, which was wrapped around the display when it was packaged, beneath the screen surface so as not to scratch the screen face.
- ◆ Ensure you have all accessories for mounting this display (wall mount, ceiling mount, etc).
- ◆ Follow the instructions that come with the base mounting kit. Failure to follow correct mounting procedures could result in damage to the equipment or injury to the user or installer. Product warranty does not cover damage caused by improper installation.

PRODUCT DESCRIPTION

PD-65Q

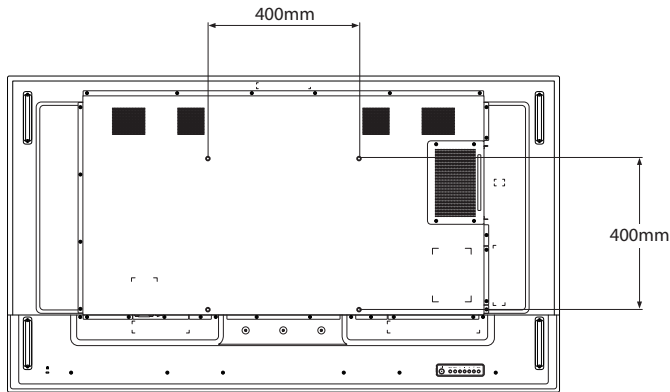

1.4.1 VESA Grid

Model Name	VESA Grid
PD-43Q	200(W) x 200(H) mm
PD-55Q	400(W) x 400(H) mm
PD-65Q	400(W) x 400(H) mm

Caution:

To prevent the display from falling:

- ◆ For wall or ceiling installation, we recommend installing the display with metal brackets which are commercially available. For detailed installation instructions, see the guide received with the respective bracket.
- ◆ To lessen the probability of injury and damage resulting from fall of the display in case of earthquake or other natural disaster, be sure to consult the bracket manufacturer for installation location.

Note:

- ◆ For PD-43Q / PD-55Q wall-mounting kits, use M6 mounting screws (having a length 10 mm longer than the thickness of the mounting bracket) and tighten them securely.
- ◆ For PD-65Q wall-mounting kits, use M8 mounting screws (having a length 15 mm longer than the thickness of the mounting bracket) and tighten them securely.
- ◆ Unit without base weight is 10.7 kg (PD-43Q), 16.6 kg (PD-55Q), or 27.8 kg (PD-65Q). The equipment and its associated mounting means still remain secure during the test. For use only with UL Listed Wall Mount Bracket with minimum weight/load is 14.9 kg (PD-43Q), 22.7 kg (PD-55Q), or 33.6 kg (PD-65Q).

PRODUCT DESCRIPTION

1.4.2 Ventilation Requirements for Enclosure Locating

To allow heat to disperse, leave space between surrounding objects as shown in the diagram below.

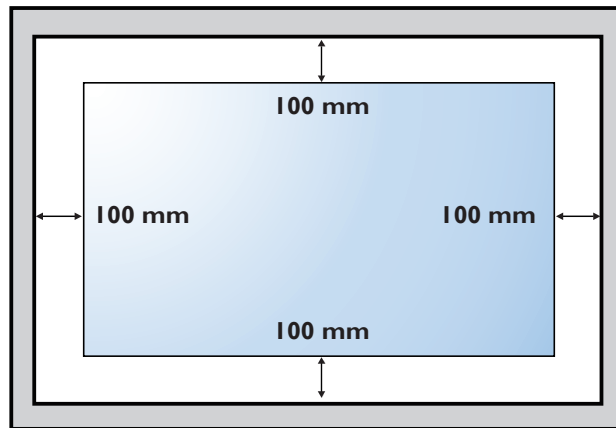

1.5 Mounting in Portrait Position

This display can be installed in portrait position.

Rotate 90 degrees counter-clockwise.

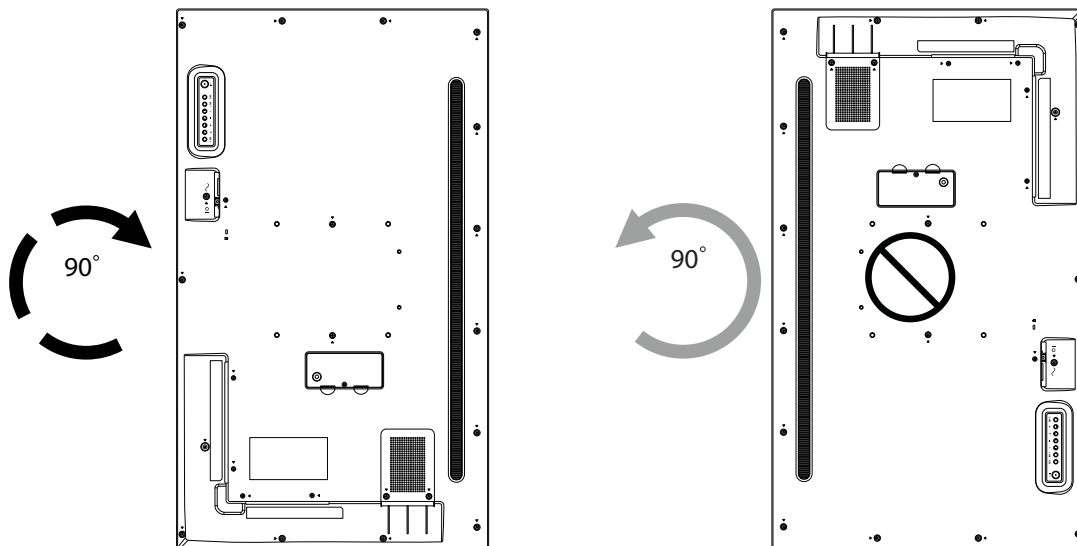

PRODUCT DESCRIPTION

1.6 LCD Display Overview

1.6.1 Control Panel

PD-43Q

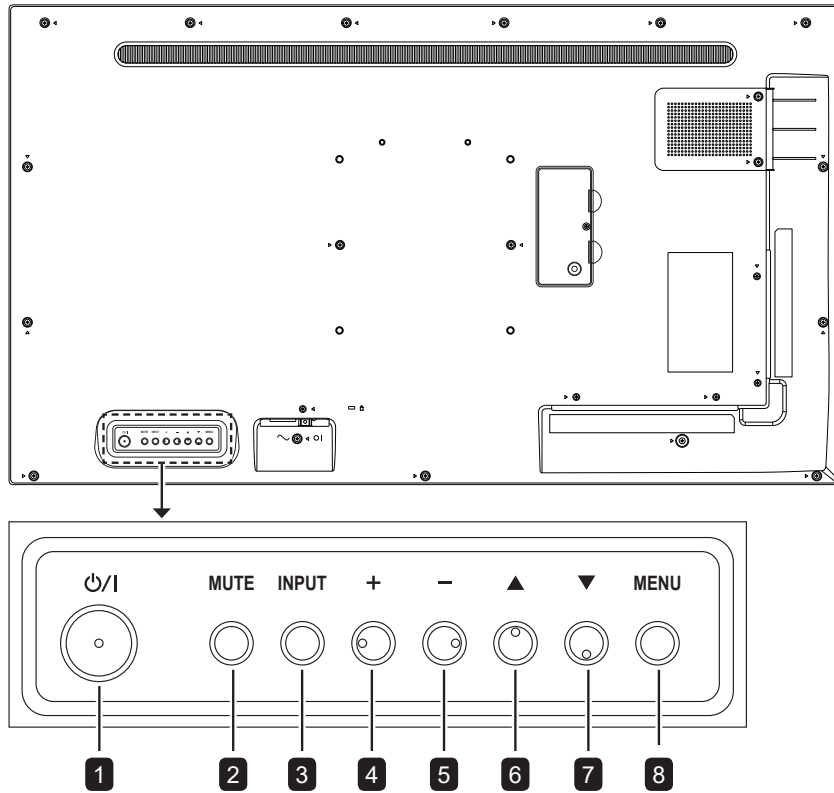

PD-55Q

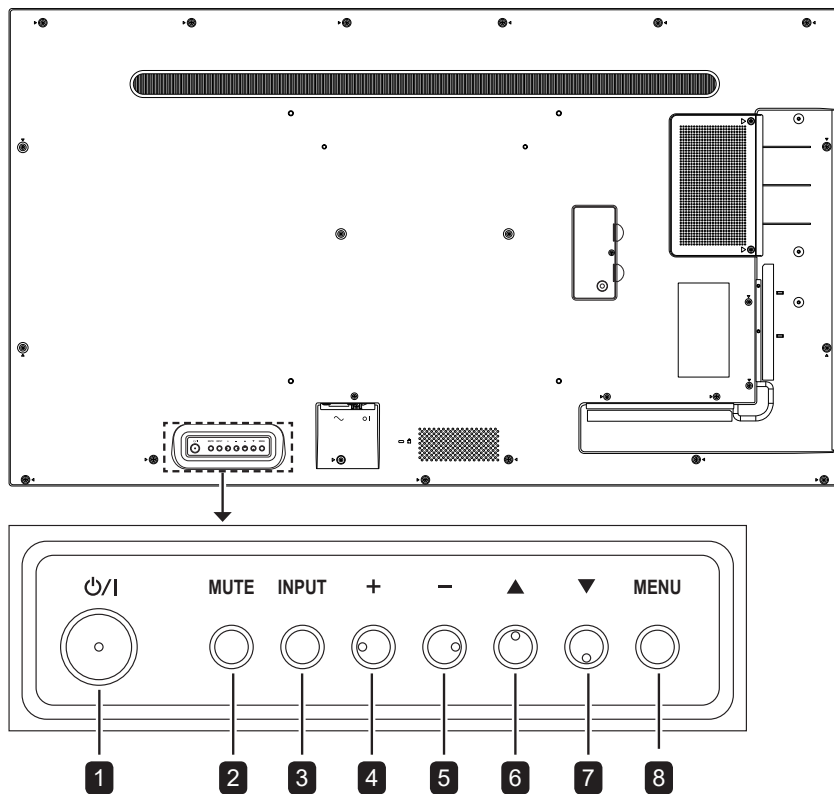

PRODUCT DESCRIPTION

PD-65Q

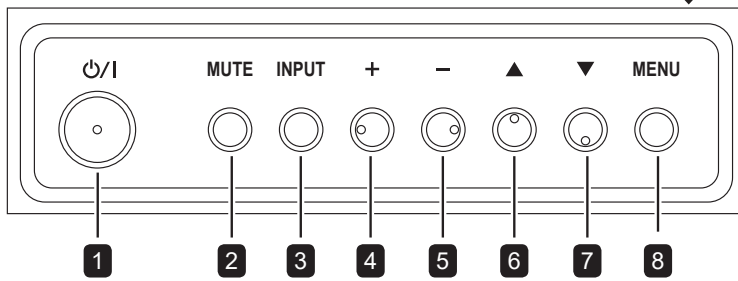
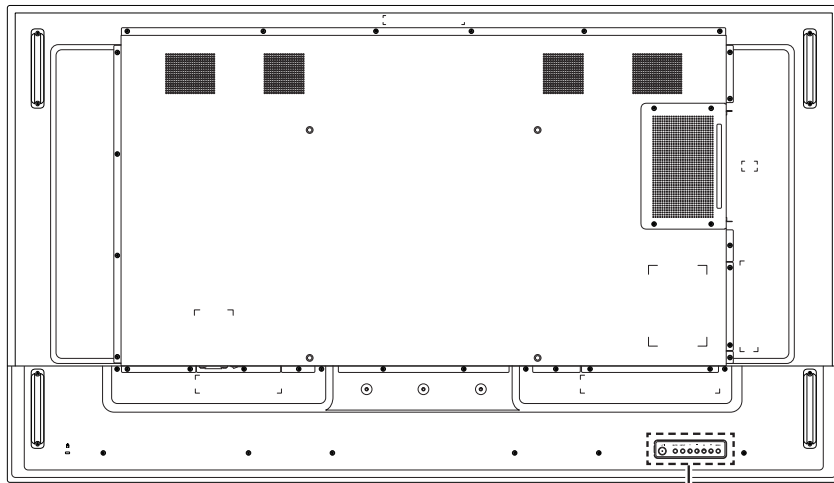

PRODUCT DESCRIPTION

1 [⏻/⏻] Power

Turn the display on or put the display to standby.

2 MUTE

Switch the audio mute ON/OFF.

3 INPUT

Choose the input source.

4 [⏮] Increase

- Enter the submenu while OSD menu is on.
- Increase the Volume level while OSD menu is off.

5 [⏭] Decrease

- Return to the previous menu while OSD menu is on.
- Decrease the Volume level while OSD menu is off.

6 [▲] Up

Move the highlight bar up to select an option or increase the adjustment while OSD menu is on.

7 [▼] Down

Move the highlight bar down to select an option or decrease the adjustment while OSD menu is on.

8 MENU

- Activate the OSD menu when OSD menu is off.
- Hide the OSD menu while OSD menu is on.

9 Remote control sensor and power status indicator

- Receive command signals from the remote control.
- Indicate the operating status of the display:
 - Lights green when the display is turned on
 - Lights red when the display is in standby mode
 - Blinks amber and red when "Advanced option, Schedule" is enabled
 - Blinks red when a failure has been detected
 - Lights off when the main power of the display is turned off

PRODUCT DESCRIPTION

1.6.2 Input/Output Terminals

PD-43Q

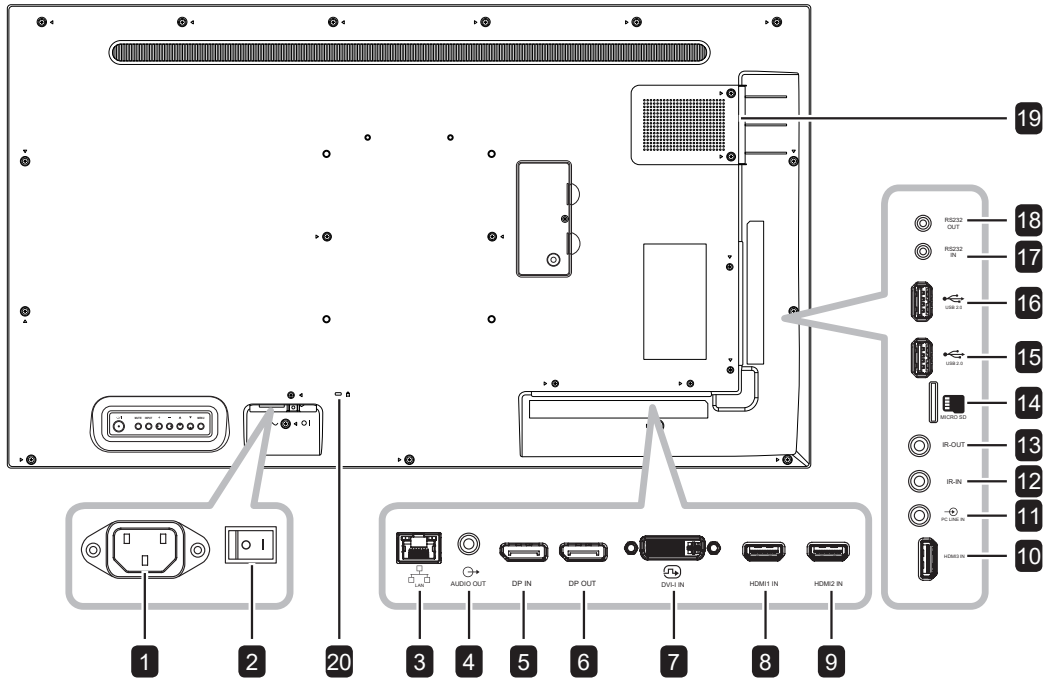

PD-55Q

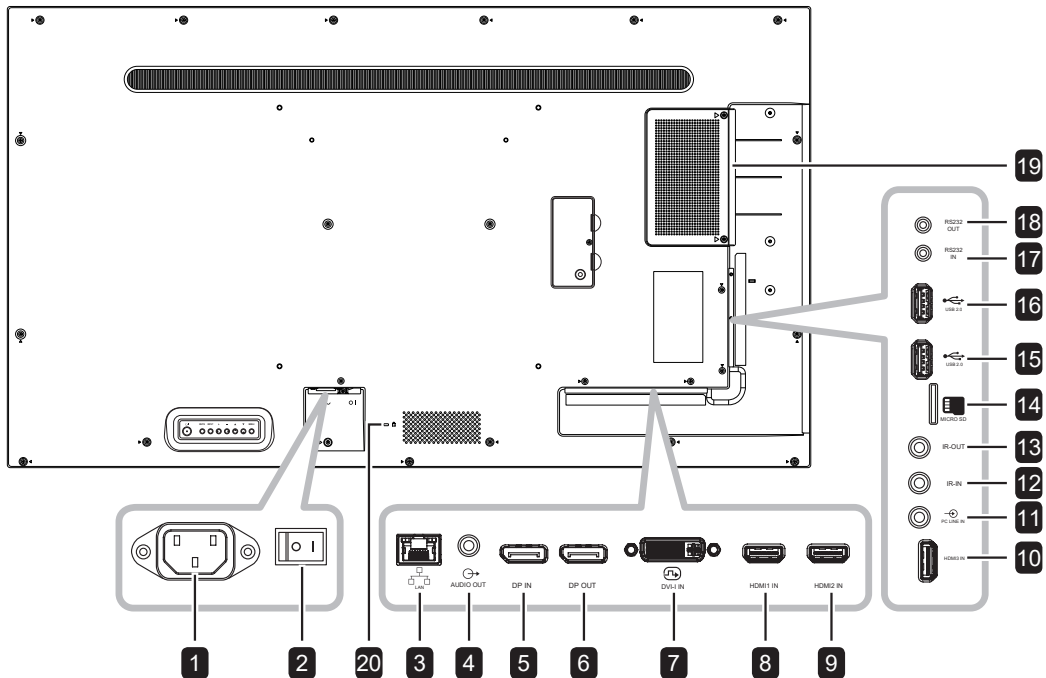

PRODUCT DESCRIPTION

PD-65Q

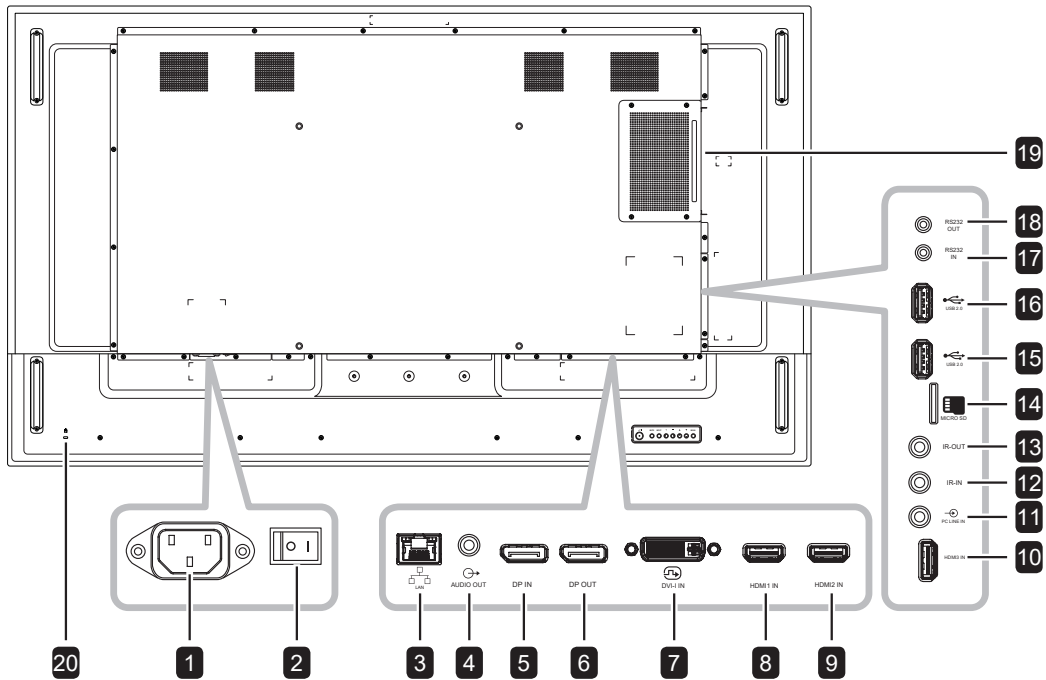

- 1 AC IN**
AC power input
 - 2 Main power switch**
Switch the main power on/off.
 - 3 LAN**
For internet connection with an Ethernet cable.
 - 4 AUDIO OUT**
Connect audio signals output (3.5 mm Stereo Audio Jack).
 - 5 DP IN**
Connect DisplayPort signals input.
 - 6 DP OUT**
Connect DisplayPort signals output.
 - 7 DVI-I IN**
Connect DVI signals input.
For VGA input, you can use either the DVI male to VGA adapter or the DVI to VGA cable.
 - 8 HDMI1 IN**
Connect HDMI signals input.
 - 9 HDMI2 IN**
Connect HDMI signals input.
 - 10 HDMI3 IN**
Connect HDMI signals input.
 - 11 PC LINE IN**
Connect audio signals input (3.5 mm Stereo Audio Jack).
 - 12 IR-IN**
IR signal input.
 - 13 IR-OUT**
IR signal output for the loop-through function.
- Note:**
- ◆ This display's remote control sensor will stop working if the jack [IR IN] is connected.
- 14 microSD Card Slot**
Insert a microSD memory card.
 - 15 USB 2.0 Port (Service / USB Playback Function)**
Connect USB 2.0 for service and USB playback.
 - 16 USB 2.0 Port (USB Playback Function)**
Connect USB 2.0 for USB playback.
 - 17 RS232 IN**
Connect RS232 input from external equipment.
 - 18 RS232 OUT**
Connect RS232 output to additional displays.
 - 19 SDM Slot**
Connect the SDM module.
 - 20 SECURITY LOCK**
Used for security and theft prevention.

PRODUCT DESCRIPTION

1.7 Remote Control

1.7.1 General Functions

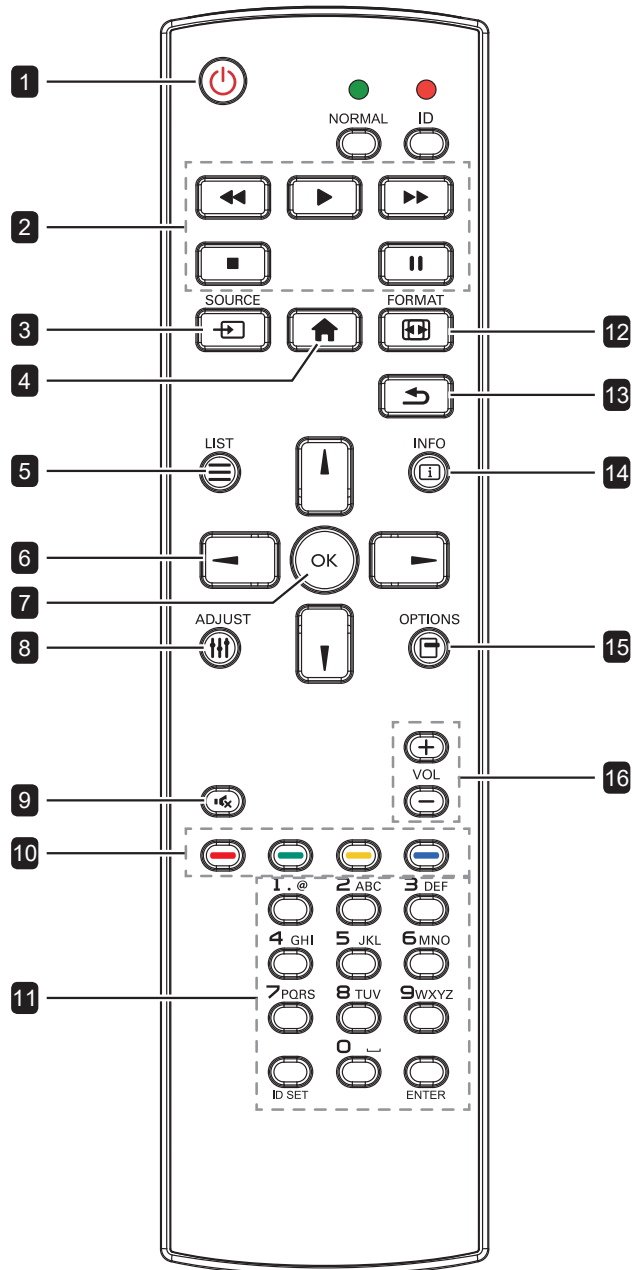

- 1 [POWER] POWER**
Turn the display on or to put the display into standby mode.
- 2 PLAY**
Control playback in multimedia mode.
- 3 [SOURCE] SOURCE**
Choose the input source.
- 4 [HOME] HOME**
Access the OSD menu.
- 5 [LIST] LIST**
No function.
- 6 [NAVIGATION] NAVIGATION buttons**
Navigate through menus and choose items.
- 7 [OK] OK**
Confirm an entry or selection.
- 8 [ADJUST] ADJUST**
Go to Auto Adjust (for VGA input only).
- 9 [MUTE] MUTE**
Turn the mute function on/off.
- 10 [COLOR] COLOR**
No function.
- 11 [Number/ ID SET/ ENTER]**
For ID setting only and enter text for network setting.
- 12 [FORMAT] FORMAT**
Change the aspect ratio.
- 13 [BACK] BACK**
Return to the previous menu or exit from the previous function.
- 14 [INFO] INFO**
View the information about the display.
- 15 [OPTIONS] OPTIONS**
Access currently available options [Toolbar], Media Player and PDF Player menus.
- 16 [VOLUME] VOLUME**
Adjust the volume level.

PRODUCT DESCRIPTION

1.7.2 ID Remote Control

You can set the remote control ID when you want to use this remote control on one of several different displays.

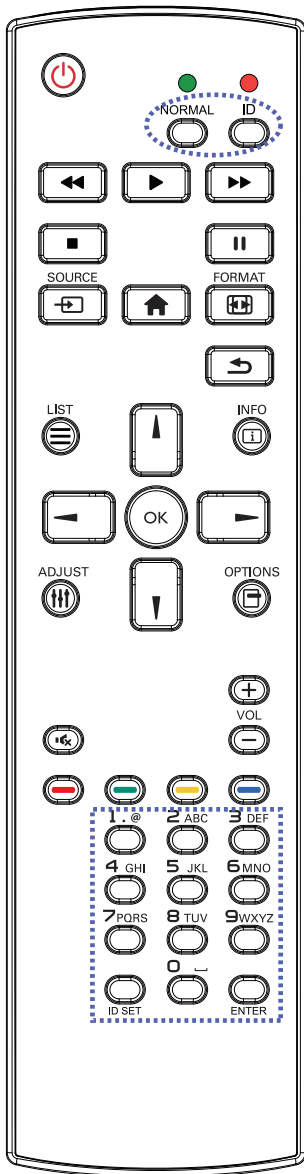

To set the remote control ID:

- 1 Press the **ID** button. The red LED blinks twice.
- 2 Press the **ID SET** button for more than 1 second to enter the ID mode. The red LED lights up. Press the **ID SET** button again will exit the ID mode. The red LED lights off.
- 3 Press the digit numbers [0] ~ [9] to select the display you want to control. For example:
 - Display ID #1: press [0], [1]
 - Display ID #11: press [1], [1]The numbers available are from [01] ~ [255].
 - Not pressing any button within 10 seconds will exit the ID mode.
 - If an error pressing of buttons other than the digits occurred, wait 1 second after the red LED lights off and then lights up again, then press the correct digits again.
- 4 Press the **ENTER** button to confirm. The red LED blinks twice and then lights off.

Note:

- ◆ Press the **NORMAL** button. The green LED blinks twice, indicating the remote control returns to normal operation.
- ◆ It is necessary to set up the Monitor ID for each display before selecting its ID number.

PRODUCT DESCRIPTION

1.7.3 Remote Control buttons on USB source

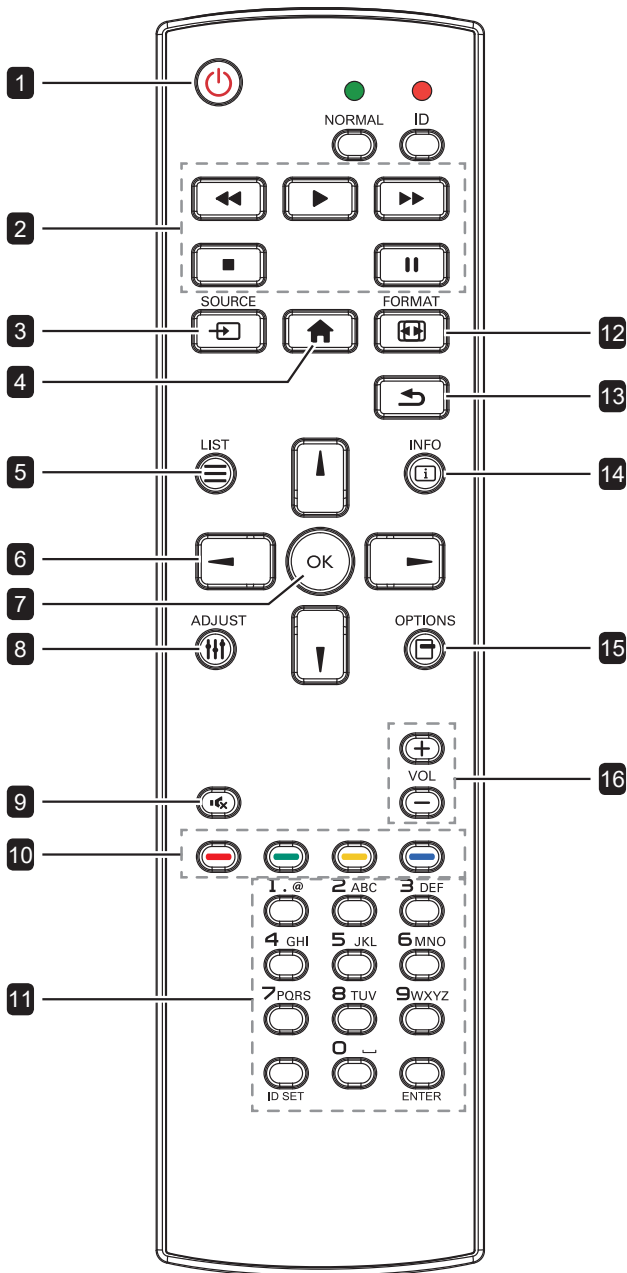

1 [POWER] POWER

Turn the display on or to put the display into standby mode.

The button is only controlled by Scalar.

2 [PLAY] PLAY

- Control playback of media (video/photo/music) files.

To play a media file, select **USB** >

Compose > edit or new add playlist >

choose media files > press the OK button to play all the media files in the playlist.

- When playing a video, press the ■ button to stop playing. Press the ► button, to replay the video from the beginning.

- When playing a video or displaying a slideshow, press the || button to pause playing.

- All media files should be put at the folder, which is named "agn" with sub-folder, under the root directory of the specified storage (internal/USB/SD Card). All sub-folders (video/photo/music) are named by media types and shouldn't be changed.

videos: {root dir of storage}/agn/video/

photos: {root dir of storage}/agn/photo/

music: {root dir of storage}/agn/music/

Note that the root directories of three storages are:

Internal storage: /sdcard

USB storage: /mnt/usb_storage

SD card: /mnt/external_sd

3 [SOURCE] SOURCE

Choose **USB** as the input source.

The button is only controlled by Scalar.

4 [HOME] HOME

Access the OSD menu.

The button is only controlled by Scalar.

5 [LIST] LIST

Move the focus up to the next control or widget such as buttons.

6 [NAVIGATION] NAVIGATION buttons

Navigate through menus and choose items.

7 [OK] OK

Confirm an entry or selection.

8 [ADJUST] ADJUST

Move the focus down to the next control or widget such as buttons.

PRODUCT DESCRIPTION

9 MUTE

Turn the mute function on/off.

The button is only controlled by Scalar.

10 COLOR

No function. These two buttons are only controlled by Scalar.

11 [Number/ ID SET/ ENTER]

ID SET/ENTER: No function. These two buttons are only controlled by Scalar.

12 FORMAT

Change the aspect ratio.

The button is only controlled by Scalar.

13 BACK

Return to the previous menu or exit from the previous function.

14 INFO

- Display information about current input signal. It is shown by Scalar.
- **USB > Compose** > edit or new add playlist > choose any media files > press the  button to show the information of the chosen media file.

15 OPTIONS

Open toolbar.

- **USB > Compose** > edit or new add playlist > press the  button to open toolbar. Toolbar opens on the left side of the screen.

16 VOLUME

Adjust the volume level. The buttons are only controlled by Scalar.

PRODUCT DESCRIPTION

1.7.4 Inserting the Batteries in the Remote Control

The remote control is powered by two 1.5V AAA batteries.

To install or replace batteries:

- 1 Press and then slide the cover to open it.
- 2 Align the batteries according to the (+) and (-) indications inside the battery compartment.
- 3 Replace the cover.

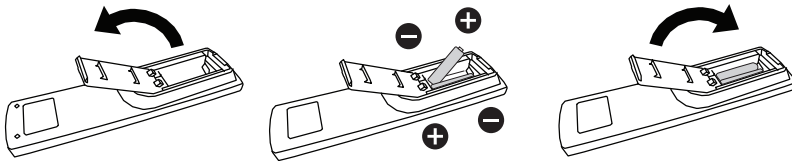

1.7.5 Handling the Remote Control

- Do not subject to strong shock.
- Do not allow water or other liquid to splash the remote control. If the remote control gets wet, wipe it dry immediately.
- Avoid exposure to heat and steam.
- Other than to install the batteries, do not open the remote control.

1.7.6 Operating Range of the Remote Control

Point the top of the remote control toward the display's remote control sensor when pressing a button.

When using the remote control, the distance from the remote control to the sensor on the display should be less than 5m/16ft, and the horizontal and vertical angles should be less than 30°.

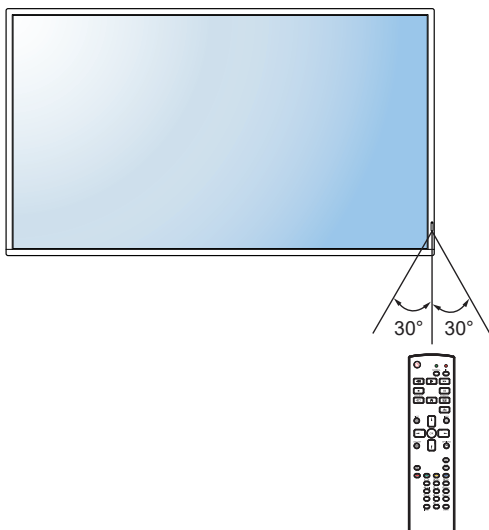

Caution:

The incorrect use of batteries can result in leaks or bursting. Be sure to follow these instructions:

- ◆ Place “AAA” batteries matching the (+) and (-) signs on each battery to the (+) and (-) signs of the battery compartment.
- ◆ Do not mix battery types.
- ◆ Do not combine new batteries with used ones. It causes shorter life or leakage of batteries.
- ◆ Remove the dead batteries immediately to prevent them from liquid leaking in the battery compartment. Don't touch exposed battery acid, as it can damage your skin.

Note:

- ◆ If you do not intend to use the remote control for a long period, remove the batteries.
- ◆ The remote control may not function properly when the remote control sensor on this display is under direct sunlight or strong illumination, or when there is an obstacle in the path of signal transmission.

CHAPTER 2: MAKING CONNECTIONS

2.1 Connecting the Power

- 1 Connect one end of the power cord to the AC IN connector at the rear of the LCD display.
- 2 Connect the other end of the power cord to a power outlet or a power supply.
- 3 Set the **Main Power** switch to ON.

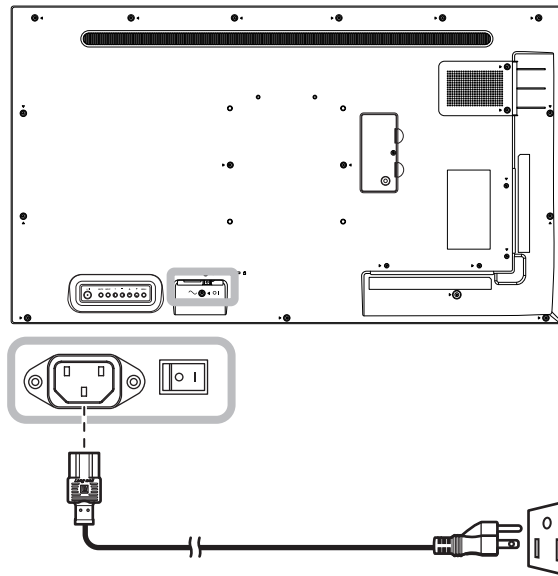

⚠ Caution:

- ◆ Make sure that the LCD display is not connected to the power outlet before making any connections. Connecting cables while the power is ON may cause electric shock or personal injury.
- ◆ When unplugging the power cord, hold the power cord by the plug head. Never pull by the cord.

MAKING CONNECTIONS

2.2 Connecting a Computer

2.2.1 Using DVI-I Input

Connect one end of a DVI cable to the DVI-I IN connector of the LCD display and the other end of a DVI cable to the DVI connector of the computer.

For VGA input, connect one end of a DVI-I to VGA cable to the DVI-I IN connector of the LCD display and the other end of a DVI-I to VGA cable to the VGA connector of the computer.

For audio input, connect one end of an audio cable to the AUDIO IN connector of the LCD display and the other end of an audio cable to the AUDIO OUT connector of the computer.

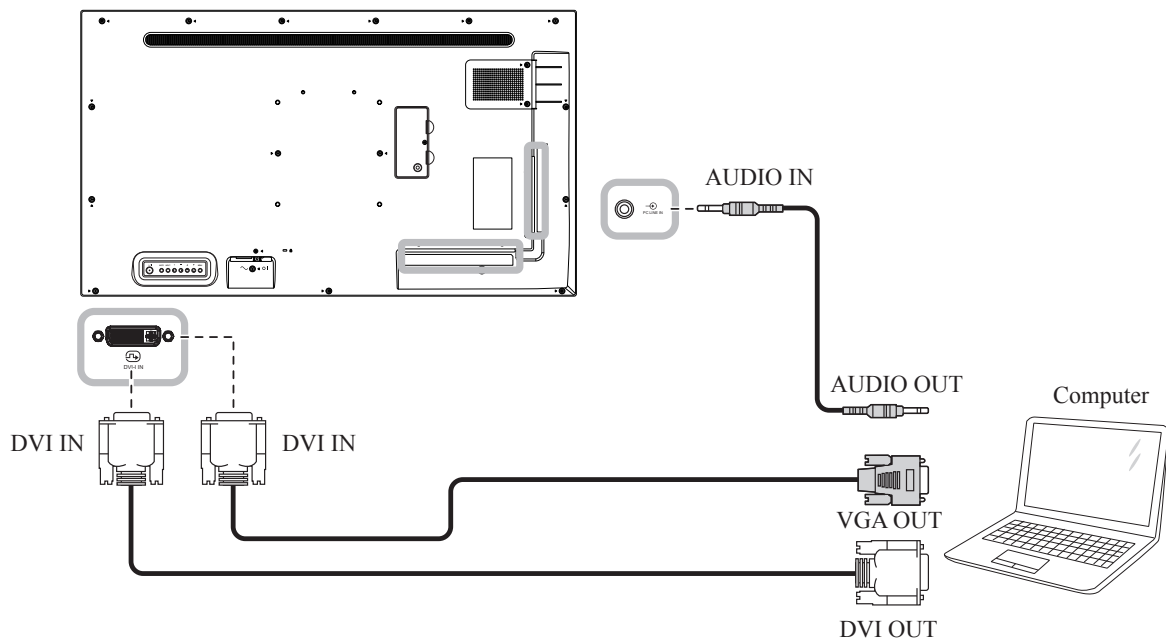

MAKING CONNECTIONS

2.2.2 Using DisplayPort Input

Connect one end of a DisplayPort cable to the DP IN connector of the LCD display and the other end of a DisplayPort cable to the DP (DisplayPort) OUT connector of the computer.

For a daisy-chain configuration connection, connect one end of a DisplayPort cable to the DP OUT connector of the DISPLAY 1 and the other end of a DisplayPort cable to the DP IN connector of the DISPLAY 2.

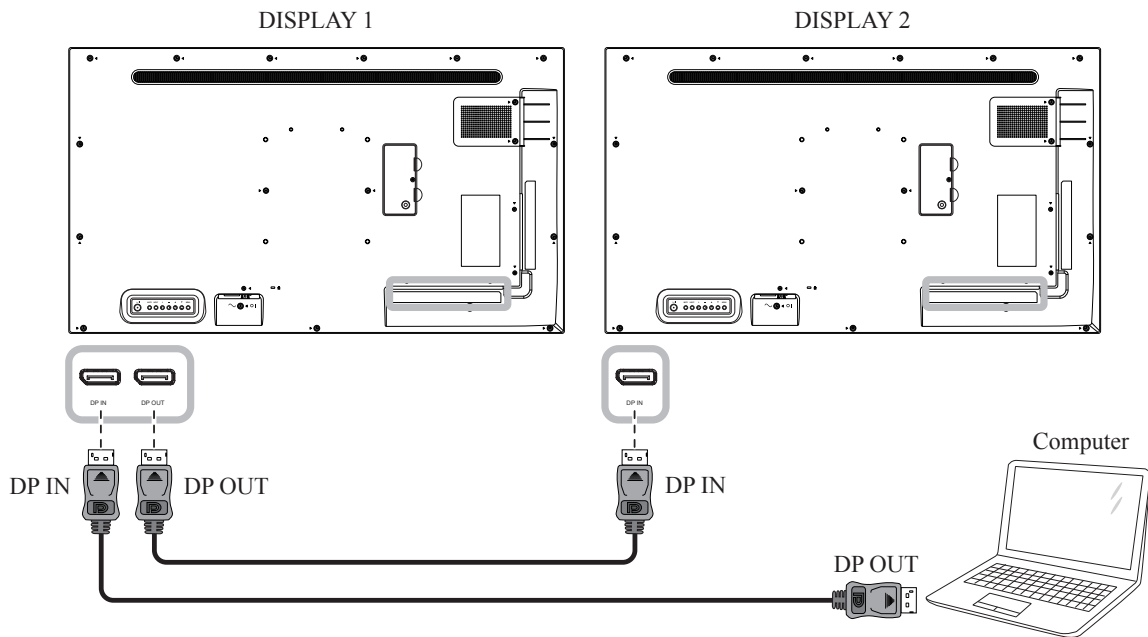

2.2.3 Using HDMI Input

Connect one end of an HDMI cable to the HDMI IN connector of the LCD display and the other end of an HDMI cable to the HDMI OUT connector of the computer.

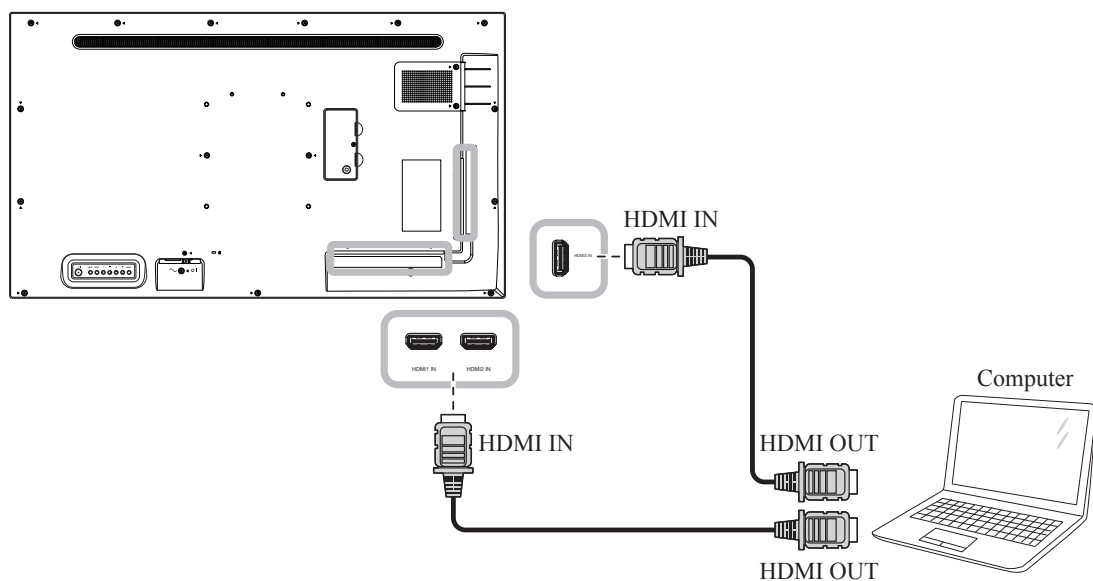

MAKING CONNECTIONS

2.3 Connecting External Equipment (Video Player)

2.3.1 Using HDMI Video Input

Connect one end of an HDMI cable to the HDMI IN connector of the LCD display and the other end of an HDMI cable to the HDMI OUT connector of the video player.

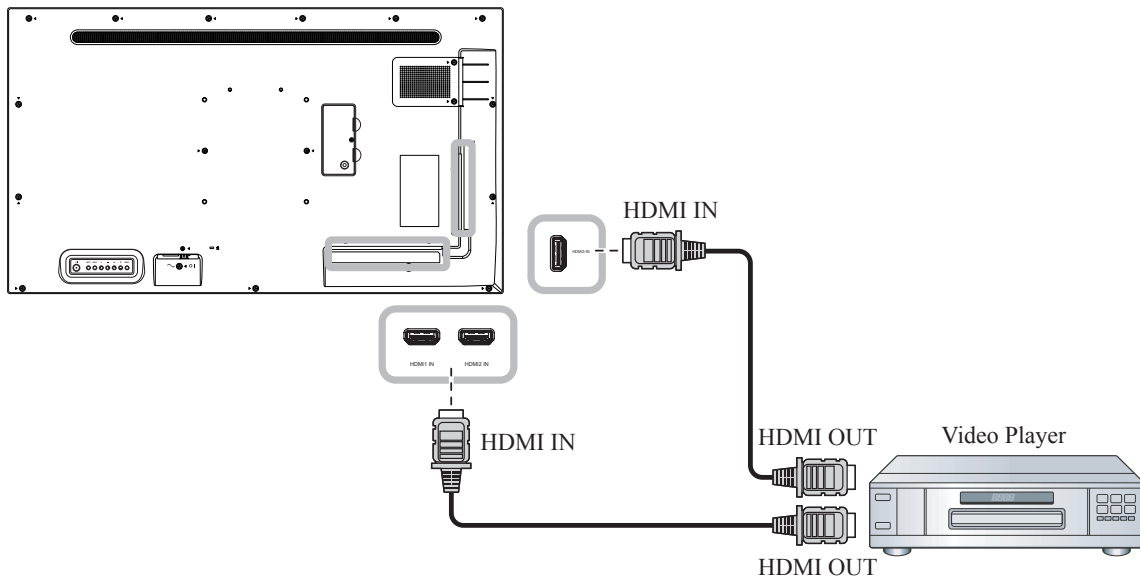

MAKING CONNECTIONS

2.4 Connecting Audio Equipment

2.4.1 Connecting an External Audio Device

Connect one end of an audio cable to the AUDIO OUT connectors of the LCD display and the other end of an audio cable to the AUDIO IN connectors of the audio device.

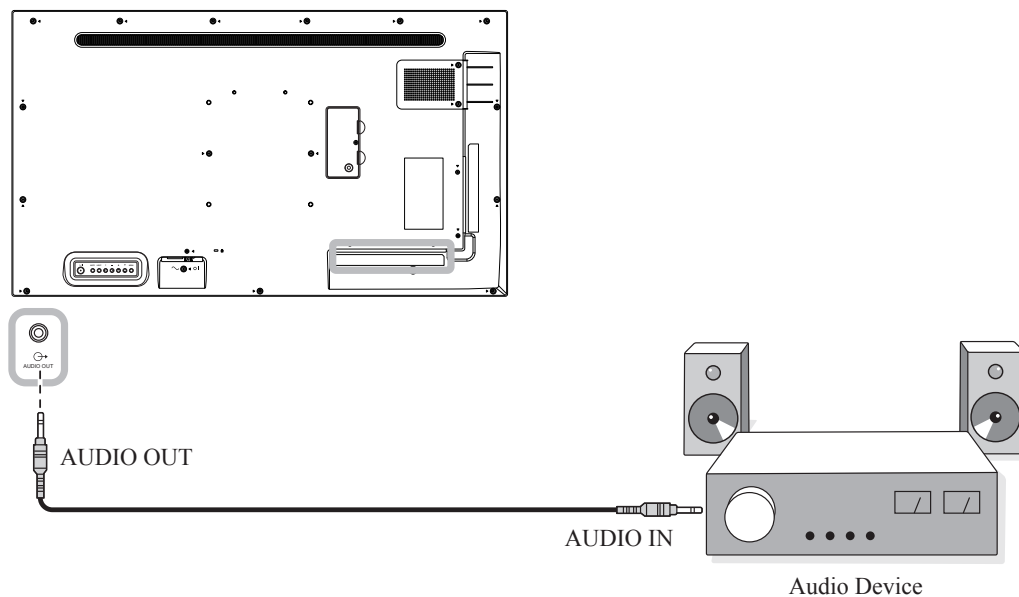

Note:

- ◆ Make sure to select the correct audio input source. For more information, refer to page 56.

2.5 Using the Card Reader

Insert a micro SD card into the slot.

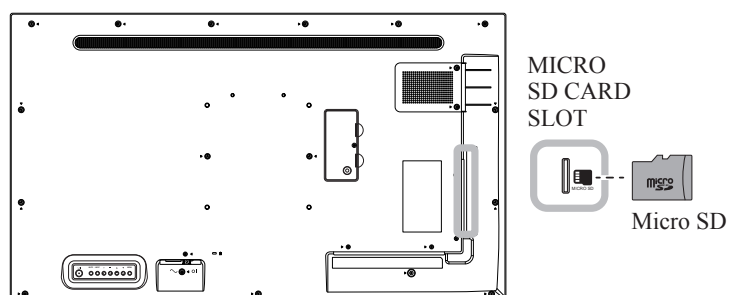

MAKING CONNECTIONS

2.6 Connecting Multiple Displays in a Daisy-chain Configuration

You can interconnect multiple displays to create a daisy-chain configuration for applications such as a video wall.

Caution:

To avoid unnecessary strain on the bezel, it is highly recommended to keep a minimum space of 0.5mm in which a business card is able to slip between all displays on all sides.

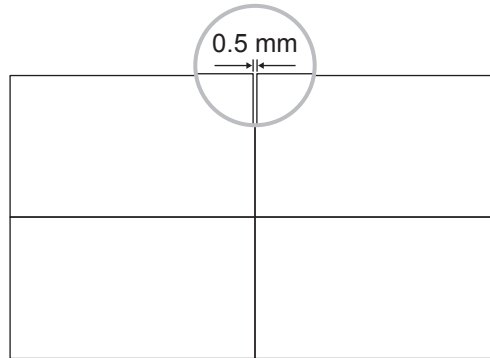

2.6.1 Display Control Connection

Connect the RS232 OUT connector of DISPLAY 1 to the RS232 IN connector of DISPLAY 2.

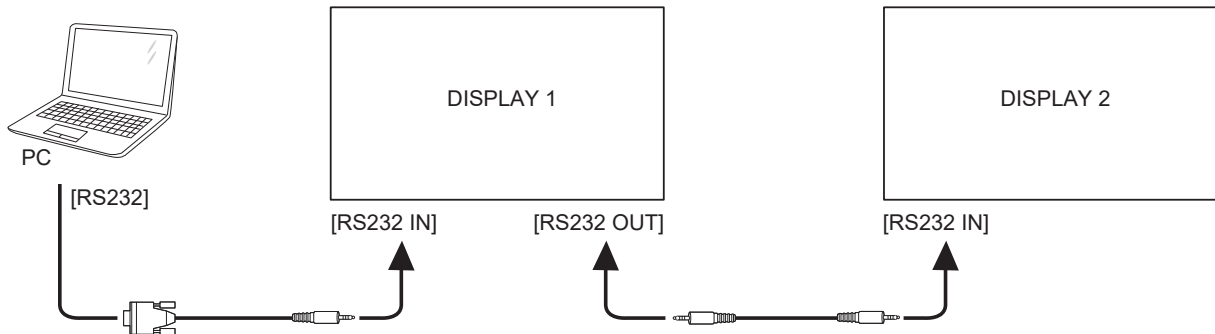

MAKING CONNECTIONS

2.7 IR Connection

Connect the IR sensor cable to the IR IN connector of the LCD display.

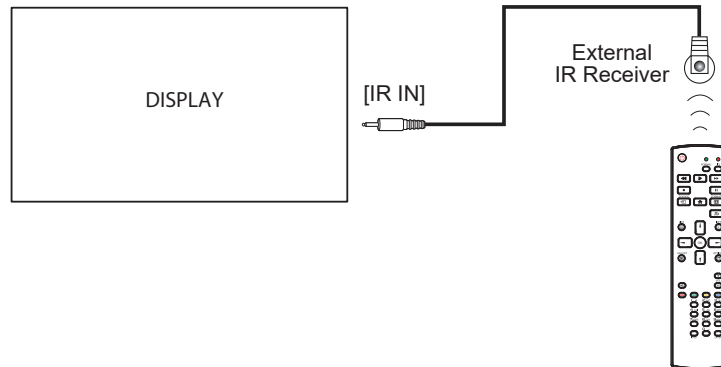

Note:

- ◆ This display's remote control sensor will stop working if the [IR IN] is connected.
- ◆ IR loop through connection can support up to 9 displays.
- ◆ IR in daisy chain via RS232 connection can support up to 9 displays.

2.8 IR Pass-Through Connection

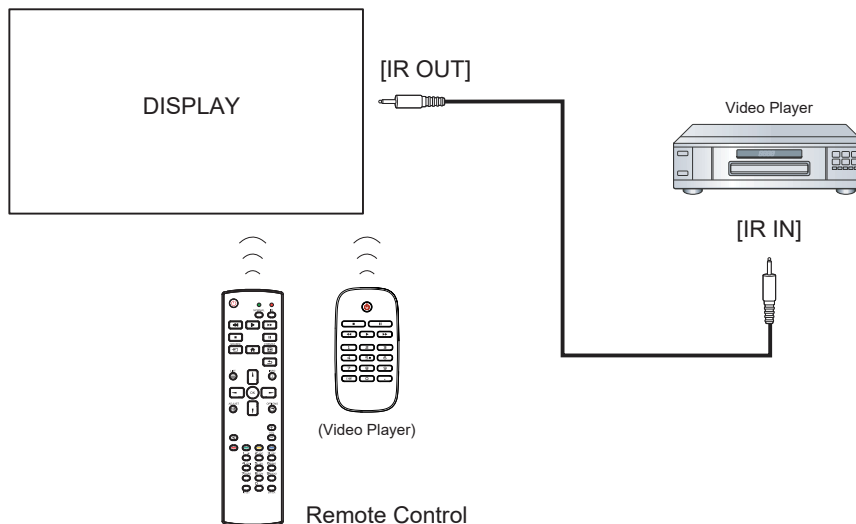

Connect one end of an IR extender cable to the IR OUT connector of the LCD display and the other end of an IR extender cable to the IR IN connector of the video player.

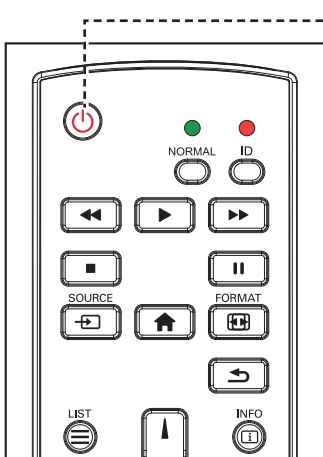

CHAPTER 3: USING THE LCD DISPLAY

3.1 Turning on the Power



- 1 Plug the power cord to a power outlet or power supply.
- 2 Press the  button to turn the LCD display on.
When the LCD display is turned on, press the  button to turn off the LCD display.

Note:

- ◆ The LCD display still consumes power as long as the power cord is connected to the power outlet. Disconnect the power cord to completely cut off power.

3.1.1 Initial Setup

After you turn on the LCD display, a *Welcome* screen opens. Then do the following:

- 1 Select the default OSD language.

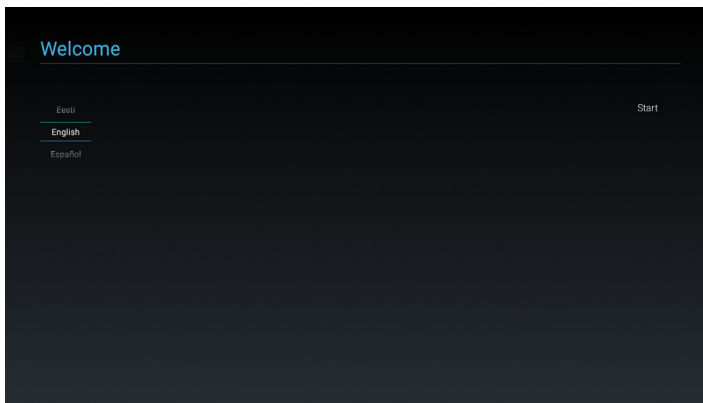

- 2 Select the method to perform the initial setup. Then select **Next** to continue.

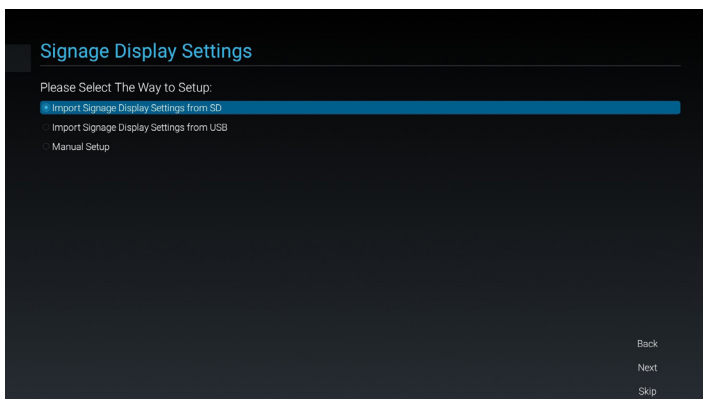

USING THE LCD DISPLAY

- 3 Enter the display name. Then select **Next** to continue.

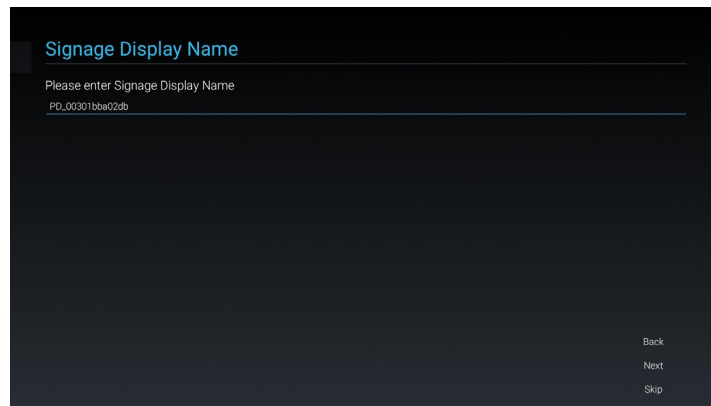

- 4 Configure network settings. Then select **Next** to continue.

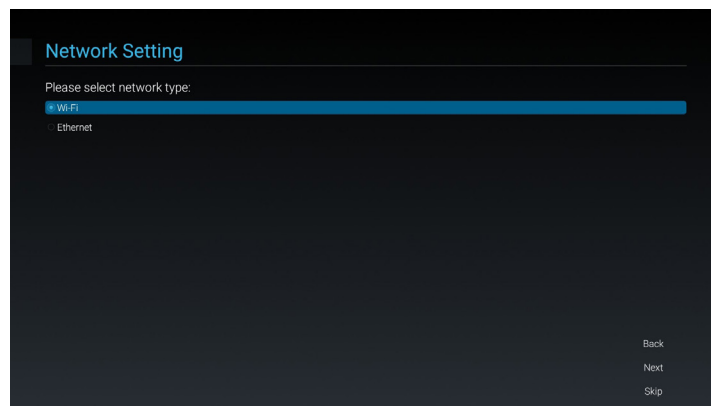

- 5 Select the clone source. Then select **Next** to continue.

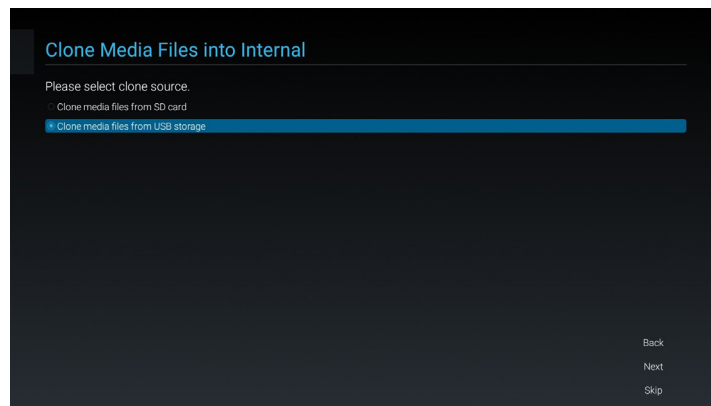



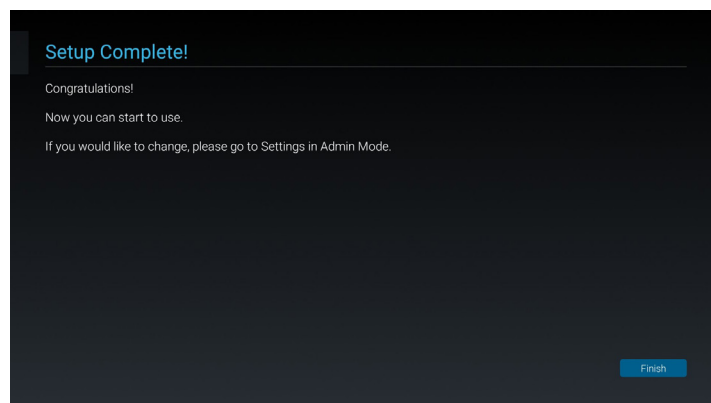

- 6 When the initial setup is complete, a *Setup Complete!* screen appears. Then click **Finish**.

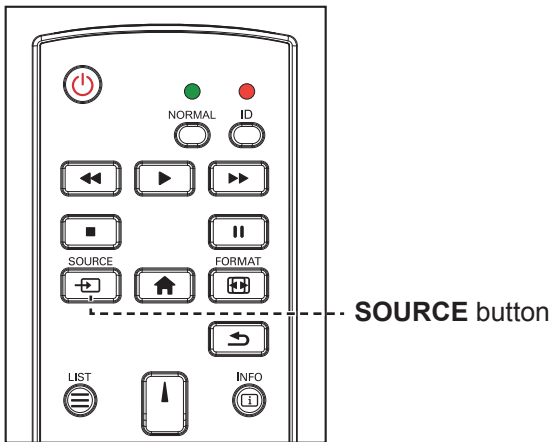

USING THE LCD DISPLAY

3.2 Selecting the Input Source Signal



- 1 Press the  button.
- 2 Press the  or  button to choose a device, then press the OK button.

Note:

- ◆ After pressing the  button, a menu with available input sources will be displayed on the screen.

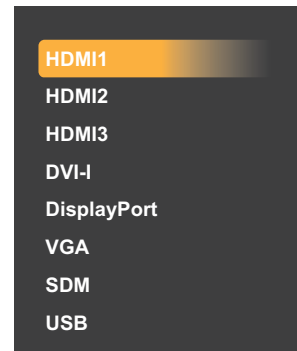

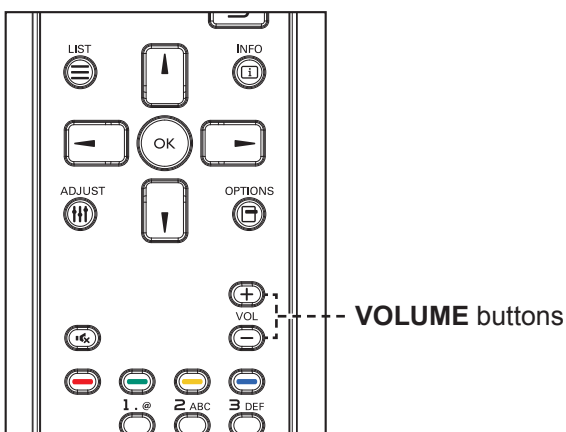

- ◆ If the selected input source signal is not connected to the LCD display or is turned off, the screen will display multi-color screen.

3.3 Adjusting the Volume



Press the  or  button to adjust the volume.

Note:

- ◆ After pressing the  or  button, the volume icon is displayed on the screen automatically.



- ◆ Press the  button to mute the audio.

USING THE LCD DISPLAY

3.4 Changing the Picture Format

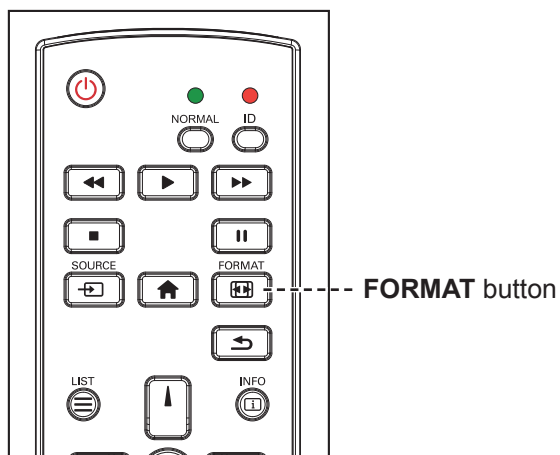

Press the  button repeatedly to change the picture format.

Note:

The available picture formats include:

- ◆ **Full:** Restores the correct proportions of pictures transmitted in 16:9 using the full screen display.
- ◆ **4:3:** The picture is reproduced in 4:3 format and a black band is displayed on either side of the picture.
- ◆ **Real:** This mode displays the image pixel-by-pixel on screen without scaling the original image size.
- ◆ **21:9:** The picture is reproduced in 21:9 format and a black band at the top and bottom.
- ◆ **Custom:** Choose to apply the custom zoom settings set in the **Screen > Custom zoom** submenu.

CHAPTER 4: USB SOURCE

4.1 Accessing the USB Menu



Note:

- ◆ The control buttons described in this section are on the remote control.
- ◆ Press the  button once in any menu to return to the previous menu or repeatedly to return to the Hint screen as illustrated below.

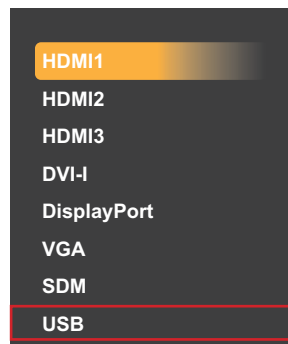

To access the USB source, do the following:



- 1 Press the  button to open a list of input sources.
- 2 Press the  or  button to select **USB** source from the list.
- 3 Press the **OK** button on the remote control to open the item.

USB SOURCE

4.2 Using the USB Menu

Use the USB source to play your favorite photo, video, and music files. The files can be grouped into playlists from various storage devices, such as internal storage, USB storage, and SD card. The total number of playlists can be up to seven but the media content of a single playlist is not limited.

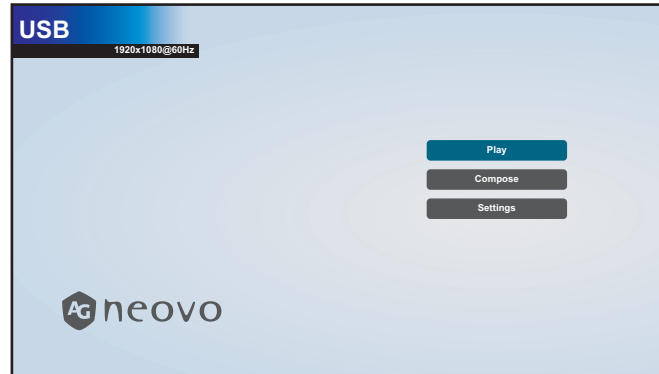

4.2.1 Creating a Playlist

To create a playlist, do the following:

- 1 Copy your photo, video, and/or music files on the storage device to the following paths respectfully:
 - Photo: {root dir of storage}/agn/photo/
 - Video: {root dir of storage}/agn/video/
 - Music: {root dir of storage}/agn/music/

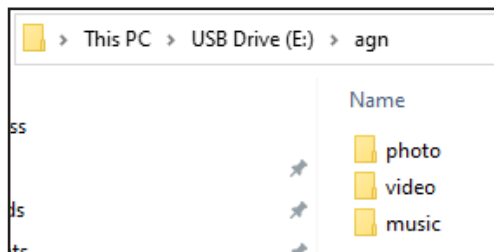

Note:

- ◆ Music files can be selected and used as background music for a slideshow.
- 2 Connect the storage device to the LCD monitor (if necessary).
 - 3 Set the input source to **USB**. See “4.1 Accessing the USB Menu”.
 - 4 Press the **▲** or **▼** button to select the **Compose** tab and then press the **OK** button to open the PlayList menu.

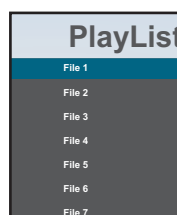

- 5 Press the **▲** or **▼** button to select a file among **File 1** to **File 7** where you want to add your media files and then press the **OK** button.

USB SOURCE

- Press the ◀ or ▶ button to select a storage device where are saved your media files and then press the OK button.

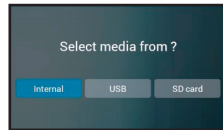

Note:

- ◆ Press the OK button again if prompted to confirm the path.

A file browser opens where your media files on the storage device are displayed in the Source column and the content of the playlist is displayed in the Playlist column.

- Press the ▲ or ▼ button to select the **Photo** or **Video** folder and then press the OK button. The folder content is displayed in the Source column.

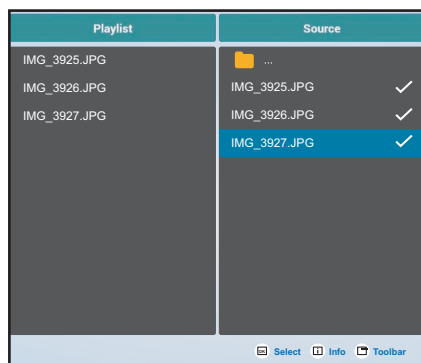

- Press the ▲ or ▼ button to select a media file for reviewing (if necessary). Press any of the following buttons:

— **OK Select**: To select a single file. Press the OK button again to deselect the file.

— **Info**: To preview the media file.

- Press the **Option** button to start adding or modifying the playlist.

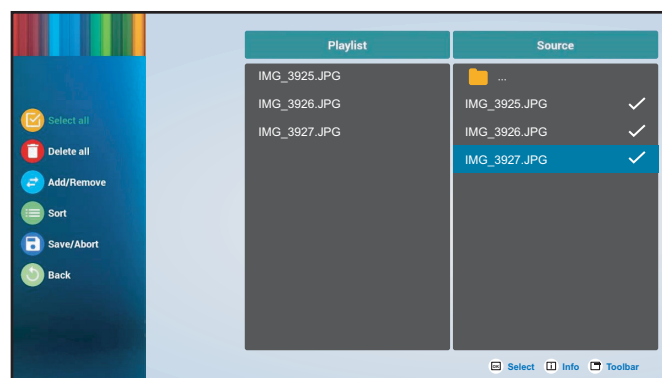

Then press the ▲ or ▼ button and press the OK button to select any of the following actions:

— **Select all**: Select all the visible media files on the source.

— **Delete all**: Delete all the media files in the playlist.

— **Add/Remove**: Add or remove the selected files from the playlist created on the source.

USB SOURCE

- **Sort:** Sort the media files in the playlist one by one. The Sort menu opens.
 - a) Press the ▲ or ▼ button and then press the OK button to select the file. Next to the selected file appears ↕ icon.
 - b) Press the ▲ or ▼ button to adjust the file order in the Slideshow.
 - **Save/Abort:** Save the playlist or discard the modifications. Press the ◀ or ▶ button to select **Save** or **Abort** and then press the OK button to confirm. If you have added only photos to the playlist, you are prompted to add background music to the slideshow. Press the ▲ or ▼ button to select **Yes** or **No** and press the OK button to confirm. If you decide to add background music to the slideshow, you are prompted to select a music file from the Music folder.
 - **Back:** Close the toolbar.
- 10 Repeat steps 1 to 9 for creating more playlists.

4.2.2 Modifying a Playlist

To modify a playlist, do the following:

- 1 Set the input source to **USB**. Refer to “4.1 Accessing the USB Menu”.
- 2 Press the ▲ or ▼ button to select the **Compose** tab and then press the OK button to open the PlayList menu.
- 3 Press the ▲ or ▼ button to select the playlist that you want to modify and then press the OK button.

Note:

- ◆ You can modify only playlists that have the ↕ icon next to the **File #**, where “#” is the file number.

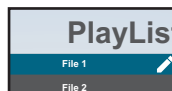

Those playlists that do not have the ↕ icon are empty.

- 4 Press the ◀ or ▶ button to select **Edit** or **Delete** the playlist and then press the OK button to confirm.
- 5 Perform any of the modifications as described in steps 7 to 9 in “4.2.1 Creating a Playlist” section.

USB SOURCE

4.2.3 Playing Files in a Playlist

To play files in a playlist, do the following:

- 1 Set the input source to **USB**. See “4.1 Accessing the USB Menu”.
- 2 Press the **▲** or **▼** button to select the **Play** tab and then press the **OK** button to open the PlayList menu.
- 3 Press the **▲** or **▼** button to select the playlist that you want to play and then press the **OK** button.

Note:

- ◆ You can play only playlists that have the  icon next to the **File #**, where “#” is the file number.

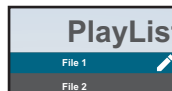

Those playlists that do not have the  icon are empty.

4.2.4 USB Menu Settings

To configure USB menu settings, do the following:

- 1 Set the input source to **USB**. See “4.1 Accessing the USB Menu”.
- 2 Press the **▲** or **▼** button to select the **Settings** tab and then press the **OK** button to open the Settings menu.
- 3 Press the **▲** or **▼** button to select any of the menu items and then press the **OK** button to enter its configuration menu:
 - **Repeat Mode**: Press the **▲** or **▼** button to set the playlist repeat mode to **Repeat once** or **Repeat all** and then press the **OK** button to save the setting.
 - **Slideshow Effect**: Press the **▲** or **▼** button to set the slideshow effect to **Right to left**, **Fold**, **Corner**, or **None** and then press the **OK** button to save the setting.

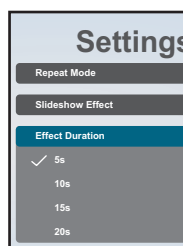

- **Effect Duration**: Press the **▲** or **▼** button to set the slideshow effect duration to **5s**, **10s**, **15s**, or **20s** and then press the **OK** button to save the setting.
- **Autoplay**: Press the **▲** or **▼** button to specify the menu (**Photo only**, **Video only**, or **Photo and Video**) for automatic slideshow and then press the **OK** button to save the setting.

Help:

- 1 Please put the photo or video files in the USB root path.
- 2 Click the checkbox to enable the Autoplay mode.
- 3 Choose a type you want to play.
- 4 Plug on USB and ensure that the MediaPlayer is opened.

USB SOURCE

- **Software decode:** Press the **▲** or **▼** button to enable or disable the software decode function and then press the **OK** button to save the setting.

4.3 Admin Mode

The Admin Mode enables you full access to the system configuration settings, applications, network configuration parameters, and storage.

The default Custom screen is empty to prevent unauthorized access to the system.



4.3.1 Entering the Admin Mode

To enter the Admin Mode, do the following:

- 1 Set the input source to **Custom**. See “4.1 Accessing the USB Menu”.
- 2 Enter the Admin Mode by pressing the **▲** button once followed by entering numbers “1”, “6”, “6”, and “8” on the remote control. The Admin Mode screen opens.

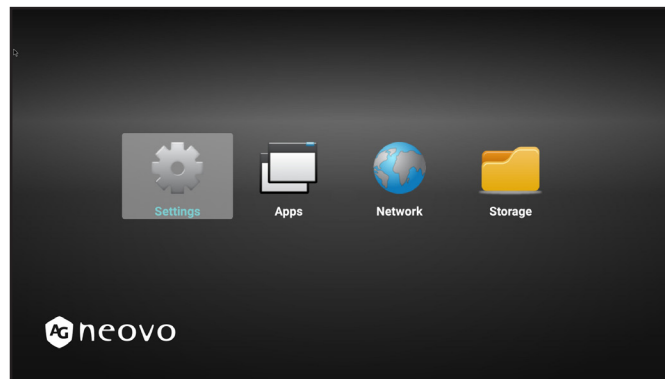

USB SOURCE

4.3.2 System Settings

To access the system settings, do the following:

- 1 Enter the Admin Mode. See “4.3.1 Entering the Admin Mode” on page 39.
- 2 Do any of the following to access the system settings:
 - Press the ◀ or ▶ button to select the **Settings** tab and then press the OK button.
 - Press the ▲ or ▼ button and then press the OK button to open **Apps** tab > **Settings**.

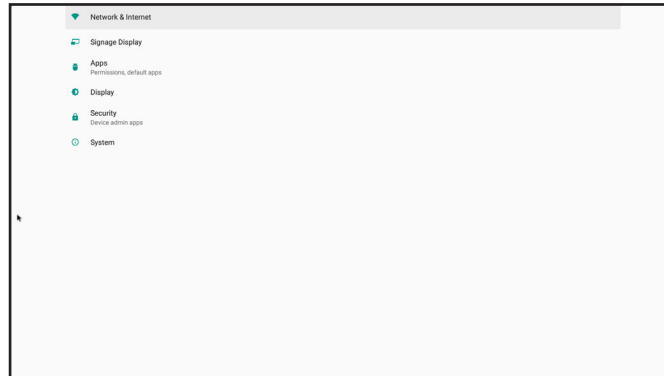

- 3 Modify any of the following settings:

Note:

- ◆ Use the ◀, ▶, ▲, ▼, and/or OK button on the remote control to select items and adjust settings. If you need to enter characters, the virtual keyboard opens automatically on the screen after you select the item.
 - **Network & Internet > Ethernet > Ethernet**: Enable or disable configuring Ethernet settings.
 - **Network & Internet > Ethernet > Ethernet Configuration**: Review MAC address and configure the network connection settings, such as **Connection Type** (DHCP or static IP), **IP Address**, **Netmask**, **DNS Address**, and **Gateway**.
 - **Signage Display > General settings > Signage Display Name**: Review or modify the signage display name if necessary.
 - **Signage Display > General settings > Boot Logo**: Set boot animation. The system checks for the “boot animation.zip” file from the connected USB storage or SD card.

USB SOURCE

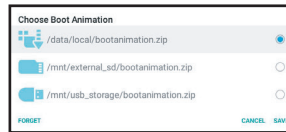

- **Display > Font size:** Set the font size to **Small**, **Default**, **Large**, or **Largest**.
- **Signage Display > System Tools > Clear storage:** Clear data on **All** storage devices, **Internal storage**, **USB storage**, or **SD card**.
- **Signage Display > System Tools > Reset:** Perform **Factory Reset** to reset all system settings to the factory defaults.
- **Signage Display > System Tools > Import & Export:** **Export Signage Display Settings** or **Import Signage Display Settings** to a specified storage device.
- **Signage Display > System Tools > Clone > Clone Media Files > Clone Source:** Select a storage device among **Internal storage**, **SD card**, and **USB storage** for cloning.
- **Signage Display > System Tools > Clone > Clone Media Files > Target Location:** Set the storage device among **Internal storage**, **SD card**, and **USB storage** as a target location for cloning.

4.3.3 Accessing Network Settings in Admin Mode

To access network configuration settings in Admin Mode, do the following:

- 1 Enter the Admin Mode. See “4.3.1 Entering the Admin Mode” on page 39.
- 2 Do any of the following to access the network settings:
 - Press the ◀ or ▶ button and then press the OK button to select the **Settings** tab > **Network & Internet** > **Ethernet** > **Ethernet Configuration**.
 - Press the ◀ or ▶ button to select **Network** tab and then press the OK button.

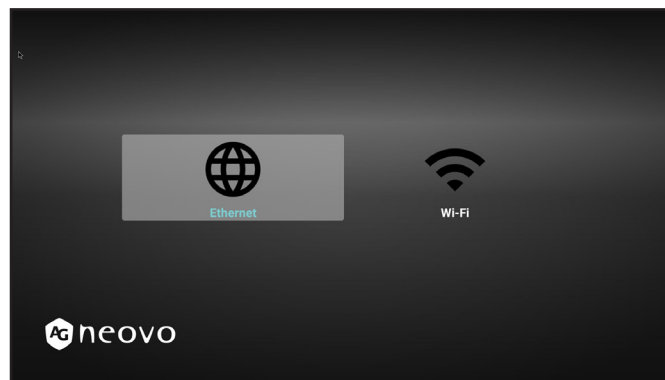

- 3 Press the ◀ or ▶ button to select the **Wi-Fi** tab or the **Ethernet** tab and then press the OK button to start configuring the connection settings.

Note:

- ◆ The Wi-Fi configuration settings are visible only if you have connected a Wi-Fi dongle to the LCD display.

USB SOURCE

4.3.4 Managing Storage in Admin Mode

To access and manage storage in Admin Mode, do the following:

- 1 Enter the Admin Mode. See “4.3.1 Entering the Admin Mode” on page 39.
- 2 Do any of the following to access the storage:
 - Press the ◀ or ▶ button to select **Storage** tab and then press the OK button.
 - Press the ◀ or ▶ button and then press the OK button to select **Apps** tab > **File Manager**.
- 3 Press the ◀ or ▶ button to select the internal storage or any connected external storages, such as USB storage or SD card.

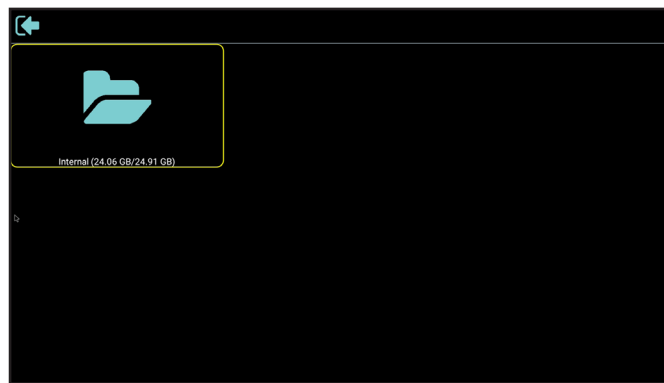

- 4 Press the ▲ or ▼ button to select the desired file and then press the OK button. A pop-up menu opens.
- 5 Press the ▲ or ▼ button and then the OK button to do any of the following:
 - **Open**: Open the file on the screen.
 - **Delete**: Delete the file.
 - **Copy**: Press the ▲ or ▼ button and select the destination storage device where you want to copy the file. Then press the OK button to complete the procedure.
 - **Move**: Press the ▲ or ▼ button and select the destination storage device where you want to move the file. Then press the OK button to complete the procedure.
 - **Select**: Enter the file Select Mode. Press the ▲ or ▼ button and then press the OK button to select file(s). After the file selection is done, press the OK button. Then press the ▲ or ▼ button to select an action from the pop-up menu among **Delete Selection**, **Copy Selection**, **Move Selection**, **Unselect**, and **Unselect All**. Press the OK button to complete the procedure.

CHAPTER 5: ON SCREEN DISPLAY MENU

5.1 Using the OSD Menu

#	Menu Navigation	Operation	
		Control Panel	Remote Control
1	Display the main menu screen. 	Press the MENU button.	Press the ⬆ button.
2	Enter the submenu.  <p>The highlighted item (orange) indicates the active submenu.</p>	1 Press the ▲ or ▼ button to select the menu item. 2 Press the + button to enter the submenu.	1 Press the ▲ or ▼ button to select the menu item. 2 Press the OK or ➡ button to enter the submenu.
3	Adjust the settings. For example: 	1 Press the ▲ or ▼ button to select the submenu item. 2 Press the + button to open the submenu item. 3 Press the ▲ or ▼ button to adjust the value of the menu item.	1 Press the ▲ or ▼ button to select the submenu item. 2 Press the OK button to open the submenu item. 3 Press the ← or → button to adjust the value of the menu item.
4	Exit the submenu.	Press the MENU or — button to return to the previous menu.	Press the OK or ↶ button to return to the previous menu.

ON SCREEN DISPLAY MENU

#	Menu Navigation	Operation	
		Control Panel	Remote Control
5	Close the OSD window.	Press the MENU button or — button several times.	Press the ⬆ button or the ↶ button several times.

When settings are modified, all changes are saved when the user does the following:

- Proceeds to the another menu.
- Exits the OSD menu.
- Waits for the OSD menu to disappear.

Note:

- ◆ Availability of some menu items depend on the input source signal. If the menu is not available, it is disabled and grayed out.

ON SCREEN DISPLAY MENU

5.2 OSD Menu Tree

1	Picture	Brightness	90
2	Screen	Contrast	50
3	Audio	Sharpness	20
4	Configuration 1	Black level	50
5	Configuration 2	Tint	50
6	Advanced option	Color	55
		Noise reduction	Off
		Gamma selection	Native
		Color temperature	Native
		Color control	Action
		Smart power	Off
		Overscan	Off

Main Menu	Submenu	Remarks
1. Picture	<ul style="list-style-type: none"> • Brightness • Contrast • Sharpness • Black level • Tint • Color • Noise reduction • Gamma selection • Color temperature • Color control • Smart power • Overscan • Picture reset 	See page 48.
2. Screen	<ul style="list-style-type: none"> • H position • V position • Clock • Clock phase • Zoom mode • Custom zoom • Auto adjust • Screen reset 	See page 52.

ON SCREEN DISPLAY MENU

Main Menu	Submenu	Remarks
3. Audio	<ul style="list-style-type: none"> • Balance • Treble • Bass • Volume • Audio out (line out) • Maximum volume • Minimum volume • Mute • Audio source • Audio reset • Audio Out Sync • Speaker Setting 	See page 55.
4. Configuration1	<ul style="list-style-type: none"> • Switch on state • Panel saving • RS232 routing • Boot on source • WOL • Configuration1 reset • Factory reset 	See page 57.
5. Configuration2	<ul style="list-style-type: none"> • OSD turn off • OSD H position • OSD V position • System rotation • Information OSD • Logo • Monitor ID • Heat status • Monitor information • DP version • HDMI Version • Configuration2 reset 	See page 61.

ON SCREEN DISPLAY MENU

Main Menu	Submenu	Remarks
6. Advanced option	<ul style="list-style-type: none">• IR control• Power LED light• Keyboard control• Uniwall• Off timer• Date and time• Schedule• Alink• Auto signal detection• Language• OSD transparency• Standby• SDM settings• Advanced option reset	See page 64.

CHAPTER 6: ADJUSTING THE LCD DISPLAY



6.1 Picture Settings

Picture	Brightness	90
Screen	Contrast	50
Audio	Sharpness	20
Configuration 1	Black level	50
Configuration 2	Tint	50
Advanced option	Color	55
	Noise reduction	Off
	Gamma selection	Native
	Color temperature	Native
	Color control	Action
	Smart power	Off
	Overscan	Off

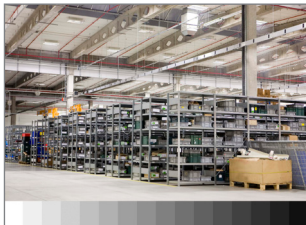
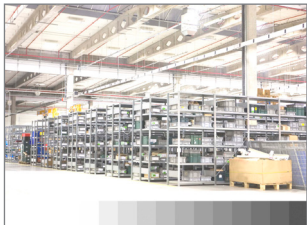
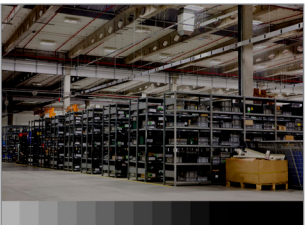
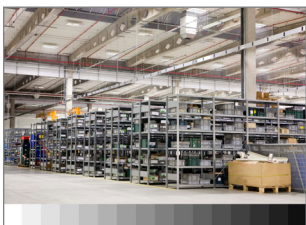
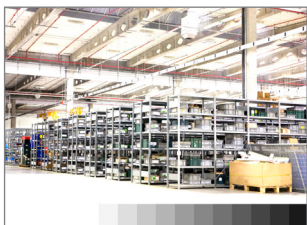
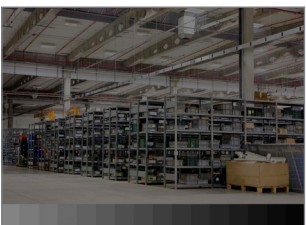
- 1 Press the **MENU** button on the control panel or the **⬆** button on the remote control to call out the OSD window.
- 2 Select **Picture**, then press the **+** button on the control panel or the **OK** button on the remote control.
- 3 Press the **▲/▼** button on the control panel or the **⬅/➡** button on the remote control to select an option.
- 4 Press the **+** button on the control panel or the **OK** button on the remote control to open the submenu item.

Item	Function	Operation	Range
Brightness	Adjust the luminance of the screen image.	Press the ▲/▼ button on the control panel or the ⬅/➡ button on the remote control to adjust the value.	0 to 100
	<i>Original Setting</i>	<i>High Setting</i>	<i>Low Setting</i>
			
Contrast	Adjust the difference between the black level and the white level. Note: This option is not available in USB mode.	Press the ▲/▼ button on the control panel or the ⬅/➡ button on the remote control to adjust the value.	0 to 100
	<i>Original Setting</i>	<i>High Setting</i>	<i>Low Setting</i>
			

ADJUSTING THE LCD DISPLAY

Item	Function	Operation	Range
Sharpness	Adjust the clarity and focus of the screen image. Note: This option is not available in USB mode.	Press the ▲/▼ button on the control panel or the ←/→ button on the remote control to adjust the value.	0 to 100
Black level	Adjust the black level of the screen image. Low brightness setting makes black colour darker. Note: This option is not available in USB mode.		0 to 100
Tint	Adjust the colour tint. Note: This option is not available in USB mode.		0 to 100
Color	Adjust the color saturation of the picture. Note: This option is not available in USB mode.		0 to 100
Noise reduction	Adjust the noise reduction to help remove noise from images. This helps produce clearer and crisper images. Note: This option is not available in USB mode.	<ol style="list-style-type: none"> 1 Press the ▲/▼ button on the control panel or the M button on the remote control to select the setting. 2 Press the + button on the control panel or the OK button on the remote control to set the value. 	Off Low Medium High
	<p style="text-align: center;">Noise Reduction Off</p> 		<p style="text-align: center;">Noise Reduction On</p> 

ADJUSTING THE LCD DISPLAY

Item	Function	Operation	Range
Gamma selection	<p>Adjust the non-linear setting for picture luminance and contrast.</p> <p>Note: This option is not available in USB mode.</p>	<ol style="list-style-type: none"> 1 Press the + button on the control panel or the OK button on the remote control to open the settings. 2 Press the ▲/▼ button on the control panel or the ↖/↗ button on the remote control to select the setting. 3 Repeat step 1 to set the setting. 4 Press the ↓ button and then the ←/→ button on the remote control to select CANCEL or OK. 5 Press the + button on the control panel or the OK button on the remote control to confirm the setting. 	<p>Native</p> <p>2.2</p> <p>2.4</p> <p>S gamma</p> <p>D-image</p>
Color temperature	<p>Select a color temperature for the image. A lower color temperature will have a reddish tint, whilst a higher color temperature gives off a more bluish tint.</p>	<ol style="list-style-type: none"> 1 Press the + button on the control panel or the OK button on the remote control to open the settings. 2 Press the ▲/▼ button on the control panel or the ↖/↗ button on the remote control to select the setting. 3 Repeat step 1 to set the setting. 4 Press the ↓ button and then the ←/→ button on the remote control to select CANCEL or OK. 5 Press the + button on the control panel or the OK button on the remote control to confirm the setting. 	<p>6500K</p> <p>7500K</p> <p>9300K</p> <p>10000K</p> <p>Native</p> <p>User 1</p> <p>User 2</p>

ADJUSTING THE LCD DISPLAY

Item	Function	Operation	Range
Color control	<p>Adjust the color tones of the image precisely by changing the User-R (Red), User-G (Green) and User-B (Blue) settings independently.</p> <p>Note:</p> <ul style="list-style-type: none"> Color control option becomes available if you set the Color temperature to User 1 or User 2. This option is not available in USB mode. 	<ol style="list-style-type: none"> Press the ▲/▼ button on the control panel or the M button on the remote control to select the setting. Press the + button on the control panel or the OK button on the remote control to set the value. Press the ▲/▼ button on the control panel or the ←/→ button on the remote control to adjust the value. 	<p>User-R (0-255) (User 1) User-G (0-255) (User 1) User-B (0-255) (User 1) 2000K - 10000K (User 2)</p>
Smart power	<p>Smart Power control is not relative to brightness control:</p> <ul style="list-style-type: none"> Initial setting Brightness <ul style="list-style-type: none"> » 80 (in the range from 0-100) » Power consumption 80% of maximum power consumption Smart Power <ul style="list-style-type: none"> » Off: No adaptation. » Medium: 70% of power consumption is relative to the current settings. » High: 55% of power consumption is relative to the current settings. 	<ol style="list-style-type: none"> Press the ▲/▼ button on the control panel or the M button on the remote control to select the setting. Press the + button on the control panel or the OK button on the remote control to set the value. 	<p>Off Medium High</p>
Overscan	<p>Change the display area of the image.</p> <ul style="list-style-type: none"> On: Display area is about 95%. Off: Display area is about 100%. <p>Note: This option is not available in USB mode.</p>	<ol style="list-style-type: none"> Press the ▲/▼ button on the control panel or the M button on the remote control to select the setting. Press the + button on the control panel or the OK button on the remote control to set the value. 	<p>Off On</p>

ADJUSTING THE LCD DISPLAY

Item	Function	Operation	Range
Picture reset	Reset all settings in the Picture menu to the factory preset values.	<ol style="list-style-type: none"> 1 Press the ▲/▼ button on the control panel or the ←/→ button on the remote control to select the setting. 2 Press the + button on the control panel or the OK button on the remote control to set the value. 	CANCEL RESET

6.2 Screen Settings

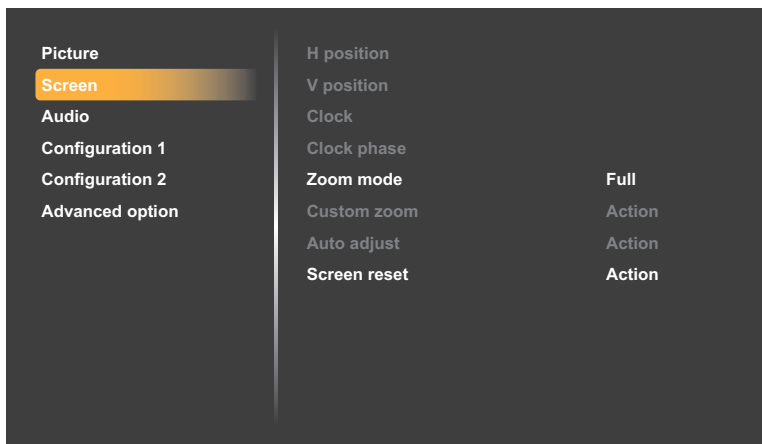

- 1 Press the **MENU** button on the control panel or the **⬆** button on the remote control to call out the OSD window.
- 2 Press the **▲/▼** button on the control panel or the **M** button on the remote control to select **Screen**. Then press the **+** button on the control panel or the **OK** button on the remote control.
- 3 Press the **▲/▼** button on the control panel or the **M** button on the remote control to select an option.
- 4 Press the **+** button on the control panel or the **OK** button on the remote control to open the submenu item.

Item	Function	Operation	Range
H position	Move the image to the right or to the left. Note: This option is available only if the input source is VGA.	Press the ▲/▼ button on the control panel or the ←/→ button on the remote control to adjust the value.	0 to 100
V position	Move the image up or down. Note: This option is available only if the input source is VGA.		0 to 100

ADJUSTING THE LCD DISPLAY

Item	Function	Operation	Range
Clock	Adjust the width of the image. Note: This option is available only if the input source is VGA.	Press the ▲/▼ button on the control panel or the ←/→ button on the remote control to adjust the value.	0 to 100
Clock phase	Adjust to improve the focus, clarity and stability of the image. Note: This option is available only if the input source is VGA.		0 to 100
Zoom mode	The pictures you receive may be transmitted in 16:9 format (wide screen) or 4:3 format (conventional screen). The 16:9 pictures sometimes have a black band at the top and bottom of the screen (letterbox format). Zoom mode will be deactivated when Anti-Burn-in™ is activated.	<ol style="list-style-type: none"> 1 Press the + button on the control panel or the OK button on the remote control to open the settings. 2 Press the ▲/▼ button on the control panel or the M button on the remote control to select the setting. 3 Repeat step 1 to set the setting. 4 Press the ▼ button on the control panel or the ↓ button on the remote control. Then press the ▲/▼ button on the control panel or the ←/→ button on the remote control to select CANCEL or OK. 5 Press the + button on the control panel or the OK button on the remote control to confirm the setting. 	<p>Full</p> <p>4:3</p> <p>Real</p> <p>21:9</p> <p>Custom</p>







ADJUSTING THE LCD DISPLAY



Item	Function	Operation	Range
Custom zoom	Use this function to further customize the zoom settings to suit the image you want to display. Note: Custom zoom option becomes available if you set the Zoom mode to Custom .		
	Zoom: Expand the horizontal and vertical sizes of the image simultaneously.	<ol style="list-style-type: none"> 1 Press the ▲/▼ button on the control panel or the M button on the remote control to select the setting. 2 Press the + button on the control panel or the OK button on the remote control to enter value adjustment menu. 3 Press the ▲/▼ button on the control panel or the ←/→ button on the remote control to adjust the value. 	Zoom H Zoom V Zoom H position V position 0 to 100
	H Zoom: Expand the horizontal size of the image only.		
	V Zoom: Expand the vertical size of the image only.		
	H position: Move the horizontal position of the image to the left or to the right.		
	V position: Move the vertical position of the image up or down.		
Auto adjust	Use this function to automatically optimize the display of VGA input image. Note: This option is available only if the input source is VGA.	<ol style="list-style-type: none"> 1 Press the ▲/▼ button on the control panel or the ←/→ button on the remote control to select the setting. 2 Press the + button on the control panel or the OK button on the remote control to set the value. 	CANCEL OK
Screen reset	Reset all settings in the Screen menu to the factory preset values.	<ol style="list-style-type: none"> 1 Press the ▲/▼ button on the control panel or the ←/→ button on the remote control to select the setting. 2 Press the + button on the control panel or the OK button on the remote control to set the value. 	CANCEL RESET

ADJUSTING THE LCD DISPLAY

6.3 Audio Settings

Picture	Balance	50
Screen	Treble	50
Audio	Bass	50
Configuration 1	Volume	20
Configuration 2	Audio out(line out)	20
Advanced option	Maximum volume	100
	Minimum volume	0
	Mute	Off
	Audio source	Digital
	Audio reset	Action
	Audio Out Sync	Off
	Speaker Setting	On

- 1 Press the **MENU** button on the control panel or the  button on the remote control to call out the OSD window.
- 2 Press the  button on the control panel or the  button on the remote control to select **Audio**. Then press the  button on the control panel or the **OK** button on the remote control.
- 3 Press the  button on the control panel or the  button on the remote control to select an option.
- 4 Press the  button on the control panel or the **OK** button on the remote control to open the submenu item.

Item	Function	Operation	Range
Balance	Adjust to emphasize the left or right audio output balance.	Press the  button on the control panel or the  button on the remote control to adjust the value.	0 to 100
Treble	Adjust to increase or decrease the higher-pitched sounds.		0 to 100
Bass	Adjust to increase or decrease the lower-pitched sounds.		0 to 100
Volume	Adjust to increase or decrease the audio output level.		0 to 100
Audio out (line out)	Adjust to increase or decrease line out output level.		0 to 100
Maximum volume	Adjust your own limitation for the maximum volume setting. This stops the volume from being playing too loud.		0 to 100
Minimum volume	Adjust your own limitation for the minimum volume setting.		0 to 100
Mute	Turn the mute function on/off.	Press the MUTE button on the control panel or the  button on the remote control to set the value.	Off On

ADJUSTING THE LCD DISPLAY

Item	Function	Operation	Range
Audio source	Select the audio input source. Without video signal there is no audio output. <ul style="list-style-type: none"> • Analog: Audio from audio input. • Digital : Audio from HDMI audio. 	<ol style="list-style-type: none"> 1 Press the ▲/▼ button on the control panel or the M/ button on the remote control to select the setting. 2 Press the + button on the control panel or the OK button on the remote control to set the value. 	Analog: VGA / DVI Digital: HDMI / DP
Audio reset	Reset all settings in the Audio menu to the factory preset values.	<ol style="list-style-type: none"> 1 Press the ▲/▼ button on the control panel or the ←/→ button on the remote control to select the setting. 2 Press the + button on the control panel or the OK button on the remote control to set the value. 	CANCEL RESET
Audio Out Sync	Enable/disable audio out (line out) volume adjustability to sync with internal speakers.	<ol style="list-style-type: none"> 1 Press the ▲/▼ button on the control panel or the M/ button on the remote control to select the setting. 2 Press the + button on the control panel or the OK button on the remote control to set the value. 	Off On
Speaker Setting	Enable/disable the internal speakers.	<ol style="list-style-type: none"> 1 Press the ▲/▼ button on the control panel or the M/ button on the remote control to select the setting. 2 Press the + button on the control panel or the OK button on the remote control to set the value. 	Off On

ADJUSTING THE LCD DISPLAY

6.4 Configuration1 Settings

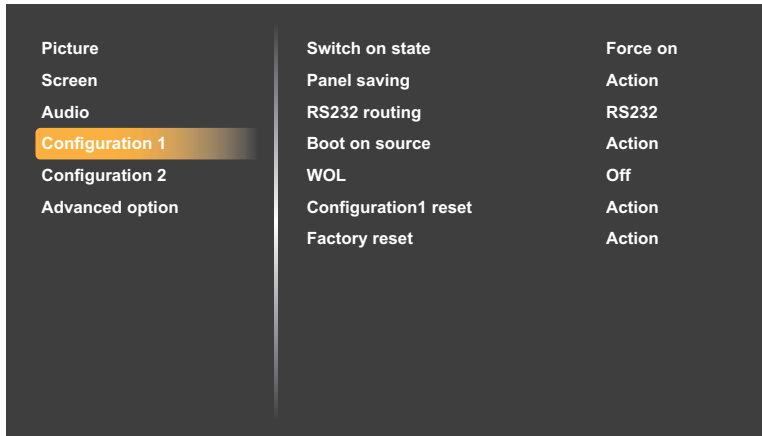

- 1 Press the **MENU** button on the control panel or the **HOME** button on the remote control to call out the OSD window.
- 2 Press the **▲/▼** button on the control panel or the **M** button on the remote control to select **Configuration 1**. Then press the **+** button on the control panel or the **OK** button on the remote control.
- 3 Press the **▲/▼** button on the control panel or the **M** button on the remote control to select an option.
- 4 Press the **+** button on the control panel or the **OK** button on the remote control to open the submenu item.

Item	Function	Operation	Range
Switch on state	<p>Select the display status used for the next time you connect the power cord.</p> <ul style="list-style-type: none"> • Power off: The display will remain off when the power cord is connected to a wall outlet. • Force on: The display will turn on when the power cord is connected to a wall outlet. • Last status: The display will return to the previous power status (on/off/standby) when removing and replacing the power cord. 	<ol style="list-style-type: none"> 1 Press the ▲/▼ button on the control panel or the M button on the remote control to select the setting. 2 Press the + button on the control panel or the OK button on the remote control to set the value. 	<p>Power off Force on Last status</p>

ADJUSTING THE LCD DISPLAY

Item	Function	Operation	Range
Panel saving	Choose to enable the panel saving functions and thus reduce the risk of "image persistence" or "ghost-imaging".	1 Press the ▲/▼ button on the control panel or the M button on the remote control to select the setting.	Brightness ANTI-BURN-IN™
	Brightness: Set to On and the image brightness will be reduced to an appropriate level. The Brightness setting in the Picture menu will be unavailable when selected.	2 Press the + button on the control panel or the OK button on the remote control to set the value.	Off On
	ANTI-BURN-IN™: Select the time interval for the display to slightly expand the image size and shift the position of pixels in four directions (up, down, left, or right). Note: Activating ANTI-BURN-IN™ will disable H Position, V Position and Zoom Mode in the Screen Menu.	Press the ▲/▼ button on the control panel or the ←/→ button on the remote control to adjust the value.	Off Auto 10 to 900 Seconds
RS232-Routing	Select the network control port.	1 Press the ▲/▼ button on the control panel or the M button on the remote control to select the setting. 2 Press the + button on the control panel or the OK button on the remote control to set the value.	RS232 LAN -> RS232
Boot on source	Set the default source at boot up.		
	Last Input: Input source is the same as at last boot.	1 Press the ▲/▼ button on the control panel or the ←/→ button on the remote control to select Last Input option. 2 Press the + button on the control panel or the OK button on the remote control to set the value.	CANCEL SAVE

ADJUSTING THE LCD DISPLAY

Item	Function	Operation	Range
Boot on source	Input: Input can be set to HDMI1, HDMI2, HDMI3, DVI-I, DisplayPort, VGA, SDM, or USB.	<ol style="list-style-type: none"> 1 Press the + button on the control panel or the OK button on the remote control to uncheck the Last Input option. 2 Press the ▲/▼ button on the control panel or the ↕ button on the remote control to select the Input option. 3 Press the + button on the control panel or the OK button on the remote control to set the value. <p>Note: If you set the input to USB then continue with setting the Playlist option in the following section (Playlist). If you set another input then follow steps 4 to 5.</p> <ol style="list-style-type: none"> 4 Press the ▼ button on the control panel or the ↓ button on the remote control. Then press the ▲/▼ button on the control panel or the ←/→ button on the remote control to select CANCEL or OK. 5 Press the + button on the control panel or the OK button on the remote control to set the value. 	HDMI1 HDMI2 HDMI3 DVI-I DisplayPort VGA SDM USB
	Playlist: Select playlist index (PlayList "0" ~ PlayList "8") for USB source. Note: If the Autoplay option in USB settings is enabled for video, and PlayList "8" is selected, the display will automatically play the media content from the Root folder of the external USB device. To enable Autoplay, refer to "4.2.4 USB Menu Settings" on page 38.	<ol style="list-style-type: none"> 1 Repeat steps 1 to 3 in the previous (Input) section. 2 Press the ▼ button on the control panel or the ↓ button on the remote control. Then press the ▲/▼ button on the control panel or the ↕ button on the remote control to select the playlist index. 3 Press the + button on the control panel or the OK button on the remote control to set the value. 4 Repeat steps 4 to 5 in the previous (Input) section. 	0 to 8 CANCEL SAVE

ADJUSTING THE LCD DISPLAY

Item	Function	Operation	Range
WOL	<p>Enable this feature to allow the display to be switched on over the network.</p> <p>Note:</p> <ul style="list-style-type: none"> To enter this menu option, you have to press the ⬆ button once followed by entering numbers “1”, “6”, “6”, and “8” on the remote control. Under the Network app, set the Ethernet setting to On or Static IP. Ensure that the Ethernet cable is properly connected to LAN port. 	<ol style="list-style-type: none"> Press the ▲/▼ button on the control panel or the ⬆/⬆ button on the remote control to select the setting. Press the + button on the control panel or the OK button on the remote control to set the value. 	<p>Off</p> <p>On</p>
Configuration1 reset	<p>Reset all settings in the Configuration1 menu to the factory preset values.</p>	<ol style="list-style-type: none"> Press the ▲/▼ button on the control panel or the ←/→ button on the remote control to select the setting. Press the + button on the control panel or the OK button on the remote control to set the value. 	<p>CANCEL</p> <p>RESET</p>
Factory reset	<p>Reset all your customized settings to the factory preset values.</p>	<ol style="list-style-type: none"> Press the ▲/▼ button on the control panel or the ←/→ button on the remote control to select the setting. Press the + button on the control panel or the OK button on the remote control to set the value. 	<p>CANCEL</p> <p>RESET</p>

ADJUSTING THE LCD DISPLAY

6.5 Configuration2 Settings

Picture	OSD turn off	45
Screen	OSD H position	50
Audio	OSD V position	50
Configuration 1	System rotation	Landscape
Configuration 2	Information OSD	10
Advanced option	Logo	On
	Monitor ID	Action
	Heat status	35.88°C 96.57°F
	Monitor information	Action
	DP version	
	HDMI Version	1.4
	Configuration2 reset	Action

- 1 Press the **MENU** button on the control panel or the **HOME** button on the remote control to call out the OSD window.
- 2 Press the **▲/▼** button on the control panel or the **M** button on the remote control to select **Configuration 2**. Then press the **+** button on the control panel or the **OK** button on the remote control.
- 3 Press the **▲/▼** button on the control panel or the **M** button on the remote control to select an option.
- 4 Press the **+** button on the control panel or the **OK** button on the remote control to open the submenu item.

Item	Function	Operation	Range
OSD turn off	Set the period of time the OSD menu stays on the screen.	Press the ▲/▼ button on the control panel or the ←/→ button on the remote control to adjust the value.	Off 5 to 120
OSD H position	Set the OSD menu horizontal position on the screen.		0 to 100
OSD V position	Set the OSD menu vertical position on the screen.		0 to 100
System rotation	Use this function to select the screen orientation. Note: <ul style="list-style-type: none"> • This option is available only if the input source is USB. • With other input sources, if the setting is set to Portrait, only the OSD menu screen will change to portrait. 	<ol style="list-style-type: none"> 1 Press the ▲/▼ button on the control panel or the ←/→ button on the remote control to select the setting. 2 Press the + button on the control panel or the OK button on the remote control to set the value. 	Landscape Portrait
Information OSD	Set the period of time the information OSD is displayed on the upper left corner of the screen. The information OSD will appear on the screen when the input signal is changed. The information OSD will remain on the screen if the setting is set to OFF .	Press the ▲/▼ button on the control panel or the ←/→ button on the remote control to adjust the value.	Off 1 to 60

ADJUSTING THE LCD DISPLAY

Item	Function	Operation	Range
Logo	<p>Choose to enable or disable the picture of Logo when you turn on your LCD display.</p> <p>Note:</p> <ul style="list-style-type: none"> If Logo is set to On then the OTS logo will show. If Log is set to Off then the scalar OTS logo will not show. If Logo is set to User then there will be no boot logo when power on. Logo will not rotate with rotation setting/detection. 	<ol style="list-style-type: none"> Press the ▲/▼ button on the control panel or the M button on the remote control to select the setting. Press the + button on the control panel or the OK button on the remote control to set the value. 	<p>Off</p> <p>On</p> <p>User</p>
Monitor ID	<p>Adjust the ID number for controlling the display via the LAN Control connection. Each display must have a unique ID number when multiple sets of this display are connected.</p>	<ol style="list-style-type: none"> Press the ▲/▼ button on the control panel or the M button on the remote control to select the setting. Press the + button on the control panel or the OK button on the remote control to set the value. Press the ▲/▼ button on the control panel or the ←/→ button on the remote control to adjust the value. 	<p>1 to 255</p>
Heat status	View the thermal status of the LCD display.		
Monitor information	View the information about your LCD display, including model name, serial number, operation hours, and software version.	N/A	
DP version	<p>Set the DP version to 1.1 or 1.2.</p> <p>Note: This option is available only if the input source is DisplayPort.</p>	<ol style="list-style-type: none"> Press the ▲/▼ button on the control panel or the M button on the remote control to select the setting. Press the + button on the control panel or the OK button on the remote control to set the value. 	<p>1.1</p> <p>1.2</p>

ADJUSTING THE LCD DISPLAY

Item	Function	Operation	Range
HDMI Version	Set the HDMI version to 1.4 or 2.0. Note: This option is available only if the input source is HDMI1, HDMI2, or HDMI3.	<ol style="list-style-type: none"> 1 Press the ▲/▼ button on the control panel or the M button on the remote control to select the setting. 2 Press the + button on the control panel or the OK button on the remote control to set the value. 	1.4 2.0
Configuration2 reset	Reset all settings in the Configuration2 menu to the factory preset values.	<ol style="list-style-type: none"> 1 Press the ▲/▼ button on the control panel or the ←/→ button on the remote control to select the setting. 2 Press the + button on the control panel or the OK button on the remote control to set the value. 	CANCEL RESET

ADJUSTING THE LCD DISPLAY

6.6 Advanced option Settings

Picture	IR control	Unlock
Screen	Power LED Light	On
Audio	Keyboard control	Unlock
Configuration 1	Uniwall	Action
Configuration 2	Off timer	Off
Advanced option	Date and time	Action
	Schedule	Action
	Alink	Off
	Auto signal detection	Off
	Language	English
	OSD transparency	Off
	Standby	Mode 1

- 1 Press the **MENU** button on the control panel or the **HOME** button on the remote control to call out the OSD window.
- 2 Press the **▲/▼** button on the control panel or the **M** button on the remote control to select **Advanced option**. Then press the **+** button on the control panel or the **OK** button on the remote control.
- 3 Press the **▲/▼** button on the control panel or the **M** button on the remote control to select an option.
- 4 Press the **+** button on the control panel or the **OK** button on the remote control to open the submenu item.

Item	Function	Operation	Range
IR control	<p>Select the operation mode of the remote control when multiple displays are connected via an RS232 connection.</p> <ul style="list-style-type: none"> • Normal: All displays can be operated normally by the remote control unit. • Primary: Designate this display as the primary display for remote control operation. Only this display can be operated by the remote control. (In primary mode, IR key will always be processed regardless the monitor id/group settings). • Secondary: Designate this display as the secondary display. This display can not be operated by the remote control, and will only receive the control signal from the primary display via the RS232 connection. • Lock All / Lock all but Volume / Lock all but Power / Lock all except PWR & VOL: Lock the remote control function of this display. To unlock, press and hold the i button on the remote control for 6 (six) seconds. 	<ol style="list-style-type: none"> 1 Press the ▲/▼ button on the control panel or the M button on the remote control to select the setting. 2 Press the + button on the control panel or the OK button on the remote control to set the value. 	Unlock Lock All Lock All but Volume Lock All but Power Lock All except PWR & VOL Primary Secondary

ADJUSTING THE LCD DISPLAY

Item	Function	Operation	Range
Power LED light	Set the display LED indicator on or off.	<ol style="list-style-type: none"> 1 Press the ▲/▼ button on the control panel or the M button on the remote control to select the setting. 2 Press the + button on the control panel or the OK button on the remote control to set the value. 	<p>On</p> <p>Off</p>
Keyboard control	<p>Enable or disable the keyboard (control panel buttons) function of the LCD display.</p> <ul style="list-style-type: none"> • Unlock: Enable the keyboard function. • Lock All / Lock all but Volume / Lock all but Power / Lock all except PWR & VOL: Disable all the keyboard function. <p>Note: To disable the keyboard control function, press both the + and ▲ on the control panel for more than 3 seconds.</p>	<ol style="list-style-type: none"> 1 Press the ▲/▼ button on the control panel or the M button on the remote control to select the setting. 2 Press the + button on the control panel or the OK button on the remote control to set the value. 	<p>Unlock</p> <p>Lock All</p> <p>Lock but Volume</p> <p>Lock All but Power</p> <p>Lock all except PWR & VOL</p>
Uniwall	<p>With this function you can create a single large-screen matrix (video wall) that consists of up to 150 sets of this display (up to 15-sets on the horizontal and 10-sets on the vertical sides). This function requires a daisy-chain connection.</p>	<ol style="list-style-type: none"> 1 Press the ▲/▼ button on the control panel or the M button on the remote control to select the setting. 2 Press the + button on the control panel or the OK button on the remote control to set the value. 3 Press the ▲/▼ button on the control panel or the ←/→ button on the remote control to adjust the value. 	1 to 15
	H monitors: Select the number of displays on the horizontal side.		1 to 10
	V monitors: Select the number of displays on the vertical side.		1 to 150
	Position: Select the position of this display in the screen matrix.		

ADJUSTING THE LCD DISPLAY

Item	Function	Operation	Range
Uniwall	<p>Frame comp.: If frame compensation is enabled, the display will adjust the image to compensate for the width of the display bezels in order to accurately display the image.</p>	<ol style="list-style-type: none"> 1 Press the ▲/▼ button on the control panel or the M button on the remote control to select the setting. 2 Press the + button on the control panel or the → button on the remote control to enable the function. 	-
	<p>Enable: If Uniwall is enabled, the display will apply the settings in H monitors, V monitors, Position, and Frame comp..</p> <p>Note: It is recommended to enable this function first, so that you can directly see the result when you configure the H monitors, V monitors, and Position settings.</p>		-
	<p>Switch On Delay: Set the power-on delaying time (in seconds).</p> <p>Note: If the setting is set to Auto, the system allows a sequential powering-on for each display by their ID number when multiple displays are connected.</p>	<ol style="list-style-type: none"> 1 Press the ▲/▼ button on the control panel or the M button on the remote control to select the setting. 2 Press the + button on the control panel or the OK button on the remote control to set the value. 3 Press the ▲/▼ button on the control panel or the ←/→ button on the remote control to adjust the value. 	Off Auto 2 to 255
Off timer	Switch off the display after a specified time (using the countdown timer).	Press the ▲/▼ button on the control panel or the ←/→ button on the remote control to adjust the value.	Off 1 to 24 Hours
Date and time	Adjust the current date and time for the display's internal clock.		
	<p>Note: The NTP Server is set automatically and cannot be altered.</p> <p>Auto Sync: Date and time are set automatically by the web server.</p>	<ol style="list-style-type: none"> 1 Press the ▲/▼ button on the control panel or the ←/→ button on the remote control to select Auto Sync option. 2 Press the + button on the control panel or the OK button on the remote control to set the value. 	Auto Sync

ADJUSTING THE LCD DISPLAY

Item	Function	Operation	Range
Date and time	Set date: Set date manually.	<ol style="list-style-type: none"> 1 Press the + button on the control panel or the OK button on the remote control to uncheck the Auto Sync option. 2 Press the ▲/▼ button on the control panel or the M button on the remote control to select the Set date option. 3 Press the + button on the control panel or the OK button on the remote control to open the year field. 4 Press the ▲/▼ button on the control panel or the M button on the remote control to select the year. 5 Press the + button on the control panel or the OK button on the remote control to set the value. 6 Press the ▼ button on the control panel or the ▶ button on the remote control to select the month field. 7 Repeat steps 4 to 5 to set the month. 8 Repeat steps 6 to 7 to set the day. 9 Press the ▼ button on the control panel or the ▼ button on the remote control. Then press the ▲/▼ button on the control panel or the ←/→ button on the remote control to select CANCEL or OK. 	CANCEL OK
	Set time: Set time manually.	Repeat steps 1 to 9 in the previous section (Set date) to set time.	CANCEL OK

ADJUSTING THE LCD DISPLAY

Item	Function	Operation	Range
Date and time	Choose time zone: Set the time zone in your area.	<ol style="list-style-type: none"> 1 Press the ▲/▼ button on the control panel or the M button on the remote control to select the Choose time zone field. 2 Press the + button on the control panel or the OK button on the remote control to set the value. 3 Press the ▲/▼ button on the control panel or the M button on the remote control to select the time zone. 4 Press the + button on the control panel or the OK button on the remote control to set the time zone. 	N/A (manually set)
Schedule	<p>This function allows you to program up to 7 different scheduled time intervals for this display to activate.</p> <p>You can set:</p> <ul style="list-style-type: none"> • Which input source the display will use for each scheduled activation period. • The time for the display to turn on and turn off. • The days in a week for the display to activate. <p>Note:</p> <ul style="list-style-type: none"> • We recommend you to set up current date and time in the Date and time menu before using this function. • After changing the Date and time option in the Advanced option menu, you need to set this Schedule again. 		
	After all the schedule parameters are set, you need to save the schedule.	Press the ▼ button on the control panel or the ↓ button on the remote control to access the BACK or SAVE option. Then press the ▲/▼ button on the control panel or the ←/→ button on the remote control to select BACK or SAVE .	BACK SAVE

ADJUSTING THE LCD DISPLAY

Item	Function	Operation	Range
Schedule	Schedule list: Select the schedule from the list that you want to configure.	<ol style="list-style-type: none"> 1 Press the + button on the control panel or the OK button on the remote control twice to access the Schedule list option. 2 Press the ▲/▼ button on the control panel or the M button on the remote control to select the schedule list from Schedule 1 to Schedule 7. 3 Press the + button on the control panel or the OK button on the remote control to set the schedule list. 4 Press the ▼ button on the control panel or the ▼ button on the remote control. Then press the ▲/▼ button on the control panel or the ←/→ button on the remote control to select CANCEL or OK. 	Schedule list 1 Schedule list 2 Schedule list 3 Schedule list 4 Schedule list 5 Schedule list 6 Schedule list 7 CANCEL OK
	Enable: Enable or disable the schedule.	<ol style="list-style-type: none"> 1 Press the ▲/▼ button on the control panel or the M button on the remote control to select the setting. 2 Press the + button on the control panel or the OK button on the remote control to set the setting. 3 Press the ▲/▼ button on the control panel or the M button on the remote control to select the option. 4 Press the + button on the control panel or the OK button on the remote control to set the option. 	Off On

ADJUSTING THE LCD DISPLAY

Item	Function	Operation	Range
Schedule	Start time: Set time when the schedule is turned on.	<ol style="list-style-type: none"> 1 Press the ▲/▼ button on the control panel or the M button on the remote control to select the Start time option. 2 Press the + button on the control panel or the OK button on the remote control to open the start time field. 3 Press the ▲/▼ button on the control panel or the M button on the remote control to select the hours. 4 Press the + button on the control panel or the OK button on the remote control to set the hours. 5 Press the ▼ button on the control panel or the ↓ button on the remote control. Then press the ▲/▼ button on the control panel or the ←/→ button on the remote control to select CANCEL or OK. 6 Press the ▼ button on the control panel or the ► button on the remote control to select the minutes field and repeat steps 2 to 5 to set the minutes. 	CANCEL OK
	End time: Set time when the schedule is turned off.	Repeat steps 1 to 6 in the previous section (Start time) to set end time.	CANCEL OK

ADJUSTING THE LCD DISPLAY

Item	Function	Operation	Range
Schedule	Input: Set the input source.	<ol style="list-style-type: none"> 1 Press the ▲/▼ button on the control panel or the M button on the remote control to select the Input option. 2 Press the + button on the control panel or the OK button on the remote control twice to open the input field. 3 Press the ▲/▼ button on the control panel or the M button on the remote control to select the input source. 4 Press the + button on the control panel or the OK button on the remote control to set the input source. 5 Press the ▼ button on the control panel or the ↓ button on the remote control. Then press the ▲/▼ button on the control panel or the ←/→ button on the remote control to select CANCEL or OK. 	HDMI1 HDMI2 HDMI3 DVI-I DisplayPort VGA SDM USB CANCEL OK
	Playlist: If you set the input to USB then you can set the playlist option.	Repeat steps 1 to 5 in the previous section (Input) to set the playlist option from 1 to 7.	CANCEL OK

ADJUSTING THE LCD DISPLAY

Item	Function	Operation	Range
Schedule	Days of the week: Select the days of the week when the schedule is active.	<ol style="list-style-type: none"> 1 Press the ▲/▼ button on the control panel or the M button on the remote control to select the Days of the week option. 2 Press the + button on the control panel or the OK button on the remote control twice to open the days of the week field. 3 Press the ▲/▼ button on the control panel or the M button on the remote control to select the day. 4 Press the + button on the control panel or the OK button on the remote control to set the day. Repeat steps 3 to 4 to set more days. 5 Press the ▼ button on the control panel or the ↓ button on the remote control repeatedly to access the SAVE option. Then press the + button on the control panel or the OK button on the remote control to save the settings. 	SUN MON TUE WED THU FRI SAT SAVE
	Every week: Check this option to run the schedule every week.	<ol style="list-style-type: none"> 1 Press the ▲/▼ button on the control panel or the M button on the remote control to select the Every week option. 2 Press the + button on the control panel or the OK button on the remote control to set the value. 	N/A
Alink	Alink control. <ul style="list-style-type: none"> • Off: Disable Alink. • On: Enable Alink. 	<ol style="list-style-type: none"> 1 Press the ▲/▼ button on the control panel or the M button on the remote control to select the setting. 2 Press the + button on the control panel or the OK button on the remote control to set the value. 	Off On

ADJUSTING THE LCD DISPLAY

Item	Function	Operation	Range
Auto signal detection	<p>Choose to let the display detect and display from available video inputs automatically.</p> <p>This function takes place only when there is no signal connected at the input port you designate for auto-detection.</p> <p>Note:</p> <ul style="list-style-type: none"> If the setting is set to All, the system will automatically search the available input signal in the following order: HDMI1, HDMI2, HDMI3, DVI-I, DisplayPort, VGA, SDM, or USB. If the setting is set to Failover, you can configure the input source priority list (Failover1~Failover8) in case of multiple sources. The default input source is HDMI1. 	<ol style="list-style-type: none"> Press the ▲/▼ button on the control panel or the M button on the remote control to select the setting. Press the + button on the control panel or the OK button on the remote control to set the value. 	<p>Off</p> <p>All</p> <p>Failover</p>
Language	Set the OSD language.	<ol style="list-style-type: none"> Press the + button on the control panel or the OK button on the remote control to select the value. Press the ▲/▼ button on the control panel or the M button on the remote control to select the setting. Press the + button on the control panel or the OK button on the remote control to set the setting. Press the ▼ button on the control panel or the ↓ button on the remote control. Then press the ▲/▼ button on the control panel or the ←/→ button on the remote control to select CANCEL or OK. 	<p>English</p> <p>Español</p> <p>Français</p> <p>Italiano</p> <p>Latviešu</p> <p>Lietuvių</p> <p>Nederlands</p> <p>Norsk bokmål</p> <p>Polski</p> <p>Português</p> <p>Suomi</p> <p>Svenska</p> <p>Türkçe</p> <p>Русский</p> <p>العربية</p> <p>简体中文</p> <p>繁體中文</p> <p>日本語</p> <p>Čeština</p> <p>Dansk</p> <p>Deutsch</p> <p>Eesti</p> <p>CANCEL</p> <p>OK</p>

ADJUSTING THE LCD DISPLAY

Item	Function	Operation	Range
OSD transparency	Adjust OSD transparency. <ul style="list-style-type: none"> • Off: Transparency is off. • 5-100: Transparency level is 5-100. 	Press the ▲/▼ button on the control panel or the ←/→ button on the remote control to adjust the value.	Off 5 to 100
Standby	Select the standby mode when the display cannot detect any input source signal. <ul style="list-style-type: none"> • Mode 1 [TCP off, WOL on, auto off] <ul style="list-style-type: none"> → DC off -> Power off. LED: Red. → Standby -> Power off. LED: Red • Mode 2 [TCP off, WOL on, auto on/off] <ul style="list-style-type: none"> → DC off -> Power off. LED: Red. → Standby -> Power Saving. LED: Orange. Can be wake up. • Mode 3 [TCP on, WOL off, auto on/off] <ul style="list-style-type: none"> → DC off -> Back light off. LED: Red. → Standby -> Back light off. LED: Orange. Can be wake up. • Mode 4 [TCP on, WOL off, no auto on/off] <ul style="list-style-type: none"> → DC off -> Back light off. LED: Red → Standby -> Will not enter standby mode. Only show "no signal". <p>Note: For RS232 and LAN control configuration, this setting must be set to Mode 3 or Mode 4.</p>	<ol style="list-style-type: none"> 1 Press the ▲/▼ button on the control panel or the M button on the remote control to select the setting. 2 Press the + button on the control panel or the OK button on the remote control to set the value. 	Mode 1 Mode 2 Mode 3 Mode 4

ADJUSTING THE LCD DISPLAY

Item	Function	Operation	Range
SDM settings	<p>Set the SDM configuration under each power condition.</p> <ul style="list-style-type: none"> • Auto: After selecting {SDM} for video source input, the SDM will be set to off when the display power is set to off, or set to on when the display power is set to on. When set to other video source inputs, the SDM will always be set to on. • Always off: The SDM will always be set to off. • Always on: The SDM will always be set to on. 	<ol style="list-style-type: none"> 1 Press the ▲/▼ button on the control panel or the M button on the remote control to select the setting. 2 Press the + button on the control panel or the OK button on the remote control to set the value. 	<p>Auto Always off Always on</p>
Advanced option reset	<p>Reset all settings except Date and Time in the Advanced option menu to factory preset values.</p>	<ol style="list-style-type: none"> 1 Press the ▲/▼ button on the control panel or the ←/→ button on the remote control to select the setting. 2 Press the + button on the control panel or the OK button on the remote control to set the value. 	<p>CANCEL RESET</p>

CHAPTER 7: APPENDIX

7.1 Warning Messages

Warning Messages	Cause	Solution
No signal!	The resolution or the refresh rate of the graphics card of the computer is set too high.	<ul style="list-style-type: none"> Change the resolution or the refresh rate of the graphics card.
No signal!	The LCD display cannot detect the input source signal.	<ul style="list-style-type: none"> Check if the input source is turned ON. Check if the signal cable is properly connected. Check if any pin inside the cable connector is twisted or broken.
(Action: Unable to use the control panel buttons.)	The operation using the control panel buttons has been locked by the user.	<ul style="list-style-type: none"> Disable the keyboard lock function in Advanced option > Keyboard control menu. See page 65.
(Action: Unable to use the remote control buttons.)	The operation using the remote control buttons has been locked by the user.	<ul style="list-style-type: none"> Disable the remote control lock function in Advanced option > IR control menu. See page 64.

7.2 Supported Media Formats

USB Multimedia Codec Formats

Video Decode					
Type	Video Codec	Container	Decode	Channel	Remark
MPEG1/2	MPEG1/2	<ul style="list-style-type: none"> MPEG program stream (.DAT, .VOB, .MPG, .MPEG) MPEG transport stream (.ts) MP4 (.mp4) AVI (.avi) MKV (.mkv) 	V		<ul style="list-style-type: none"> Max Resolution: 1080P@30fps Max Bit Rate: 40Mbps
MPEG-4	MPEG4	<ul style="list-style-type: none"> MP4 (.mp4) AVI (.avi) MKV (.mkv) 	V		<ul style="list-style-type: none"> Max Resolution: 1080P@30fps Max Bit Rate: 40Mbps
H.263	H.263	<ul style="list-style-type: none"> FLV (.flv) AVI (.avi) 	V		<ul style="list-style-type: none"> Max Resolution: 1080P@30fps Max Bit Rate: 40Mbps

APPENDIX

Video Decode					
Type	Video Codec	Container	Decode	Channel	Remark
H.264	H.264	<ul style="list-style-type: none"> • FLV (.flv) • MP4 (.mp4) • MPEG transport stream (.ts) • AVI (.avi) • MKV (.mkv) 	V		<ul style="list-style-type: none"> • Max Resolution: 4K2K@60fps • Max Bit Rate: 135Mbps
H.265	H.265	<ul style="list-style-type: none"> • MP4 (.mp4) • MPEG transport stream (.ts) • MKV (.mkv) 	V		<ul style="list-style-type: none"> • Max Resolution: 4K2K@60fps • Max Bit Rate: 100Mbps
GOOGLE VP8	VP8	<ul style="list-style-type: none"> • MKV (.mkv) • WebM (.webm) 	V		<ul style="list-style-type: none"> • Max Resolution: 1920x1080@30fps • Max Bit Rate: 50Mbps

Audio Decode					
Type	Audio Codec	Container	Decode	Channel	Remark
MPEG Audio	MPEG1/2/2.5 Audio Layer1/2/3	MP3	V	2	<ul style="list-style-type: none"> • Bit Rate: 8kbps~448Kbps • Sampling Rate: 16KHZ~48KHZ
AAC Audio	MAIN, ADIF, ATDS Header AAC-LC and AAC-HE	File Format: AAC, M4A	V	5.1	<ul style="list-style-type: none"> • Bit Rate: 3kbps~576kbps • Sampling Rate: 8KHZ~48KHz

Image Decode					
Type	Image Codec	Photo	Decode	Channel	Remark
JPEG	JPEG	File Format: JPG, JPEG	V		<ul style="list-style-type: none"> • Resolutionx: 1920 x 1080 (MediaTek suggests)
BMP	BMP	File Format: BMP	V		<ul style="list-style-type: none"> • Resolutionx: 15360 x 8640 (MediaTek suggests)
PNG	PNG	File Format: PNG	V		<ul style="list-style-type: none"> • Resolutionx: 1920 x 1080 (MediaTek suggests)

Note:

- ◆ If the content with the maximum resolution and bit rate larger than the specified in the table above still can be played back, but normal playback is not guaranteed.

APPENDIX

7.3 Input Mode

VGA Resolution

Standard Resolution	Active Resolution		Refresh Rate	Pixel Rate	Aspect Ratio	Stand for Mode
	Horizontal Pixels	Vertical Lines				
VGA	640	480	60 Hz	25.175 MHz	4:3	Video Graphic Array
			75 Hz	31.5 MHz		
WVGA	720	400	70 Hz	33.75 MHz	16:9	Wide Video Graphic Array
SVGA	800	600	60 Hz	40 MHz	4:3	Super VGA
XGA	1024	768	60 Hz	65 MHz	4:3	Extended Graphic Array
WXGA	1280	800	60 Hz	79.5 MHz	16:10	Wide XGA
SXGA	1280	1024	60 Hz	108 MHz	5:4	Super XGA
HD1080	1920	1080	60 Hz	148.5 MHz	16:9	HD1080

SD Resolution

Standard Resolution	Active Resolution		Refresh Rate	Pixel Rate	Aspect Ratio
	Horizontal Pixels	Vertical Lines			
480i	720	480	29.97 Hz	13.5 MHz	4:3
480p			59.94 Hz	27 MHz	
576i	720	576	25 Hz	13.5 MHz	4:3
576p			50 Hz	27 MHz	

HDTV Resolution

Standard Resolution	Active Resolution		Refresh Rate	Pixel Rate	Aspect Ratio
	Horizontal Pixels	Vertical Lines			
720p	1280	720	50 Hz	74.25 MHz	16:9
			60 Hz		
1080i	1920	1080	25 Hz	74.25 MHz	16:9
			30 Hz		
1080p	1920	1080	50 Hz	148.5 MHz	16:9
			60 Hz		
2160p (50/60 Hz: HDMI: 2.0 / DP:1.2)	3840	2160	30 Hz	297 MHz	16:9
			50 Hz	594 MHz	
			60 Hz		

General guidelines:

- The PC text quality is optimum in HD 1080 mode (1920 x 1080, 60Hz).
- Your PC display screen might appear different depending on the manufacturer (and your particular version of Windows).
- Check your PC instruction book for information about connecting your PC to a display.
- If a vertical and horizontal frequency-select mode exists, select 60Hz (vertical) and 31.5KHz (horizontal). In some cases, abnormal signals (such as stripes) might appear on the screen when the PC power is turned off (or if the PC is disconnected). If so, press the **SOURCE** button to enter the video mode. Also, make sure that the PC is connected.

APPENDIX

- When horizontal synchronous signals seem irregular in RGB mode, check PC power saving mode or cable connections.
- The display settings table complies to the IBM/VESA standards, and based on the analog input.
- The best timing for the vertical frequency to each mode is 60Hz.

7.4 Cleaning

Caution When Using the Display

- Do not bring your hands, face or objects close to the ventilation holes of the display. The top of the display is usually very hot due to the high temperature of exhaust air being released through the ventilation holes. Burns or personal injuries may occur if any body parts are brought too close. Placing any object near the top of the display could also result in heat related damage to the object as well as the display itself.
- Be sure to disconnect all cables before moving the display. Moving the display with its cables attached may damage the cables and thus cause fire or electric shock.
- Disconnect the power plug from the wall outlet as a safety precaution before carrying out any type of cleaning or maintenance procedure.

Front Panel Cleaning Instructions



- The front of the display has been specially treated. Wipe the surface gently using only a cleaning cloth or a soft, lint-free cloth.
- If the surface becomes dirty, soak a soft, lint-free cloth in a mild detergent solution. Wring the cloth to remove excess liquid. Wipe the surface of the display to remove dirt. Then use a dry cloth of the same type to dry.
- Do not scratch or hit the surface of the panel with fingers or hard objects of any kind.
- Do not use volatile substances such as insect sprays, solvents and thinners.

Cabinet Cleaning Instructions

- If the cabinet becomes dirty, wipe the cabinet with a soft, dry cloth.
- If the cabinet is extremely dirty, soak a lint-free cloth in a mild detergent solution. Wring the cloth to remove as much moisture as possible. Wipe the cabinet. Use another dry cloth to wipe over until the surface is dry.
- Do not allow any water or detergent to come into contact with the surface of the display. If water or moisture gets inside the unit, operating problems, electrical and shock hazards may result.
- Do not scratch or hit the cabinet with fingers or hard objects of any kind.
- Do not use volatile substances such as insect sprays, solvents and thinners on the cabinet.
- Do not place anything made from rubber or PVC near the cabinet for any extended periods of time.

APPENDIX

7.5 Troubleshooting

Symptom	Possible Cause	Remedy
No picture is displayed	<ul style="list-style-type: none"> The power cord has been disconnected. The main power switch on the back of the display is not switched on. The selected input has no connection. The display is in standby mode. 	<ol style="list-style-type: none"> 1 Plug in the power cord. 2 Make sure the power switch is switched on. 3 Connect a signal connection to the display.
Interference displayed on the display or audible noise is heard	Caused by surrounding electrical appliances or fluorescent lights.	Move the display to another location to see if the interference is reduced.
Colour is abnormal	The signal cable is not connected properly.	Make sure that the signal cable is attached firmly to the back of the display.
Picture is distorted with abnormal patterns	<ul style="list-style-type: none"> The signal cable is not connected properly. The input signal is beyond the capabilities of the display. 	<ul style="list-style-type: none"> Make sure that the signal cable is attached firmly. Check the video signal source to see if it is beyond the range of the display. Please verify its specifications with this display's specification section.
Display image doesn't fill up the full size of the screen	The picture format is not set correctly.	Press the  button and select a suitable picture format.
Can hear sound, but no picture	Improperly connected source signal cable.	Make sure that both video inputs and sound inputs are correctly connected.
Can see picture but no sound is heard	<ul style="list-style-type: none"> Improperly connected source signal cable. Volume is turned all the way down. MUTE function is turned on. No external speaker connected. 	<ul style="list-style-type: none"> Make sure that both video and sound inputs are correctly connected. Press the + or - button to hear the sound. Switch the MUTE function off by using the  button. Connect the external speakers and adjust the volume to a suitable level.
Some picture elements do not light up	Some pixels of the display may not turn on.	This display is manufactured using an extremely high level of precision technology: however, sometimes some pixels of the display may not display. This is not a malfunction.
After-Images can still be seen on the display after the display is powered off. (Examples of still pictures include logos, video games, computer images, and images displayed in 4:3 normal mode)	A still picture is displayed for an over extended period of time.	Do not allow a still image to be displayed for an extended period of time as this can cause a permanent after-image to remain on the display.

APPENDIX

7.6 Transporting the LCD Display

To transport the LCD display for repair or shipment, place the display in its original packaging carton.

PD-43Q

- 1 Place the LCD display inside the supplied protective bag.
- 2 Place the lower foam cushion inside the box.
- 3 Place the LCD display (a) inside the box.
- 4 Place the upper foam cushion (b) on top of the LCD display.
- 5 Put all accessories on their designated area.
- 6 Close and tape the box.

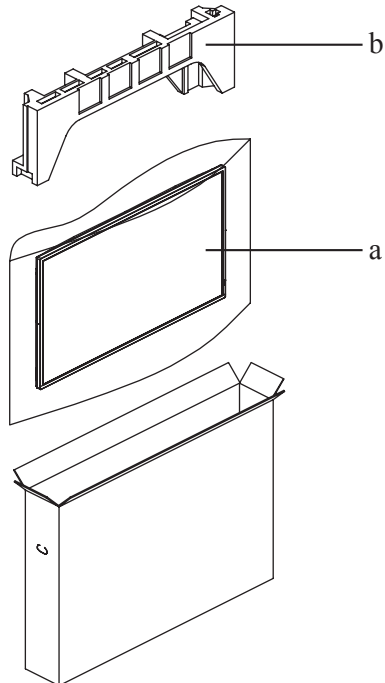

APPENDIX

PD-55Q

- 1 Place the LCD display inside the supplied protective bag.
- 2 Place the lower foam cushion (a) inside the lower box.
- 3 Place the LCD display (b) down in the lower box.
- 4 Place the upper foam cushion (c) on top of the LCD display.
- 5 Place the upper box (d) on the LCD display.
- 6 Put all accessories on their designated area.
- 7 Close and tape the upper box.
- 8 Secure the upper box to the lower box with the supplied locks (e).

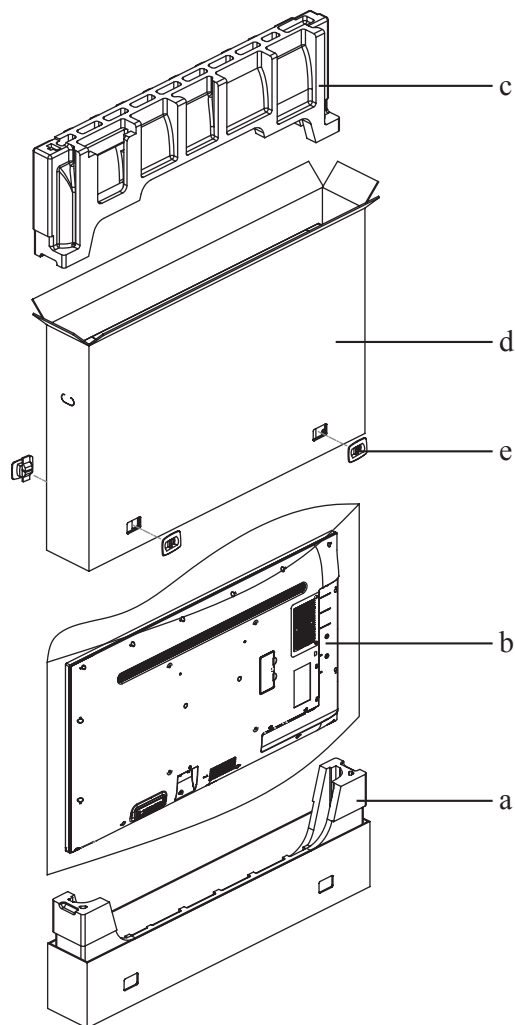

APPENDIX

PD-65Q

- 1 Place the LCD display inside the supplied protective bag.
- 2 Place the lower foam cushion (a) inside the lower box.
- 3 Place the LCD display (b) down in the lower box.
- 4 Place the upper foam cushion (c) on top of the LCD display.
- 5 Place the upper box (d) on the LCD display.
- 6 Put all accessories on their designated area.
- 7 Close and tape the upper box.
- 8 Secure the upper box to the lower box with the supplied locks (e).

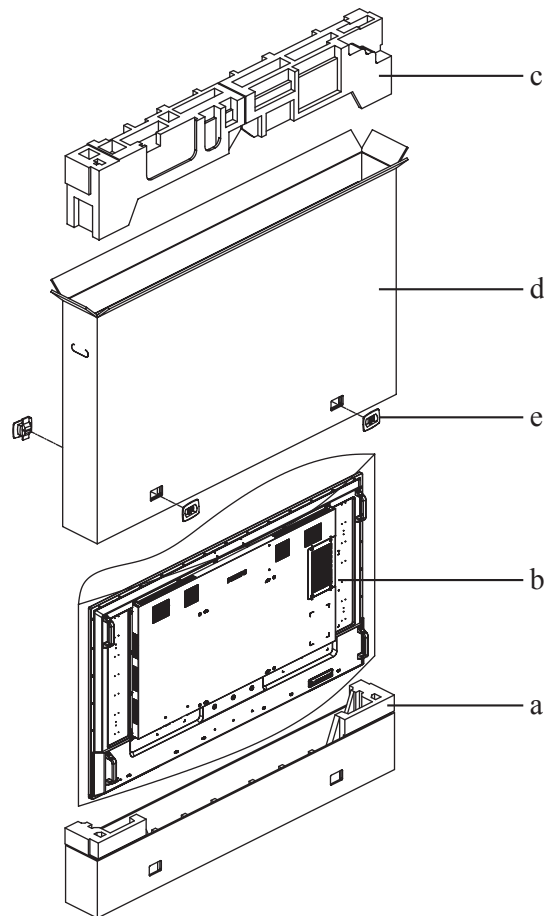

CHAPTER 8: SPECIFICATIONS

8.1 Display Specifications

		PD-43Q	PD-55Q	PD-65Q
Panel	Panel Type	LED-Backlit TFT LCD (IPS Technology)	LED-Backlit TFT LCD (IPS Technology)	LED-Backlit TFT LCD (IPS Technology)
	Panel Size	42.5"	55"	65"
	Max. Resolution	UHD 3840 x 2160	UHD 3840 x 2160	UHD 3840 x 2160
	Brightness	700 cd/m ²	700 cd/m ²	700 cd/m ²
	Contrast Ratio	1,200:1	5,000:1	1,200:1
	Viewing Angle (H/V)	178°/178°	178°/178°	178°/178°
	Display Colour	1.07 G	1.07 G	1.07 G
	Response Time	5 ms	5 ms	5 ms
Frequency (H/V)	H Freq.	31 kHz-92 kHz	31 kHz-92 kHz	31 kHz-92 kHz
	V Freq.	48 Hz-85 Hz	48 Hz-85 Hz	48 Hz-85 Hz
Input	DisplayPort	1.2 x 1	1.2 x 1	1.2 x 1
	HDMI	2.0 x 3	2.0 x 3	2.0 x 3
	DVI	29-Pin DVI-I x 1 (VGA)	29-Pin DVI-I x 1 (VGA)	29-Pin DVI-I x 1 (VGA)
Output	DisplayPort	1.2 x 1	1.2 x 1	1.2 x 1
External Control	IR In	3.5 mm Phone Jack	3.5 mm Phone Jack	3.5 mm Phone Jack
	IR Out	3.5 mm Phone Jack	3.5 mm Phone Jack	3.5 mm Phone Jack
	RS232 In	2.5 mm Phone Jack	2.5 mm Phone Jack	2.5 mm Phone Jack
	RS232 Out	2.5 mm Phone Jack	2.5 mm Phone Jack	2.5 mm Phone Jack
	LAN	RJ45 x 1	RJ45 x 1	RJ45 x 1
Other Connectivity	USB	2.0 x 1 (Service Port / Media Playback) / 2.0 x 1 (Media Playback)	2.0 x 1 (Service Port / Media Playback) / 2.0 x 1 (Media Playback)	2.0 x 1 (Service Port / Media Playback) / 2.0 x 1 (Media Playback)
	SDM Slot	SDM-S	SDM-L	SDM-L
	SD Card Slot	Yes	Yes	Yes
Audio	Audio In	Stereo Audio Jack (3.5 mm)	Stereo Audio Jack (3.5 mm)	Stereo Audio Jack (3.5 mm)
	Audio Out	Stereo Audio Jack (3.5 mm)	Stereo Audio Jack (3.5 mm)	Stereo Audio Jack (3.5 mm)
	Internal Speaker	10W x 2	10W x 2	10W x 2
Power	Power Supply	Internal	Internal	Internal
	Power Requirements	AC 100-240V, 50/60 Hz	AC 100-240V, 50/60 Hz	AC 100-240V, 50/60 Hz
	On Mode	123W(ON)	177W(ON)	199W(ON)
	Standby Mode	< 0.5W	< 0.5W	< 0.5W
	Off Mode	0W	0W	0W
Operating Conditions	Temperature	0°C-40°C (32°F-104°F)	0°C-40°C (32°F-104°F)	0°C-40°C (32°F-104°F)
	Humidity	20%-80% (non-condensing)	20%-80% (non-condensing)	20%-80% (non-condensing)
Storage Conditions	Temperature	-20°C-60°C (-4°F-140°F)	-20°C-60°C (-4°F-140°F)	-20°C-60°C (-4°F-140°F)
	Humidity	10%-90% (non-condensing)	10%-90% (non-condensing)	10%-90% (non-condensing)
Mounting	VESA FPMPI	Yes (200 x 200 mm)	Yes (400 x 400 mm)	Yes (400 x 400 mm)
Security	Kensington Security Socket	Yes	Yes	Yes
Dimensions	Product (W x H x D)	973.0 x 561.2 x 63.5 mm (38.3" x 22.1" x 2.5")	1241.8 x 712.6 x 63.6 mm (48.9" x 28.4" x 2.5")	1462.3 x 837.3 x 93.4 mm (27.6" x 33.0" x 3.7")
	Packaging (W x H x D)	1070.0 x 680.0 x 141.0 mm (42.1" x 26.8" x 5.6")	1350.0 x 860.0 x 160.0 mm (53.2" x 33.9" x 6.3")	1580.0 x 1050.0 x 151.0 mm (62.2" x 41.3" x 5.9")
Weight	Product	10.7 kg (23.6 lb)	16.6 kg (27.7 lb)	27.8 kg (61.3 lb)
	Packaging	13.1 kg (28.9 lb)	21.8 kg (48.1 lb)	33.9 kg (74.7 lb)

Note:

- ◆ All specifications are subject to change without prior notice.

SPECIFICATIONS

8.2 Display Dimensions

PD-43Q

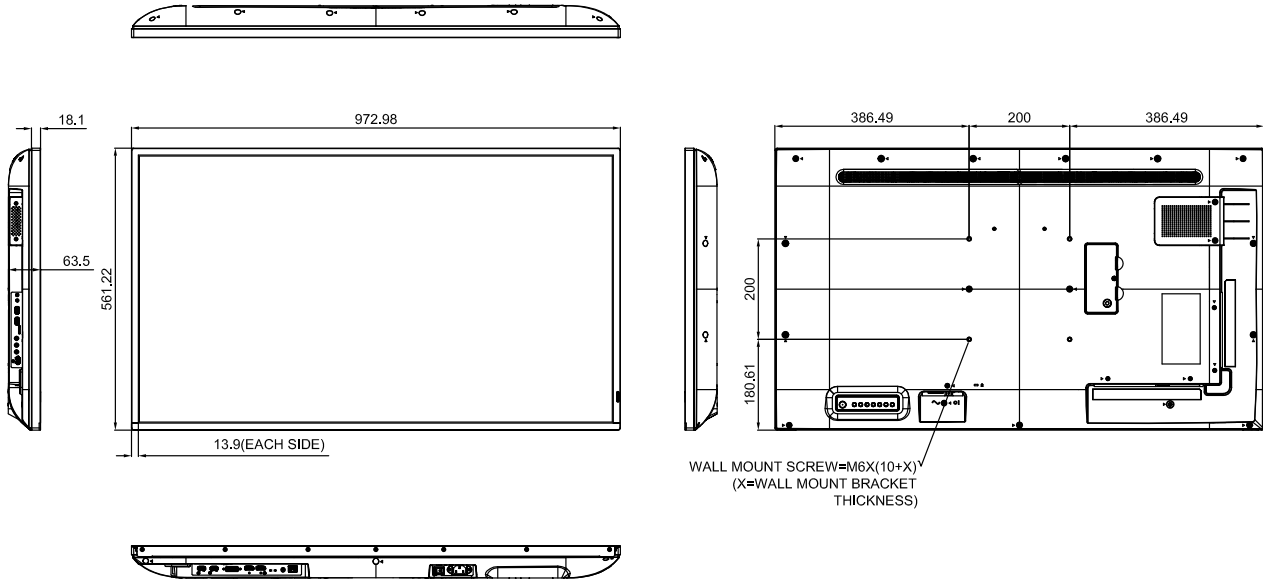

PD-55Q

