



Smart Interactive Whiteboard

User's Manual





Foreword

General

This manual introduces the functions and operations of the smart interactive whiteboard (hereinafter referred to as "the whiteboard"). Read carefully before using the whiteboard, and keep the manual safe for future reference.

Safety Instructions

The following signal words might appear in the manual.

Signal Words	Meaning
 WARNING	Indicates a medium or low potential hazard which, if not avoided, could result in slight or moderate injury.
 CAUTION	Indicates a potential risk which, if not avoided, could result in property damage, data loss, reductions in performance, or unpredictable result.
 NOTE	Provides additional information as a supplement to the text.

Revision History

Version	Revision Content	Release Time
V1.0.3	Updated the software functions.	March 2024
V1.0.2	Updated system parameters.	September 2023
V1.0.1	Updated the smart eye care function.	August 2023
V1.0.0	First release.	June 2023

Privacy Protection Notice

As the device user or data controller, you might collect the personal data of others such as their face, audio, fingerprints, and license plate number. You need to be in compliance with your local privacy protection laws and regulations to protect the legitimate rights and interests of other people by implementing measures which include but are not limited to: Providing clear and visible identification to inform people of the existence of the surveillance area and provide required contact information.

About the Manual

- The manual is for reference only. Slight differences might be found between the manual and the product.
- We are not liable for losses incurred due to operating the product in ways that are not in compliance with the manual.
- The manual will be updated according to the latest laws and regulations of related jurisdictions. For detailed information, see the paper user's manual, use our CD-ROM, scan the QR code or

visit our official website. The manual is for reference only. Slight differences might be found between the electronic version and the paper version.

- All designs and software are subject to change without prior written notice. Product updates might result in some differences appearing between the actual product and the manual. Please contact customer service for the latest program and supplementary documentation.
- There might be errors in the print or deviations in the description of the functions, operations and technical data. If there is any doubt or dispute, we reserve the right of final explanation.
- Upgrade the reader software or try other mainstream reader software if the manual (in PDF format) cannot be opened.
- All trademarks, registered trademarks and company names in the manual are properties of their respective owners.
- Please visit our website, contact the supplier or customer service if any problems occur while using the device.
- If there is any uncertainty or controversy, we reserve the right of final explanation.

Important Safeguards and Warnings

This section introduces content covering the proper handling of the whiteboard, hazard prevention, and prevention of property damage. Read carefully before using the whiteboard, and comply with the guidelines when using it.

Storage Requirements



- Stably put the whiteboard onto a support platform that is strong enough to prevent the whiteboard from falling.
- Do not place the whiteboard in a place exposed to sunlight or near heat sources.
- Store the whiteboard under allowed humidity (10%–90% (RH)) and temperature (–10 °C to +50 °C, or +14 °F to +122 °F) conditions.

Installation Requirements



- Use the wall mount bracket with yellow labels on it. Installation and maintenance must be performed by qualified professionals.
- Do not install the whiteboard in a place exposed to sunlight or near heat sources.
- Keep the whiteboard away from dampness, dust, and soot.
- Install the whiteboard on a stable surface to prevent it from falling.
- Install the whiteboard in a well-ventilated place, and do not block its ventilation.
- The power supply must conform to the requirements of ES1 in IEC 62368-1 standard and be no higher than PS2. Please note that the power supply requirements are subject to the device label.
- The whiteboard is a class I electrical appliance. Make sure that the power supply of the whiteboard is connected to a power socket with protective earthing.
- The appliance coupler is a disconnection device. Keep it at a convenient angle when using it.
- Only applicable for use in altitudes below 5,000 meters.

Operation Requirements



- High voltage inside the whiteboard. Do not disassemble the whiteboard without a qualified professional present to avoid the risk of being exposed to danger.
- Improper use of the battery might result in a fire or explosion.
- Replace unwanted batteries with new batteries of the same type and model.
- Use the standard power adapter. We will assume no responsibility for any problems caused by the use of a nonstandard power adapter.
- Use the power cords that are recommended for the region and conform to the rated power specifications.
- Make sure all cables are connected correctly before plugging the whiteboard into the power. Do not overload the power socket or pull the power code. Otherwise, it might cause fire or electric shock.

- Do not ingest battery. Chemical Burn Hazard. This product contains a coin cell battery. If the coin cell battery is swallowed, it can cause severe internal burns in just 2 hours and can lead to death.
- Keep new and used batteries away from children. If the battery compartment does not close securely, stop using the product and keep it away from children.
- If you think batteries might have been swallowed or placed inside any part of the body, seek immediate medical attention.



- The whiteboard can run continuously for up to 16 hours each day. Please do not keep it running for longer than this time, otherwise the life of the screen will be affected.
- Do not drop or splash liquid onto the whiteboard, and make sure that there is no object filled with liquid on the whiteboard to prevent liquid from flowing into it.
- Operate the whiteboard within the rated range of power input and output.
- Do not disassemble the whiteboard without professional instruction.
- Use the whiteboard under allowed humidity (10%–90% (RH)) and temperature (0 °C to 40 °C, or 32 °F to 104 °F) conditions.
- The whiteboard is a class I electrical appliance. Make sure that the power supply of the whiteboard is connected to a power socket with protective earthing.
- The appliance coupler is a disconnection device. Keep it at a convenient angle when using it.

Maintenance Requirements



- Power off the whiteboard before maintenance. Do not use the liquid cleaner or spray cleaner when cleaning the whiteboard.
- Use the clean and soft cloth or use the special lens wiping cloth when cleaning the surface of display screen. Do not use the wet cloth to clean the display screen. Otherwise, it may do harm to the screen.

Table of Contents

Foreword.....	I
Important Safeguards and Warnings.....	III
1 Overview.....	1
1.1 Introduction.....	1
1.2 Packing List.....	1
1.3 Appearance and Structure.....	1
1.3.1 Appearance.....	1
1.3.2 Dimensions.....	3
1.3.3 Ports.....	10
1.3.4 Buttons.....	13
2 Startup and Wakeup.....	14
2.1 Turning on the Whiteboard.....	14
2.2 Turning off Screen.....	15
3 Basic Operations.....	16
3.1 Quick Operations.....	16
3.1.1 Bringing up the Navigation Bar.....	16
3.1.2 Bringing up the Assistive Touch.....	17
3.1.3 Common Tools.....	18
3.2 Electronic Whiteboard.....	23
3.3 File Management.....	26
3.4 Screen Sharing.....	28
3.5 Welcome Page.....	28
3.6 System Settings.....	29
3.6.1 Configuring Network and Bluetooth Connection.....	29
3.6.2 Configuring General Settings.....	30
3.6.3 Configuring Advanced Parameters.....	32
3.6.4 Configuring System Parameters.....	34
4 Shutdown.....	36
5 System Update.....	37
5.1 Online Update.....	37
5.2 Update through USB.....	37
6 FAQ.....	38
Appendix 1 Touch Operation.....	39
Appendix 2 Security Commitment and Recommendation.....	40

1 Overview

1.1 Introduction

The smart interactive whiteboard is an integrated multimedia device, which integrates large HD screen, computer, electronic whiteboard, audio amplifier, application, and central control system. The whiteboard supports the following functions and features:

- 4K HD LCD display.
- Switch between Android and Windows systems (for Windows, you need to install a computer module).
- One-tap projection of devices such as mobile phones and tablets.
- Electronic whiteboard.
- Various software such as Microsoft Office and audio and video players.

1.2 Packing List

Check whether there is any obvious damage on the packing box. Unpack the box and check whether the components are complete according to the packing list.

Table 1-1 Packing list

Name	Quantity	Name	Quantity
Smart interactive whiteboard	1	Power cord	1
Stylus pen	2	HDMI cable	1
Wall mount bracket (installed on the whiteboard already)	1	Quick start guide	1
Accessory package	1	Remote control	1
Legal and regulatory information	1	—	—

1.3 Appearance and Structure

1.3.1 Appearance

Here we use the device with 65 inches as an example.

Figure 1-1 Appearance (with camera)

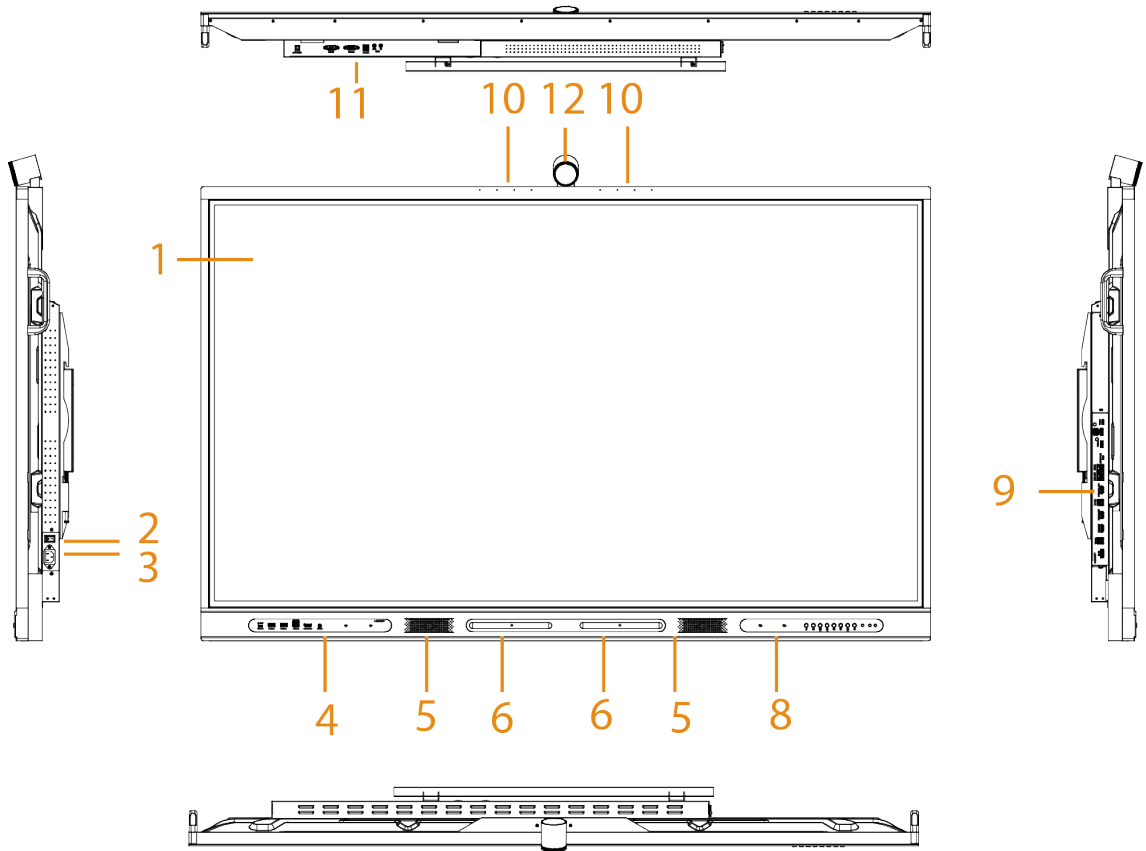

Figure 1-2 Appearance (without camera)

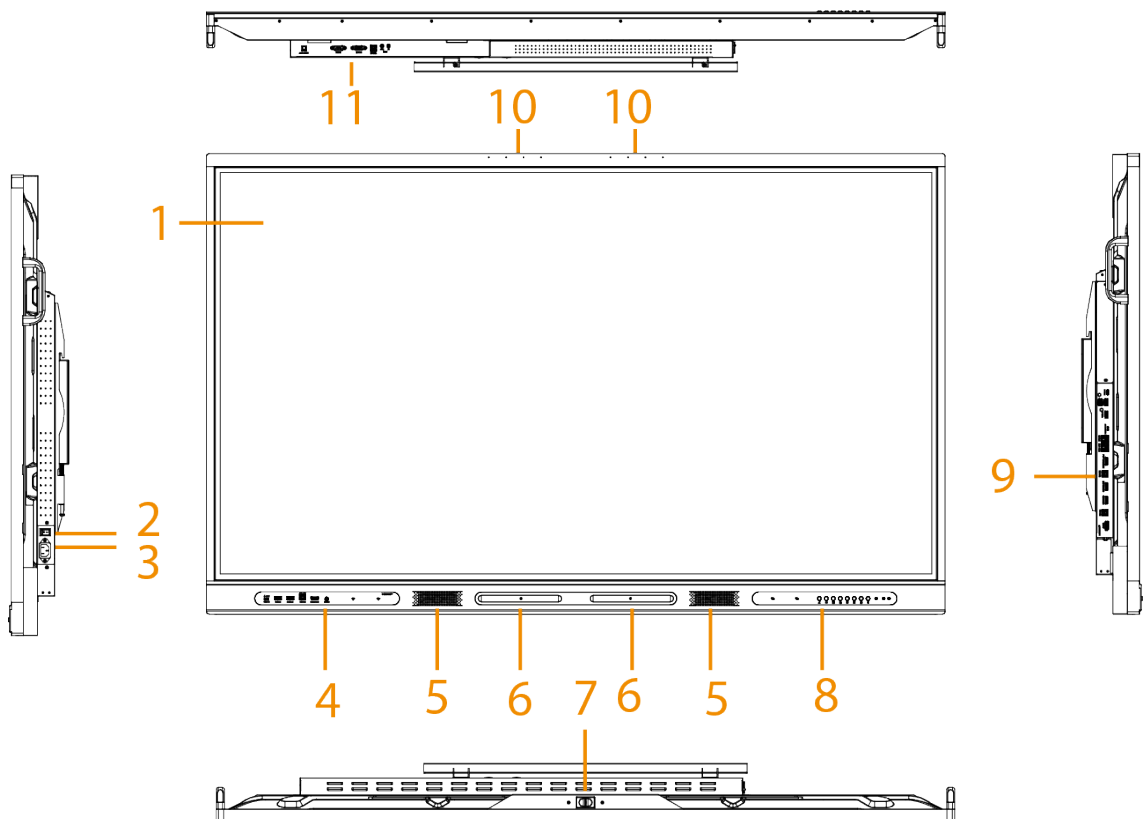



Table 1-2 Appearance description

No.	Description
1	LCD.
2	Power switch. Turn on or turn off the power supply of the whiteboard.
3	<p>Power input port. Inputs 100–240 VAC power.</p>  <p>After connecting to power supply, press the rocker switch to turn on the whiteboard.</p>
4	Ports on the front panel. For details, see Figure 1-9 .
5	Speaker holes.
6	Magnetic stylus pen attach area.
7	USB port for camera installation.
8	Buttons on the front panel. For details, see Table 1-6 .
9	Ports on the side of the rear panel. For details, see Table 1-4 .
10	Microphones. Pick up live audio.
11	Ports on the bottom of the rear panel. For details, see Table 1-5 .
12	<p>Camera.</p>  <p>You need to purchase the camera separately.</p>

1.3.2 Dimensions

1.3.2.1 Dimensions (65-inch)

Figure 1-3 Dimensions (with camera) (mm [inch])

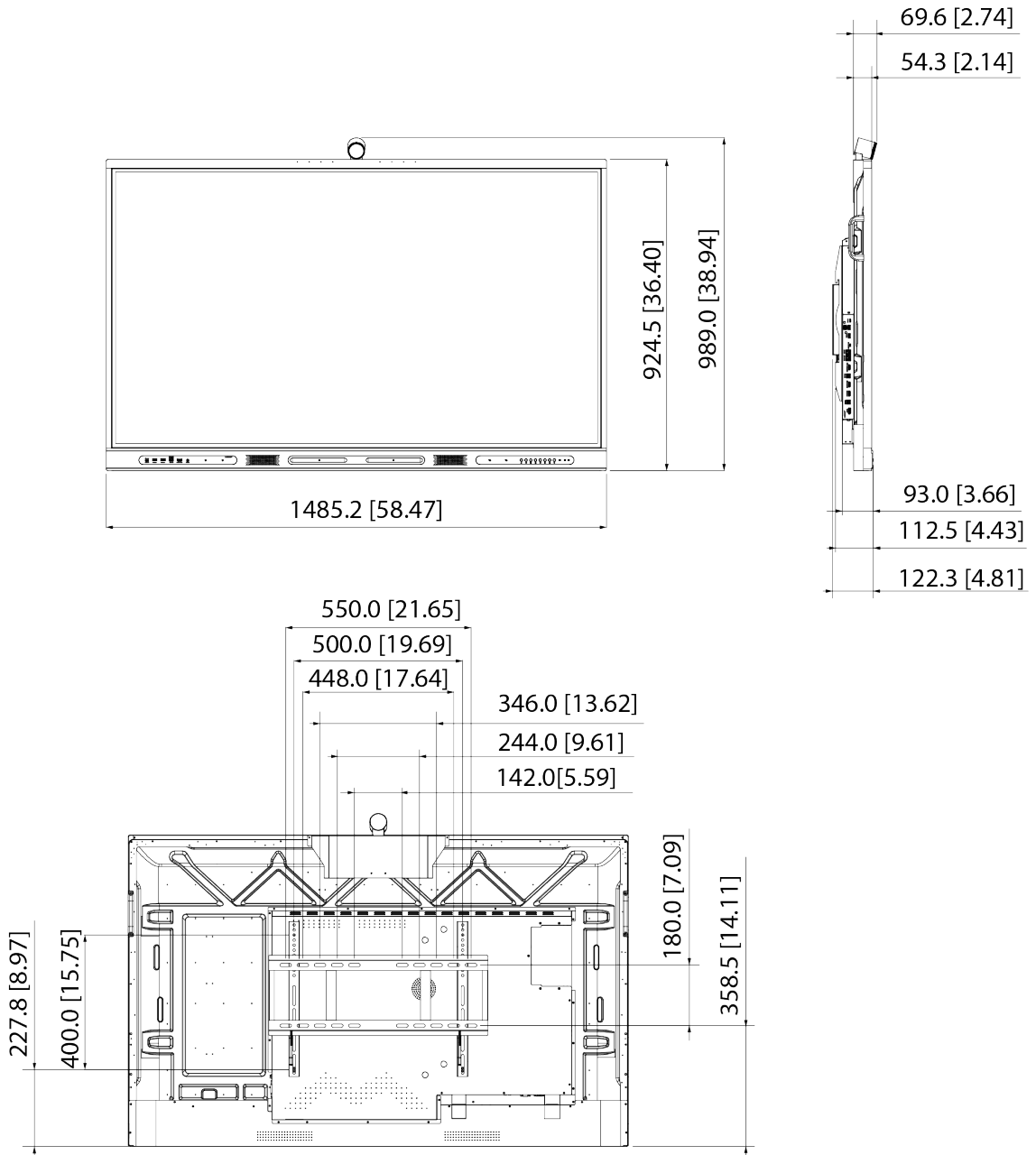
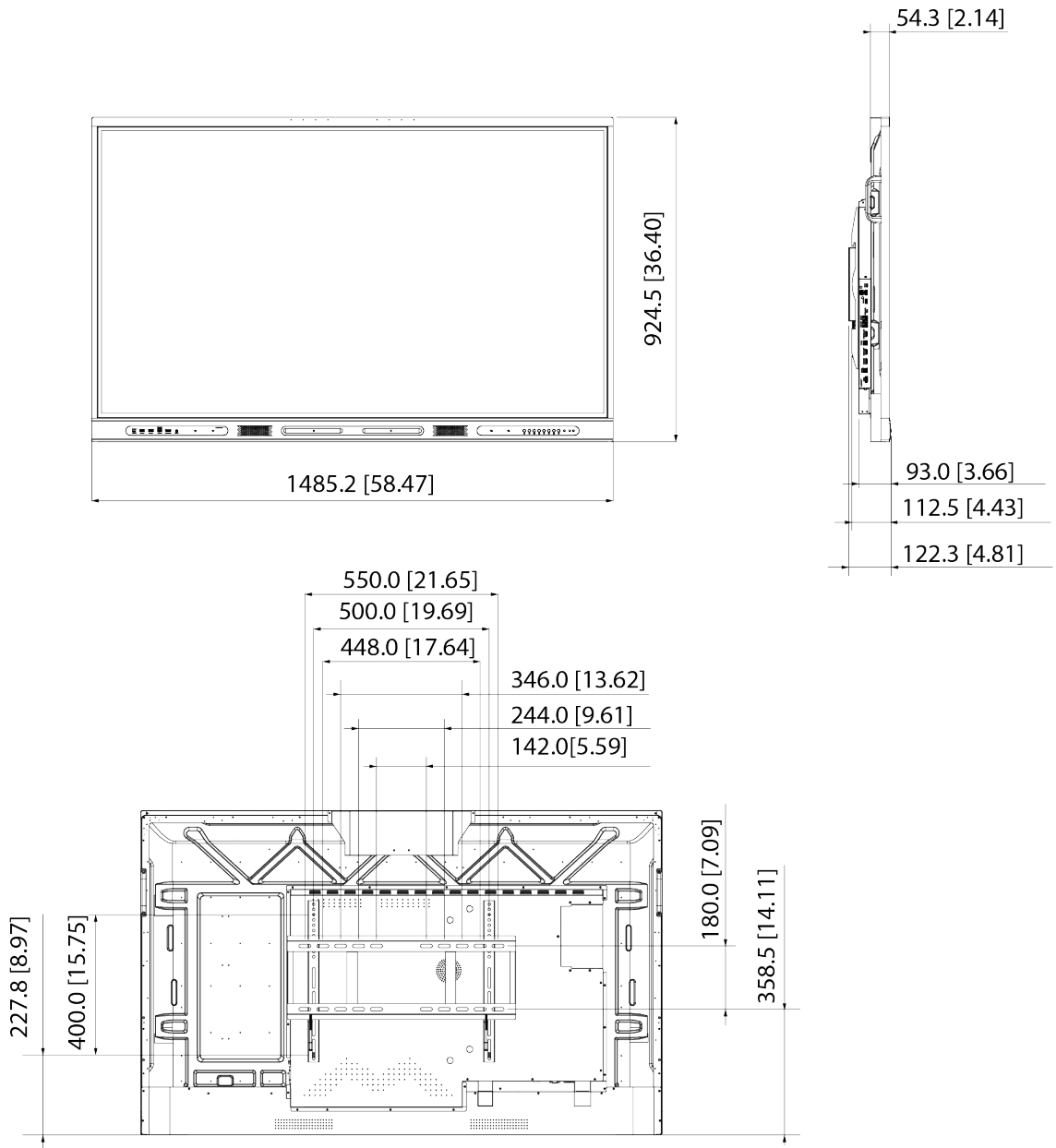

Figure 1-4 Dimensions (without camera) (mm [inch])



1.3.2.2 Dimensions (75-inch)

Figure 1-5 Dimensions (with camera) (mm[inch])

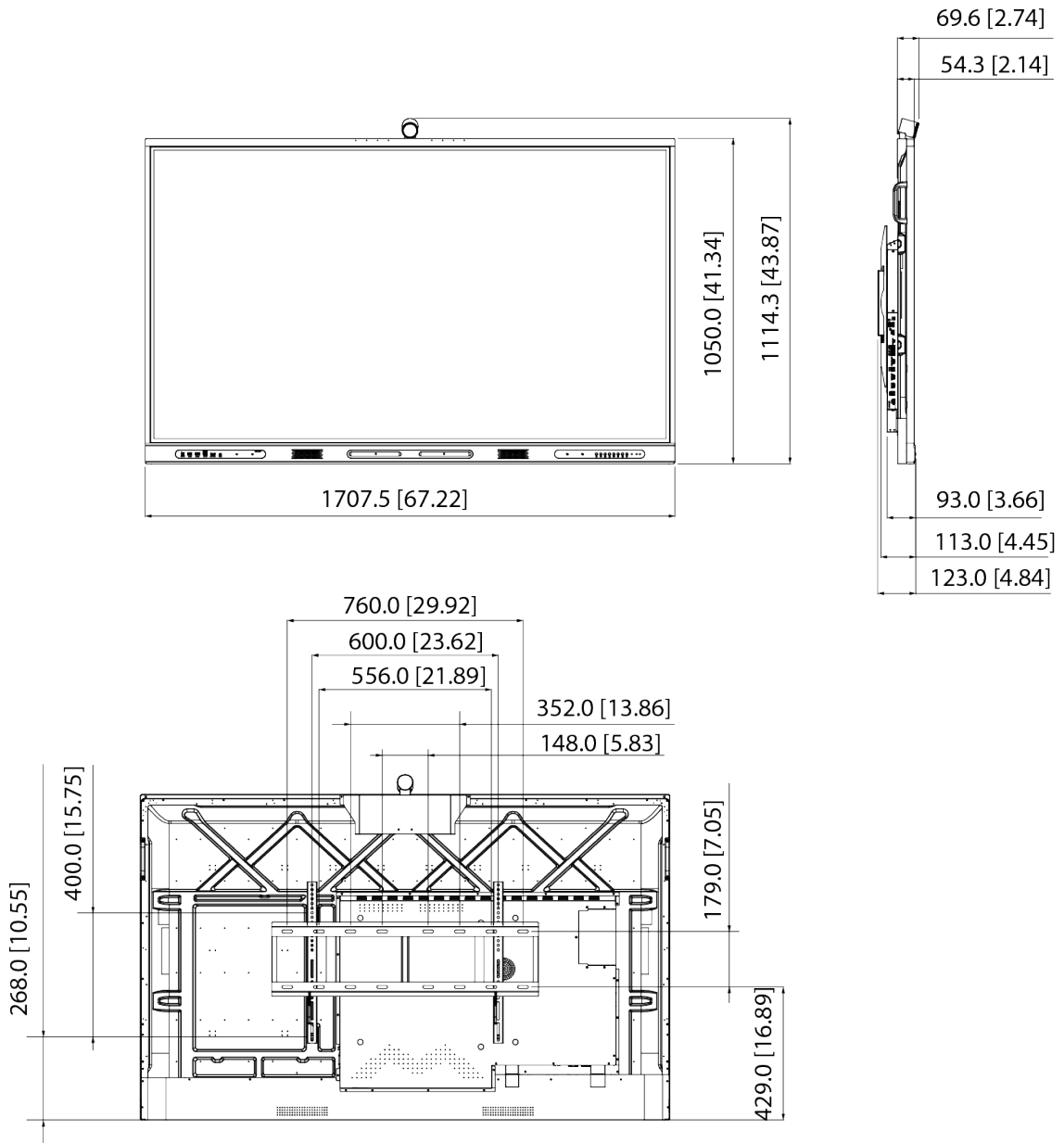
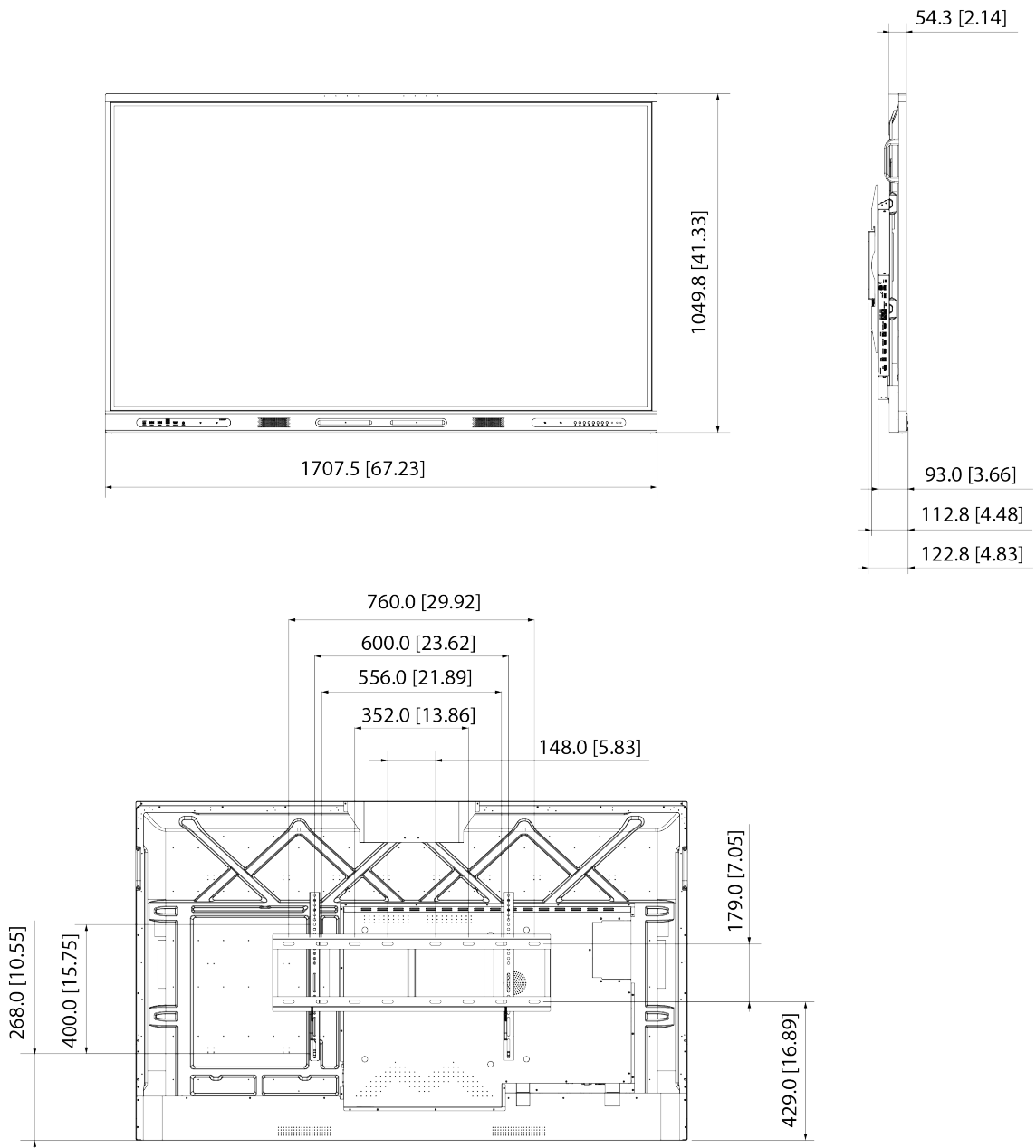

Figure 1-6 Dimensions (without camera) (mm[inch])



1.3.2.3 Dimensions (86-inch)

Figure 1-7 Dimensions (with camera) (mm[inch])

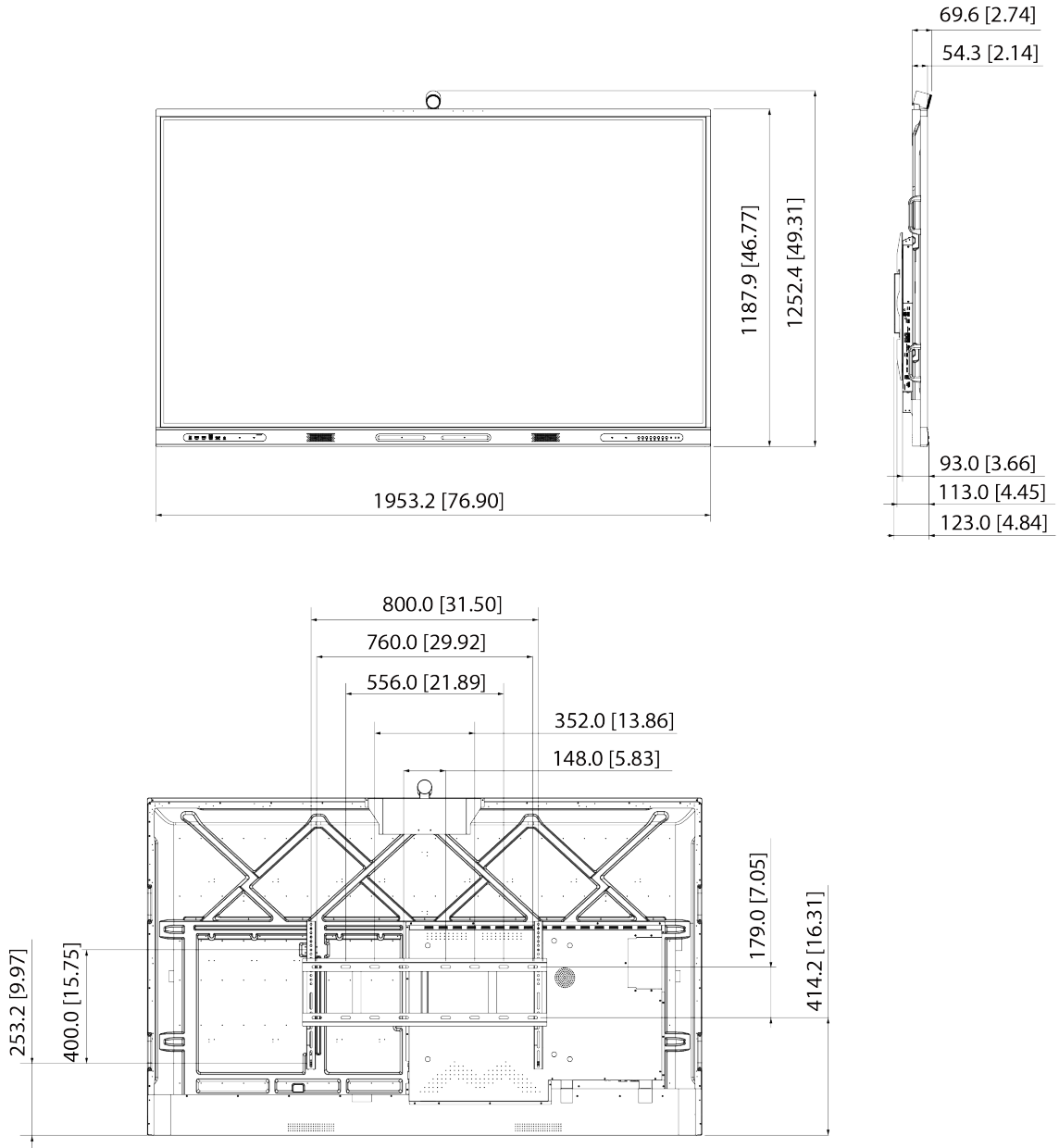
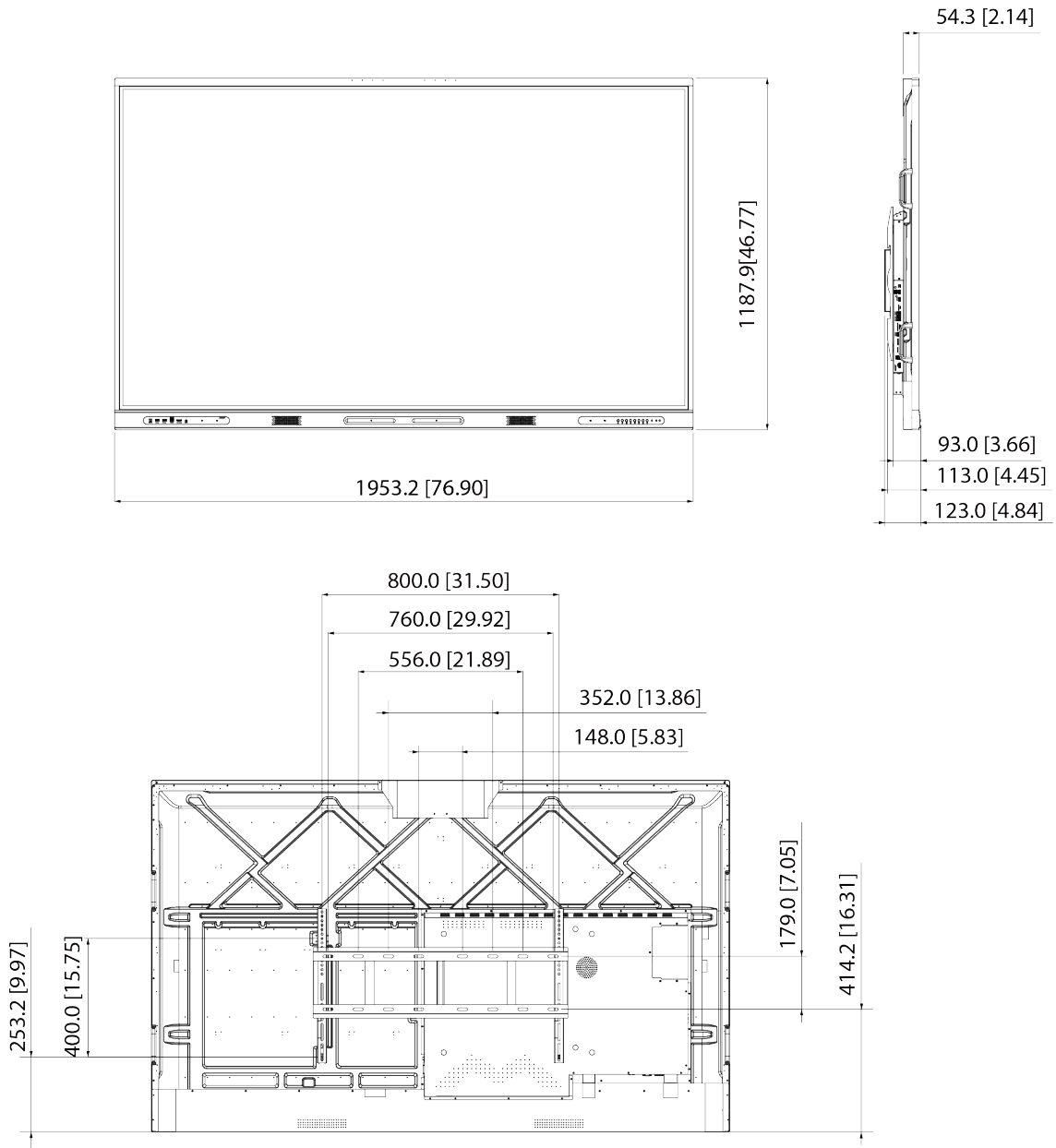

Figure 1-8 Dimensions (without camera) (mm[inch])



1.3.3 Ports

Figure 1-9 Ports on the front panel

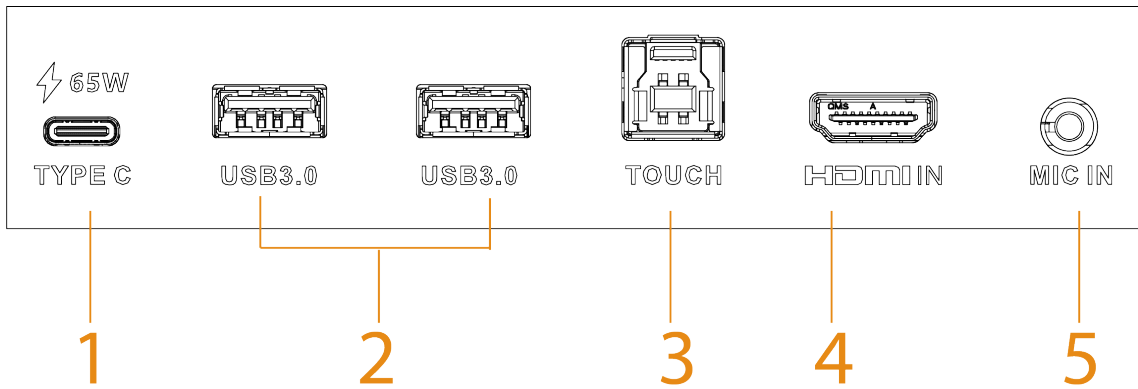

Table 1-3 Front panel ports

No.	Port	Description
1	Type C	Multi-function Type C port. It can be used for signal input and touch control.
2	USB 3.0	Connects to USB devices such as mobile hard disk, USB flash drive, USB keyboard, USB mouse. It is applicable to Android system and computer module. After you connect the whiteboard with your computer through the TYPE C, HDMI IN port and TOUCH port on the front panel, insert a USB device to the USB 3.0 port and then the USB device will be read and found on your computer.
3	TOUCH	Transmits touch signals. The port only works with the HDMI IN port next to it. After you connect your computer with the HDMI IN port, connect the TOUCH port to the USB port of the computer and then you can control the computer through touch operations on the whiteboard.
4	HDMI IN	Inputs uncompressed HD video signals and multichannel audio signals from the external HDMI signal source.
5	MIC IN	Audio input port.

Figure 1-10 Ports on the side of the rear panel

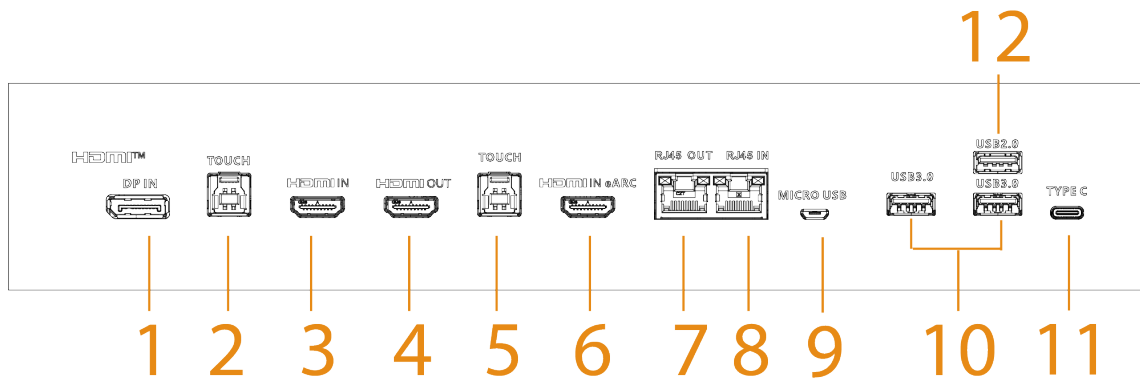



Table 1-4 Description of ports on the side of the rear panel

No.	Port	Description
1	DP IN	HD digital signal input port, which can be connected to computer and family theater.
2	TOUCH	Transmits touch signals. The port only works with the HDMI IN or DP IN port next to it. After you connect your computer with the whiteboard through the HDMI IN or DP IN port, connect the TOUCH port to the USB port of the computer and then you can control the computer through touch operations on the whiteboard.
3	HDMI IN	Inputs uncompressed HD video signals and multichannel audio signals from the external HDMI signal source.
4	HDMI OUT	HD audio and video signal output port. Transmits uncompressed HD video and multichannel audio data.
5	TOUCH	Transmits touch signals. The port only works with the HDMI IN eARC or HDMI IN (R) port next to it. After you connect your computer with the whiteboard through the HDMI IN eARC or HDMI IN (R) port, connect the TOUCH port to the USB port of the computer and then you can control the computer through touch operations on the whiteboard.
6	HDMI IN eARC	HDMI input port that supports enhanced audio return channel (eARC). Inputs video and audio signals from the external HDMI signal source.  To use the eARC function, you need to connect to devices that supports eARC.
7	RJ-45 OUT	Network output port. Connects to other devices so that the whiteboard can share network like a router.
8	RJ-45 IN	Network input port. Connects to the network cable to access network.

No.	Port	Description
9	Micro USB	Only applicable to Android system. Uses for system debugging.
10	USB 3.0	Connects to USB devices such as mobile hard disk, USB flash drive, USB keyboard, and USB mouse. It is applicable to Android system and computer module.
11	Type C	Multi-function Type C port. It can be used for signal input, and touch control.
12	USB 2.0	Connects to USB devices such as mobile hard disk, USB flash drive, USB keyboard, and USB mouse. Only available for Android system.

Figure 1-11 Ports on the bottom of the rear panel

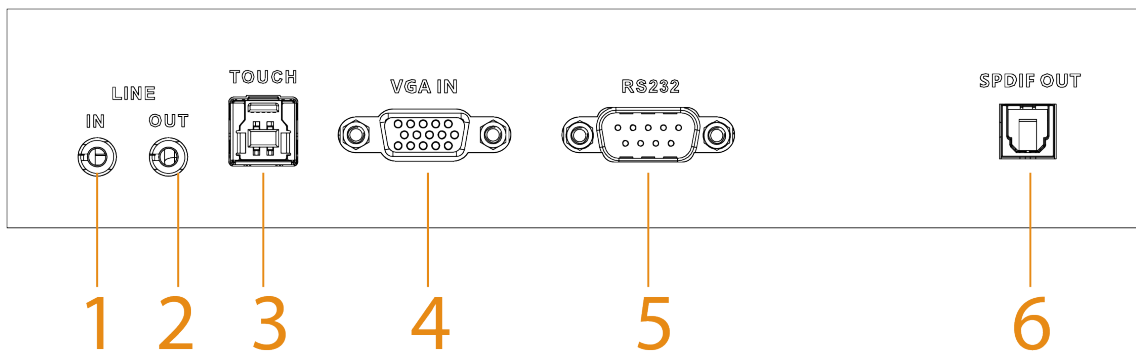

Table 1-5 Description of ports on the bottom of the rear panel

No.	Port	Description
1	LINE IN	Line input port. Works with VGA IN port.
2	LINE OUT	Line output port. Connects to earphones or speakers.
3	TOUCH	Transmits touch signals. The port only works with the VGA IN port next to it. After you connect your computer with the whiteboard through the VGA IN port, connect the TOUCH port to the USB port of the computer and then you can control the computer through touch operations on the whiteboard.
4	VGA IN	Video input port. Connects to computers, set-top boxes, and other video devices with VGA output ports.
5	RS-232	Transmits data between devices. Connect to central control devices with RS-232 port.
6	SPDIF OUT	Sony/Philips Digital Interface. Outputs audio to earphones or speakers.

1.3.4 Buttons

Figure 1-12 Buttons

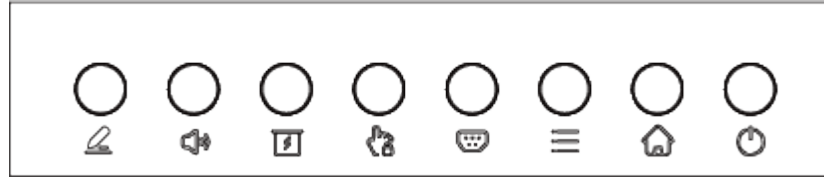











Table 1-6 Description of buttons

Button	Description
	Enter comment mode.
	Adjust volume.
	Enter curtain mode.
	Press the button to enable the touch lock.  When the touch lock is enabled, the touchscreen is not available. Press the power button 3 times to unlock the touch lock.
	Select signal sources.
	Open or close the navigation bar.
	Go back to the home screen.
	Power button. Turn on or turn off the screen.

2 Startup and Wakeup

2.1 Turning on the Whiteboard

Prerequisites

- Before starting the whiteboard, check whether the input voltage is correct against the power supply requirements.
- To ensure the stable work of the whiteboard and the external devices connected to the whiteboard and to prolong the service life, we recommend you refer to the national related standard to use the power source that provides stable voltage with less interference from ripples.

Procedure

- Step 1 Connect the power cord.
- Step 2 Press the "I" end of the rocker switch next to the power cord.
- Step 3 Press the power button on the right panel to turn on the screen.



After startup, the system displays the home screen by default.

Figure 2-1 Home screen



Table 2-1 Home screen description

No.	Description
1	Displays date, time and the day of the week.
2	Assistive touch. Tap the icon to quickly use functions as electronic whiteboard, annotation, and file management. See "3.1.2 Bringing up the Assistive Touch" for details.

No.	Description
3	Device status bar. Displays different status information. Tap each icon to view details.
4	Tap  to bring up the navigation bar. For details, see "3.1.1 Bringing up the Navigation Bar" for details.
5	Input source. Supports input sources such as Windows, HDMI, and Type C.
6	Function area. Tap a function icon to go to the corresponding operation screen.  For a third-party app, you can tap and hold the corresponding icon to uninstall the app. The apps that come with the system cannot be uninstalled in such way.

2.2 Turning off Screen

When the screen is on, press the power button once to turn off the screen.

After the screen has been off for 3 seconds, you can wake up the whiteboard in either of the following ways:

- Press the power button again.
- Touch the screen.



In the Windows system, if you have set a screen lock password, you need to enter the right password to wake up the whiteboard.

3 Basic Operations

The whiteboard can act as a computer or electronic whiteboard. This chapter introduces the basic operations of those functions. We recommend using the stylus pen to interact with the screen. For details on touch control, see "Appendix 1 Touch Operation".

3.1 Quick Operations

You can use the navigation bar or assistive touch to quickly use basic functions.

3.1.1 Bringing up the Navigation Bar

Tap  on the left and right sides of the home screen to bring up the navigation bar.

Figure 3-1 Navigation bar

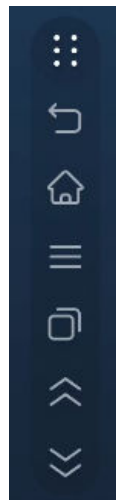









Table 3-1 Description of navigation bar

Icon	Description
	Display or hide the navigation bar.
	Go back to the previous screen.
	Go back to the home screen.
	Tap the icon to display common tools such as annotation, screen sharing, and camera. For details, see "3.1.3 Common Tools".
	Displays the apps that are running in the background. You can close the background apps one by one or in batches.
	Tap the icon to bring the screen to a higher point on the display. This function is not available in full-screen mode.
	Tap the icon to bring the screen down to a lower point on the display. Tap it again to bring it down even lower, until it is at a convenient level for you.

3.1.2 Bringing up the Assistive Touch

Tap  on the home screen to bring up the compass menu. For details, see "3.6.2 Configuring General Settings".

Figure 3-2 Assistive touch

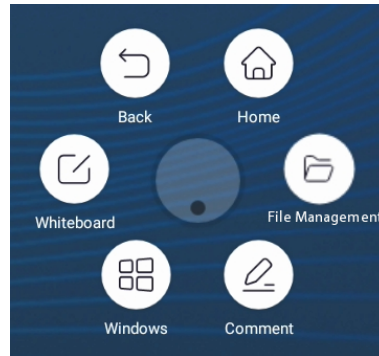













Table 3-2 Description of assistive touch

Icon	Description
	Go back to the home screen.
	Go back to the previous screen.
	Go to the electronic whiteboard screen. For details, see "3.2 Electronic Whiteboard".
	After you insert the computer module, tap the icon to switch to the Windows system.
	Turn on the annotation mode. <ul style="list-style-type: none"> ● Tap  to select the type of pen and the size of the brush. ● Tap  to clear content. <ul style="list-style-type: none"> ◇ Tap  to clear unwanted content. ◇ Tap , circle unwanted content, and then erase the selected content. ◇ Tap  to clear all content on the screen. ● Tap Save, and then select the path to save your annotations. ● Tap Exit to exit the annotation screen.
	Manage files.

3.1.3 Common Tools

Procedure



- Step 1 Tap  on the left and right sides of the home screen to display the navigation bar.
- Step 2 Tap  to display the common tools.

Figure 3-3 Common tools

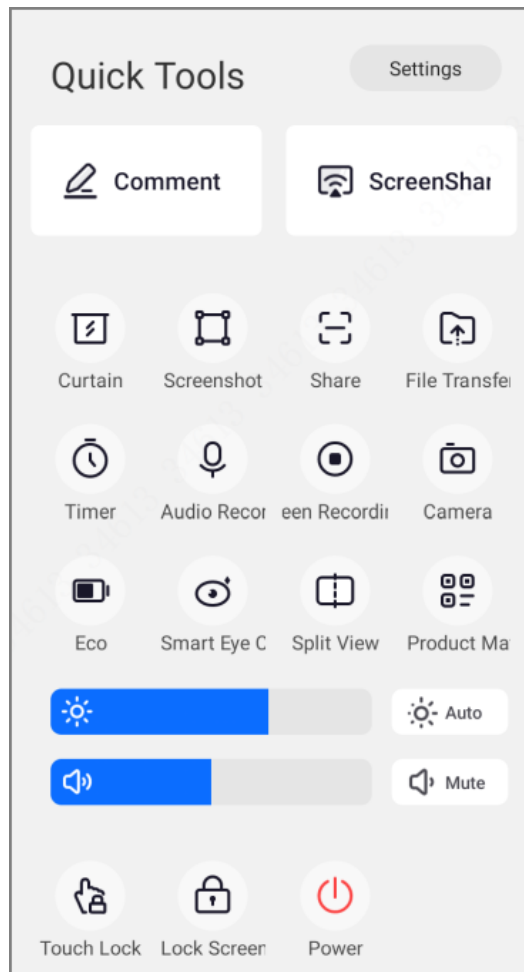





























Table 3-3 Description of common tools

Section	Function	Description
Quick tools	Settings	Go to the Settings screen. For details, see "3.6 System Settings".

Section	Function	Description
	Comment	Turn on the annotation mode. <ul style="list-style-type: none"> ● Tap  to select the type of pen and the size of the brush. ● Tap  to clear content. <ul style="list-style-type: none"> ◇ Tap  to clear unwanted content. ◇ Tap , circle unwanted content, and then erase the selected content. ◇ Tap  to clear all content on the screen. ● Tap Save, and then select the path to save your annotations. ● Tap Exit to exit the annotation screen.
	Wireless Screen Sharing	Tap the icon to use the wireless screen sharing function. You can share the screen of connected computer or phone on the whiteboard.
	Curtain	Tap the icon to enable the curtain mode. You can highlight the corresponding area as needed.
	Screenshot	Tap the icon, and then the middle area is selected by default. You can drag the four corners of the square to customize the area size. <ul style="list-style-type: none"> ● Tap , and then you can import the screenshot to the whiteboard with one tap. ● Tap  to capture the full screen. ● Tap  /  to choose the shape of the screenshot. ● Tap  to cancel the screenshot. ● Tap , and then the screenshot named year - month - day - hour - minute - second.jpg will be saved to the screenshot folder.

Section	Function	Description
	Share	<p>1. Tap the icon, and then select the files that you want to share.</p>  <p>You can select different types of files but cannot select folders.</p> <p>2. Tap OK, enter the password (4-8 digits) of the encrypted file, and then click OK.</p> <p>3. After a QR code is generated, you can scan the QR code to download the file.</p>  <ul style="list-style-type: none"> ● The QR code is only available in 60 seconds. After 60 seconds, you can tap to refresh it. ● The file sharing will be expired in 24 hours. Please download it in time. <p>If the whiteboard is connected to WAN, the QR sharing function will automatically use WAN. If the whiteboard is not connected to the WAN, the QR sharing function will automatically switch to the LAN.</p> <ul style="list-style-type: none"> ● LAN mode: Displays the name and password of the whiteboard hotspot. After you connect to the hotspot, use the camera app or browser on your phone to scan the code. You need to enter the verification password after downloaded the file. ● WAN mode: Does not display the name and password of the whiteboard hotspot. You need to enter the verification password after downloaded the file.  <p>File sharing poses a risk of data leakage. Keep the QR code and password safe.</p>
	File Transfer	You can transfer content to the whiteboard through the computer or phone.
	Timer	Tap the icon, and then the timer setting screen is displayed. You can start and pause the timer, set full-screen display of information on the timer, and reset the timer (reset is only available when the timer is paused, and it will reset to the initial state 00:00:00).
	Audio Recording	<p>Tap the icon to record the audio.</p> <ul style="list-style-type: none"> ●  : Start recording;  : Stop recording. The recorded file will be saved in .mp3 format. ●  : Close the function.  <p>The function is available only on devices with microphone.</p>

Section	Function	Description
	Screen Recording	<p>Tap the icon to record the screen.</p> <ul style="list-style-type: none">  : Start recording;  : Stop recording. Set the name for the recording in the pop-up page, and then tap Save.  : Start recording the sound from microphone. <p></p> <p>Audio recording is unable to be enabled during the screen recording.</p> <ul style="list-style-type: none">  : Close the function.
	Camera	<p>Tap the icon to take a picture.</p> <ul style="list-style-type: none"> Supports countdown settings, including: off, 3 s (default), 5 s, and 10 s. Tap Import Whiteboard, and then you can import the screenshot to the whiteboard with one tap. Tap  to save the picture to the local default folder. The picture is named year-month-day-hour-minute-second.png by default. Supports Share. <p></p> <p>Connect the whiteboard with an external camera first before using this function.</p>
	Eco	<p>With this function enabled, the backlight is set to a lower value. The backlight brightness can be adjusted manually or automatically.</p>

Section	Function	Description
	Smart Eye Care	<p>Enable or disable the eye care function.</p> <p>With this function enabled, the whiteboard will reduce the intensity of its blue light and change the screen to eye care mode.</p>  <ul style="list-style-type: none"> ● The whiteboard is optimized by software to filter harmful blue laser, and can realize no visible screen flickering between 0 Hz and 3,000 Hz. <ul style="list-style-type: none"> ◇ Blue laser is a relatively high energy light with a wavelength between 380 nm and 500 nm, and the blue laser within the certain wavelength is harmful to the human body. ◇ Screen flickering means that the light source is pulsating and unstable because the light changes rapidly and repeatedly, resulting in dry eyes and decreased vision. ● Do not use the whiteboard for a long time. We recommend you rest for 10 minutes every hour. ● During the break, we recommend you look far away or do the eye exercises.
	Split View	<p>Tap the icon to display the 2-split screen.</p> <ol style="list-style-type: none"> 1. Click the icon, and then the system displays the applications which support this function. Currently this function is available for whiteboard, system setting, Chrome, WPS and Eshare. 2. Drag the application to the left side first, and then select another application to be displayed on the right side.  <ul style="list-style-type: none"> ● You can adjust the size of the left and right screen. ● Drag the middle bar to the far left or far right of the screen to exit split screen mode.
	Product Material	Tap the icon to display the QR code. You can scan the QR code to view the manuals.
	Brightness	Drag the slider to adjust the backlight brightness. You can tap AUTO to enable the auto adjustment function. The whiteboard can automatically adjust the brightness according to the environment. For details, see "3.6.2 Configuring General Settings".
	Volume	Drag the slider to adjust the volume. Tap MUTE to enable mute.
	Touch Lock	<p>Tap the icon to disable touch control for the screen.</p>  <p>Press the power button 3 times to unlock the touch control.</p>
	Lock Screen	Tap the icon to lock the screen. Swipe the button in the middle of the screen to unlock the screen.

Section	Function	Description
	Power	Tap the icon to shut down, restart the whiteboard, or exit Windows.
Update notification bar	—	<ul style="list-style-type: none"> After you enable update through the cloud platform and connect the whiteboard to a WAN network, the system will pop up an update prompt window when a newer version is pushed from the platform. If you select to update later, the message that prompts you to update the system appears in the update notification bar. When the update package is downloaded, the system prompts you to install the package. If you select to install later, the message that prompts you to install the package appears in the update notification bar.  <p>When there is no newer version available, the update notification bar is hidden.</p>

3.2 Electronic Whiteboard

Tap **Whiteboard** on the home screen to open the whiteboard software. You can write or draw pictures on the screen.

Figure 3-4 Electronic whiteboard

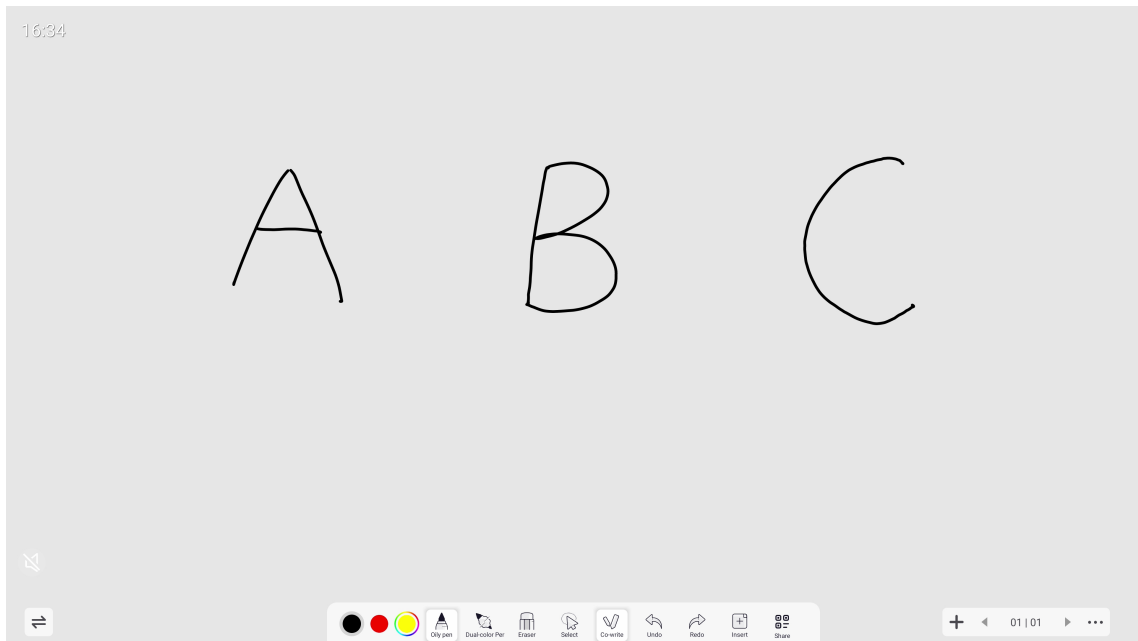



















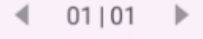





Table 3-4 Description of whiteboard icons

Icon	Description
	Adjust the location of the whiteboard tool bar.
	Select or customize the color of the pen.

Icon	Description
	<p>Select the type of pen and the size of the brush.</p> <ul style="list-style-type: none">  : Oily pen. By default, the color of the brush is black with 0 transparency.  : Mark pen. By default, the color of the brush is yellow with 40% transparency.  : Fountain pen. By default, the color of the brush is black with 0 transparency.  : Smart text. The handwritten content is recognized and transformed to the standard font with the color and thickness the same as the oily pen. <p></p> <p>Smart text is only available for English. When you write in other languages, the content cannot be recognized and transformed.</p> <ul style="list-style-type: none">  : Intelligent Formula. Simple equations (such as addition, subtraction, multiplication and division) can be calculated by the system.  : Smart graphics. The hand-drawn graphics are recognized and transformed to standard graphics with the color and thickness the same as the oily pen. The system can recognize lines, arrows, circles, quadrilaterals, pentagrams, and more.  : Laser pen. The written content appears with a trail and disappears in 1 second. The color can be green, red, and pink.
	<p>Select or customize the color of top the pen and bottom of pen.</p>
	<p>Erase content.</p> <ul style="list-style-type: none"> Tap  to clear unwanted content. Tap , circle unwanted content, and then erase the selected content. Tap  to clear all content on the screen. <p></p> <p>You can press your palm on the screen and then move your hand over the words to erase them.</p>
Select	Select content on the screen to zoom in, zoom out, move or rotate.
Co-write	<p>Switch between zoom mode and co-write mode.</p> <ul style="list-style-type: none"> Zoom mode: Only supports one-point writing. You can zoom in and zoom out the canvas. Co-write mode: Supports 10 pens writing simultaneously. You cannot zoom in or zoom out the canvas.
Undo	Undo the previous action. You can undo up to 10 actions.
Redo	Redo the action that has been undone. You can redo up to 10 actions.

Icon	Description
Insert	<ul style="list-style-type: none"> ● Video online: You can search the online video, and then display the video on the whiteboard. ● Image online: You can search the online image, and then insert it. ● Image: You can insert images in the bmp, png, jpg, jpeg or gif format. Up to 10 images in total can be inserted. ● Graphic: Select a type of graphic that you want to insert. ● Table: The default table layout is 3 × 3. The table supports up to 6 columns and 6 rows.  <p style="background-color: #f0f0f0; padding: 2px;">Video online and Image online are available on select models.</p>
Share	Download the written whiteboard file.
	Add a whiteboard page. You can add up to 50 pages.
	Tap  to preview the saved file list. Tap the file to edit. When you have created several files, tap  or  to switch to the previous file and the next file. You can browse the thumbnail of the switch page.

Icon	Description
	<p>Tap the icon, and then you can perform the following operations.</p> <ul style="list-style-type: none"> ● New : Create a new whiteboard file. Remember to save your content before creating a new file, or else you will lose all your changes. ● Open : Open the saved writing file. Only the whiteboard file format can be opened. After you tap Open, the system will jump to the whiteboard file column on file management screen. ● Change Background : You can use a local background template or custom template. The custom template only supports images in bmp, png, jpg and jpeg formats. The image size is limited to 5 MB. The recommended image ratio is 16:9. ● Save : Save the file. The default name of the file is year-month-day-hour-minute-second. You can customize the file name. The file format can be wbh (source file format), pdf, and png. The source file format is used by default. ● Save as : Save as a new file. The default file name is year-month-day-hour-minute-second. The file format can be wbh (source file format), pdf, and png. The source file format is used by default. ● Share by Email : Send the file through the Email. <ol style="list-style-type: none"> 1. Configure the information of sender. For details, see Table 3-7 . 2. Manually add the recipient. <ul style="list-style-type: none"> ◇ Up to 10 recipients can be added. ◇ The name of attachment is generated by system automatically and cannot be changed. 3. Tap Send , and then tap Finish. ● Exit : Exit the whiteboard app. Remember to save your modifications before exiting, or you will lose all your changes.

3.3 File Management

Manage local files and files on the USB drive.

Tap **File Manager** on the home screen to view the whiteboard files, images, documents and more.



- Tap and hold a file or folder to select the file or folder.
- Double-tap a file or folder to open the file or folder.

Figure 3-5 File management

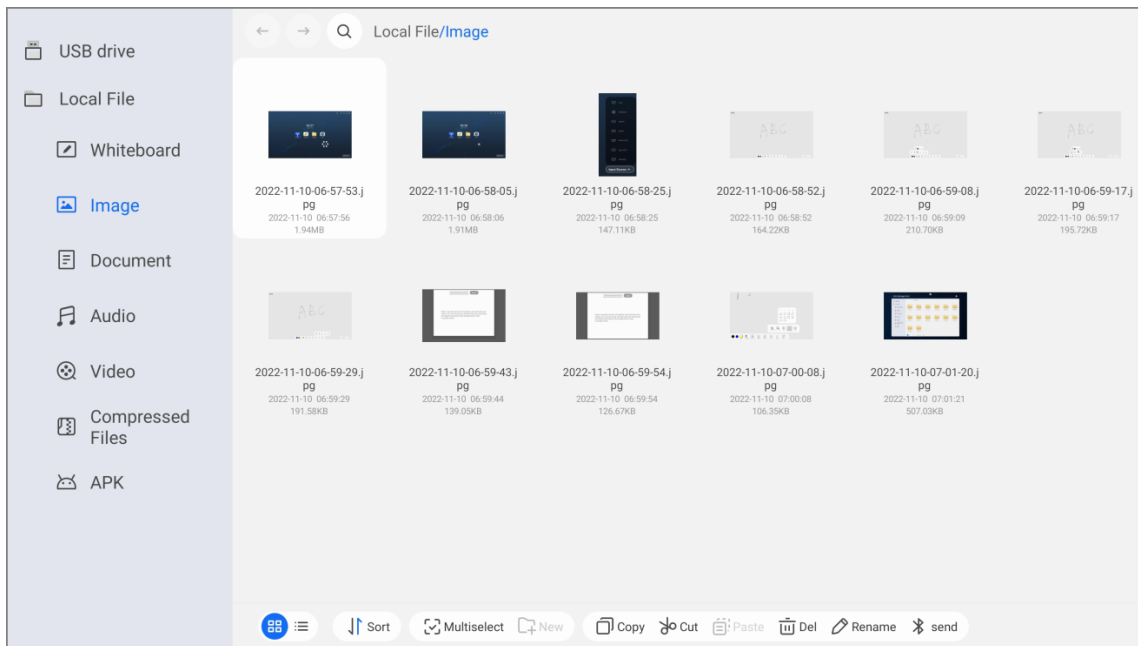

Table 3-5 File management icons

Icon	Description
	View local files on the previous or next screen.
	Enter file names to search for.
	Display files in thumbnail or list format.
Sort	Sort files in the ascending or descending order by name, size and time.
Multi-select	You can select multiple files or all the files.
New	Create a new folder.
Copy	Select a file or folder, tap Copy or Cut , and then tap Paste to paste the file or folder.
Cut	
Paste	
Delete	Delete files or folders.
Rename	Rename the files and folders. You cannot change the suffix of the file name.
Send	Send the selected information through Bluetooth.

3.4 Screen Sharing

You can remotely control the whiteboard on the phone, computer, or tablet, and project the content to the whiteboard screen. For details, see the corresponding user's manual.

3.5 Welcome Page

Prerequisites

Import the media such as images and audio files used to create the welcome page.

Procedure

- Step 1 Select **More** > **Welcome Page** on the home screen of the Android system.
- Step 2 Tap **Setting** on the lower-right corner to configure the welcome page.

Figure 3-6 Configure the welcome page

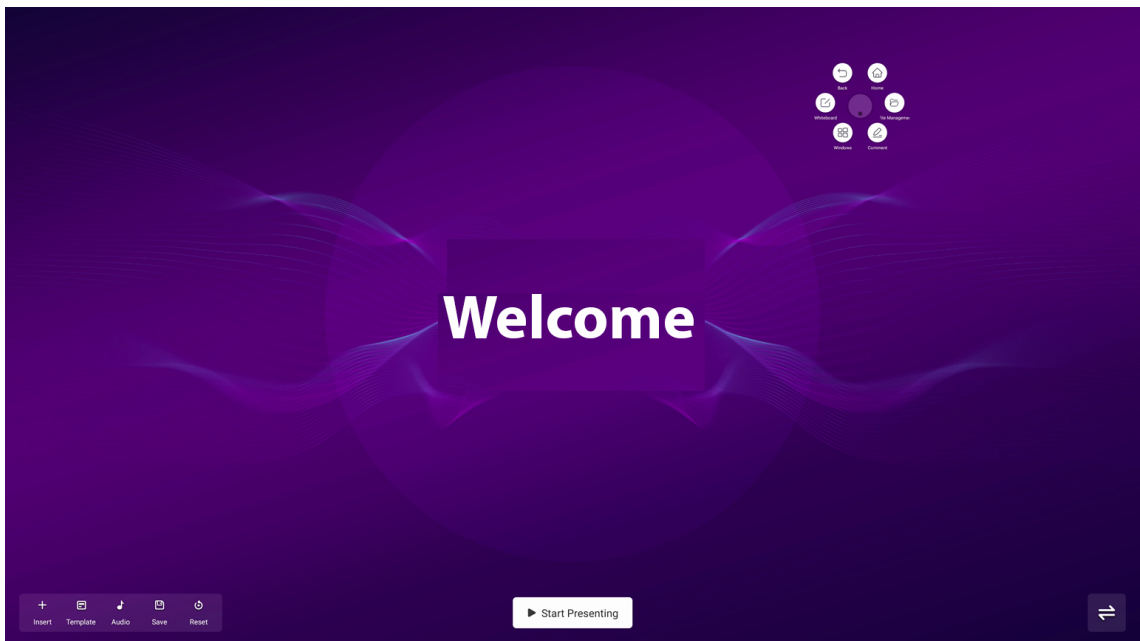

Table 3-6 Icon description

Icon	Description
	Change the position of the toolbar.
Insert	Insert a background image or other images and text.
Template	You can use local background template or custom template.
Audio	Insert audio.
Save	Save your configurations.
Restart	Restore the welcome page to the default template.
Start Presenting	Show the presentation effect of the welcome page.

- Step 3 Tap **Save**. You can swipe left on the home screen to view the welcome page.

3.6 System Settings

Configure network settings, general and advanced settings, and other system settings.

3.6.1 Configuring Network and Bluetooth Connection

On the home screen, tap **More** > **Settings** to configure the network and Bluetooth settings.



You can enable wireless network or wired network. Wireless network and wired network cannot be enabled at the same time. The whiteboard itself can also act as a hotspot to share network connection with other devices.

Figure 3-7 Network

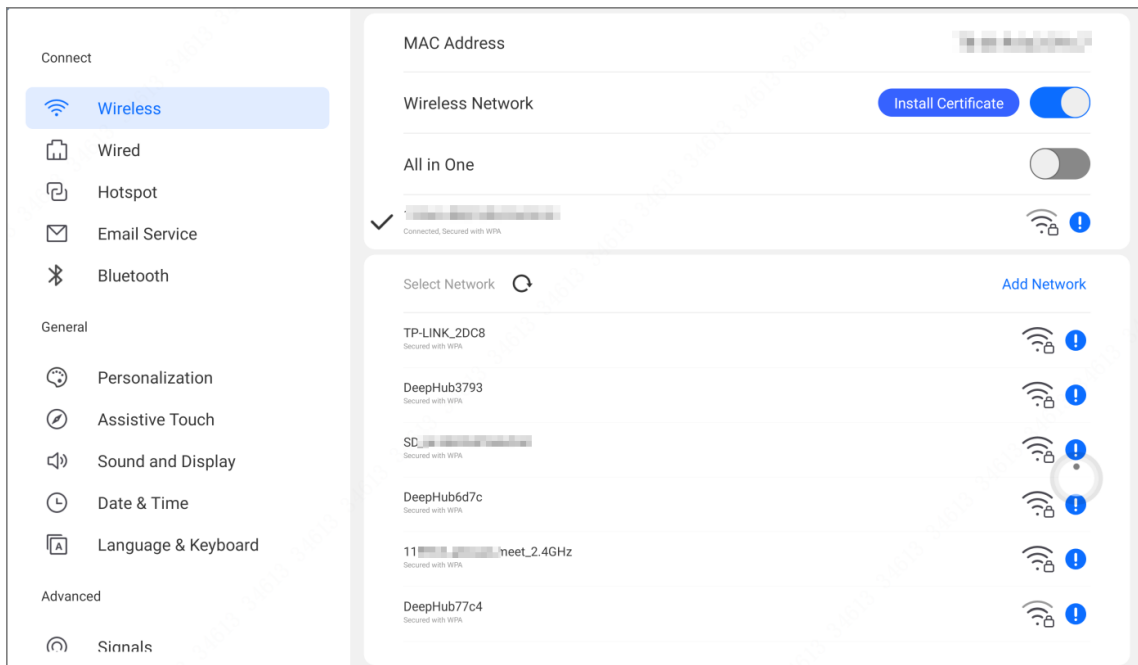



Table 3-7 Network parameters

Parameter	Description
Wireless	<p>Enable Wireless Network, and then the whiteboard can connect to an available Wi-Fi network in the area. To add a wireless network, tap Add Network, enter the SSID network name and password, and then configure advanced settings as needed.</p> <p></p> <p>We recommend you select a secure authentication method to connect to a wireless network.</p>

Parameter	Description
Wired	<p>Configure wired network connection parameters.</p> <ul style="list-style-type: none"> DHCP : When there is a DHCP server on the network, you can enable Wired, and then the whiteboard gets a dynamic IP address automatically.  When the connected network supports IPV6, the system displays the IPV4 and IPV6 configuration page. Static : Set IP address, subnet mask, default gateway and DNS manually for the whiteboard.
Hotspot	<p>Enable Hotspot, configure the network SSID and then enter the password. You can view hotspot name, hotspot password, encryption method, frequency band and other information.</p>
Email Service	<p>Configure the Email address, and then you can send files from the whiteboard to other Email addresses.</p>
Bluetooth	<p>Enable Bluetooth, and then the whiteboard can connect to an available Bluetooth in the area. Supports to connect wireless audio equipment, keyboards and more.</p>

3.6.2 Configuring General Settings

On the home screen, tap **More** > **Settings** to configure the general settings.

Figure 3-8 General settings

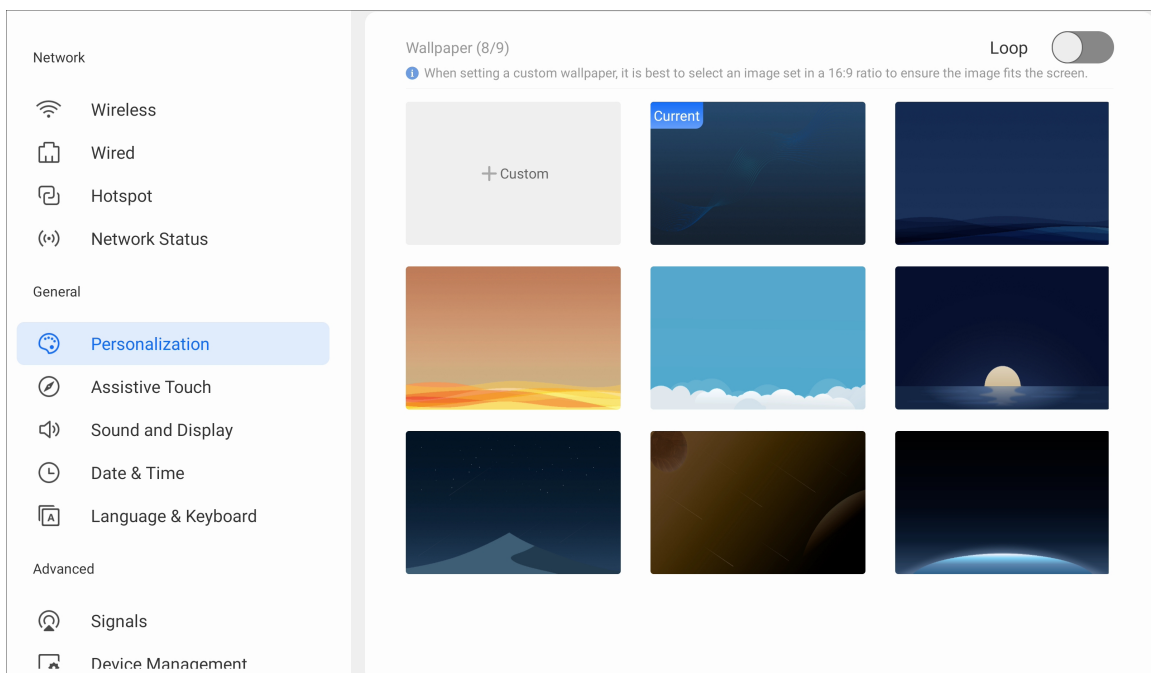



Table 3-8 General settings description

Parameter	Description
Personalization	<p>Set the background image, and you can enable Loop to play the selected background images in turn and customize the boot screen.</p> <ul style="list-style-type: none"> • The system provides 8 wallpapers by default. • You can also customize and upload wallpapers. The recommended image ratio is 16:9.
Assistive Touch	<p>Select or customize when the assistive touch is automatically hidden away, and the manner in which it is hidden (small circle or disappear).</p>  <p>After you enable the assistive touch, double-tap with two fingers to bring it up.</p>
Sound and Display	<ul style="list-style-type: none"> • Adjust the level of volume. If the volume is 0, a mute sign will be displayed at the lower-left corner of the screen. • Sound effect: You can select Standard, Music, Meeting and Theater. • System sound prompt: You can use the default audio or external audio. You can add up to 10 external audio files with each file smaller than 500 KB. • Brightness can be adjusted manually in the range of 1–100 or automatically according to the ambient brightness.
Date & Time	<p>Set the date and time automatically or manually. You can configure the format of the time, date and time zone.</p> <p>With Auto Sync Time enabled, the system time is synchronized with the server time. When it is disabled, you need to manually set the date and time.</p>
Language & Keyboard	<p>Select the system language and the input method.</p>

3.6.3 Configuring Advanced Parameters

On the home screen, tap **More** > **Settings** to configure the advanced parameters.

Figure 3-9 Advanced parameters

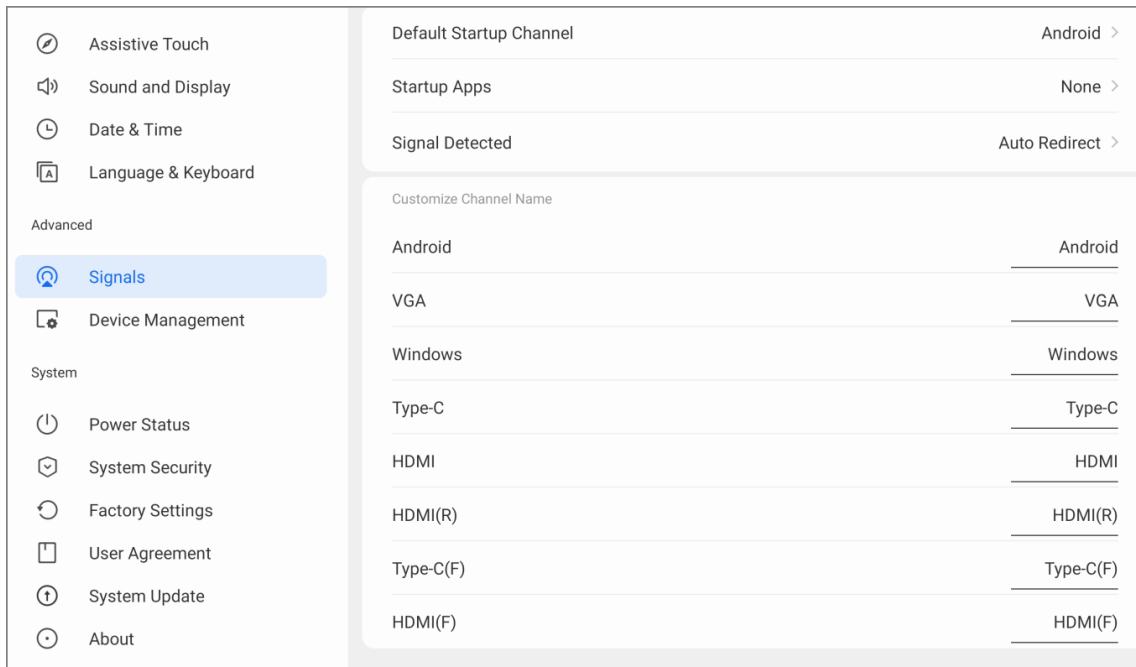



Table 3-9 Description of advanced parameters

Parameter	Description
Signals	<ul style="list-style-type: none"> ● Default Startup Channel : Select the channel to be enabled at startup. <ul style="list-style-type: none"> ◇ Fixed channel: Access a fixed channel after startup. ◇ Memory channel: Access the channel of the last startup. ● Startup Application : Select an application that is on the whiteboard to be opened every time the system starts. ● Signal Detected : <ul style="list-style-type: none"> ◇ Auto Redirect : Connect to the signal source and automatically redirect to the corresponding channel. ◇ Pop-up Window : When a signal source is connected, a pop-up window appears asking whether to jump to the connected source channel. ● Customize Channel Name : Customize the channel name. After the name is modified, the corresponding channel name of the whole system will be modified synchronously.

Parameter	Description
Device Management	<ul style="list-style-type: none"> ● View information on the camera, microphone, and speaker.  <p>Enable Mic Boost, you can increase the volume of the microphone.</p> ● HDMI OUT : The function is available after the whiteboard is connected to a monitor through the HDMI OUT port. After you enable HDMI OUT, the whiteboard outputs signals at the maximum resolution of the monitor by default. You can select different resolutions depending on the capacity of the monitor. ● Pick-up Pen Detection : After you enable the function, when you pick up a stylus pen from the pen attaching area at the bottom of the whiteboard, the system pops up a window and prompts you to open electronic whiteboard or enter annotation mode.  <ul style="list-style-type: none"> ◇ The system does no give pick-up pen prompt during the setup wizard and update. ◇ Pick-up Pen Detection is available on select models. ● RS-232 Control : With RS-232 Control enabled, you can connect the whiteboard to the RS-232 transparent debugging serial port for data transmission between devices. ● IR Frame Version : Tap Update to update the version of the IR frame.

3.6.4 Configuring System Parameters

On the home screen, tap **More** > **Settings** to configure the system parameters.

Figure 3-10 System parameters

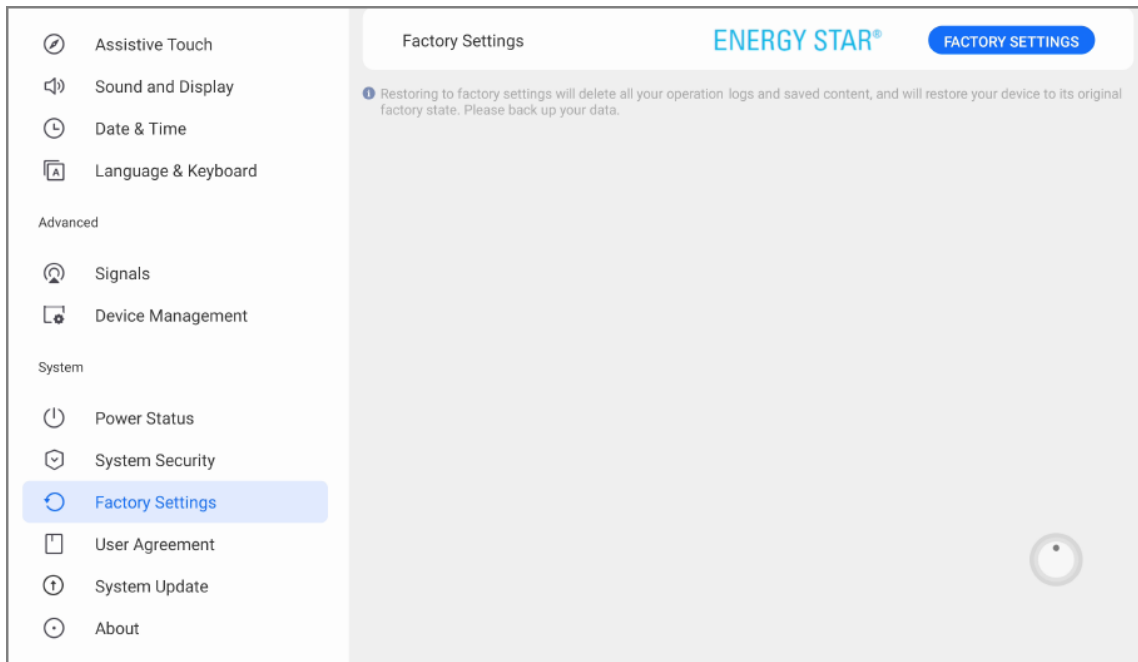





Table 3-10 System parameter description

Parameter	Description
Power Status	<p>Set the startup and shutdown functions of the whiteboard.</p> <ul style="list-style-type: none"> ● Startup Options : Select standby after power on or startup after power on (default). ● Screen Off: Offers always on and no operation after 1 min, 5 min and 10 min. It also has custom configuration from 1 to 60 min and shut down after 10 minutes without operation (ENERGY STAR). ● Temperature Detection : After you enable the function,  appears on the upper-right corner of the home screen. When the temperature of CPU is higher than 80 °C, the icon becomes orange. When the CPU temperature is higher than 90 °C, the icon becomes red. ● Scheduled Startup/Shutdown (Max. 10 plans): Tap Add Plan to set when to automatically power on and off the system. Tap  to delete the plan.

Parameter	Description
System Security	<ul style="list-style-type: none"> ● Pin : After enabling Pin, you can unlock the whiteboard with digital password. ● Unlock Pattern : After enabling Unlock Pattern, you can unlock the whiteboard by drawing a pattern. ● Lock Screen : Tap Lock screen, and then select a screen lock option, including no operation after 1 min, 5 min and 10 min, and custom configuration. ● Touch Lock : After enabling touch lock, you cannot use touch control on the screen. Press the power button 3 times in 2 seconds to unlock the touch lock. ● USB Permission : If this function is enabled, the system does not detect the access of USB devices.  <ul style="list-style-type: none"> ● The system does not support the simultaneous use of pattern password and digital password. ● The password cannot be retrieved. Keep your password safe. If you forgot the password, contact out customer support. ● Fingerprint is available on select models.
Factory Settings	Tap FACTORY SETTINGS , and all your operation records and saved content will be deleted. The whiteboard will also be restored to its factory settings.
User Agreement	View the privacy policy, software license agreement, and open source agreement.
System Update	View the current system version. When the whiteboard is connected to a network, tap CHECK FOR UPDATES to check whether there is a new version available.
About	View MAC address, device serial number, device name (can be edited), running memory, storage space, resolution, system version, Android version, and security baseline version.  <ul style="list-style-type: none"> ● The device name can consist of up to 31 characters and contain letters, numbers, and special characters (-@).

4 Shutdown

After the whiteboard is turned on, press and hold the power button for 5 s, and then the system will prompt you whether to shut down the whiteboard. Tap **OK** to shut down the whiteboard.



The whiteboard provides power-off protection to the computer module. After you shut down the whiteboard, the computer module will shut down a little while afterwards.

5 System Update

You can update the system online or through USB.



Please be advised that downgrading to a lower version will make the whiteboard vulnerable to security attacks.

5.1 Online Update

After the whiteboard is registered to the cloud management platform, the platform can send the update package to the whiteboard.

Prerequisites

- Make sure that the whiteboard is connected to the network.
- Make sure that you have enabled OTA platform in **More > Settings > System Update**.

Procedure

- Step 1 On the home screen, select **More > Settings > System Upgrade**.
- Step 2 Tap **CHECK FOR UPDATES**.
- Step 3 When the system detects that a newer version available, tap **Download** to download the update package.
- Step 4 After the package is downloaded, you can select to install the package immediately. After it updates, the whiteboard restarts automatically.

5.2 Update through USB

You can upload update.zip file into a USB flash drive and then use the update file to update the system.

Prerequisites

Get the update package from the technical support.

Procedure

- Step 1 Change the name of the update package to update.zip, and then save the file to the root directory of the USB flash drive.
- Step 2 With whiteboard turned on, plug the USB flash drive into the USB port of the whiteboard.



Update the system with a USB flash drive in the FAT 32 format. Otherwise, update might fail.

- Step 3 When the system prompts whether to update immediately, tap **Upgrade**. The update begins. After it updates, the whiteboard restarts automatically.

6 FAQ

1. **The whiteboard shuts down automatically.**

- Check whether you have enabled the sleep function. You can refer to the regular computer troubleshooting procedure.
- Check the channel of the input source. If there is no signal, the whiteboard will shut down automatically.
- Check whether the power supply is stable.

2. **The indicator light is off.**

- Check whether the power supply is normal.
- Check whether the rocker switch of the whiteboard is turned on.

3. **Missing or abnormal colors.**

If the whiteboard is connected to a computer, check whether the HDMI cable is intact and correctly connected.

4. **The image is not displayed in full screen or part of the image is outside the screen.**

- Check whether the resolution is 16:9.
- If the whiteboard is connected to an external computer, unplug the HDMI cable and then plug it back in.

5. **The whiteboard displays images but has no sound.**

- Adjust the volume.
- If the whiteboard is connected to a computer, check whether the audio cable is correctly connected.

6. **Touch response is poor and the location that responds is not accurate.**

- Check whether other objects such as paper or your sleeves are in contact with the screen.
- Check whether the resolution is 16:9.

7. **Touch control is not working.**

If the whiteboard is connected to a computer, check whether the TOUCH port of the whiteboard is correctly connected to the USB port of the computer.

8. **After you connect the computer with the whiteboard through the Type C port on the front panel, unable to control the computer through touch operations on the whiteboard.**

- Change another Type C cable.
- Use the TOUCH port on the rear panel.

Appendix 1 Touch Operation

You can use the stylus pen or directly use your fingers to operate the device screen.



This section uses operation with stylus pen as an example.

Appendix Table 1-1 Touch operations

Operation	Description
Tap	Tap the screen once with the stylus pen.
Double-tap	Tap the screen twice with the stylus pen (The time gap between the taps is around 0.5 s).
Context menu	Slightly touch the screen for 1 to 2 seconds with the stylus pen. Lift the stylus pen when there is a circle on the screen, and then the context menu is displayed.
Drag	Hold the icon that needs to be dragged with the stylus pen and then move the stylus pen to the target place. Lift the stylus pen to drop the item.
Slide	Hold the screen (such as the slider that is used for the web browser) that you want to slide with the stylus pen, and then slide the stylus pen toward the direction you want. Lift the stylus pen to release the screen.
Zoom	Use the stylus pen to press and hold the window (such as the web pages and images), and then use another stylus pen to drag the window to zoom in and zoom out.

Appendix 2 Security Commitment and Recommendation

Dahua Vision Technology Co., Ltd. (hereinafter referred to as "Dahua") attaches great importance to cybersecurity and privacy protection, and continues to invest special funds to comprehensively improve the security awareness and capabilities of Dahua employees and provide adequate security for products. Dahua has established a professional security team to provide full life cycle security empowerment and control for product design, development, testing, production, delivery and maintenance. While adhering to the principle of minimizing data collection, minimizing services, prohibiting backdoor implantation, and removing unnecessary and insecure services (such as Telnet), Dahua products continue to introduce innovative security technologies, and strive to improve the product security assurance capabilities, providing global users with security alarm and 24/7 security incident response services to better protect users' security rights and interests. At the same time, Dahua encourages users, partners, suppliers, government agencies, industry organizations and independent researchers to report any potential risks or vulnerabilities discovered on Dahua devices to Dahua PSIRT, for specific reporting methods, please refer to the cyber security section of Dahua official website.

Product security requires not only the continuous attention and efforts of manufacturers in R&D, production, and delivery, but also the active participation of users that can help improve the environment and methods of product usage, so as to better ensure the security of products after they are put into use. For this reason, we recommend that users safely use the device, including but not limited to:

Account Management

1. Use complex passwords

Please refer to the following suggestions to set passwords:

- The length should not be less than 8 characters;
- Include at least two types of characters: upper and lower case letters, numbers and symbols;
- Do not contain the account name or the account name in reverse order;
- Do not use continuous characters, such as 123, abc, etc.;
- Do not use repeating characters, such as 111, aaa, etc.

2. Change passwords periodically

It is recommended to periodically change the device password to reduce the risk of being guessed or cracked.

3. Allocate accounts and permissions appropriately

Appropriately add users based on service and management requirements and assign minimum permission sets to users.

4. Enable account lockout function

The account lockout function is enabled by default. You are advised to keep it enabled to protect account security. After multiple failed password attempts, the corresponding account and source IP address will be locked.

5. Set and update password reset information in a timely manner

Dahua device supports password reset function. To reduce the risk of this function being used by threat actors, if there is any change in the information, please modify it in time. When setting security questions, it is recommended not to use easily guessed answers.

Service Configuration

1. Enable HTTPS

It is recommended that you enable HTTPS to access Web services through secure channels.

2. Encrypted transmission of audio and video

If your audio and video data contents are very important or sensitive, we recommend you to use encrypted transmission function in order to reduce the risk of your audio and video data being eavesdropped during transmission.

3. Turn off non-essential services and use safe mode

If not needed, it is recommended to turn off some services such as SSH, SNMP, SMTP, UPnP, AP hotspot etc., to reduce the attack surfaces.

If necessary, it is highly recommended to choose safe modes, including but not limited to the following services:

- SNMP: Choose SNMP v3, and set up strong encryption and authentication passwords.
- SMTP: Choose TLS to access mailbox server.
- FTP: Choose SFTP, and set up complex passwords.
- AP hotspot: Choose WPA2-PSK encryption mode, and set up complex passwords.

4. Change HTTP and other default service ports

It is recommended that you change the default port of HTTP and other services to any port between 1024 and 65535 to reduce the risk of being guessed by threat actors.

Network Configuration

1. Enable Allow list

It is recommended that you turn on the allow list function, and only allow IP in the allow list to access the device. Therefore, please be sure to add your computer IP address and supporting device IP address to the allow list.

2. MAC address binding

It is recommended that you bind the IP address of the gateway to the MAC address on the device to reduce the risk of ARP spoofing.

3. Build a secure network environment

In order to better ensure the security of devices and reduce potential cyber risks, the following are recommended:

- Disable the port mapping function of the router to avoid direct access to the intranet devices from external network;
- According to the actual network needs, partition the network: if there is no communication demand between the two subnets, it is recommended to use VLAN, gateway and other methods to partition the network to achieve network isolation;
- Establish 802.1x access authentication system to reduce the risk of illegal terminal access to the private network.

Security Auditing

1. Check online users

It is recommended to check online users regularly to identify illegal users.

2. Check device log

By viewing logs, you can learn about the IP addresses that attempt to log in to the device and key operations of the logged users.

3. **Configure network log**

Due to the limited storage capacity of devices, the stored log is limited. If you need to save the log for a long time, it is recommended to enable the network log function to ensure that the critical logs are synchronized to the network log server for tracing.

Software Security

1. **Update firmware in time**

According to the industry standard operating specifications, the firmware of devices needs to be updated to the latest version in time in order to ensure that the device has the latest functions and security. If the device is connected to the public network, it is recommended to enable the online upgrade automatic detection function, so as to obtain the firmware update information released by the manufacturer in a timely manner.

2. **Update client software in time**

We recommend you to download and use the latest client software.

Physical Protection

It is recommended that you carry out physical protection for devices (especially storage devices), such as placing the device in a dedicated machine room and cabinet, and having access control and key management in place to prevent unauthorized personnel from damaging hardware and other peripheral equipment (e.g. USB flash disk, serial port).

ENABLING A SMARTER SOCIETY AND BETTER LIVING

ZHEJIANG DAHUA VISION TECHNOLOGY CO., LTD.

Address: No. 1399, Binxing Road, Binjiang District, Hangzhou, P. R. China | Website: www.dahuasecurity.com | Postcode: 310053

Email: dhoverseas@dhvisiontech.com | Tel: +86-571-87688888 28933188