



**THE DISPLAY CHOICE  
OF PROFESSIONALS™**

**QM-4302, QM-5502 & QM-6502 LCD Display**

# **User Manual**

[www.agneovo.com](http://www.agneovo.com)

# TABLE OF CONTENTS

<b>SAFETY INFORMATION</b> .....	<b>1</b>
Federal Communications Commission (FCC) Notice (U.S. Only).....	1
WEEE.....	2
<b>PRECAUTIONS</b> .....	<b>3</b>
Cautions When Setting Up.....	3
Cautions When Using.....	4
Cleaning and Maintenance.....	4
Notice for the LCD Display.....	5
<b>CHAPTER 1: PRODUCT DESCRIPTION</b> .....	<b>6</b>
1.1 Unpacking.....	6
1.2 Package Contents.....	6
1.3 Preparing for the Installation.....	7
1.4 Wall Mounting Installation.....	7
1.4.2 Ventilation Requirements for Enclosure Locating.....	8
1.4.1 VESA Grid.....	8
1.5 LCD Display Overview.....	9
1.5.1 Control Panel.....	9
1.5.2 Input/Output Terminals.....	10
1.6 Remote Control.....	11
1.6.1 General Functions.....	11
1.6.2 ID Remote Control.....	12
1.6.3 Inserting the Batteries in the Remote Control.....	13
1.6.4 Handling the Remote Control.....	13
1.6.5 Operating Range of the Remote Control.....	13
<b>CHAPTER 2: MAKING CONNECTIONS</b> .....	<b>14</b>
<b>CHAPTER 3: ON SCREEN DISPLAY MENU</b> .....	<b>15</b>
3.1 Using the OSD Menu.....	15
3.2 OSD Menu Tree.....	17
<b>CHAPTER 4: ADJUSTING THE LCD DISPLAY</b> .....	<b>18</b>
4.1 Picture Settings.....	18
4.2 Audio Settings.....	20
4.3 Setup Settings.....	21
<b>CHAPTER 5: MULTIMEDIA</b> .....	<b>26</b>
5.1 Overview.....	26
5.2 Supported Format.....	26
5.4 Play Mode.....	27
5.5 Order to Play Files.....	27
5.6 Detail of Each Screen.....	28
5.7 AutoPlay.....	29

# TABLE OF CONTENTS

<b>CHAPTER 6: APPENDIX .....</b>	<b>30</b>
6.1 Warning Messages.....	30
6.2 Input Mode .....	31
6.3 Cleaning .....	33
6.4 Troubleshooting.....	34
<b>CHAPTER 7: SPECIFICATIONS .....</b>	<b>35</b>
7.1 Display Specifications .....	35
7.2 Display Dimensions.....	36

# SAFETY INFORMATION

## Federal Communications Commission (FCC) Notice (U.S. Only)



This equipment has been tested and found to comply with the limits for a Class A digital device, pursuant to part 15 of the FCC Rules. These limits are designed to provide reasonable protection against harmful interference when the equipment is operated in a commercial environment. This equipment generates, uses, and can radiate radio frequency energy and, if not installed and used in accordance with the instruction manual, may cause harmful interference to radio communications. Operation of this equipment in a residential area is likely to cause harmful interference in which case the user will be required to correct the interference at his own expense.



Changes or modifications not expressly approved by the party responsible for compliance could void the user's authority to operate the equipment.

Use only an RF shielded cable that was supplied with the display when connecting this display to a computer device.

To prevent damage which may result in fire or shock hazard, do not expose this appliance to rain or excessive moisture.

THIS CLASS A DIGITAL APPARATUS MEETS ALL REQUIREMENTS OF THE CANADIAN INTERFERENCE CAUSING EQUIPMENT REGULATIONS.

## CE



**WARNING:** This equipment is compliant with Class A of EN55032/CISPR 32. In a residential environment this equipment may cause radio interference.

# SAFETY INFORMATION

## Waste Electrical and Electronic Equipment-WEEE

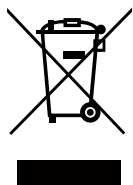

This symbol on the product or on its packaging indicates that this product must not be disposed of with your other household waste. Instead, it is your responsibility to dispose of your waste equipment by handing it over to a designated collection point for the recycling of waste electrical and electronic equipment. The separate collection and recycling of your waste equipment at the time of disposal will help to conserve natural resources and ensure that it is recycled in a manner that protects human health and the environment. For more information about where you can drop off your waste equipment for recycling, please contact your local city office, your household waste disposal service or the shop where you purchased the product

For Private Households in the European Union. To help conserve natural resources and ensure the product is recycled in a manner that protects human health and the environment, we would like to bring your attention to the following:

- The crossed-out dustbin on the device or outer packaging indicates the product is compliant with European WEEE (Waste Electrical and Electronic Equipment) Directive
- Always dispose of the old devices separately from household waste
- Batteries should be removed beforehand and disposed separately to the right collection system
- You are responsible with regard to the deletion of personal data on old devices before disposal
- Private households can hand in their old devices free of charge
- For more information about where you can drop off your waste equipment for recycling, please contact your local city office, your household waste disposal service or the shop where you purchased the product

## Turkey RoHS

Türkiye Cumhuriyeti: EEE Yönetmeliğine Uygundur.

## Ukraine RoHS

Обладнання відповідає вимогам Технічного регламенту щодо обмеження використання деяких небезпечних речовин в електричному та електронному обладнанні, затвердженого постановою Кабінету Міністрів України від 3 грудня 2008 № 1057.

# PRECAUTIONS

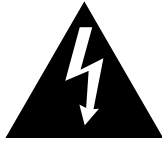

## Symbols used in this manual

	This icon indicates the existence of a potential hazard that could result in personal injury or damage to the product.
	This icon indicates important operating and servicing information.

## Notice

- Read this User Manual carefully before using the LCD display and keep it for future reference.
- The product specifications and other information provided in this User Manual are for reference only. All information is subject to change without notice. Updated content can be downloaded from our web site at [www.agneovo.com](http://www.agneovo.com).
- To protect your rights as a consumer, do not remove any stickers from the LCD display. Doing so may affect the determination of the warranty period.

## Cautions When Setting Up

- Do not place the LCD display near heat sources, such as a heater, exhaust vent, or in direct sunlight.
- Do not cover or block the ventilation holes in the housing.
- Place the LCD display on a stable area. Do not place the LCD display where it may subject to vibration or shock.
- Place the LCD display in a well-ventilated area.
- Do not place the LCD display outdoors.
- To avoid the risk of shock or permanent damage to the set, do not expose the display to dust, rain, water or an excessively moist environment.
- Do not spill liquid or insert sharp objects into the LCD display through the ventilation holes. Doing so may cause accidental fire, electric shock or damage the LCD display.

# PRECAUTIONS

## Cautions When Using

- Use only the power cord supplied with the LCD display.
- The power outlet should be installed near the LCD display and be easily accessible.
- If an extension cord is used with the LCD display, ensure that the total current consumption plugged into the power outlet does not exceed the ampere rating.
- Do not allow anything to rest on the power cord. Do not place the LCD display where the power cord may be stepped on.
- If the LCD display will not be used for an indefinite period of time, unplug the power cord from the power outlet.
- To disconnect the power cord, grasp and pull by the plug head. Do not tug on the cord; doing so may cause fire or electric shock.
- Do not unplug or touch the power cord with wet hands.
- When turning off the display by detaching the power cord, wait 6 seconds before re-attaching the power cord for normal operation.
- Do not knock or drop the display during operation or transportation.

## Cleaning and Maintenance

- To protect your display from possible damage, do not put excessive pressure on the LCD panel. When moving your display, grasp the frame to lift; do not lift the display by placing your hand or fingers on the LCD panel.
- Unplug the display if you need to clean it with a slightly damp cloth. The screen may be wiped with a dry cloth when the power is off. However, never use organic solvent, such as, alcohol, or ammonia-based liquids to clean your display.
- If your display becomes wet, wipe it with dry cloth as soon as possible.
- If a foreign substance or water gets in your display, turn the power off immediately and disconnect the power cord. Then remove the foreign substance or water, and send the unit to the maintenance center.
- In order to maintain the best performance of your display and ensure a longer lifetime, we strongly recommend using the display in a location that falls within the following temperature and humidity ranges.
  - ◆ Temperature: 0-40°C (32-104°F)
  - ◆ Humidity: 20-80% RH



### Warning:



Unplug the power cord from the power outlet and refer to qualified service

personnel under the following conditions:

- ◆ When the power cord is damaged.
- ◆ If the LCD display has been dropped or the housing has been damaged.
- ◆ If the LCD display emits smoke or a distinct odor.

# PRECAUTIONS

## Notice for the LCD Display

- In order to maintain the stable luminous performance, it is recommended to use low brightness setting.
- Due to the lifespan of the lamp, it is normal that the brightness quality of the LCD display may decrease with time.
- When static images are displayed for long periods of time, the image may cause an imprint on the LCD display. This is called image retention or burn-in.
  - ◆ To prevent image retention, do any of the following:
    - Set the LCD display to turn off after a few minutes of being idle.
    - Use a screen saver that has moving graphics or a blank white image.
    - Execute the ANTI-BURN-IN function of the LCD display. See **SETUP > ANTI-BURN-IN** section.
    - Switch desktop backgrounds regularly.
    - Adjust the LCD display to low brightness settings.
    - Turn off the LCD display when the system is not in use.
  - ◆ Things to do when the LCD display shows image retention:
    - Turn off the LCD display for extended periods of time. It can be several hours or several days.
    - Use a screen saver and run it for extended periods of time.
    - Use a black and white image and run it for extended periods of time.
- There are millions of micro transistors inside the LCD display. It is normal for a few transistors to be damaged and to produce spots. This is acceptable and is not considered a failure.
- **IMPORTANT:** Always activate a moving screen saver program when you leave your display unattended. Always activate a periodic screen refresh application if the unit will display unchanging static content. Uninterrupted display of still or static images over an extended period may cause “burn in”, also known as “after-imaging” or “ghost imaging”, on your screen. This is a well-known phenomenon in LCD panel technology. In most cases, the “burned in” or “after-imaging” or “ghost imaging” will disappear gradually over a period of time after the power has been switched off.
- **WARNING:** Severe “burn-in” or “after-image” or “ghost image” symptoms will not disappear and cannot be repaired. This is also not covered under the terms of your warranty.



# CHAPTER 1: PRODUCT DESCRIPTION

## 1.1 Unpacking

- This product is packed in a packaging box which contains standard accessories.
- Any other optional accessories will be packed separately.
- Considering the size and weight of the display, it is recommended that this product is carried out by two persons.
- After opening the packaging box, ensure that the included items are in good condition and complete.

## 1.2 Package Contents

When unpacking, check if the following items are included in the package. If any of them is missing or damaged, contact your dealer.

LCD Display



Remote control

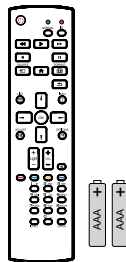

Quick Start Guide



HDMI cable

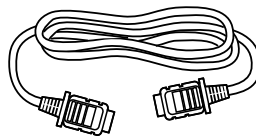

Power cord

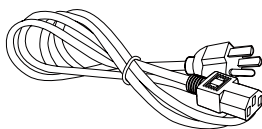

AAA Batteries x2



### Note:

- ◆ Remote control is shipped with the supplied AAA batteries.
- ◆ For all other regions, apply a power cord that conforms to the AC voltage of the power socket and has been approved by and complies with the safety regulations of the particular country (Type H05VV-F, 3G, 0.75mm<sup>2</sup> should be used).
- ◆ You might like to save the package box and packing material for shipping the display.
- ◆ The pictures are for reference only. Actual items may vary upon shipment.

# PRODUCT DESCRIPTION

## 1.3 Preparing for the Installation

- Due to the high power consumption, always use the plug exclusively designed for this product. If an extended line is required, please consult your service agent.
- The product should be installed on a flat surface to avoid tipping. The distance between the back of the product and the wall should be maintained for proper ventilation. Avoid installing the product in the kitchen, bathroom or any other places with high humidity so as not to shorten the service life of the electronic components.
- The product can normally operate only under 3000m in altitude. In installations at altitudes above 3000m, some abnormalities may be experienced.

## 1.4 Wall Mounting Installation

To mount this display to a wall, you will have to obtain a standard wall-mounting kit (commercially available).

To wall-mount the LCD display, screw the mounting bracket to the VESA holes at the rear of the LCD display.

### QM-4302

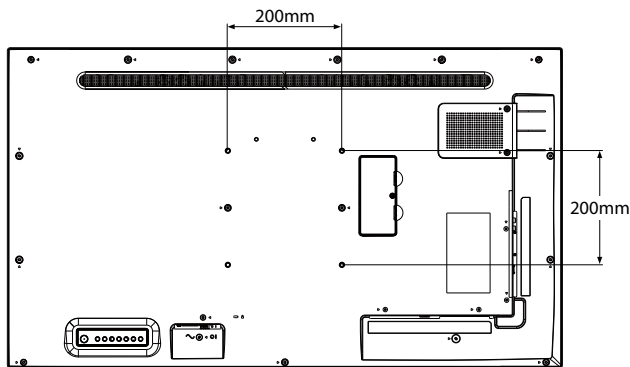

### QM-5502

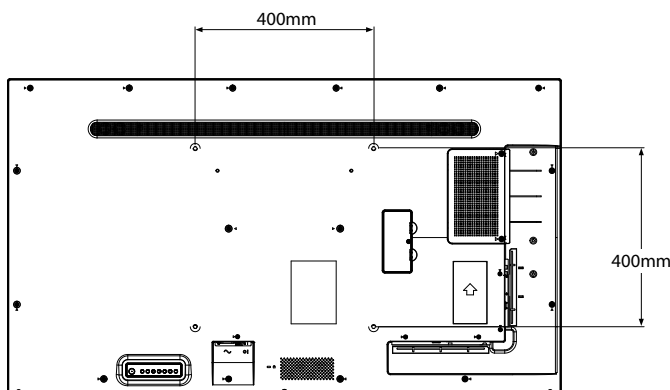

### Warning:

- ◆ Do not press too hard on the LCD panel or edge of the frame, as this may cause the device to malfunction.

### Note:

- ◆ Avoid the wall-mounting kit to block the ventilation holes on the back of the display.
- ◆ Secure the LCD display on a solid wall strong enough to bear its weight.
- ◆ Lay a protective sheet on a table, which was wrapped around the display when it was packaged, beneath the screen surface so as not to scratch the screen face.
- ◆ Ensure you have all accessories for mounting this display (wall mount, ceiling mount, etc).
- ◆ Follow the instructions that come with the base mounting kit. Failure to follow correct mounting procedures could result in damage to the equipment or injury to the user or installer. Product warranty does not cover damage caused by improper installation.

# PRODUCT DESCRIPTION

## QM-6502

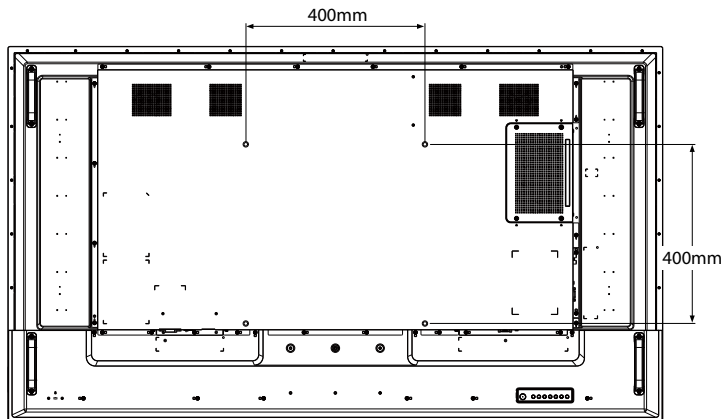

### 1.4.1 VESA Grid

Model Name	VESA Grid
QM-4302	200(W) x 200(H)mm
QM-5502	400(W) x 400(H)mm
QM-6502	400(W) x 400(H)mm

#### Caution:

To prevent the display from falling:

- ◆ For wall or ceiling installation, we recommend installing the display with metal brackets which are commercially available. For detailed installation instructions, see the guide received with the respective bracket.
- ◆ To lessen the probability of injury and damage resulting from fall of the display in case of earthquake or other natural disaster, be sure to consult the bracket manufacturer for installation location.

### 1.4.2 Ventilation Requirements for Enclosure Locating

To allow heat to disperse, leave space between surrounding objects as shown in the diagram below.

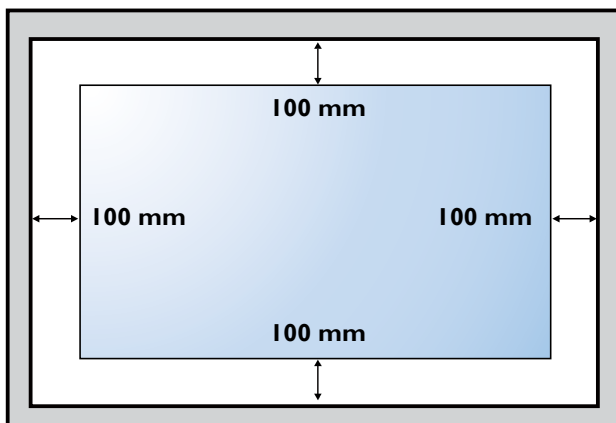

#### Note:

- ◆ For the wall-mounting kit, use M6 mounting screws (having a length 10 mm longer than the thickness of the mounting bracket) and tighten them securely.

# PRODUCT DESCRIPTION

## 1.5 LCD Display Overview

### 1.5.1 Control Panel

QM-4302

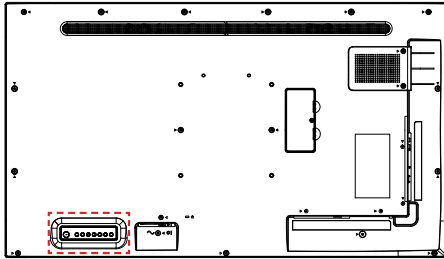

QM-5502

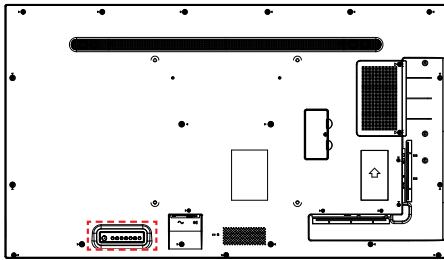

QM-6502

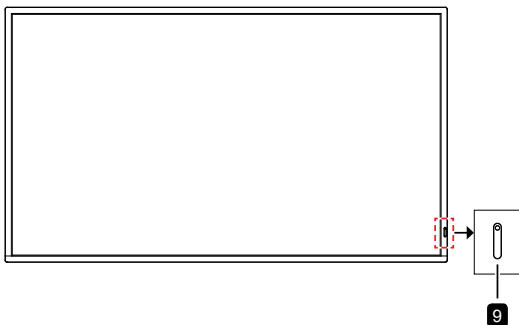
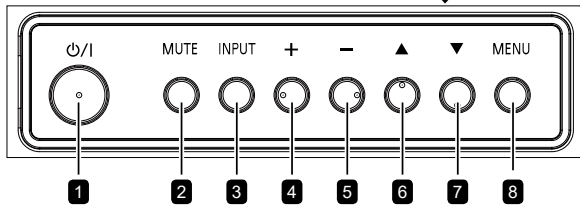
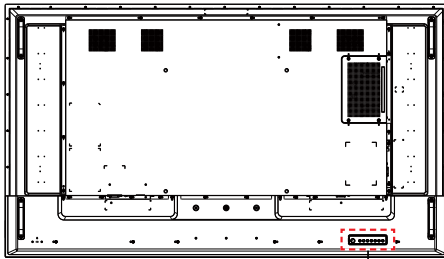

#### 1 [⏻] Power

Turn the display on or put the display to standby.

#### 2 MUTE

- Switch the audio mute ON/OFF.
- Return to the main menu screen while OSD menu is on.

#### 3 INPUT

Choose the input source.

#### 4 [+] Increase

- Select an option or adjust the settings while OSD menu is on.
- Increase the audio output level while OSD menu is off.

#### 5 [-] Decrease

- Enter the submenu, select an option, or adjust the settings while OSD menu is on.
- Decrease the audio output level while OSD menu is off.

#### 6 [▲] Up

Move the highlight bar up to select an option.

#### 7 [▼] Down

Move the highlight bar down to select an option.

#### 8 MENU

- Activate the OSD menu when OSD menu is off.
- Hide the OSD menu while OSD menu is on.

#### 9 Remote control sensor and power status indicator

- Receive command signals from the remote control.
- Indicate the operating status of the display.

### Power Status Indicator

Display State	Lighting State	State
During operation	Green lighting	Normal status(power on)
Waiting signal input	Green flashing every 1 second	Signal standby mode(Ex. DPMS/DMPM)
Waiting powering on(standby)	Amber lighting	Standby mode(DC off)
Waiting powering on (with schedule)	Green and amber flashing alternately every 1 second	Standby mode with enabled schedule
At abnormal temperature	Green and green flashing alternately every 1 second	At abnormal temperature

# PRODUCT DESCRIPTION

## 1.5.2 Input/Output Terminals

QM-4302

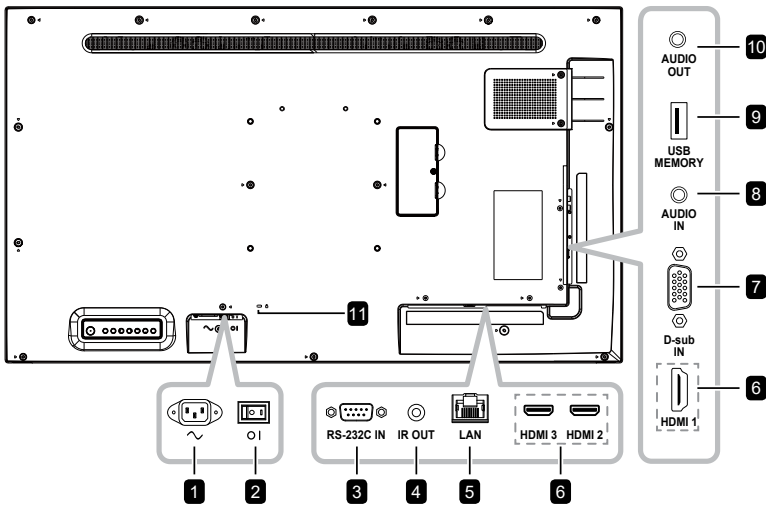

QM-5502

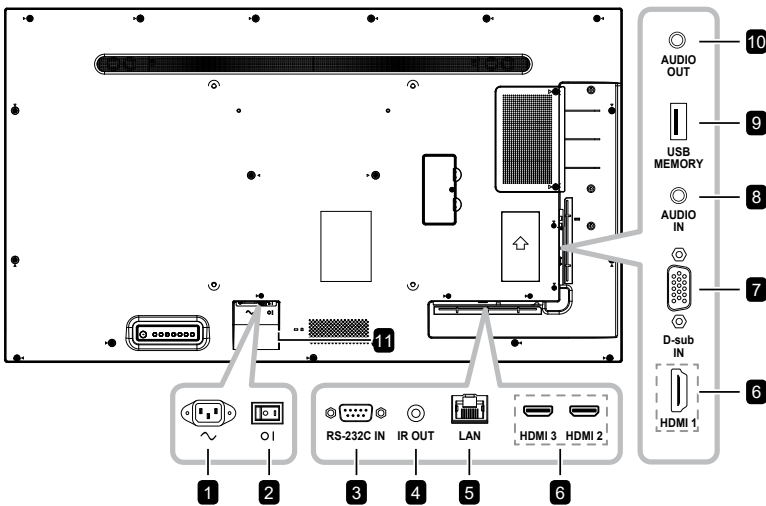

QM-6502

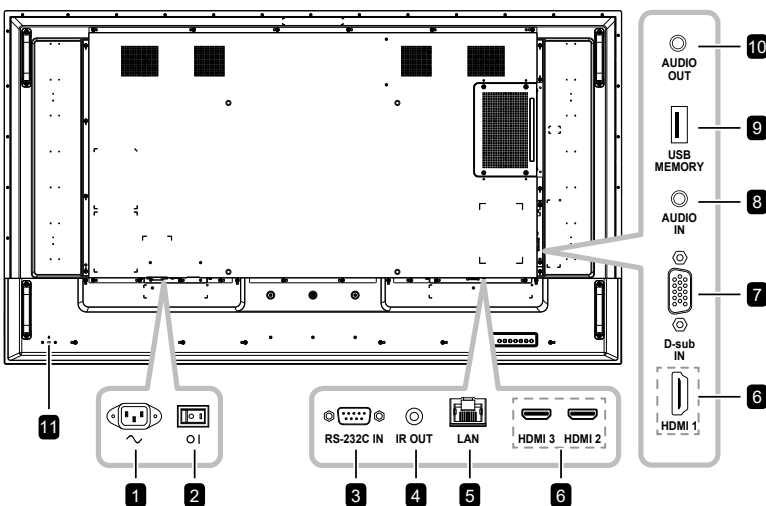

- 1 AC IN**  
AC power input.
- 2 Main power switch**  
Switch the main power on/off.
- 3 RS232 IN**  
Connect RS232 input from external equipment.
- 4 IR OUT**  
IR signal output for the loop-through function.
- 5 LAN**  
LAN control function for the use of remote control signal from the control center.
- 6 HDMI1/HDMI2/HDMI3 IN**  
Connect HDMI signals input.
- 7 D-Sub IN**  
Connect VGA signals input.
- 8 AUDIO IN**  
Connect audio signals input (3.5 mm Stereo Audio Jack).
- 9 USB 2.0**  
Connect USB 2.0 for service and media playback.
- 10 AUDIO OUT**  
Connect audio signals output (RCA Stereo Audio Jack).
- 11 SECURITY LOCK**  
Used for security and theft prevention.

# PRODUCT DESCRIPTION

## 1.6 Remote Control

### 1.6.1 General Functions

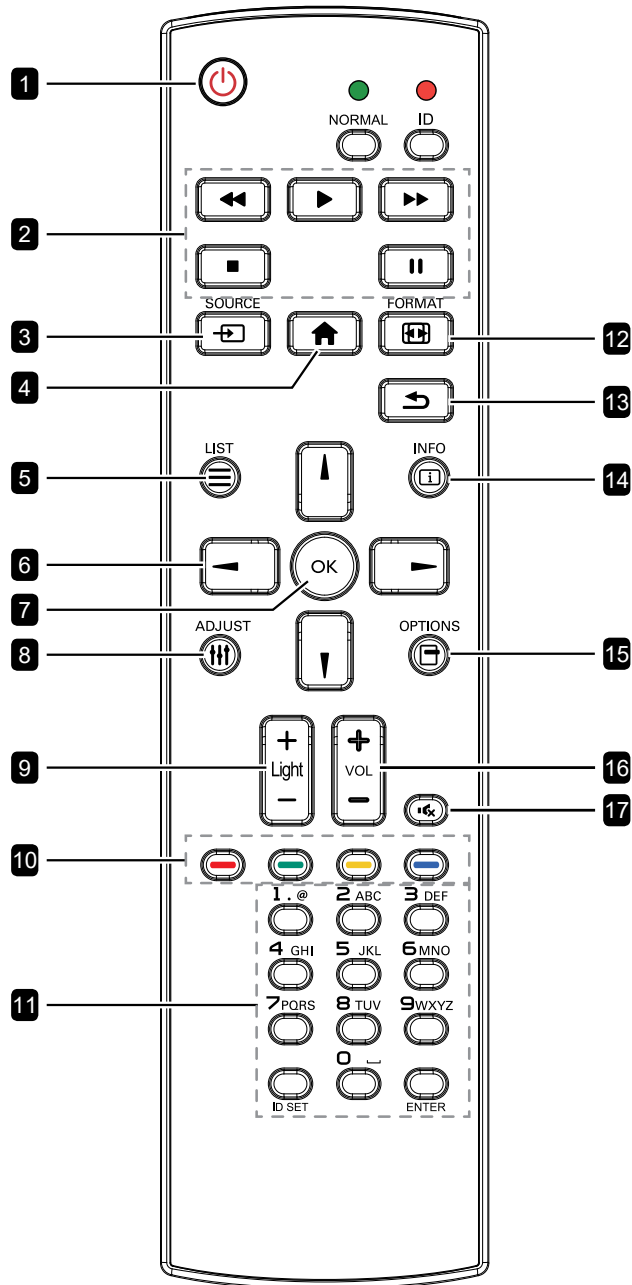

#### 1 [POWER] POWER

Turn the display on or to put the display into standby mode.

#### 2 [PLAY] PLAY

Control playback in multimedia mode.

#### 3 [SOURCE] SOURCE

Select the input source.

#### 4 [HOME] HOME

Access/Exit the OSD menu.

#### 5 [LIST] LIST

No function.

#### 6 [NAVIGATION] NAVIGATION buttons

Navigate through menus and select items.

#### 7 [OK] OK

Confirm an entry or selection.

#### 8 [ADJUST] ADJUST

Automatically optimize the display (for VGA input only).

#### 9 [BRIGHTNESS] BRIGHTNESS

Adjust the brightness.

#### 10 [COLOR] COLOR

No function.

#### 11 [Number/ ID SET/ ENTER]

- Enter text for network setting.
- Set the display ID. See "1.6.2 ID Remote Control" for more detail.

#### 12 [FORMAT] FORMAT

Change the picture size.

#### 13 [BACK] BACK

Return to the previous menu or exit from the previous function.

#### 14 [INFO] INFO

View the information about the display.

#### 15 [OPTIONS] OPTIONS

No function.

#### 16 [VOLUME] VOLUME

Adjust the volume level.

#### 17 [MUTE] MUTE

Turn the mute function on/off.

# PRODUCT DESCRIPTION

## 1.6.2 ID Remote Control

You can set the remote control ID when you want to use this remote control on one of several different displays.

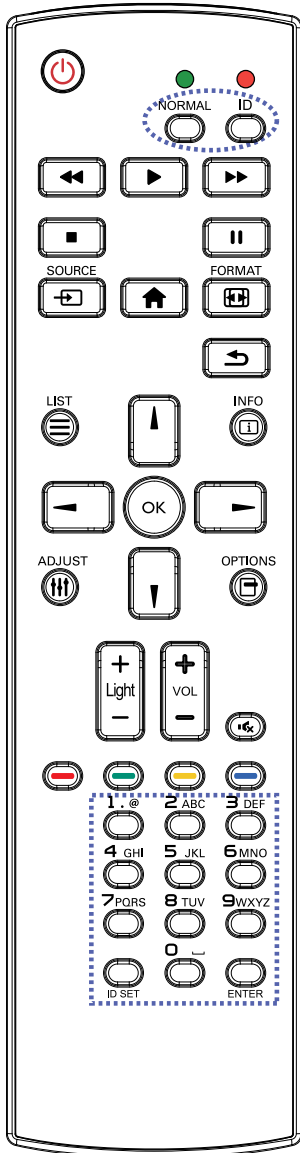

To set the remote control ID:

- 1 Press the **ID** button. The red LED blinks twice.
- 2 Press the **ID SET** button for more than 1 second to enter the ID mode. The red LED lights up. Press the **ID SET** button again will exit the ID mode. The red LED lights off.
- 3 Press the digit numbers [0] ~ [9] to select the display you want to control. For example:
  - Display ID #1: press [0], [1]
  - Display ID #11: press [1], [1]The numbers available are from [01] ~ [255].
  - Not pressing any button within 10 seconds will exit the ID mode.
  - If an error pressing of buttons other than the digits occurred, wait 1 second after the red LED lights off and then lights up again, then press the correct digits again.
- 4 Press the **OK** button to confirm. The red LED blinks twice and then lights off.

### Note:

- ◆ Press the **NORMAL** button. The green LED blinks twice, indicating the remote control returns to normal operation.
- ◆ It is necessary to set up the ID number for each display before selecting its ID number.

# PRODUCT DESCRIPTION

## 1.6.3 Inserting the Batteries in the Remote Control

The remote control is powered by two 1.5V AAA batteries.

To install or replace batteries:

- 1 Press and then slide the cover to open it.
- 2 Align the batteries according to the (+) and (-) indications inside the battery compartment.
- 3 Replace the cover.

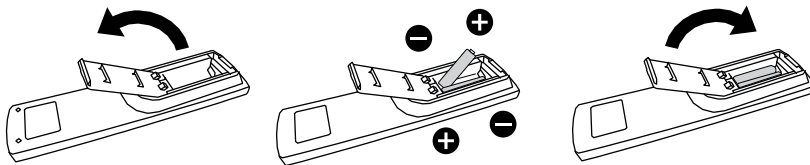

## 1.6.4 Handling the Remote Control

- Do not subject to strong shock.
- Do not allow water or other liquid to splash the remote control. If the remote control gets wet, wipe it dry immediately.
- Avoid exposure to heat and steam.
- Other than to install the batteries, do not open the remote control.

## 1.6.5 Operating Range of the Remote Control

Point the top of the remote control toward the display's remote control sensor (on the left or right side) when pressing a button.

When using the remote control, the distance from the remote control to the sensor on the display should be less than 8m/26ft, and the horizontal and vertical angles should be less than 30°.

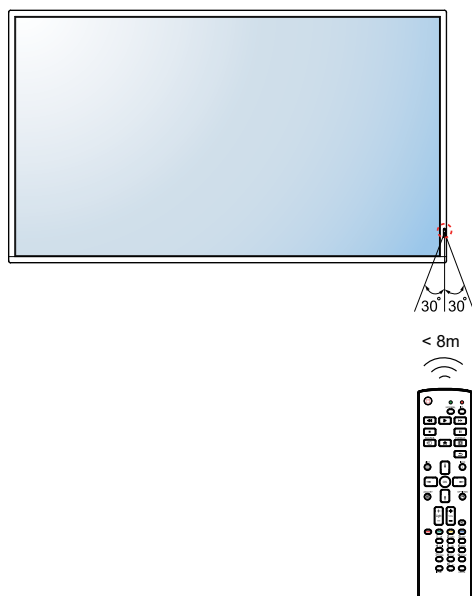

### Caution:

The incorrect use of batteries can result in leaks or bursting. Be sure to follow these instructions:

- ◆ Place "AAA" batteries matching the (+) and (-) signs on each battery to the (+) and (-) signs of the battery compartment.
- ◆ Do not mix battery types.
- ◆ Do not combine new batteries with used ones. It causes shorter life or leakage of batteries.
- ◆ Remove the dead batteries immediately to prevent them from liquid leaking in the battery compartment. Don't touch exposed battery acid, as it can damage your skin.

### Note:

- ◆ If you do not intend to use the remote control for a long period, remove the batteries.
- ◆ The remote control may not function properly when the remote control sensor on this display is under direct sunlight or strong illumination, or when there is an obstacle in the path of signal transmission.



# CHAPTER 2: MAKING CONNECTIONS

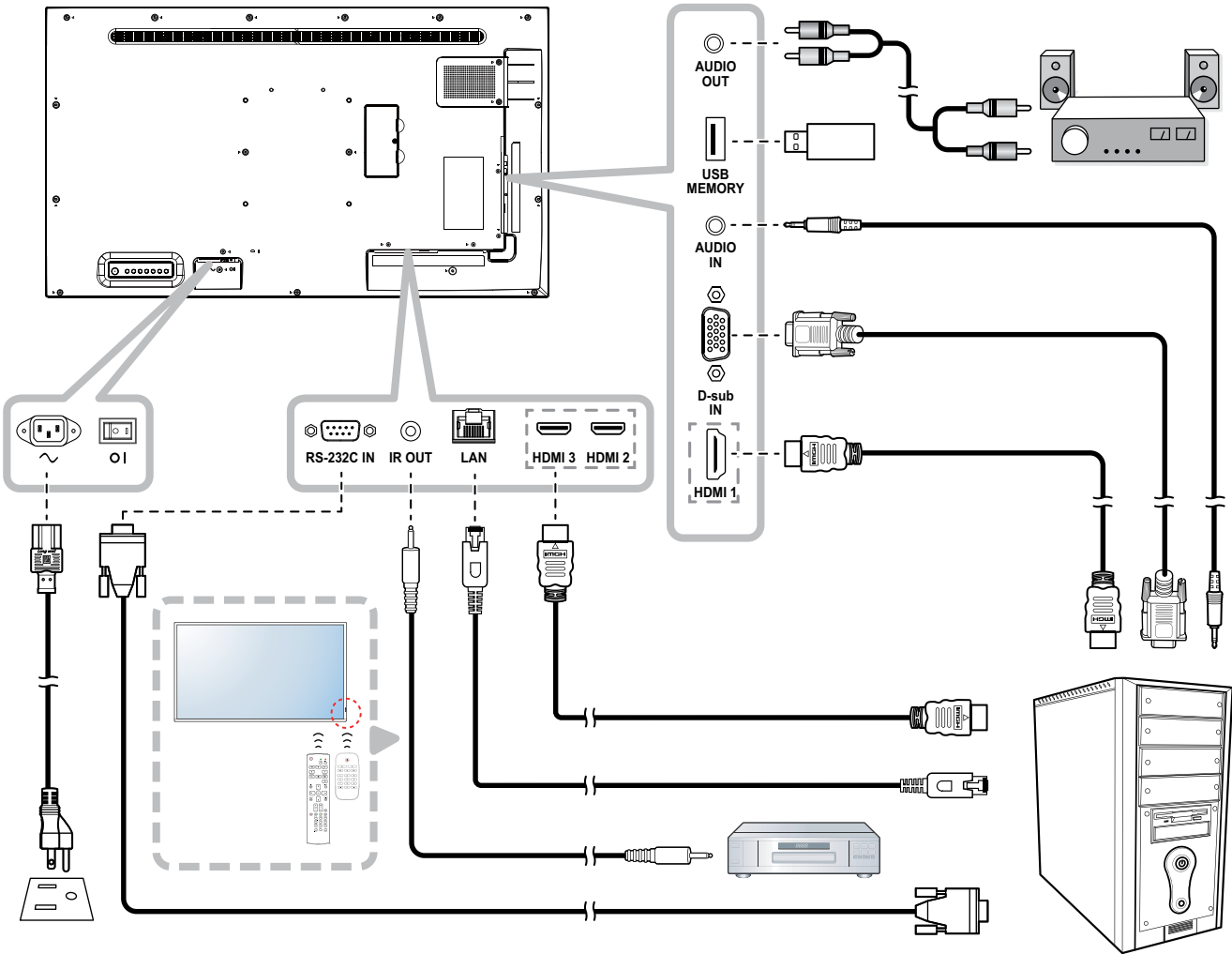

# CHAPTER 3: ON SCREEN DISPLAY MENU

## 3.1 Using the OSD Menu

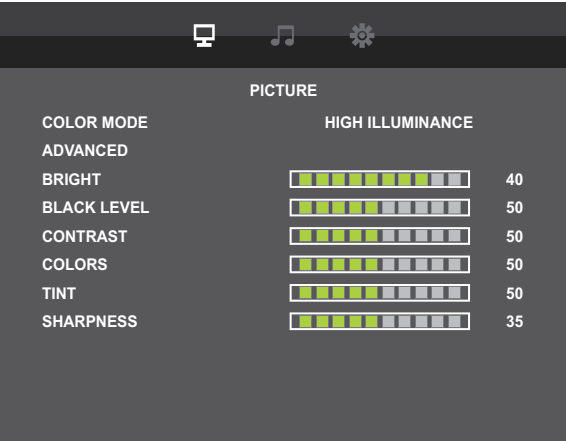
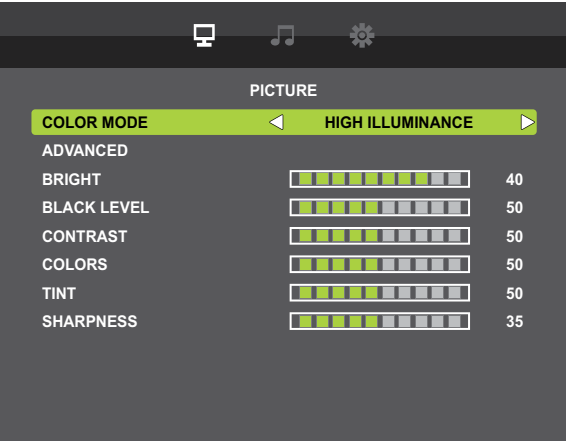
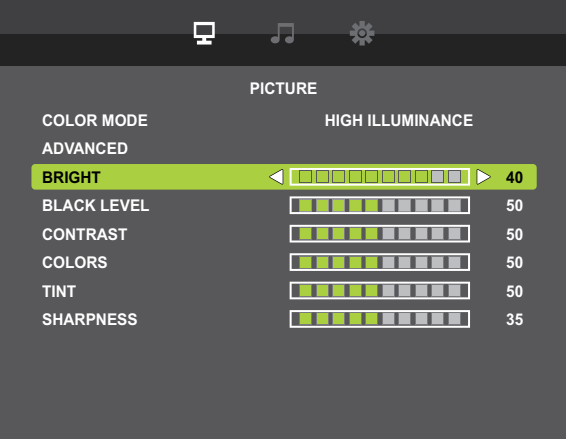
#	Menu Navigation	Operation	
		Control Panel	Remote Control
1	<p>Display the main menu screen.</p> 	<p>1 Press the <b>MENU</b> button.</p> <p>2 Press the <b>+/-</b> button to select the main menu item (□/♪/⚙️).</p>	<p>1 Press the <b>⬆️</b> button.</p> <p>2 Press the <b>⬅️/➡️</b> button to select the main menu item (□/♪/⚙️).</p>
2	<p>Enter the menu screen.</p> 	<p>Press the <b>▼</b> button to enter the menu screen.</p>	<p>Press the <b>OK</b> or <b>⬇️</b> button to enter the menu screen.</p>
3	<p>Select the submenu.</p>  <p>The highlighted item (green) indicates the active submenu.</p>	<p>Press the <b>▲</b> or <b>▼</b> button to select the menu item.</p> <p>If the menu item has the submenu, press the <b>—</b> button to enter its submenu.</p>	<p>Press the <b>⬇️</b> or <b>⬅️</b> button to select the menu item.</p> <p>If the menu item has the submenu, press the <b>OK</b> or <b>➡️</b> button to enter its submenu.</p>

# ON SCREEN DISPLAY MENU

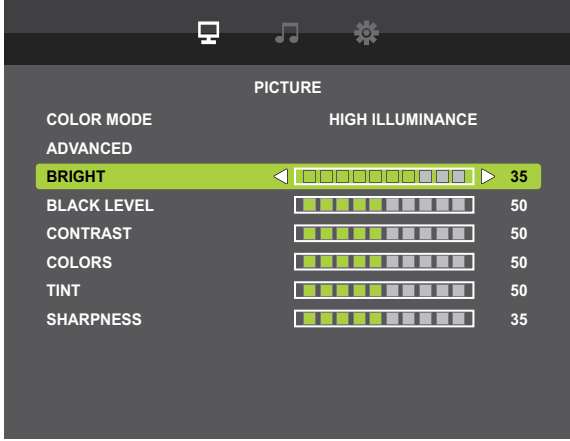
#	Menu Navigation	Operation	
		Control Panel	Remote Control
4	Adjust the settings. For example: 	Press the <b>+</b> or <b>-</b> button to select/adjust the setting.	Press the <b>←</b> or <b>→</b> button to select/adjust the setting.
5	Exit the submenu.	Press the <b>MUTE</b> button to return to the main menu screen.	Press the <b>↶</b> button to return to the previous menu.
6	Close the OSD window.	Press the <b>MENU</b> button.	Press the <b>⬆</b> button or the <b>↶</b> button several times.

When settings are modified, all changes are saved when the user does the following:

- Proceeds to the another menu.
- Exits the OSD menu.
- Waits for the OSD menu to disappear.

## Note:

- ◆ Availability of some menu items depend on the input source signal. If the menu is not available, it is disabled and grayed out.

# ON SCREEN DISPLAY MENU

## 3.2 OSD Menu Tree

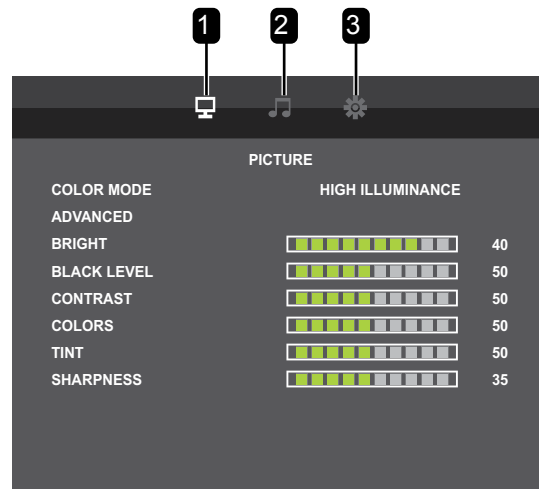

Main Menu	Submenu	Remarks
1. PICTURE	<ul style="list-style-type: none"> <li>• COLOR MODE</li> <li>• ADVANCED</li> <li>• BRIGHT</li> <li>• BLACK LEVEL</li> <li>• CONTRAST</li> <li>• COLORS</li> <li>• TINT</li> <li>• SHARPNESS</li> </ul>	See page 18.
2. AUDIO	<ul style="list-style-type: none"> <li>• TREBLE</li> <li>• BASS</li> <li>• BALANCE</li> <li>• SPEAKER</li> <li>• AUDIO OUTPUT</li> </ul>	See page 20.
3. SETUP	<ul style="list-style-type: none"> <li>• LANGUAGE</li> <li>• DATE/TIME SETTING</li> <li>• SCHEDULE</li> <li>• ALINK</li> <li>• HDMI MODES</li> <li>• COMMUNICATION SETTING</li> <li>• SCREEN</li> <li>• OPERATION MODE</li> <li>• POWER SAVE MODE</li> <li>• OFF IF NO OPERATION</li> <li>• STANDBY</li> <li>• NO SIGNAL AUTO INPUT SEL.</li> <li>• AUTO PLAY</li> <li>• MONITOR BUTTONS LOCK</li> <li>• REMOTE CONTROL LOCK</li> <li>• THERMAL SENSOR SETTING</li> <li>• LED</li> <li>• INFORMATION</li> <li>• ROTATE 180°</li> <li>• ANTI-BURN-IN</li> <li>• ALL RESET</li> </ul>	See page 21.

# CHAPTER 4: ADJUSTING THE LCD DISPLAY

## 4.1 Picture Settings

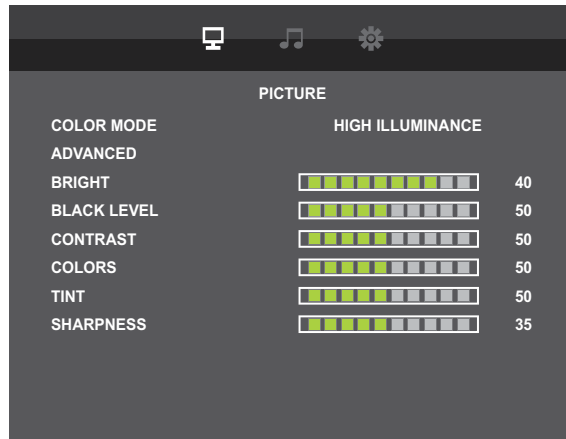

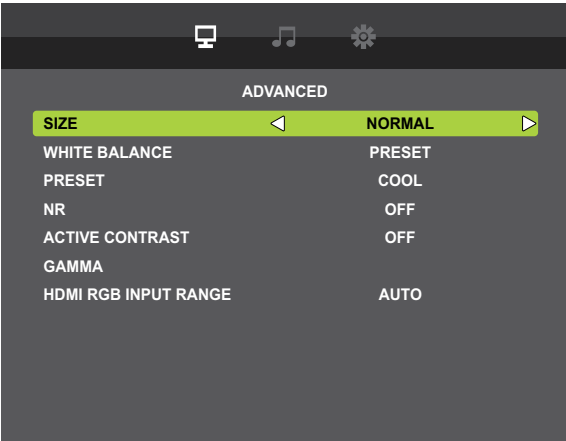
Item	Function	Range
COLOR MODE	Change the color mode on the screen.	STD VIVID sRGB HIGH ILLUMINANCE
ADVANCED		
	SIZE: Switch the screen size.	WIDE ZOOM NORMAL Dot by Dot
	WHITE BALANCE: Select the color temperature. <b>Note:</b> This menu item is not available if the COLOR MODE is set to sRGB.	PRESET USER
	PRESET: Select the color temperature when the WHITE BALANCE is set to PRESET. <b>Note:</b> This menu item is not available if the COLOR MODE is set to sRGB.	WARM NORMAL COOL
	USER: Adjust the bright-toned of the red/green/blue component when the WHITE BALANCE is set to USER. <b>Note:</b> This menu item is not available if the COLOR MODE is set to sRGB. Instead of displaying USER, PRESET is displayed.	R-CONTRAST G-CONTRAST B-CONTRAST

# ADJUSTING THE LCD DISPLAY

Item	Function	Range
ADVANCED ( <i>continue</i> )	NR: Adjust the noise reduction to help remove noise from images. This helps produce clearer and crisper images. <b>Note:</b> Support YCbCr color space for HDMI input.	OFF LOW MIDDLE HIGH
	ACTIVE CONTRAST: Enable/Disable the Active Contrast function. <b>Note:</b> This menu item is not available if the COLOR MODE is set to sRGB and the input source is D-SUB.	OFF ON
	GAMMA: Adjust the non-linear setting for picture luminance and contrast. <b>Note:</b> This menu item is only available if the COLOR MODE is set to STD.	MODE4 MODE3 MODE2 MODE1
	HDMI RGB INPUT RANGE: Set the RGB input signal range. <b>Note:</b> • This menu item is only available support RGB color space for HDMI input.	AUTO FULL LIMITED
BRIGHT	Adjust the luminance of the screen image.	0 to 50
BLACK LEVEL	Adjust the black level of the screen image. Low brightness setting makes black colour darker.	0 to 100
CONTRAST	Adjust the difference between the black level and the white level. <b>Note:</b> This menu item is not available if the input source is D-SUB.	0 to 100
COLORS	Adjust the color saturation of the picture. <b>Note:</b> This menu item is not available if the input source is D-SUB.	0 to 100
TINT	Adjust the colour tint. <b>Note:</b> This menu item is not available if the input source is D-SUB.	0 to 100
SHARPNESS	Adjust the clarity and focus of the screen image. <b>Note:</b> This menu item is not available if the input source is D-SUB.	0 to 63

# ADJUSTING THE LCD DISPLAY

## 4.2 Audio Settings

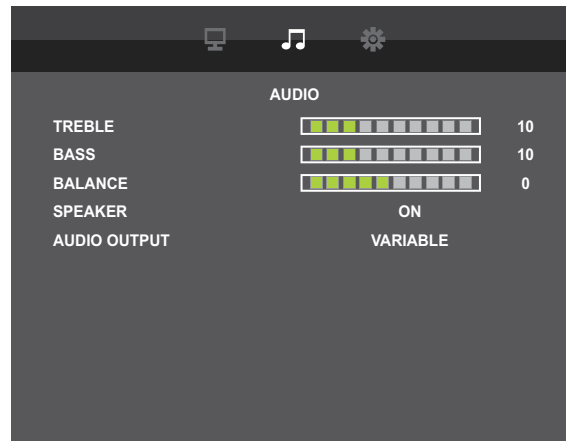

Item	Function	Range
TREBLE	Adjust to increase or decrease the higher-pitched sounds.	0 to 31
BASS	Adjust to increase or decrease the lower-pitched sounds.	0 to 31
BALANCE	Adjust to emphasize the left or right audio output balance.	-50 to 50
SPEAKER	Turn the speaker on/off.	OFF ON
AUDIO OUTPUT	Set the volume of sound output from the audio output terminals. <ul style="list-style-type: none"> <li>VARIABLE: Be able to change the volume with internal speakers and audio output terminals.</li> <li>FIXED: Fix volume of audio output terminal. (If change volume of the display, but it won't reflect to it.)</li> </ul>	VARIABLE FIXED

# ADJUSTING THE LCD DISPLAY

## 4.3 Setup Settings

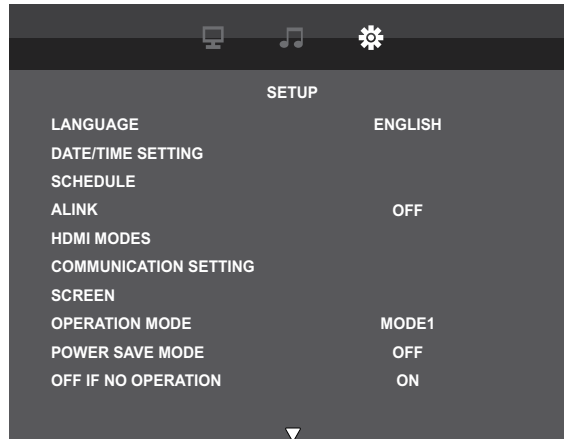

Item	Function	Range
LANGUAGE	Set the OSD language.	ENGLISH DEUTSCH FRANÇAIS ITALIANO ESPAÑOL РУССКИЙ 繁體中文
DATE/TIME SETTING		
	YEAR: Set the year.	2021 to 2099
	MONTH: Set the month.	01 to 12
	DAY: Set the day.	01 to 28, 29, 30, 31
	TIME: Set the time.	<24-HOURS> 00:00 to 23:59 <12-HOURS> 00:00 to 11:59
	AM/PM: Set the time format. <b>Note:</b> This option is not available if the TIME FORMAT is set to 24-HOUR TIME.	AM PM
	TIME FORMAT: Set the time display format.	12-HOUR TIME 24-HOUR TIME

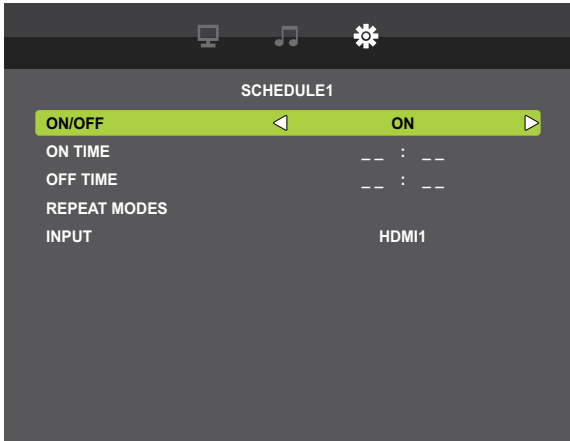

# ADJUSTING THE LCD DISPLAY

Item	Function	Range
<p>SCHEDULE</p>	<p>This function allows you to program up to 7 different scheduled time intervals for this display to activate.</p> <p>You can set:</p> <ul style="list-style-type: none"> <li>• Which input source the display will use for each scheduled activation period.</li> <li>• The time for the display to turn on and turn off.</li> <li>• The days in a week for the display to activate.</li> </ul> <p><b>Note:</b></p> <ul style="list-style-type: none"> <li>• We recommend you to set up current date and time in the DATE/TIME SETTING menu before using this function.</li> <li>• After changing the DATE/TIME SETTING option in the SETUP menu, you need to set this Schedule again.</li> </ul>	
		
	<p>ON/OFF: Enable or disable the schedule.</p>	<p>ON OFF</p>
	<p>ON TIME: Specify the time to turn on the display.</p>	<p>&lt;24-HOURS&gt; 00:00 to 23:59 &lt;12-HOURS&gt; 00:00 AM to 11:59 PM</p>
	<p>OFF TIME: Specify the time to turn off the display.</p>	<p>&lt;24-HOURS&gt; 00:00 to 23:59 &lt;12-HOURS&gt; 00:00 AM to 11:59 PM</p>
	<p>REPEAT MODES: Select the days of the week when the schedule is active.</p>	<p>ONLY ONCE EVERY SUN EVERY MON EVERY TUE EVERY WED EVERY THU EVERY FRI EVERY SAT</p>

# ADJUSTING THE LCD DISPLAY

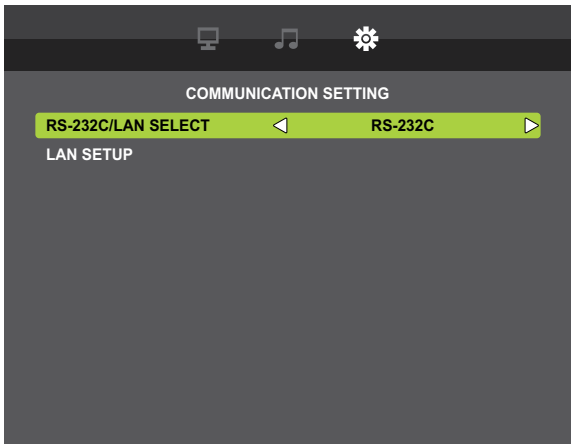
Item	Function	Range
SCHEDULE (continue)	INPUT: Set the input source.	HDMI1 HDMI2 HDMI3 D-SUB USB AUTO PLAY1 AUTO PLAY2
ALINK	Enable or disable HDMI Consumer Electronics Control control. <ul style="list-style-type: none"> <li>• OFF: Disable the function.</li> <li>• AUTO: The system will automatically control the connected HDMI-CEC compatible device on the same power on or power off status.</li> </ul>	OFF AUTO
HDMI MODES	Determine how the content displayed is processed and decoded for the HDMI input source (HDMI1/HDMI2/HDMI3). <ul style="list-style-type: none"> <li>• MODE1: The content will be displayed at the resolution of 3840x2160p @60Hz.</li> <li>• MODE2: The content will be displayed at the resolution of 1920x1080p @60Hz.</li> </ul>	MODE1 MODE2
COMMUNICATION SETTING		
	RS-232C/LAN SELECT: Select the network control port.	RS-232C LAN
	LAN SETUP: Configure the network parameters. <b>Note:</b> This option is not available if the RS-232C/LAN SELECT is set to LAN. <ul style="list-style-type: none"> <li>• VIEW NETWORK SETTINGS: View the current network configurations.</li> <li>• DHCP CLIENT: Select ON to allow the system to assign an IP address automatically. Otherwise, select OFF to manually configure the network settings.</li> <li>• IP ADDRESS: Assign an IP address.</li> <li>• SUBNET MASK: Specify the subnet mask.</li> <li>• DEFAULT GATEWAY: Specify the default gateway.</li> <li>• SET: Save and apply the settings.</li> </ul>	N/A

# ADJUSTING THE LCD DISPLAY

Item	Function	Range
<b>SCREEN</b> <b>Note:</b> This option is available only if the input source is D-SUB.	AUTO: Automatically optimize the display of D-SUB input image.	N/A
	CLOCK: Adjust the width of the image.	0 to 100
	PHASE: Adjust to improve the focus, clarity and stability of the image.	0 to 100
	H-POS: Move the image to the right or left.	0 to 100
	V-POS: Move the image up or down.	0 to 100
	RESET: Resets all settings in the SCREEN menu to the factory preset values.	NO YES
<b>OPERATION MODE</b>	Select the operation mode setting. <ul style="list-style-type: none"> <li>• MODE1:               <ul style="list-style-type: none"> <li>» In case there is no operation for more than 4 hours, the display will automatically go into standby mode.</li> <li>» In case there is no signal for 5 minutes, the display will automatically go into standby mode.</li> <li>» The LAN function is disabled. (During power standby)</li> </ul> </li> <li>• MODE2:               <ul style="list-style-type: none"> <li>» The power consumption can be higher than MODE1.</li> <li>» Networked standby mode can be changed at POWER SAVE MODE setting.</li> </ul> </li> </ul> <b>Note:</b> The POWER SAVE MODE/OFF IF NO OPERATION/STANDBY menu option is not available if the setting is set to MODE1.	MODE1 MODE2
<b>POWER SAVE MODE</b>	Enable or disable the power saving mode. When OFF is selected, startup time from standby mode is reduced. Note, however, that more power will be consumed in standby mode. When ON is selected, current consumption is reduced while the monitor is in standby mode. Note, however, that the startup time from standby mode becomes longer. If set to ON, certain RS-232C commands and LAN control cannot be used in standby mode. <b>Note:</b> This menu item is not available if the OPERATION MODE is set to MODE1.	OFF ON
<b>OFF IF NO OPERATION</b>	Set whether or not the display automatically enters standby mode when there is no operation for 4 hours. <b>Note:</b> This menu item is not available if the OPERATION MODE is set to MODE1.	OFF ON
<b>STANDBY</b>	Set whether or not the display automatically enters standby mode when there is no signal detected. <b>Note:</b> This menu item is not available if the OPERATION MODE is set to MODE1.	OFF ON
<b>NO SIGNAL AUTO INPUT SEL.</b>	Enable or disable the device to detect and display from available video input automatically. <b>Note:</b> This menu item is not available if the OPERATION MODE is set to MODE1.	OFF ON
<b>AUTO PLAY</b>	Disable the function or set the type of file to be automatically played from a USB flash drive.	OFF PHOTO MOVIE

# ADJUSTING THE LCD DISPLAY

Item	Function	Range
MONITOR BUTTONS LOCK	Enable or disable the control panel buttons function of the LCD display. <b>Note:</b> <ul style="list-style-type: none"> <li>To unlock the function by using the remote control, press "OPTIONS", "UP", "DOWN", "LEFT", and "RIGHT" buttons.</li> </ul>	UNLOCKED LOCK ALL
REMOTE CONTROL LOCK	Enable or disable some or all remote control buttons. <ul style="list-style-type: none"> <li>UNLOCKED: Unlock all remote control buttons.</li> <li>LOCK ALL: Lock all remote control buttons.</li> <li>LOCK EXCEPT VOLUME: Lock all remote control buttons except for the <b>Volume</b> control buttons.</li> <li>LOCK EXCEPT POWER: Lock all remote control buttons except for the Power button.</li> </ul> <b>Note:</b> <ul style="list-style-type: none"> <li>To unlock the function by using the remote control, press "OPTIONS", "UP", "DOWN", "LEFT", and "RIGHT" buttons.</li> </ul>	UNLOCKED LOCK ALL LOCK EXCEPT VOLUME LOCK EXCEPT POWER
THERMAL SENSOR SETTING	Set it correctly according to the installation direction of the monitor.	LANDSCAPE PORTRAIT FACE UP
LED	Set the display LED indicator on or off.	OFF ON
INFORMATION	View the information about your LCD display.	N/A
ROTATE 180°	Set whether or not the video/OSD menu can be rotated to 180 degrees.	OFF ON
ANTI-BURN-IN	Enable or disable Anti-Burn-in™ function. For the monitor to slightly shift the position of pixel in two directions (left, right).	OFF ON
ALL RESET	Resets all settings to the factory preset values.	NO YES

# CHAPTER 5: MULTIMEDIA

## 5.1 Overview

- Play photo files, audio files and movie files equipped in USB flash.
- There are 2 play modes as ManualPlay and AutoPlay.
  - With ManualPlay, it implements BGM function that select audio file playing photo files.
  - Not support to play audio files with AutoPlay mode.

## 5.2 Supported Format

- The following file type are supported.

Media Type	Supported Extensions
Photo	jpg, jpeg
Audio	mp3
Movie	mp4, ts (mpg *1)

\*1: Other than MP4 and TS are not described in user manual, so they are officially unsupported.

- Available specs to play with each media type are as follows.

### USB Multimedia Codec Formats

Type	Format	Video Codec	Audio Codec
Movie	.mp4	H.264	MPEG-1 Layer2, MPEG-1 Layer3, MPEG-2 Layer3,
	.ts	MPEG2, H.264	AC3, LPCM, ADPCM, AAC, DD+,HE- AAC
	.mpg	MPEG-1, MPEG-2	
Audio	.mp3		MPEG-1 Layer2, MPEG-1 Layer3, MPEG-2 Layer3
Photo	.jpg/.jpeg		

### Note:

#### When the monitor is reading data from a USB device, please observe the following:

- ◆ The above file formats may not play properly. Some resolution or other factors may make the file unplayable.
- ◆ Some USB storage devices may not be compatible.
- ◆ It might not be possible to play some files due to their data type or file size.
- ◆ The manufacturer is not responsible if the USB device is not supported, nor is it responsible for damage to or loss of data in the device.

# MULTIMEDIA

## 5.3 Supported USB Flash

File system	FAT16/32, NTFS
Max capacity	32GB(FAT32), 2TB(NTFS)
Mac file size	4GB(FAT32)
USB Encrypted flash drive	Not Supported

※ Not support memory device with multi partition.

## 5.4 Play Mode

There are Manual play mode and Auto play mode as a way to play files.

Mode	How to Start	Supported File			Content
		Photo	Audio	Movie	
Manual Play	Select files or a folder and play them.	○	○	○	<ul style="list-style-type: none"> <li>Play selected files or all of supported files in current folder.</li> <li>Play selected audio file as background music while playing photo.</li> </ul>
Auto Play	Start to play automatically if meet conditions when turn on the main power or the monitor.				<ul style="list-style-type: none"> <li>Automatically play defined name files in "autoplay" folder.</li> <li>Add values of "USB1" and "USB2" for input selection for schedule setting.</li> <li>If schedule function invoke autoplay with "USB1", automatical play defined name files in "autoplay1" folder.</li> <li>If schedule function invoke autoplay with "USB2", automatical play defined name files in "autoplay2" folder.</li> </ul>
	Start to play automatically if meet conditions instert a memory device.	○	X	○	
	Start to play automatically if set input mode to schedule when it is executed.				

## 5.5 Order to Play Files

The order to play by auto play.

Play defined named files from "001" to "030".

# MULTIMEDIA

## 5.6 Detail of Each Screen

### Select Media type screen

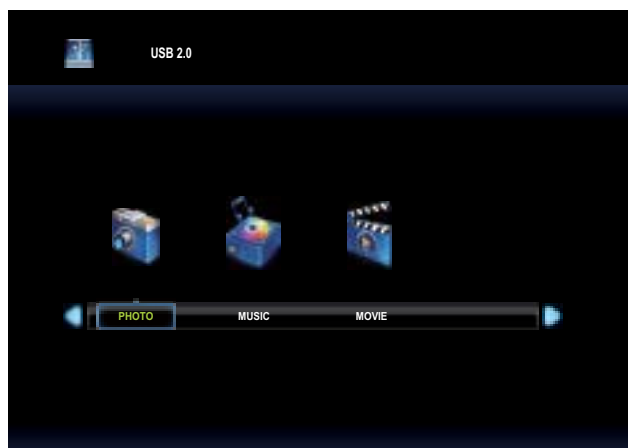

- Select media type to play.

Item	Function
PHOTO	Enter photo file browser
MUSIC	Enter audio file browser
MOVIE	Enter movie file browser

- Function Icons are different with media type.

Function	Option	Photo	Audio	Movie	Note
Play	-	<input type="radio"/>	<input type="radio"/>	<input type="radio"/>	
Pause	-	<input type="radio"/>	<input type="radio"/>	<input type="radio"/>	
FB	FB2X, FB4X, FB8X, FB16X, FB32X	X	<input type="radio"/>	<input type="radio"/>	FB32X is for only MOVIE.
FF	FF2X, FF4X, FF8X, FF16X, FF32X	X	<input type="radio"/>	<input type="radio"/>	FB32X is for only MOVIE.
Prev.	-	<input type="radio"/>	<input type="radio"/>	<input type="radio"/>	
Next	-	<input type="radio"/>	<input type="radio"/>	<input type="radio"/>	
Stop	-	<input type="radio"/>	<input type="radio"/>	<input type="radio"/>	
Repeat	None, 1File, All	<input type="radio"/>	<input type="radio"/>	<input type="radio"/>	Invalid and fixed to "All" with Auto Play.
Repeat during A-B	-	X	<input type="radio"/>	<input type="radio"/>	Invalid with Auto Play.
Random Repeat	On, Off	<input type="radio"/>	<input type="radio"/>	<input type="radio"/>	Invalid with Auto Play.
Music On/Off	On, Off	<input type="radio"/>	X	X	
Slideshow time	Short 5sec, Medium 10sec, Long 15sec	<input type="radio"/>	X	X	
Playlist	-	<input type="radio"/>	<input type="radio"/>	<input type="radio"/>	
Info.	-	<input type="radio"/>	<input type="radio"/>	<input type="radio"/>	
Rotate 90 degrees Clockwise	-	<input type="radio"/>	X	X	
Rotate 90 degrees Anti-Clockwise	-	<input type="radio"/>	X	X	
Zoom In	Fill, X1, X2, X4	<input type="radio"/>	X	X	
Zoom Out	Fill, X1, X2, X4	<input type="radio"/>	X	X	
Move View	-	<input type="radio"/>	X	X	
Wide	-, Photo	X	X	X	

# MULTIMEDIA

## 5.7 AutoPlay

- There are 3 type AutoPlay by turning on the monitor, inserting a media and schedule.
  1. AutoPlay by turning on the monitor
 

Start to play automatically with matching the condition of AutoPlay as turning on the monitor

※ However, execute schedule setting prior to this AutoPlay when turning on by schedule.

If SCHEDULE-INPUT is “AUTO PLAY1” or “AUTO PLAY2” and turning on by schedule, execute schedule setting same as above explain.
  2. AutoPlay by inserting a media
 

Start to play automatically with matching the condition of AutoPlay as inserting a media.
  3. AutoPlay by schedule
 

Start to play automatically with matching the condition of AutoPlay as executing a schedule.
- Limitation and condition of AutoPlay

Condition	By turning on the monitor	By inserting a media	By schedule
Location of target files	/root/autoplay	/root/autoplay	/root/autoplay, /root/autoplay1, /root/autoplay2
Playlist	Not need to make the file.	Not need to make the file.	Not need to make the file.
Supported file	jpg or mp4	jpg or mp4	jpg or mp4
A number of target files	Max 30 files	Max 30 files	Max 30 files
Combination with Photo and Movie	Impossible	Impossible	Impossible
Rule of target file name	ex.) "001.jpg", "002.jpg", "003.jpg"... "030.jpg"	ex.) "001.jpg", "002.jpg", "003.jpg"... "030.jpg"	ex.) "001.jpg", "002.jpg", "003.jpg"... "030.jpg"
Setting of AutoPlay	OFF/PHOTO/MOVIE	OFF/PHOTO/MOVIE	OFF/PHOTO/MOVIE

## 5.8 Setting of Schedule Enabling AutoPlay

With below condition, Auto Play by schedule is started.

- 1) Set the input mode of the schedule to “USB” or “AUTO PLAY1” or “AUTO PLAY2”.
- 2) The power on time of the schedule comes.
- 3) A USB flash is inserted.
- 4) Target files to play exists in the specified folder of the USB flash.

Refer to following folder by setting SCHEDULE-INPUT.

SCHEDULE->INPUT	USB	AUTO PLAY1	AUTO PLAY2
Referenced folder	USB root/autoplay	USB root/autoplay1	USB root/autoplay2

If the AUTO PLAY setting is “PHOTO”, the photo contents are played.

If the AUTO PLAY setting is “MOVIE”, the movie contents are played.

- ※ Do not play automatically if turn on the monitor by the schedule that doesn't match the condition.
- When AUTO PLAY in OSD is “OFF” and SCHEDULE-INPUT is “USB” or “AUTO PLAY1” or “AUTO PLAY2”, change input mode to USB(Media player mode) but NO contents are played.



# CHAPTER 6: APPENDIX

## 6.1 Warning Messages

Warning Messages	Cause	Solution
INPUT SIGNAL OUT OF RANGE	The resolution or the refresh rate of the graphics card of the computer is set too high.	<ul style="list-style-type: none"><li>• Change the resolution or the refresh rate of the graphics card.</li></ul>
Multi-color screen	The LCD display cannot detect the input source signal.	<ul style="list-style-type: none"><li>• Check if the input source is turned ON.</li><li>• Check if the signal cable is properly connected.</li><li>• Check if any pin inside the cable connector is twisted or broken.</li></ul>
MONITOR BUTTONS LOCK	The operation using the control panel buttons has been locked by the user.	<ul style="list-style-type: none"><li>• Disable the keyboard lock function in <b>SETUP &gt; MONITOR BUTTONS LOCK</b> menu. See page 25.</li></ul>
REMOTE CONTROL LOCK	The operation using the remote control buttons has been locked by the user.	<ul style="list-style-type: none"><li>• Disable the remote control lock function in <b>SETUP &gt; REMOTE CONTROL LOCK</b> menu. See page 25.</li></ul>

# APPENDIX

## 6.2 Input Mode

### PC Signal

Resolution	Horizontal	Vertical	Dot	VGA	HDMI	
	Frequency (kHz)	Frequency (Hz)	Frequency (MHz)			
VESA	640×480	31.5	60	25.175	✓	✓
	800×600	37.9	60	40	✓	✓
	848×480	31	60	33.75	✓	X
	1024×768	48.4	60	65	✓	✓
	1289×800	49.7	60	83.5	✓	✓
	1280×960	60	60	108	✓	✓
	1280×1024	64	60	108	✓	✓
		80	75	135	✓	✓
	1360×768	47.7	60	85.5	X	✓
	1440×1050	65.3	60	121.75	X	✓
	1440×900	55.9	60	106.5	✓	✓
1680×1050	65.3	60	146.25	✓	✓	
Wide	1280×720	44.7	60	74.4	✓	✓
	1920×1080	67.5	60	148.5	✓	✓
	3840×2160	54	24	297	X	✓
		56.25	25	297	X	✓
		67.5	30	297	X	✓
		112.5	50	594	X	✓
135	60	594	X	✓		
US TEXT	720×400	31.5	70	28.3	✓	✓

# APPENDIX

## AV Signal

Standard Resolution	Frequency	HDMI
3840 × 2160p	24Hz	Yes
	25Hz	Yes
	30Hz	Yes
	50Hz	Yes
	59.94Hz	Yes
	60Hz	Yes
1920 × 1080p	24Hz	Yes
	50Hz	Yes
	59.94Hz	Yes
	60Hz	Yes
1920 × 1080i	50Hz	Yes
	59.94Hz	Yes
	60Hz	Yes
720 × 576p	50Hz	Yes
720 × 480p	59.94Hz	Yes
	60Hz	Yes
640 × 480p(VGA)	59.94Hz	Yes
	60Hz	Yes
720(1440) × 576i	50Hz	Yes
720(1440) × 480i	59.94Hz	Yes
	60Hz	Yes

### General guidelines:

- The PC text quality is optimum in HD 1080 mode (1920 x 1080, 60Hz).
- Your PC display screen might appear different depending on the manufacturer (and your particular version of Windows).
- Check your PC instruction book for information about connecting your PC to a display.
- If a vertical and horizontal frequency-select mode exists, select 60Hz (vertical) and 31.5KHz (horizontal). In some cases, abnormal signals (such as stripes) might appear on the screen when the PC power is turned off (or if the PC is disconnected). If so, press the **SOURCE** button to enter the video mode. Also, make sure that the PC is connected.
- When horizontal synchronous signals seem irregular in RGB mode, check PC standby mode or cable connections.
- The display settings table complies to the IBM/VESA standards, and based on the analog input.
- The best timing for the vertical frequency to each mode is 60Hz.

## 6.3 Cleaning

### Caution When Using the Display

- Do not bring your hands, face or objects close to the ventilation holes of the display. The top of the display is usually very hot due to the high temperature of exhaust air being released through the ventilation holes. Burns or personal injuries may occur if any body parts are brought too close. Placing any object near the top of the display could also result in heat related damage to the object as well as the display itself.
- Be sure to disconnect all cables before moving the display. Moving the display with its cables attached may damage the cables and thus cause fire or electric shock.
- Disconnect the power plug from the wall outlet as a safety precaution before carrying out any type of cleaning or maintenance procedure.

### Front Panel Cleaning Instructions



- The front of the display has been specially treated. Wipe the surface gently using only a cleaning cloth or a soft, lint-free cloth.
- If the surface becomes dirty, soak a soft, lint-free cloth in a mild detergent solution. Wring the cloth to remove excess liquid. Wipe the surface of the display to remove dirt. Then use a dry cloth of the same type to dry.
- Do not scratch or hit the surface of the panel with fingers or hard objects of any kind.
- Do not use volatile substances such as insert sprays, solvents and thinners.

### Cabinet Cleaning Instructions

- If the cabinet becomes dirty, wipe the cabinet with a soft, dry cloth.
- If the cabinet is extremely dirty, soak a lint-free cloth in a mild detergent solution. Wring the cloth to remove as much moisture as possible. Wipe the cabinet. Use another dry cloth to wipe over until the surface is dry.
- Do not allow any water or detergent to come into contact with the surface of the display. If water or moisture gets inside the unit, operating problems, electrical and shock hazards may result.
- Do not scratch or hit the cabinet with fingers or hard objects of any kind.
- Do not use volatile substances such as insert sprays, solvents and thinners on the cabinet.
- Do not place anything made from rubber or PVC near the cabinet for any extended periods of time.

# APPENDIX

## 6.4 Troubleshooting

Symptom	Possible Cause	Remedy
No picture is displayed	<ul style="list-style-type: none"> <li>The power cord has been disconnected.</li> <li>The main power switch on the back of the display is not switched on.</li> <li>The selected input has no connection.</li> <li>The display is in standby mode.</li> </ul>	<ol style="list-style-type: none"> <li>1 Plug in the power cord.</li> <li>2 Make sure the power switch is switched on.</li> <li>3 Connect a signal connection to the display.</li> </ol>
Interference displayed on the display or audible noise is heard	Caused by surrounding electrical appliances or fluorescent lights.	Move the display to another location to see if the interference is reduced.
Colour is abnormal	The signal cable is not connected properly.	Make sure that the signal cable is attached firmly to the back of the display.
Picture is distorted with abnormal patterns	<ul style="list-style-type: none"> <li>The signal cable is not connected properly.</li> <li>The input signal is beyond the capabilities of the display.</li> </ul>	<ul style="list-style-type: none"> <li>Make sure that the signal cable is attached firmly.</li> <li>Check the video signal source to see if it is beyond the range of the display. Please verify its specifications with this display's specification section.</li> </ul>
Display image doesn't fill up the full size of the screen	The picture size is not set correctly.	Press the  <b>FORMAT</b> button and select a suitable picture size.
Can hear sound, but no picture	Improperly connected source signal cable.	Make sure that both video inputs and sound inputs are correctly connected.
Can see picture but no sound is heard	<ul style="list-style-type: none"> <li>Improperly connected source signal cable.</li> <li>Volume is turned all the way down.</li> <li><b>MUTE</b> function is turned on.</li> <li>No external speaker connected.</li> </ul>	<ul style="list-style-type: none"> <li>Make sure that both video and sound inputs are correctly connected.</li> <li>Press the <b>+</b> or <b>-</b> button to hear the sound.</li> <li>Switch the <b>MUTE</b> function off by using the  button.</li> <li>Connect the external speakers and adjust the volume to a suitable level.</li> </ul>
Some picture elements do not light up	Some pixels of the display may not turn on.	This display is manufactured using an extremely high level of precision technology: however, sometimes some pixels of the display may not display. This is not a malfunction.
After-Images can still be seen on the display after the display is powered off. (Examples of still pictures include logos, video games, computer images, and images displayed in 4:3 normal mode)	A still picture is displayed for an over extended period of time.	Ensure that the ANTI-BURN-IN function has been enabled to prevent burn-in. Please refer to page 5.

# CHAPTER 7: SPECIFICATIONS

## 7.1 Display Specifications

		QM-4302	QM-5502	QM-6502
Panel	Panel Type	LED-Backlit TFT LCD (IPS Technology)	LED-Backlit TFT LCD (IPS Technology)	LED-Backlit TFT LCD (IPS Technology)
	Panel Size	42.5"	54.6"	64.5"
	Max. Resolution	UHD 3840 x 2160	UHD 3840 x 2160	UHD 3840 x 2160
	Pixel Pitch	0.245 mm	0.315 mm	0.372 mm
	Brightness	400 cd/m <sup>2</sup>	400 cd/m <sup>2</sup>	400 cd/m <sup>2</sup>
	Contrast Ratio	4500:1 (DCR)	5000:1 (DCR)	4000:1 (DCR)
	Viewing Angle (H/V)	178°/178°	178°/178°	178°/178°
	Display Colour	1.07B	1.07B	1.07B
	Response Time	5 ms	5 ms	5 ms
	Surface Treatment	Anti-Glare Treatment (Haze 1%), 3H Hard Coating	Anti-Glare Treatment (Haze 3%), 2H Hard Coating	Anti-Glare Treatment (Haze 1%), 3H Hard Coating
Signal Input	VGA	15-Pin D-Sub	15-Pin D-Sub	15-Pin D-Sub
	HDMI	2.0 x 3	2.0 x 3	2.0 x 3
External Control	IR Out	3.5 mm Phone Jack	3.5 mm Phone Jack	3.5 mm Phone Jack
	RS232 In	9-Pin D-Sub	9-Pin D-Sub	9-Pin D-Sub
	LAN	RJ45 x 1	RJ45 x 1	RJ45 x 1
Other connectivity	USB	2.0 x 1 (Service Port / Media Playback)	2.0 x 1 (Service Port / Media Playback)	2.0 x 1 (Service Port / Media Playback)
Audio	Audio In	Stereo Audio Jack (3.5 mm)	Stereo Audio Jack (3.5 mm)	Stereo Audio Jack (3.5 mm)
	Audio Out	Stereo Audio Jack (RCA)	Stereo Audio Jack (RCA)	Stereo Audio Jack (RCA)
	Internal speaker	10W x 2	10W x 2	10W x 2
Power	Power Supply	Internal	Internal	Internal
	Power Requirements	AC 100-240V, 50/60 Hz	AC 100-240V, 50/60 Hz	AC 100-240V, 50/60 Hz
	On Mode	102W (On)	135W (On)	167W (On)
	Standby Mode	< 0.5W	< 0.5W	< 0.5W
	Off Mode	< 0.3W	< 0.3W	< 0.3W
Operating Conditions	Temperature	0°C-40°C (32°F-104°F)	0°C-40°C (32°F-104°F)	0°C-40°C (32°F-104°F)
	Humidity	20%-80% (non-condensing)	20%-80% (non-condensing)	20%-80% (non-condensing)
Storage Conditions	Temperature	-20°C-60°C (-4°F-140°F)	-20°C-60°C (-4°F-140°F)	-20°C-60°C (-4°F-140°F)
	Humidity	10%-90% (non-condensing)	10%-90% (non-condensing)	10%-90% (non-condensing)
Mounting	VESA FPM PMI	Yes (200 x 200 mm)	Yes (400 x 400 mm)	Yes (400 x 400 mm)
Dimensions	w/o base (W x H x D)	973.0 x 561.2 x 63.5 mm (38.3" x 22.1" x 2.5")	1241.8 x 712.6 x 63.6 mm (48.9" x 28.1" x 2.5")	1462.3 x 837.3 x 81.0 mm (57.6" x 33.0" x 3.2")
	Packaging (W x H x D)	1070.0 x 673.0 x 141.0 mm (42.1" x 26.5" x 5.5")	1350.0 x 860.0 x 160.0 mm (53.1" x 33.8" x 6.3")	1580.0 x 1050.0 x 151.0 mm (62.2" x 41.3" x 5.9")
Weight	w/o base	10.8 kg (23.8 lb)	17.2 kg (37.9 lb)	28.5 kg (62.8 lb)
	Packaging	13.6 kg (30.0 lb)	21.4 kg (47.2 lb)	33.8 kg (74.5 lb)

# SPECIFICATIONS

## 7.2 Display Dimensions

### QM-4302

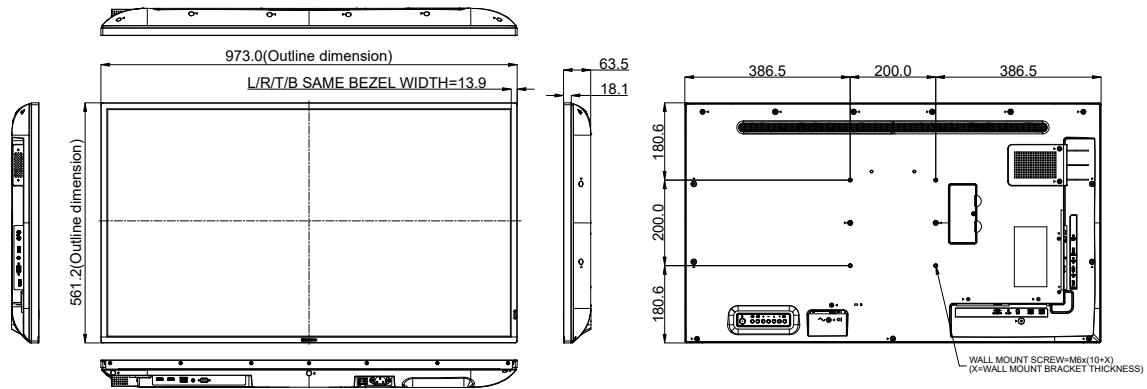

### QM-5502

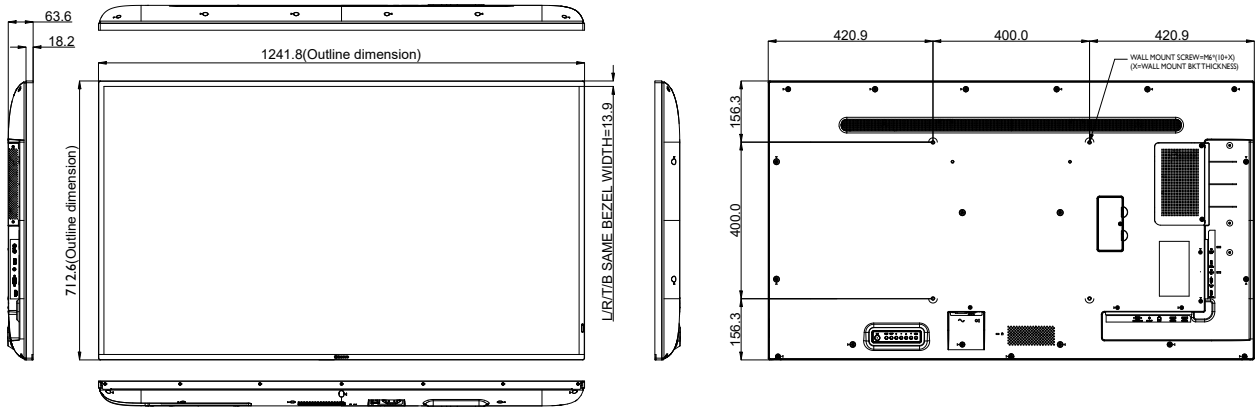

### QM-6502

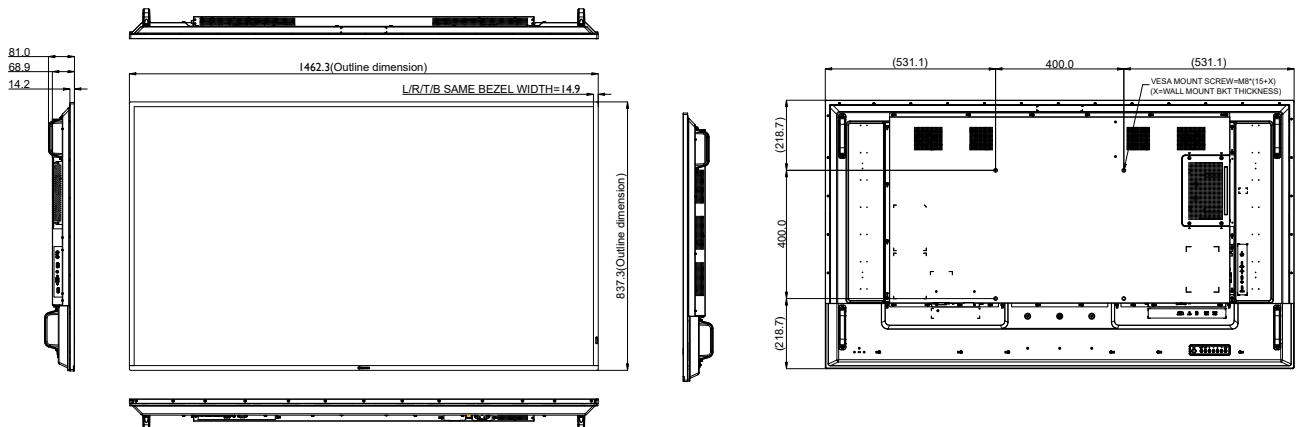

### AG Neovo

Company Address: 5F-1, No. 3-1, Park Street, Nangang District, Taipei, 11503, Taiwan.

Copyright © 2022 AG Neovo. All rights reserved.

QM-4302/5502/6502 Eprel Registration Number: 1090616/1090617/1090620

QM4320/QM5520/QM6520\_UM\_V010