



THE DISPLAY CHOICE
OF PROFESSIONALS™

HMQ-4301, HMQ-5501 & HMQ-6501 LED-Backlit Display

www.agneovo.com

User Manual

TABLE OF CONTENTS

SAFETY INFORMATION	1
Federal Communications Commission (FCC) Notice (U.S. Only).....	1
CE Declaration of Conformity	1
Polish Center for Testing and Certification Notice	1
Electric, Magnetic and Electromagnetic Fields (“EMF”)	2
Information for U.K. only.....	3
North Europe (Nordic Countries) Information.....	4
End-of-Life Disposal	5
Waste Electrical and Electronic Equipment-WEEE.....	5
Turkey RoHS	6
Ukraine RoHS	6
PRECAUTIONS	7
Cautions When Setting Up	7
Cautions When Using.....	8
Cleaning and Maintenance.....	8
Notice for the LCD Display	9
CHAPTER 1: PRODUCT DESCRIPTION.....	10
1.1 Unpacking	10
1.2 Package Contents	10
1.3 Preparing for the Installation	11
1.4 Wall Mounting Installation.....	11
1.4.1 VESA Grid	12
1.4.2 Ventilation Requirements for Enclosure Locating	12
1.5 LCD Display Overview	13
1.5.1 Control Panel.....	13
1.5.2 Input/Output Terminals	14
1.6 Remote Control	16
1.6.1 General Functions	16
1.6.2 Inserting the Batteries in the Remote Control	17
1.6.3 Handling the Remote Control	17
1.6.4 Operating Range of the Remote Control.....	18
CHAPTER 2: MAKING CONNECTIONS.....	19
CHAPTER 3: ON SCREEN DISPLAY MENU.....	20
3.1 Using the OSD Menu	20
3.2 OSD Menu Tree	22
CHAPTER 4: ADJUSTING THE LCD DISPLAY	23
4.1 Picture	23
4.2 Sound	26
4.3 Setting	28
4.4 Network	32

TABLE OF CONTENTS

CHAPTER 5: APPENDIX.....	33
5.1 Warning Messages.....	33
5.2 Supported Resolutions	34
5.3 Cleaning	37
5.4 Troubleshooting.....	38
CHAPTER 6: SPECIFICATIONS	39
6.1 Display Specifications	39
6.2 Display Dimensions.....	40

SAFETY INFORMATION

Federal Communications Commission (FCC) Notice (U.S. Only)



This equipment has been tested and found to comply with the limits for a Class A digital device, pursuant to part 15 of the FCC Rules. These limits are designed to provide reasonable protection against harmful interference when the equipment is operated in a commercial environment. This equipment generates, uses, and can radiate radio frequency energy and, if not installed and used in accordance with the instruction manual, may cause harmful interference to radio communications. Operation of this equipment in a residential area is likely to cause harmful interference in which case the user will be required to correct the interference at his own expense.



Changes or modifications not expressly approved by the party responsible for compliance could void the user's authority to operate the equipment.

Use only an RF shielded cable that was supplied with the display when connecting this display to a computer device.

To prevent damage which may result in fire or shock hazard, do not expose this appliance to rain or excessive moisture.

THIS CLASS A DIGITAL APPARATUS MEETS ALL REQUIREMENTS OF THE CANADIAN INTERFERENCE CAUSING EQUIPMENT REGULATIONS.



This device complies with part 15 of the FCC Rules. Operation is subject to the following two conditions: (1) This device may not cause harmful interference, and (2) this device must accept any interference received, including interference that may cause undesired operation.

CE Declaration of Conformity

This device complies with the requirements set out in the Council Directive on the Approximation of the Laws of the Member States relating to Electromagnetic Compatibility (2014/30/EU), Low-voltage Directive (2014/35/EU), RoHS directive (2011/65/EU).

This product has been tested and found to comply with the harmonized standards for Information Technology Equipment, these harmonized standards published under Directives of Official Journal of the European Union.

Polish Center for Testing and Certification Notice

The equipment should draw power from a socket with an attached protection circuit (a three-prong socket). All equipment that works together (computer, display, printer, and so on) should have the same power supply source.

The phasing conductor of the room's electrical installation should have a reserve short-circuit protection device in the form of a fuse with a nominal value no larger than 16 amperes (A).

To completely switch off the equipment, the power supply cable must be removed from the power supply socket, which should be located near the equipment and easily accessible.

A protection mark "B" confirms that the equipment is in compliance with the protection usage requirements of standards PN-93/T-42107 and PN-89/E-06251.

SAFETY INFORMATION

Wymagania Polskiego Centrum Badań i Certyfikacji

Urządzenie powinno być zasilane z gniazda z przyłączonym obwodem ochronnym (gniazdo z kołkiem). Współpracujące ze sobą urządzenia (komputer, monitor, drukarka) powinny być zasilane z tego samego źródła.

Instalacja elektryczna pomieszczenia powinna zawierać w przewodzie fazowym rezerwową ochronę przed zwarciami, w postaci bezpiecznika o wartości znamionowej nie większej niż 16A (amperów).

W celu całkowitego wyłączenia urządzenia z sieci zasilania, należy wyjąć wtyczkę kabla zasilającego z gniazdka, które powinno znajdować się w pobliżu urządzenia i być łatwo dostępne.

Znak bezpieczeństwa "B" potwierdza zgodność urządzenia z wymaganiami bezpieczeństwa użytkownika zawartymi w PN-93/T-42107 i PN-89/E-06251.

Pozostałe instrukcje bezpieczeństwa

- Nie należy używać wtyczek adapterowych lub usuwać kołka obwodu ochronnego z wtyczki. Jeżeli konieczne jest użycie przedłużacza to należy użyć przedłużacza 3-żyłowego z prawidłowo połączonym przewodem ochronnym.
- System komputerowy należy zabezpieczyć przed nagłymi, chwilowymi wzrostami lub spadkami napięcia, używając eliminatora przepięć, urządzenia dopasowującego lub bezzakłóceniewego źródła zasilania.
- Należy upewnić się, aby nic nie leżało na kablach systemu komputerowego, oraz aby kable nie były umieszczone w miejscu, gdzie można byłoby na nie nadeptywać lub potykać się o nie.
- Nie należy rozlewać napojów ani innych płynów na system komputerowy.
- Nie należy wpychać żadnych przedmiotów do otworów systemu komputerowego, gdyż może to spowodować pożar lub porażenie prądem, poprzez zwarcie elementów wewnętrznych.
- System komputerowy powinien znajdować się z dala od grzejników i źródeł ciepła. Ponadto, nie należy blokować otworów wentylacyjnych. Należy unikać kładzenia luźnych papierów pod komputer oraz umieszczania komputera w ciasnym miejscu bez możliwości cyrkulacji powietrza wokół niego.

Electric, Magnetic and Electromagnetic Fields ("EMF")

- We manufacture and sell many products targeted at consumers, which, like any electronic apparatus, in general have the ability to emit and receive electromagnetic signals.
- One of our leading Business Principles is to take all necessary health and safety measures for our products, to comply with all applicable legal requirements and to stay well within the EMF standards applicable at the time of producing the products.
- We are committed to develop, produce and market products that cause no adverse health effects.
- We confirm that if its products are handled properly for their intended use, they are safe to use according to scientific evidence available today.
- We play an active role in the development of international EMF and safety standards, enabling us to anticipate further developments in standardization for early integration in its products.

SAFETY INFORMATION

Information for U.K. only

WARNING - THIS APPLIANCE MUST BE EARTHED.

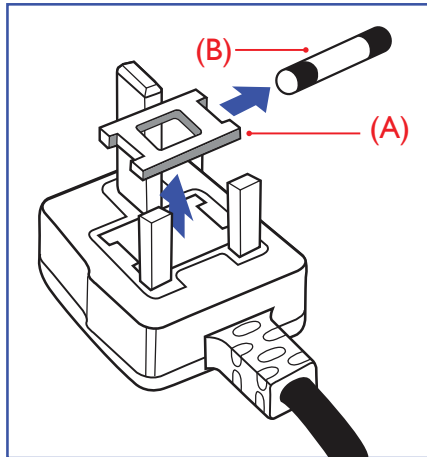

Important:

This apparatus is supplied with an approved moulded 13A plug. To change a fuse in this type of plug proceed as follows:

- 1 Remove fuse cover and fuse.
- 2 Fit new fuse which should be a BS 1362 5A, A.S.T.A. or BSI approved type.
- 3 Refit the fuse cover.

If the fitted plug is not suitable for your socket outlets, it should be cut off and an appropriate 3-pin plug fitted in its place.

If the mains plug contains a fuse, this should have a value of 5A. If a plug without a fuse is used, the fuse at the distribution board should not be greater than 5A.



Note:

The severed plug must be destroyed to avoid a possible shock hazard should it be inserted into a 13A socket elsewhere.

SAFETY INFORMATION

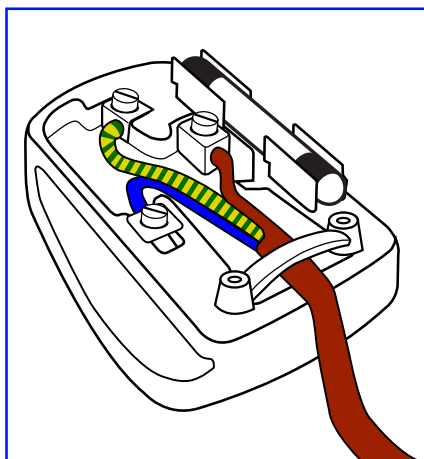

How to connect a plug

The wires in the mains lead are coloured in accordance with the following code:

BLUE - "NEUTRAL" ("N")

BROWN - "LIVE" ("L")

GREEN & YELLOW - "EARTH" ("E")

- The GREEN & YELLOW wire must be connected to the terminal in the plug which is marked with the letter "E" or by the Earth symbol or coloured GREEN or GREEN & YELLOW.
- The BLUE wire must be connected to the terminal which is marked with the letter "N" or coloured BLACK.
- The BROWN wire must be connected to the terminal which marked with the letter "L" or coloured RED.

Before replacing the plug cover, make certain that the cord grip is clamped over the sheath of the lead - not simply over the three wires.

North Europe (Nordic Countries) Information

Placering/Ventilation

WARNING: FÖRSÄKRA DIG OM ATT HUVUDBRYTARE OCH UTTAG ÄR LÄTÅTKOMLIGA, NÄR DU STÄLLER DIN UTRUSTNING PÅPLATS.

Placering/Ventilation

ADVARSEL: SØRG VED PLACERINGEN FOR, AT NETLEDNINGENS STIK OG STIKKONTAKT ER NEMT TILGÆNDELIGE.

Paikka/Ilmankierto

VAROITUS: SIJOITA LAITE SITEN, ETTÄ VERKKOJOHTO VOIDAAN TARVITTAESSA HELPOSTI IRROTTAA PISTORASIESTA.

Plassering/Ventilasjon

ADVARSEL: NÅR DETTE UTSTYRET PLASSERES, MÅ DU PASSE PÅ AT KONTAKTENE FOR STØMTILFØRSEL ER LETTE Å NÅ.

SAFETY INFORMATION

End-of-Life Disposal

Your new Public Information Display contains materials that can be recycled and reused. Specialized companies can recycle your product to increase the amount of reusable materials and to minimize the amount to be disposed of.

Please find out about the local regulations on how to dispose of your old display from your local dealer.

(For customers in Canada and U.S.A.)

This product may contain lead and/or mercury. Dispose of in accordance to local-state and federal regulations. For additional information on recycling contact www.eia.org (Consumer Education Initiative).

Waste Electrical and Electronic Equipment-WEEE

Attention users in European Union private households



Disposal of Waste Equipment by Users in Private Household in the European Union.

This symbol on the product or on its packaging indicates that this product must not be disposed of with your other household waste. Instead, it is your responsibility to dispose of your waste equipment by handing it over to a designated collection point for the recycling of waste electrical and electronic equipment. The separate collection and recycling of your waste equipment at the time of disposal will help to conserve natural resources and ensure that it is recycled in a manner that protects human health and the environment. For more information about where you can drop off your waste equipment for recycling, please contact your local city office, your household waste disposal service or the shop where you purchased the product.

For Private Households in the European Union. To help conserve natural resources and ensure the product is recycled in a manner that protects human health and the environment, we would like to bring your attention to the following:

- The crossed-out dustbin on the device or outer packaging indicates the product is compliant with European WEEE (Waste Electrical and Electronic Equipment) Directive.
- Always dispose of the old devices separately from household waste.
- Batteries should be removed beforehand and disposed separately to the right collection system.
- You are responsible with regard to the deletion of personal data on old devices before disposal.
- Private households can hand in their old devices free of charge.
- For more information about where you can drop off your waste equipment for recycling, please contact your local city office, your household waste disposal service or the shop where you purchased the product.

Attention users in United States:

Please dispose of according to all Local, State and Federal Laws. For the disposal or recycling information, contact: www.mygreenelectronics.com or www.eiae.org.

SAFETY INFORMATION

End of Life Directives-Recycling



Your new Public Information Display contains several materials that can be recycled for new users.

Please dispose of according to all Local, State, and Federal laws.

Restriction on Hazardous Substances statement (India)

This product complies with the “India E-waste Rule 2011” and prohibits use of lead, mercury, hexavalent chromium, polybrominated biphenyls or polybrominated diphenyl ethers in concentrations exceeding 0.1 weight % and 0.01 weight % for cadmium, except for the exemptions set in Schedule 2 of the Rule.

E-Waste Declaration for India



This symbol on the product or on its packaging indicates that this product must not be disposed of with your other household waste. Instead it is your responsibility to dispose of your waste equipment by handing it over to a designated collection point for the recycling of waste electrical and electronic equipment . The separate collection and recycling of your waste equipment at the time of disposal will help to conserve natural resources and ensure that it is recycled in a manner that protects human health and the environment.

Batteries



For EU: The crossed-out wheeled bin implies that used batteries should not be put to the general household waste! There is a separate collection system for used batteries, to allow proper treatment and recycling in accordance with legislation.

Please contact your local authority for details on the collection and recycling schemes.

For Switzerland: The used battery is to be returned to the selling point.

For other non-EU countries: Please contact your local authority for correct method of disposal of the used battery.

According to EU directive 2006/66/EC, the battery can't be disposed improperly. The battery shall be separated to collect by local service.

Turkey RoHS

Türkiye Cumhuriyeti: EEE Yönetmeliğine Uygundur.

Ukraine RoHS

Обладнання відповідає вимогам Технічного регламенту щодо обмеження використання деяких небезпечних речовин в електричному та електронному обладнанні, затвердженого постановою Кабінету Міністрів України від 3 грудня 2008 № 1057.

PRECAUTIONS

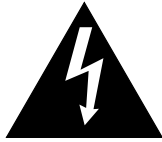

Symbols used in this manual

	This icon indicates the existence of a potential hazard that could result in personal injury or damage to the product.
	This icon indicates important operating and servicing information.

Notice

- Read this User Manual carefully before using the LCD display and keep it for future reference.
- The product specifications and other information provided in this User Manual are for reference only. All information is subject to change without notice. Updated content can be downloaded from our web site at www.agneovo.com.
- To protect your rights as a consumer, do not remove any stickers from the LCD display. Doing so may affect the determination of the warranty period.

Cautions When Setting Up

- Do not place the LCD display near heat sources, such as a heater, exhaust vent, or in direct sunlight.
- Do not cover or block the ventilation holes in the housing.
- Place the LCD display on a stable area. Do not place the LCD display where it may subject to vibration or shock.
- Place the LCD display in a well-ventilated area.
- Do not place the LCD display outdoors.
- To avoid the risk of shock or permanent damage to the set, do not expose the display to dust, rain, water or an excessively moist environment.
- Do not spill liquid or insert sharp objects into the LCD display through the ventilation holes. Doing so may cause accidental fire, electric shock or damage the LCD display.

PRECAUTIONS

Cautions When Using

- Use only the power cord supplied with the LCD display.
- The power outlet should be installed near the LCD display and be easily accessible.
- If an extension cord is used with the LCD display, ensure that the total current consumption plugged into the power outlet does not exceed the ampere rating.
- Do not allow anything to rest on the power cord. Do not place the LCD display where the power cord may be stepped on.
- If the LCD display will not be used for an indefinite period of time, unplug the power cord from the power outlet.
- To disconnect the power cord, grasp and pull by the plug head. Do not tug on the cord; doing so may cause fire or electric shock.
- Do not unplug or touch the power cord with wet hands.
- When turning off the display by detaching the power cord, wait 6 seconds before re-attaching the power cord for normal operation.
- Do not knock or drop the display during operation or transportation.

Cleaning and Maintenance

- To protect your display from possible damage, do not put excessive pressure on the LCD panel. When moving your display, grasp the frame to lift; do not lift the display by placing your hand or fingers on the LCD panel.
- Unplug the display if you need to clean it with a slightly damp cloth. The screen may be wiped with a dry cloth when the power is off. However, never use organic solvent, such as, alcohol, or ammonia-based liquids to clean your display.
- If your display becomes wet, wipe it with dry cloth as soon as possible.
- If a foreign substance or water gets in your display, turn the power off immediately and disconnect the power cord. Then remove the foreign substance or water, and send the unit to the maintenance center.
- In order to maintain the best performance of your display and ensure a longer lifetime, we strongly recommend using the display in a location that falls within the following temperature and humidity ranges.
 - ◆ Temperature: 0-40°C (32-104°F)
 - ◆ Humidity: 20-80% RH



Warning:



Unplug the power cord from the power outlet and refer to qualified service

personnel under the following conditions:

- ◆ When the power cord is damaged.
- ◆ If the LCD display has been dropped or the housing has been damaged.
- ◆ If the LCD display emits smoke or a distinct odor.

PRECAUTIONS

Notice for the LCD Display

- In order to maintain the stable luminous performance, it is recommended to use low brightness setting.
- Due to the lifespan of the lamp, it is normal that the brightness quality of the LCD display may decrease with time.
- When static images are displayed for long periods of time, the image may cause an imprint on the LCD display. This is called image retention or burn-in.
 - ◆ To prevent image retention, do any of the following:
 - Set the LCD display to turn off after a few minutes of being idle.
 - Use a screen saver that has moving graphics or a blank white image.
 - Execute the Anti-Burn-in™ function of the LCD display. See **Setting > Advanced Options > Anti-Burn-in** section.
 - Switch desktop backgrounds regularly.
 - Adjust the LCD display to low brightness settings.
 - Turn off the LCD display when the system is not in use.
 - ◆ Things to do when the LCD display shows image retention:
 - Turn off the LCD display for extended periods of time. It can be several hours or several days.
 - Use a screen saver and run it for extended periods of time.
 - Use a black and white image and run it for extended periods of time.
- There are millions of micro transistors inside the LCD display. It is normal for a few transistors to be damaged and to produce spots. This is acceptable and is not considered a failure.
- **IMPORTANT:** Always activate a moving screen saver program when you leave your display unattended. Always activate a periodic screen refresh application if the unit will display unchanging static content. Uninterrupted display of still or static images over an extended period may cause “burn in”, also known as “after-imaging” or “ghost imaging”, on your screen. This is a well-known phenomenon in LCD panel technology. In most cases, the “burned in” or “after-imaging” or “ghost imaging” will disappear gradually over a period of time after the power has been switched off.
- **WARNING:** Severe “burn-in” or “after-image” or “ghost image” symptoms will not disappear and cannot be repaired. This is also not covered under the terms of your warranty.

CHAPTER 1: PRODUCT DESCRIPTION

1.1 Unpacking

- This product is packed in a packaging box which contains standard accessories.
- Any other optional accessories will be packed separately.
- Considering the size and weight of the display, it is recommended that this product is carried out by two persons.
- After opening the packaging box, ensure that the included items are in good condition and complete.

1.2 Package Contents

When unpacking, check if the following items are included in the package. If any of them is missing or damaged, contact your dealer.

LCD Display



Remote control

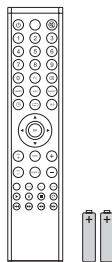

Quick Start Guide



HDMI cable

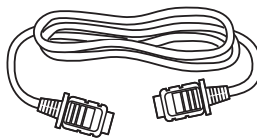

Power cord

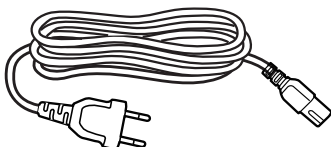

Note:

- ◆ Remote control is shipped with the supplied AAA batteries.
- ◆ For all other regions, apply a power cord that conforms to the AC voltage of the power socket and has been approved by and complies with the safety regulations of the particular country (Type H05W-F, 2G or 3G, 0.75 or 1 mm² should be used).
- ◆ You might like to save the package box and packing material for shipping the display.
- ◆ The pictures are for reference only. Actual items may vary upon shipment.

PRODUCT DESCRIPTION

1.3 Preparing for the Installation

- Due to the high power consumption, always use the plug exclusively designed for this product. If an extended line is required, please consult your service agent.
- The product should be installed on a flat surface to avoid tipping. The distance between the back of the product and the wall should be maintained for proper ventilation. Avoid installing the product in the kitchen, bathroom or any other places with high humidity so as not to shorten the service life of the electronic components.
- The product can normally operate only under 3000m in altitude. In installations at altitudes above 3000m, some abnormalities may be experienced.

1.4 Wall Mounting Installation

To mount this display to a wall, you will have to obtain a standard wall-mounting kit (commercially available). We recommend using a mounting interface that complies with TUV-GS and/or UL1678 standard in North America.

To wall-mount the LCD display, screw the mounting bracket to the VESA holes at the rear of the LCD display.

HMQ-4301

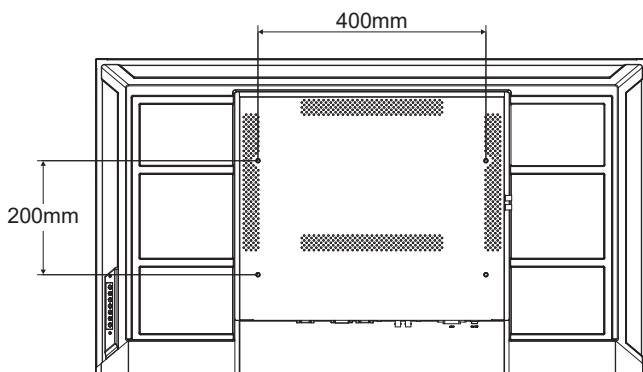

HMQ-5501

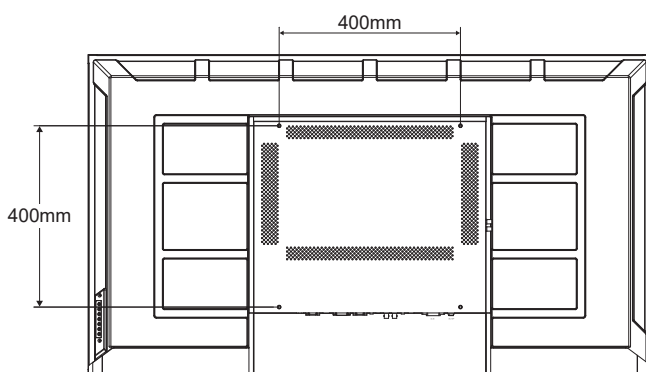

Warning:

- ◆ Do not press too hard on the LCD panel or edge of the frame, as this may cause the device to malfunction.

Note:

- ◆ Avoid the wall-mounting kit to block the ventilation holes on the back of the display.
- ◆ Secure the LCD display on a solid wall strong enough to bear its weight.
- ◆ Lay a protective sheet on a table, which was wrapped around the display when it was packaged, beneath the screen surface so as not to scratch the screen face.
- ◆ Ensure you have all accessories for mounting this display (wall mount, ceiling mount, etc).
- ◆ Follow the instructions that come with the base mounting kit. Failure to follow correct mounting procedures could result in damage to the equipment or injury to the user or installer. Product warranty does not cover damage caused by improper installation.

PRODUCT DESCRIPTION

HMQ-6501

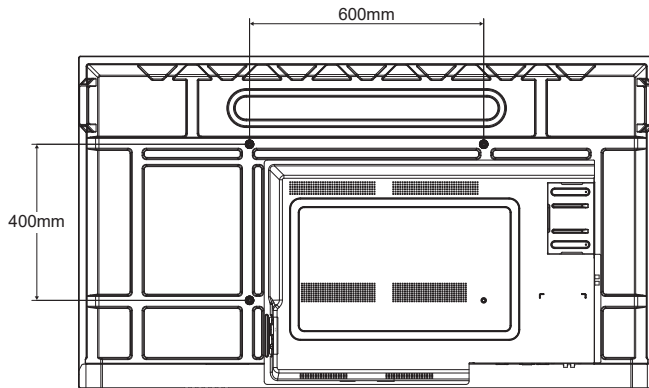

1.4.1 VESA Grid

Model Name	VESA Grid
HMQ-4301	400(W) x 200(H) mm
HMQ-5501	400(W) x 400(H) mm
HMQ-6501	600(W) x 400(H) mm

Caution:

To prevent the display from falling:

- ◆ For wall or ceiling installation, we recommend installing the display with metal brackets which are commercially available. For detailed installation instructions, see the guide received with the respective bracket.
- ◆ To lessen the probability of injury and damage resulting from fall of the display in case of earthquake or other natural disaster, be sure to consult the bracket manufacturer for installation location.

1.4.2 Ventilation Requirements for Enclosure Locating

To allow heat to disperse, leave space between surrounding objects as shown in the diagram below.

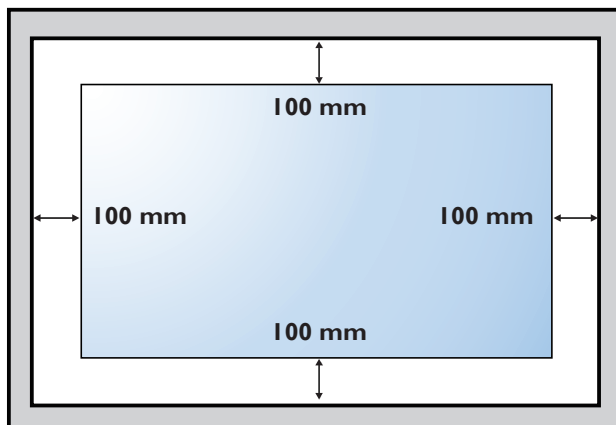

Note:

- ◆ For the wall-mounting kit, use M6 mounting screws (having a length 10 mm longer than the thickness of the mounting bracket) and tighten them securely.

PRODUCT DESCRIPTION

1.5 LCD Display Overview

1.5.1 Control Panel

HMQ-4301/5501

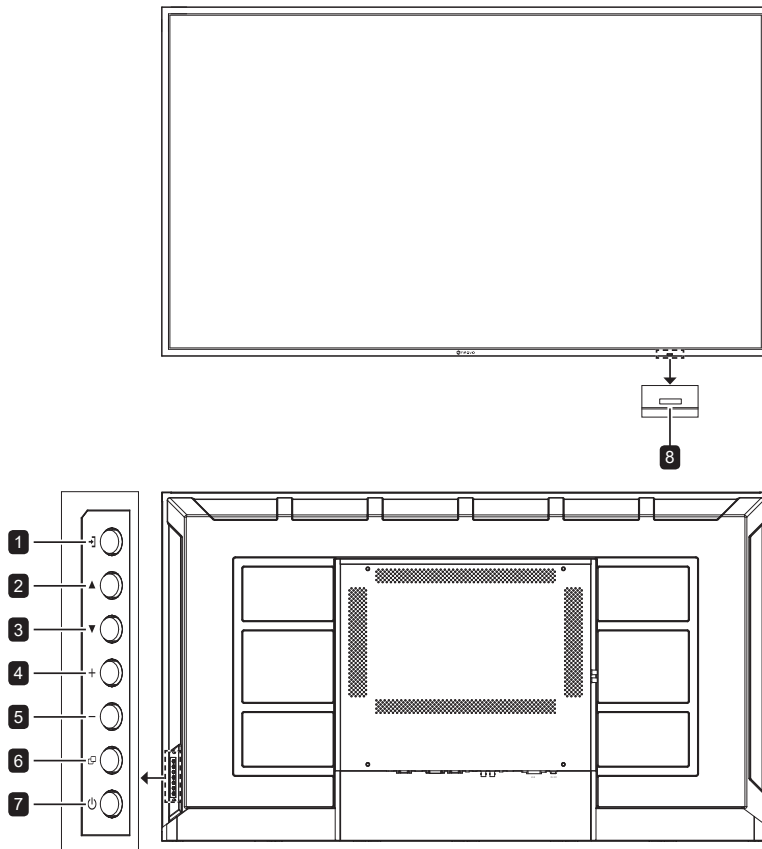

- 1** **[↔] Input**
Choose the input source.
- 2** **[▲] Up**
Move the highlight bar up to select an option or increase the adjustment while OSD menu is on.
- 3** **[▼] Down**
Move the highlight bar down to select an option or decrease the adjustment while OSD menu is on.
- 4** **[+] Increase**
 - Select an option or increase the adjustment while OSD menu is on.
 - Increase the audio output level while OSD menu is off.
- 5** **[-] Decrease**
 - Select an option or decrease the adjustment while OSD menu is on.
 - Decrease the audio output level while OSD menu is off.

HMQ-6501

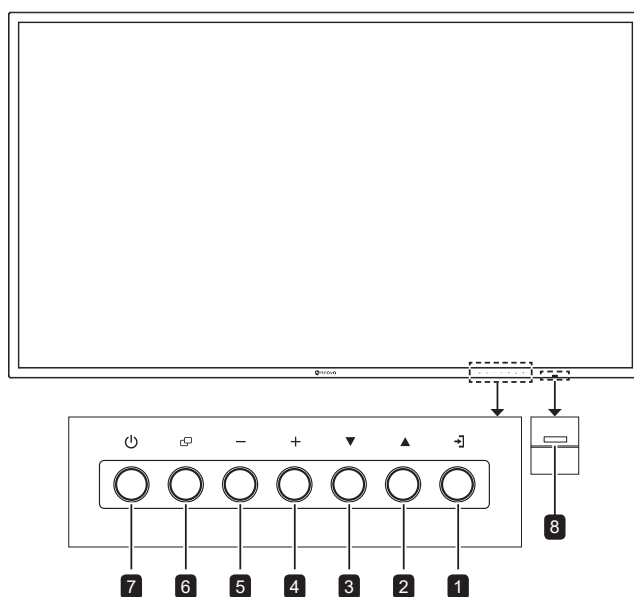

- 6** **[☰] Menu**
 - Activate the OSD menu when OSD menu is off.
 - Return to the previous menu or hide the OSD menu while OSD menu is on.
- 7** **[⏻] Power**
Turn the display on or put the display to standby.
- 8** **Remote control sensor and power status indicator**
 - Receive command signals from the remote control.
 - Indicate the operating status of the display:
 - Lights green when the display is turned on
 - Blinks amber when the display is in standby mode
 - Lights off when the main power of the display is turned off

PRODUCT DESCRIPTION

1.5.2 Input/Output Terminals

HMQ-4301/5501

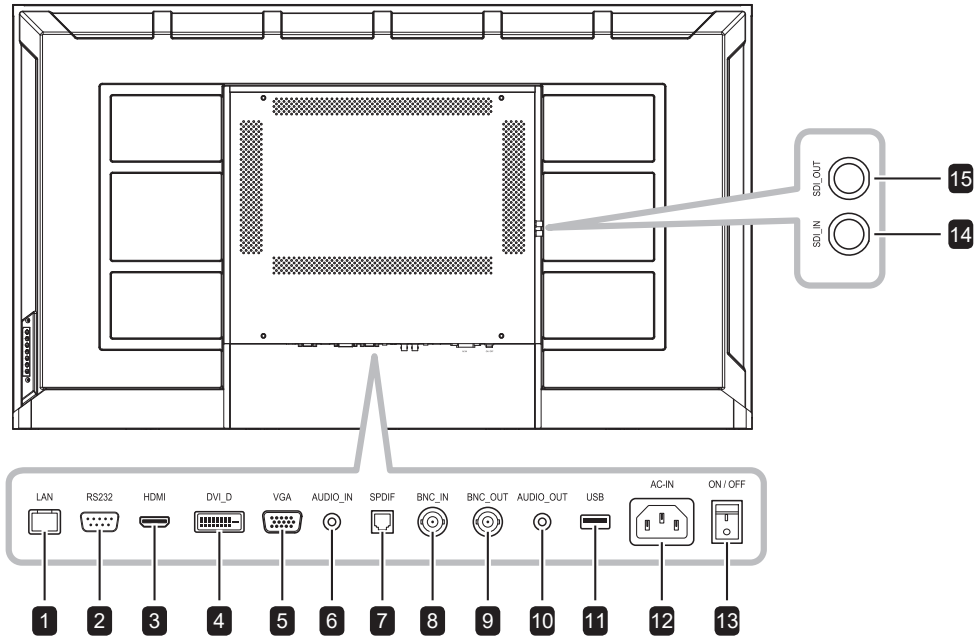

HMQ-6501

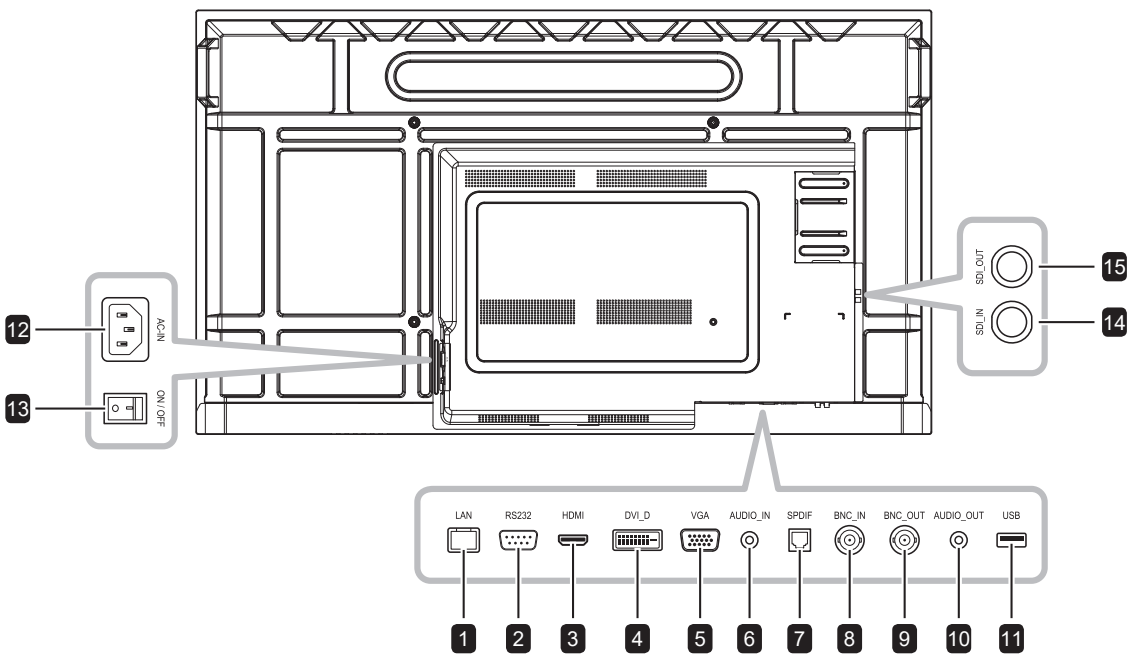

PRODUCT DESCRIPTION

- 1 LAN**
For LAN connection with an Ethernet cable.
- 2 RS232**
Connect RS232 input from external equipment.
- 3 HDMI**
Connect HDMI signals input.
- 4 DVI_D**
Connect DVI signals input.
- 5 VGA**
Connect VGA signals input.
- 6 AUDIO_IN**
Connect audio signals input
(3.5 mm Stereo Audio Jack).
- 7 SPDIF**
Connect digital audio signals output.
- 8 BNC_IN**
Connect BNC signals input.
- 9 BNC_OUT**
Connect BNC signals output.
- 10 AUDIO_OUT**
Connect audio signals output
(3.5 mm Stereo Audio Jack).
- 11 USB**
USB Port for firmware upgrade.
- 12 AC-IN**
AC power input.
- 13 ON / OFF**
Switch the main power on/off.
- 14 SDI_IN**
Connect SDI signals input.
- 15 SDI_OUT**
Connect SDI signals output.

PRODUCT DESCRIPTION

1.6 Remote Control

1.6.1 General Functions

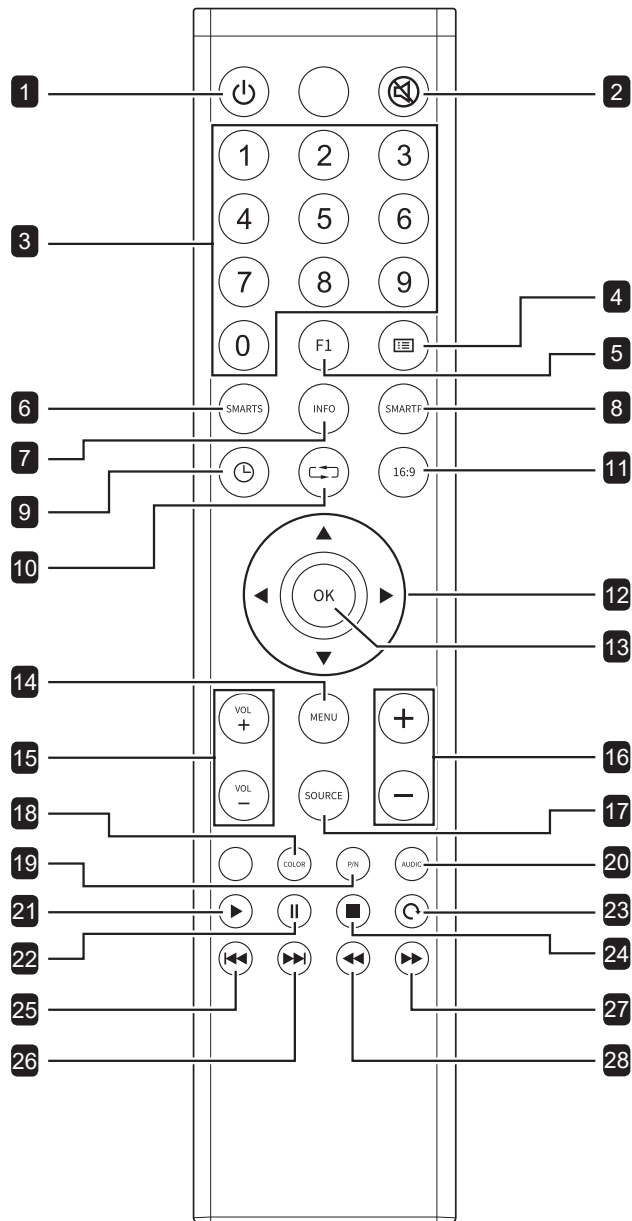

- 1 [POWER] POWER**
Turns the display on or puts the display into standby mode.
- 2 [MUTE] MUTE**
Turns the mute function on/off.
- 3 [Number]**
Inputs numbers.
- 4 [List] List**
No function.
- 5 [F1] Freeze**
Freezes or unfreezes the screen image.
- 6 [SMARTS] Sound Mode**
Selects the preferred sound mode. The available sound modes include: **Standard, Rock, POP, Jazz, Classical, and Custom.**
- 7 [INFO]**
Displays signal type and resolution.
- 8 [SMARTP] Picture Mode**
Selects the preferred picture mode. The available sound modes include: **Standard, Vivid, Soft, CCTV, and Movie.**
- 9 [Timer]**
No function.
- 10 [Back]**
Exits from the previous function.
- 11 [16:9] Aspect Ratio**
Changes the aspect ratio.
- 12 [▲ ▼ ◀ ▶] Navigation Buttons**
Navigates through menus and chooses items.
- 13 [OK]**
Confirms an entry or selection.
- 14 [MENU]**
Accesses the OSD menu.
- 15 [VOL + / -] Volume Button**
Adjusts volume on internal or external audio sources.
- 16 [+/-]**
No function.
- 17 [SOURCE]**
Selects the input source. Press the [▲] or [▼] button to choose from HDMI, DVI, VGA, CVBS, and SDI.
- 18 [COLOR] Colour Temperature**
Selects the colour temperature.
- 19 ~ 28**
No function.

PRODUCT DESCRIPTION

1.6.2 Inserting the Batteries in the Remote Control

The remote control is powered by two 1.5V AAA batteries.

To install or replace batteries:

- 1 Press and then slide the cover to open it.
- 2 Align the batteries according to the (+) and (-) indications inside the battery compartment.
- 3 Replace the cover.

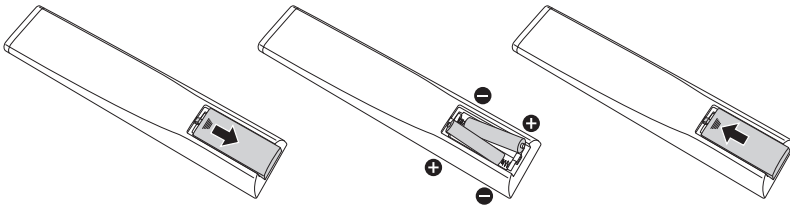

1.6.3 Handling the Remote Control

- Do not subject to strong shock.
- Do not allow water or other liquid to splash the remote control. If the remote control gets wet, wipe it dry immediately.
- Avoid exposure to heat and steam.
- Other than to install the batteries, do not open the remote control.

Caution:

The incorrect use of batteries can result in leaks or bursting. Be sure to follow these instructions:

- ◆ Place “AAA” batteries matching the (+) and (-) signs on each battery to the (+) and (-) signs of the battery compartment.
- ◆ Do not mix battery types.
- ◆ Do not combine new batteries with used ones. It causes shorter life or leakage of batteries.
- ◆ Remove the dead batteries immediately to prevent them from liquid leaking in the battery compartment. Don't touch exposed battery acid, as it can damage your skin.

Note:

- ◆ If you do not intend to use the remote control for a long period, remove the batteries.
- ◆ The remote control may not function properly when the remote control sensor on this display is under direct sunlight or strong illumination, or when there is an obstacle in the path of signal transmission.

PRODUCT DESCRIPTION

1.6.4 Operating Range of the Remote Control

Point the top of the remote control toward the display's remote control sensor (on the right side) when pressing a button.

When using the remote control, the distance from the remote control to the sensor on the display should be less than 8m/26ft, and the horizontal and vertical angles should be less than 30°.

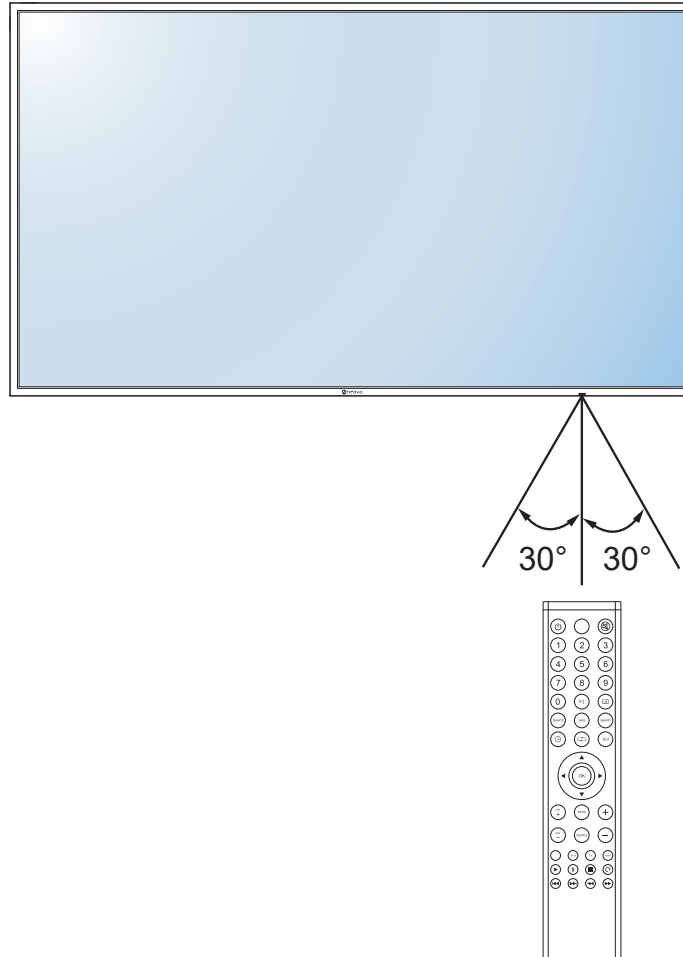



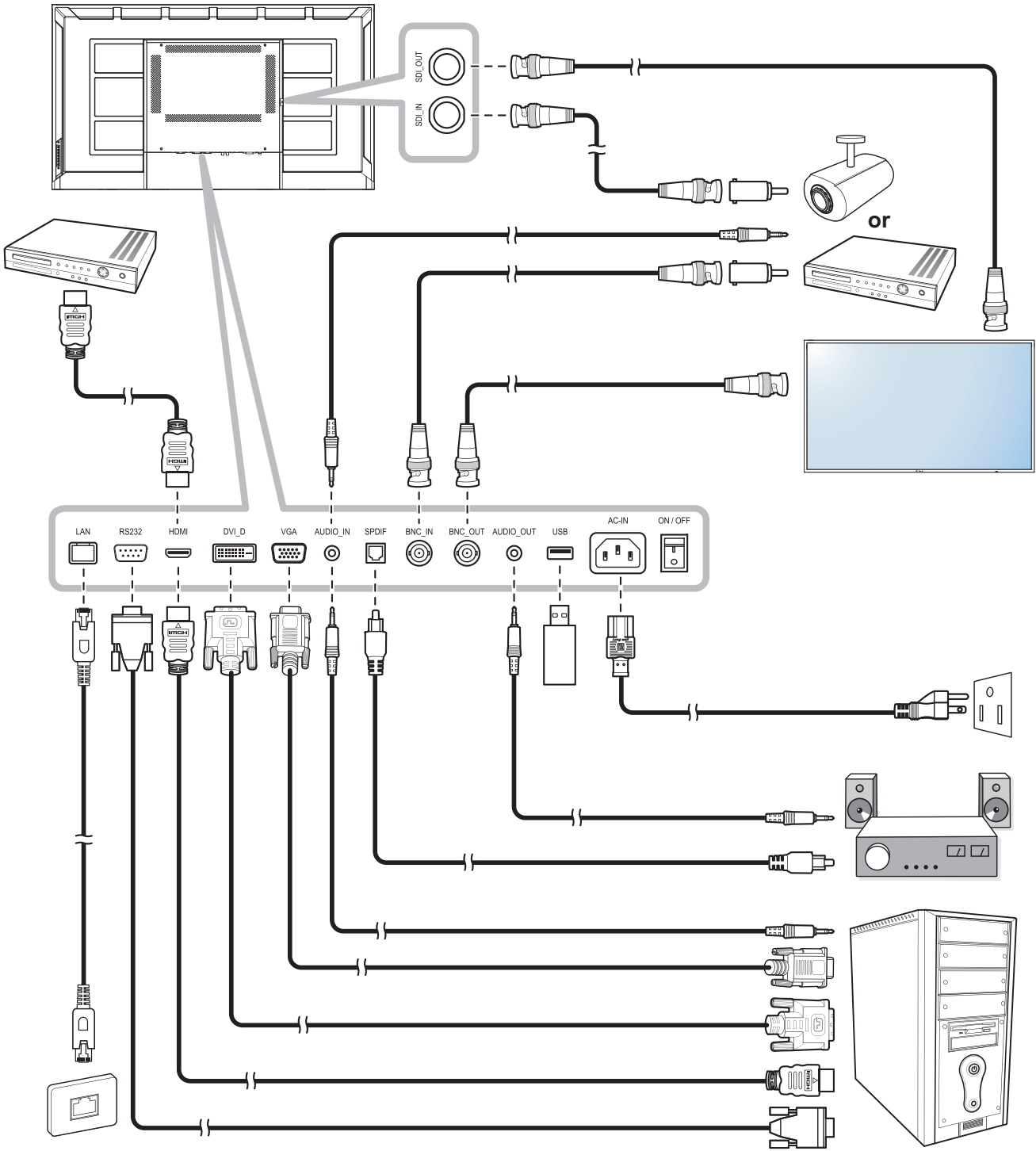

CHAPTER 2: MAKING CONNECTIONS



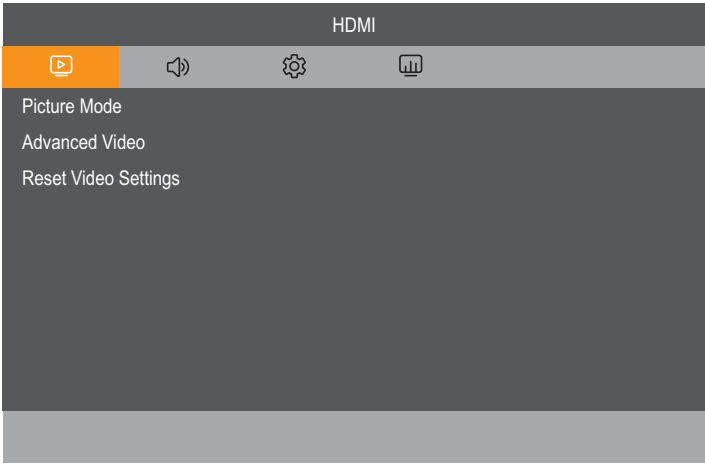

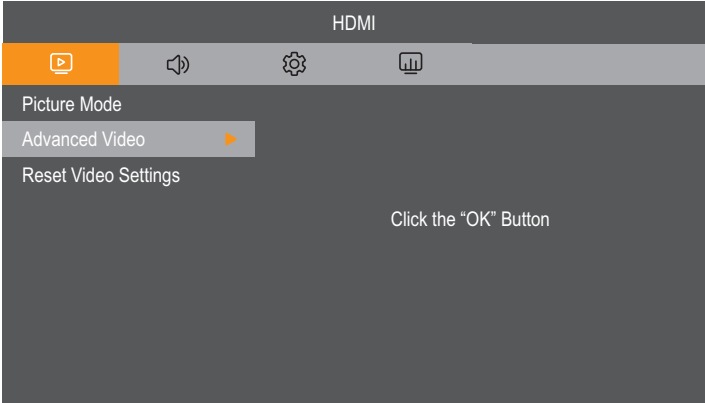
CHAPTER 3: ON SCREEN DISPLAY MENU

3.1 Using the OSD Menu

#	Menu Navigation	Operation	
		Control Panel	Remote Control
1	<p>Display the main menu screen.</p> 	<p>1 Press the  button.</p> <p>2 Press the + or - button to select the menu item.</p>	<p>1 Press the MENU button.</p> <p>2 Press the ◀ or ▶ button to select the menu item.</p>
2	<p>Enter the submenu.</p>  <p>The highlighted item (light gray) indicates the active submenu.</p>	<p>1 Press the ▲ or ▼ button to enter the submenu.</p> <p>2 Press the  button to select an item to be adjusted.</p>	<p>1 Press the ▲ or ▼ button to enter the submenu.</p> <p>2 Press the OK button to select an item to be adjusted.</p>
3	<p>Select the setting or adjust the value.</p> 	<p>1 Press the  button to select an item to be adjusted.</p> <p>2 Press the ▲/▼ or +/- button to select the setting or change the value.</p>	<p>1 Press the OK button to select an item to be adjusted.</p> <p>2 Press the ▲/▼ or ◀/▶ button to select the setting or change the value.</p>
4	<p>Exit the submenu.</p>	<p>Press the  button to return to the previous menu.</p>	<p>Press the MENU button to return to the previous menu.</p>

ON SCREEN DISPLAY MENU

#	Menu Navigation	Operation	
		Control Panel	Remote Control
5	Close the OSD window.	Press  button for several times if necessary to exit.	Press the  button once or the MENU button for several times if necessary to exit.

When settings are modified, usually all changes are saved when the user does the following:

- Proceeds to the another menu.
- Exits the OSD menu.
- Waits for the OSD menu to disappear.

Note:

- ◆ Availability of some menu items depend on the input source signal. If the menu is not available, it is disabled and grayed out.

ON SCREEN DISPLAY MENU

3.2 OSD Menu Tree

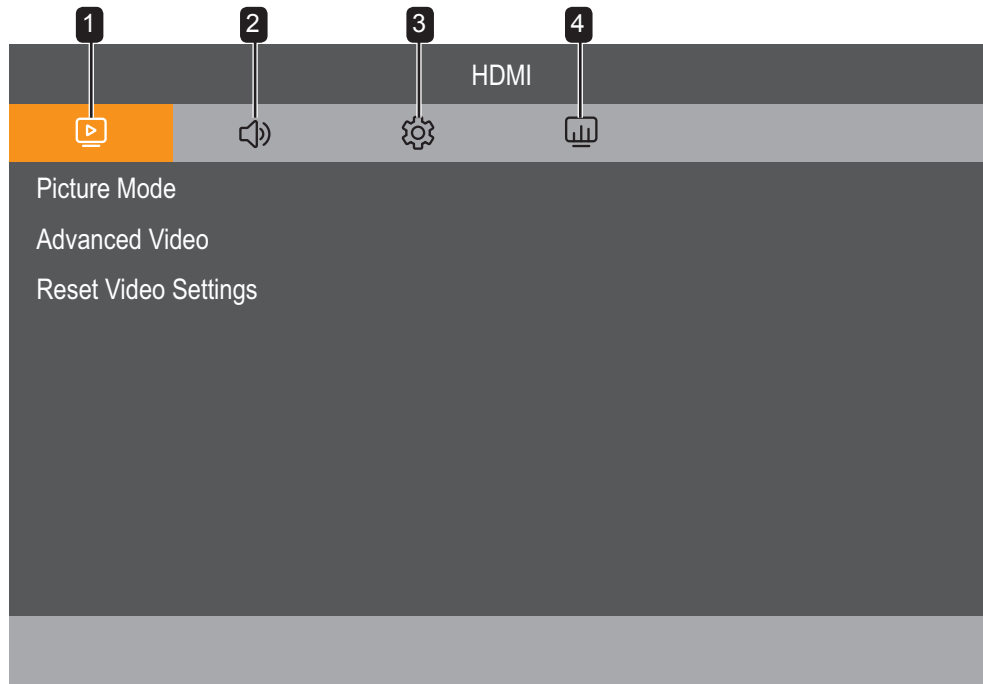

Main Menu	Submenu	Remarks
1. Picture	<ul style="list-style-type: none"> • Picture Mode • Advanced Video • Reset Video Setting 	See page 23.
2. Sound	<ul style="list-style-type: none"> • Sound Mode • Balance • Surround • Internal Speakers • Digital Output • Audio Delay • Audio Source • Sound Mute • Reset Audio Settings 	See page 26.
3. Settings	<ul style="list-style-type: none"> • OSD Settings • Power Settings • Audio Signal Detection • HDMI Settings • VGA Options • Advanced Options • Monitor Information • Factory Reset 	See page 28.
4. Network	<ul style="list-style-type: none"> • Control Interface • Network Settings • Monitor ID • Reset Network Settings 	See page 32.

CHAPTER 4: ADJUSTING THE LCD DISPLAY

4.1 Picture

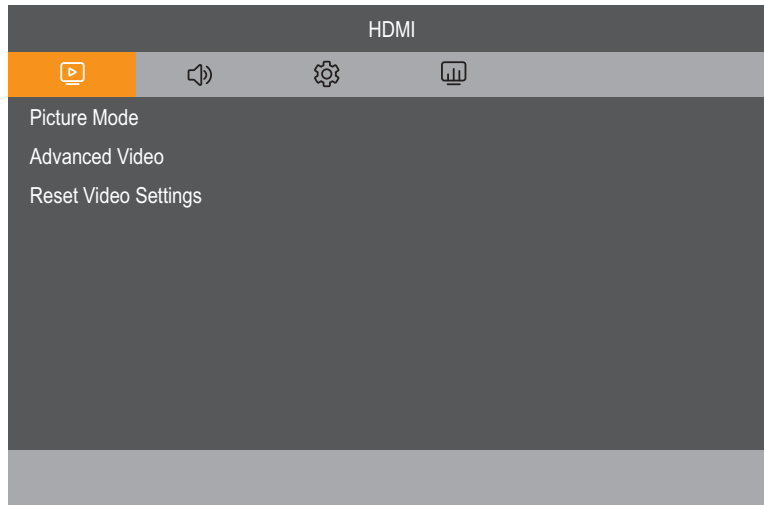

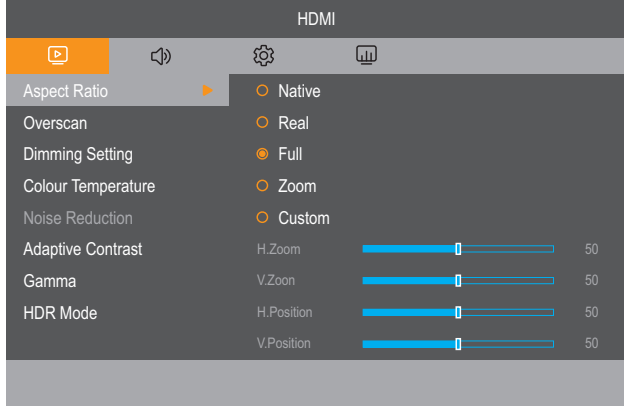

Item	Function	Range
Picture Mode		
	Picture Mode: Sets the predefined picture setting.	Standard Vivid Soft CCTV Movie
Brightness	Brightness: Adjusts the luminance of the screen image.	0 to 100
	<p>Original Setting High Setting Low Setting</p>	
Contrast	Contrast: Adjusts the difference between the black level and the white level.	0 to 100
	<p>Original Setting High Setting Low Setting</p>	

ADJUSTING THE LCD DISPLAY

Item	Function	Range
Picture Mode	Hue: Adjusts the colour balance of red and green	0 to 100
	Saturation: Adjust the colour saturation of the picture.	0 to 100
	Sharpness: Adjusts the clarity and focus of the screen image.	0 to 100
	Black level: Adjusts the black level of the screen image. Low brightness setting makes black colour darker.	0 to 100
Advanced video		
	Aspect Ratio: Adjusts the aspect ratio of the screen image.	Native Real Full Zoom Custom
	Note: <ul style="list-style-type: none"> To adjust manually the value of horizontal zoom (H. Zoom), vertical zoom (V. Zoom), horizontal position (H. Position), and vertical position (V. Position), set the aspect ratio to Custom. H. Position and V. Position can be adjusted only if the source is VGA. 	0 to 100
	Overscan: Adjusts the overscan setting to fix the cut-off screen edges.	0 to 25
	Dimming Setting: Enables or disables adjusting the backlight brightness. If dimming is set to Dynamic Backlight then this features adjusts the backlight brightness to optimize the dynamic power consumption and screen contrast.	Off Dynamic Backlight
	Colour Temperature: Selects a colour temperature for the image. A lower colour temperature will have a reddish tint, whilst a higher colour temperature gives off a more bluish tint.	Cool Normal Warm Native User
	Note: To adjust independently the value of red, green, and blue, set the colour temperature to User .	0 to 255
	Noise Reduction: Removes noise from the images. This feature helps to produce clearer and crisper images. Note: This menu item is only available if the input source is CVBS.	Off Low Mid High

ADJUSTING THE LCD DISPLAY

Item	Function		Range
Advanced Video	<div style="display: flex; justify-content: space-around;"> <div style="text-align: center;"> <p><i>Noise Reduction Off</i></p>  </div> <div style="text-align: center;"> <p><i>Noise Reduction On</i></p>  </div> </div>		
	<p>Adaptive Contrast: Optimizes automatically the contract ratio of the LCD display in dark scenes as well as delivers smoother and more realistic gradients.</p> <p>Note: Use this function in HDMI source when the signal format is YUV.</p>		Off Low Mid High
	<p>Gamma: Adjusts the non-linear setting for picture luminance and contrast.</p>		Native 2.2 2.4
	<p>High dynamic range (HDR) Mode: Displays more realistically colour tones and more details in light and dark environments.</p> <p>Note: Use this function in HDMI-HDR source when the signal format is YUV4:4:4.</p>		Off Low Mid High
	<p>Reset Video Setting: Resets all settings in the Picture menu to the factory preset values.</p>		Yes No

ADJUSTING THE LCD DISPLAY

4.2 Sound

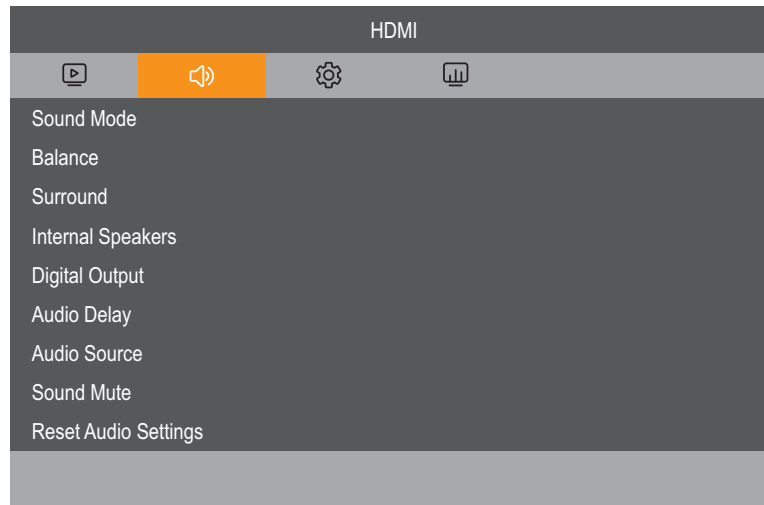

Item	Function	Range
Sound Mode		
	Sets the predefined Sound Mode.	Standard Rock POP Jazz Classical Custom
	Note: To adjust sound settings (120Hz, 500Hz, 1.5KHz, 5KHz, and 10KHz) manually, set the sound mode to User .	0 to 100
Balance	Adjusts to emphasize left or right audio output balance.	L50 to 0 0 to R50
Surround	Provides an enhanced listening experience.	Off On
Internal Speakers	Enables or disables internal speakers.	Off On
Digital Output	Selects the digital output format.	RAW PCM
Audio Delay	Sets the internal speaker audio delay.	0 to 100
Audio Source	Selects the audio input source. Without video signal there is no audio output. <ul style="list-style-type: none"> Analog: Audio from audio input. Digital: Audio from HDMI/DVI-HDMI audio. 	Analog Digital

ADJUSTING THE LCD DISPLAY

Item	Function	Range
Sound Mute	Turns the mute function on/off.	Off On
Reset Audio Settings	Resets all settings in the Sound menu to the factory preset values.	Yes No

ADJUSTING THE LCD DISPLAY

4.3 Setting

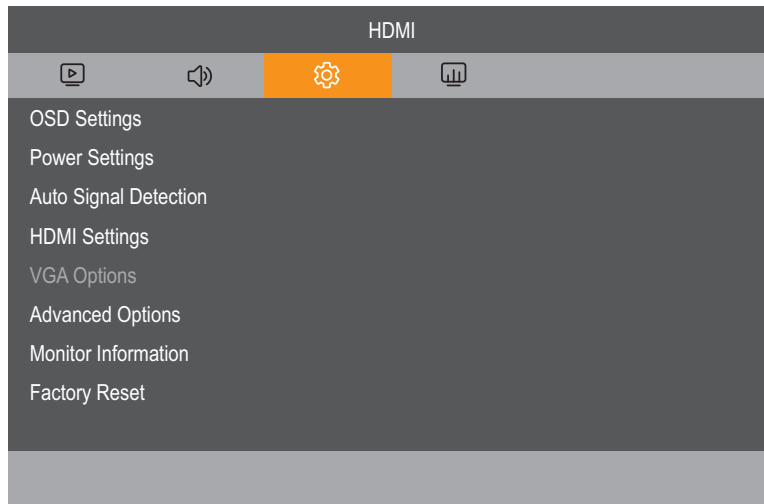





Item	Function	Range
OSD Settings	Language: Sets the OSD language.	English 简体中文 French Español Deutsch 繁體中文
	Transparency: Adjusts OSD transparency. • Off: Transparency is off. • 25% to 75%: Transparency level is 25% to 75%.	Off 25% 50% 75%
	Information OSD: Sets the period of time the information OSD is displayed on the upper right corner of the screen. The information OSD will appear on the screen when the input signal is changed. The information OSD will remain on the screen if the setting is set to Off .	Off On
	OSD Turn off: Sets the period of time the OSD menu stays on the screen.	0 to 100
Power Settings	Standby: Sets standby mode when DC is off.	Off 10 seconds 30 seconds 1 minute 5 minutes 10 minutes
	Quick Start: The LCD display is fully on but the backlight is off. The device can be woken up on signal detection.	Off On
	VPM: Enables the VPM feature to wake up the monitor from the standby mode.	Off On
	Note: This menu item is only available if the input source is SDI.	

ADJUSTING THE LCD DISPLAY

Item	Function	Range
Power Settings	<p>Switch on state: Selects the display status used for the next time you connect the power cord.</p> <ul style="list-style-type: none"> • Power Off: The display will remain off when the power cord is connected to a wall outlet. • Force on: The display will turn on when the power cord is connected to a wall outlet. • Last status: The display will return to the previous power status (on/off/standby) when removing and replacing the power cord. 	Power off Force on Last status
Auto Signal Detection	<p>Enables or disables the device to detect and display from available video inputs automatically.</p> <p>This function takes place only if there is no signal connected at the input port you designate for auto-detection.</p> <p>Off: Auto signal detection is disabled.</p> <p>Auto: The system will automatically search the available input signal in the following order: HDMI, DVI, VGA, CVBS, and SDI.</p>	Off Auto
HDMI Settings Note: HDMI Settings are available only for the HDMI source.	<p>Alink(CEC): Enables or disables configuring the HDMI Consumer Electronics Control settings.</p> <p>Off: Alink feature is off.</p> <p>On: Enables to scan for compatible devices and configures Auto Turn Off, Audio Receiver, and Device List settings.</p>	Off On
	<p>HDMI Version: Set the HDMI version to 1.2, 1.4, or 2.0.</p> <p>Note: HDMI 1.2 supports up to FHD 1080, HDMI 1.4 up to 4K@30Hz, and HDMI 2.0 up to 4K@60Hz.</p>	HDMI 1.2 HDMI 1.4 HDMI 2.0
	<p>Colour Range: Adjusts black and white levels for video.</p>	Auto Raw Signal Expanded Signal
	<p>HPD Enable: Enables or disables the HPD (hot-plug-detect) feature.</p>	Off On
	<p>Auto Adjust: Automatically optimizes the display of VGA input image.</p> <p>Note: Auto adjusting starts automatically every time you switch to the VGA source.</p>	N/A
VGA Options Note: VGA Options are available only for the VGA source.	<p>H.Position: Moves the image to the right or left.</p>	L50 to 0 0 to R50
	<p>V.Position: Moves the image up or down.</p>	L50 to 0 0 to R50
	<p>Clock: Adjusts the width of the image.</p>	0 to 100
	<p>Phase: Adjusts to improve the focus, clarity, and stability of the image.</p>	0 to 100
	<p>Reset VGA Options: Resets all settings in the VGA Options menu to the factory preset values.</p>	Yes No

ADJUSTING THE LCD DISPLAY

Item	Function	Range
Advanced Options	<p>Key Lock Settings: Enables or disables some or all control panel buttons.</p> <ul style="list-style-type: none"> • Unlock: Unlock all control panel buttons. • Lock All but Power: Lock all control panel buttons except for the Power button. • Lock All except PWR & VOL: Lock all control panel buttons except for the Power and Volume control buttons. • Lock All: Lock all control panel buttons. <p>Note: To unlock all the buttons, you can also press the  button on the control panel for 5 seconds or the  button on the remote control for 5 seconds.</p>	Unlock Lock All but Power Lock All except PWR & VOL Lock All
	<p>IR Lock Settings: Enables or disables some or all remote control buttons.</p> <ul style="list-style-type: none"> • Unlock: Unlock all remote control buttons. • Lock All but Power: Lock all remote control buttons except for the Power button. • Lock All except PWR & VOL: Lock all remote control buttons except for the Power and Volume control buttons. • Lock All: Lock all remote control buttons. <p>Note: To unlock all the buttons, you can also press the  button on the control panel for 5 seconds or the  button on the remote control for 5 seconds.</p>	Unlock Lock All but Power Lock All except PWR & VOL Lock All
	LED Indicator: Sets the display LED indicator on or off.	Off On
	Logo: Chooses to enable or disable the picture of Logo when you turn on your LCD display.	Off On
	Blue Screen: Enables or disables the blue screen feature. If the setting is set to On , it displays a blue screen when no signal is available.	Off On
	Thermal Protect: Enables or disables displaying a temperature warning when the internal temperature is high.	Off On

ADJUSTING THE LCD DISPLAY

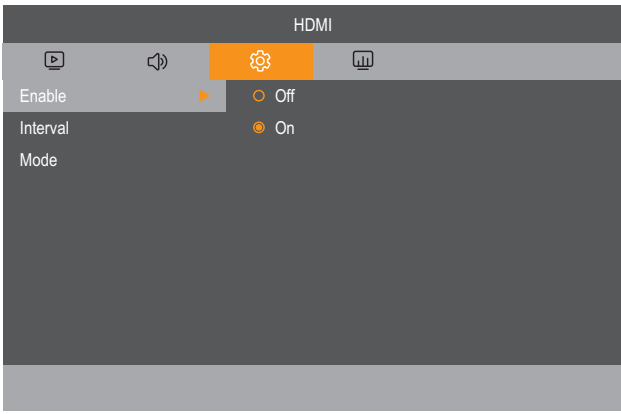
Item	Function	Range
Advanced Options	<p>DVI: Selects the mode to display the DVI signal according to its signal format depending on its source device.</p> <ul style="list-style-type: none"> DVI-PC: Select this option when the source device is a PC. DVI-HDMI: Select this option when there is Audio Signal and the source is a video device. <p>Note:</p> <ul style="list-style-type: none"> DVI settings can be configured only if the source is DVI. DVI-PC supports FHD 1080 and DVI-HDMI supports 4K@60Hz. 	DVI-PC DVI-HDMI
	<p>Anti-Burn-in™: Selects the time interval for the display to slightly expand the image size and shift the position of pixels in four directions (up, down, left, or right).</p> <p>Note: Anti-Burn-in™ will disable the H.Position and V.Position functions in the VGA Options menu.</p>	Enable Interval Mode
		
	<p>Enable: Enables or disables Anti-Burn-in™ function.</p>	Off On
	<p>Interval: If the Anti-Burn-in™ is set to On, selects the interval time (hour) between activating the function.</p>	4 5 6 8
<p>Mode: Sets the Anti-Burn-in™ mode to “A” (executes fast), “B” (slower but more precise than mode “A”), or C (slowest but the most precise mode).</p>	A B C	
	Signal Information: Displays input signal information.	N/A
Monitor Information	View the information about your LCD display, including model name, firmware version, LAN FW version, and internal temperature.	N/A
Factory Reset	Resets all settings in the Setting menu to the factory preset values.	Yes No

ADJUSTING THE LCD DISPLAY



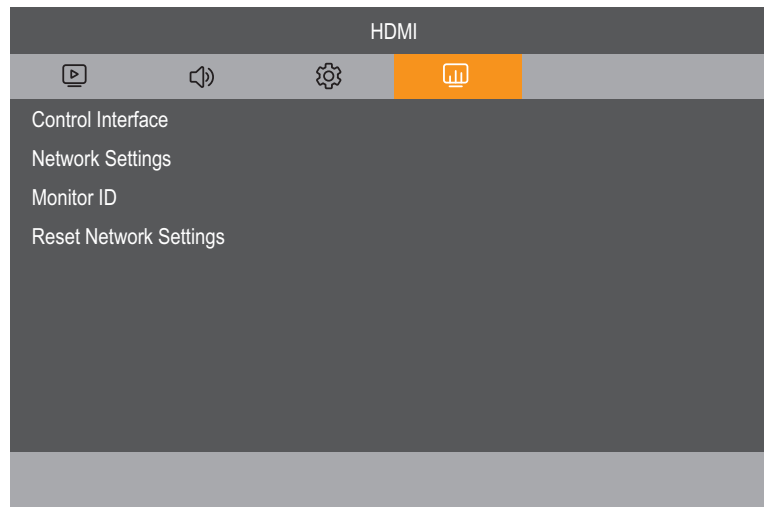

4.4 Network



Item	Function	Range
Control Interface	Selects the network control port. Note: If LAN is selected then RS232 is disabled and vice versa.	LAN RS232
Network Settings Note: Network settings can be configured only if the Control Interface is set to LAN .	<p>Network Config: Configures network settings automatically (DHCP IP) or manually (Static IP).</p> <p>The screenshot shows the Network Config menu with the following options: Network Config (Static IP), IP Address: 192 . 168 . 0 . 10, Subnet Mask: 255 . 255 . 255 . 0, Default Gateway: 0 . 0 . 0 . 0, DNS Primary: 0 . 0 . 0 . 0, DNS Secondary: 0 . 0 . 0 . 0, and MAC Address: F4:ED:5F:E7:0F:71. A Save button is visible at the bottom.</p>	
	DHCP IP: Receives network access parameters automatically from the server. Note: Make sure the display is connected to the network.	DHCP IP Static IP
	Static IP: Enters the network parameters manually. Note: Make sure the display is connected to the network.	
Monitor ID	Selects Monitor ID: Adjusts the ID number for controlling the display via the RS232C connection. Each display must have a unique ID number when multiple sets of this display are connected.	1 to 255
Reset Network Settings	Resets all settings in the Network Settings menu to the factory preset values. Note: Reset Network Settings is available only if the Control Interface is set to LAN .	Yes No

CHAPTER 5: APPENDIX

5.1 Warning Messages

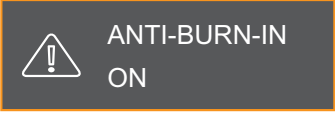
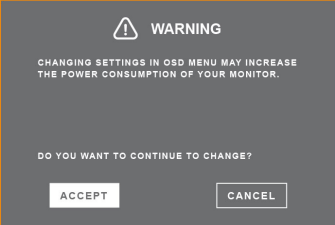
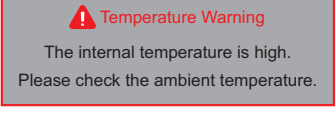
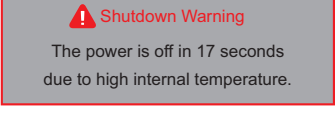
Warning Messages	Cause	Solution
N/A	The resolution or the refresh rate of the graphics card of the computer is set too high.	<ul style="list-style-type: none"> Change the resolution or the refresh rate of the graphics card.
 	The LCD display cannot detect the input source signal and enters the Standby mode.	<ul style="list-style-type: none"> Check if the input source is turned ON. Check if the signal cable is properly connected. Check if any pin inside the cable connector is twisted or broken.
N/A	The operation using the control panel buttons has been locked by the user.	<ul style="list-style-type: none"> Disable the key lock function in Setting > Advanced Options > Key Lock Settings menu or press the  button for 5 seconds. Refer to 30.
N/A	The operation using the remote control buttons has been locked by the user.	<ul style="list-style-type: none"> Disable the IR lock function in Setting > Advanced Options > IR Lock Settings menu or press the  button for 5 seconds. Refer to 30.
	The Anti-Burn-in™ function has been enabled by the user.	<ul style="list-style-type: none"> Disable the Anti-Burn-in™ function. Refer to pages 30 and 31.
	This warning message box will only show when the menu feature setting is changed for the first time.	<ul style="list-style-type: none"> Select ACCEPT to continue the setting changes, or select CANCEL to disable the setting changes.
 	<p>A temperature warning message will appear on the screen when the temperature reaches 55°C (131°F). The device will shut down automatically when the internal temperature reaches 60°C (140°F).</p>	<ul style="list-style-type: none"> Make sure the ventilation slots of the LCD display are not obstructed. Make sure the room temperature is between 0°C to 40°C (32°F to 104°F).

APPENDIX

5.2 Supported Resolutions

No.	Mode	Resolution	Horizontal Pixel (KHz)	Vertical Pixel (Hz)
1	IBM Text	720 x 400 (70)	31.46	70.08
2	IBM G	640 x 350 (70)	31.46	70.08
3	IBM G	640 x 400 (70)	31.46	70.08
4	VESA	640 x 480 (60)	31.46	59.94
5	NEW	640 x 480 (70)	36.05	70.00
6	VESA	640 x 480 (72)	37.86	72.81
7	VESA	640 x 480 (75)	37.50	75.00
8	VESA	800 x 600 (60)	37.87	60.31
9	NEW	800 x 600 (70)	46.61	69.99
10	VESA	800 x 600 (72)	48.07	72.18
11	VESA	800 x 600 (75)	46.87	75.00
12	VESA	1024 x 768 (60)	48.36	60.00
13	VESA	1024 x 768 (75)	60.02	75.02
14	VESA RB	1280 x 768 (60)	47.39	59.99
15	VESA	1280 x 768(60)	47.77	59.87
16	VESA	1280 x 768 (75)	60.28	74.89
17	VESA	1280 x 768 (85)	68.63	84.83
18	VESA	1280 x 1024 (60)	63.98	60.02
19	VG828	1280 x 1024 (67)	70.66	66.47
20	NEC A	1280 x 1024 (70)	74.88	69.85
21	NEW	1280 x 1024 (72)	76.75	72.00
22	VESA	1280 x 1024 (75)	79.97	75.02
23	EIA	1280 x 720p (50)	37.50	50.00
24	EIA	1280 x 720p (60)	44.95	59.94
25	EIA	1920 x 1080i (50)	28.12	50.00
26	EIA	1920 x 1080i (60)	33.71	59.94
27	EIA	1920 x 1080p (50)	56.25	50.00
28	EIA	1920 x 1080p (60)	67.43	59.94
29	VESA	1920 x 1440 (60)	90.00	60.00
30	CEA	3840 x 2160 (50)	112.50	60.00
31	CEA	3840 x 2160 (60)	135.00	60.00

Default timing (preset timing):

- Tolerance range is \geq Hor. \pm 1 kHz and Ver. \pm 1Hz. Input sync is in the tolerance range to regard the same timing mode.
- Any timing that is within the supported range should display normally.
- If the timing is outside the supported range, the display will show a warning message (“Out of range”).
- The screen image inside the supported timing will display clearly, without flickering noise, and discolouration.
- If the VGA source is selected, the display does auto adjustment the first time the source is detected, except for 640 x 350, 720 x 350, 640 x 400, and 720 x 400 resolutions.
- The auto adjustment function follows the VESA and CEA/EIA standard timing parameters to center the VGA source image on the screen.

APPENDIX

- New timing (not standard) must follow the standard timing to display the screen image properly.

User timing (new timing):

- If the timing does not match with the standard timing listed in the table above, then user can store more than 20 user preset timings to the EEPROM in FIFO configuration.

Source/timing changing time

- Timing change for image stability under 1.0 seconds (without panel blanking).
- Power ON picture stability/with AG Neovo logo \leq 8.0 seconds.
- Input source change blanking time (between VGA and DIGITAL source): \leq 3.0 seconds.
- Input source change blanking time (between PC and VIDEO): \leq 3.0 seconds.
- PC: VGA & DVI, VIDEO: HDMI.

SDI Timing

SDI Timing					Resolution
SMPTE-259M	SD-SDI	YCbCr 422 10bit	1440 x 487	Int	NTSC
SMPTE-259M	SD-SDI	YCbCr 422 10bit	1440 x 576	Int	PAL
SMPTE-274M	HD-SDI	YCbCr 422 10bit	1920 x 1080	Int	1080 @60i
SMPTE-274M	HD-SDI	YCbCr 422 10bit	1920 x 1080	Int	1080 @59.94i
SMPTE-274M	HD-SDI	YCbCr 422 10bit	1920 x 1080	Int	1080 @50i
SMPTE-274M	HD-SDI	YCbCr 422 10bit	1920 x 1080	Int	1080 @30psf
SMPTE-274M	HD-SDI	YCbCr 422 10bit	1920 x 1080	Int	1080 @29.97psf
SMPTE-274M	HD-SDI	YCbCr 422 10bit	1920 x 1080	Int	1080 @25psf
SMPTE-274M	HD-SDI	YCbCr 422 10bit	1920 x 1080	Int	1080 @24psf
SMPTE-274M	HD-SDI	YCbCr 422 10bit	1920 x 1080	Int	1080 @23.98psf
SMPTE-296M	HD-SDI	YCbCr 422 10bit	1280 x 720	Prog	720 @60p
SMPTE-296M	HD-SDI	YCbCr 422 10bit	1280 x 720	Prog	720 @59.94p
SMPTE-296M	HD-SDI	YCbCr 422 10bit	1280 x 720	Prog	720 @30p
SMPTE-296M	HD-SDI	YCbCr 422 10bit	1280 x 720	Prog	720 @29.97p
SMPTE-296M	HD-SDI	YCbCr 422 10bit	1280 x 720	Prog	720 @25p
SMPTE-296M	HD-SDI	YCbCr 422 10bit	1280 x 720	Prog	720 @24p
SMPTE-296M	HD-SDI	YCbCr 422 10bit	1280 x 720	Prog	720 @23.98p
SMPTE-296M	HD-SDI	YCbCr 422 10bit	1280 x 720	Prog	720 @50p
SMPTE-425M	3G-SDI	YCbCr 422 10bit	1920 x 1080	Prog	3G-A 60p
SMPTE-425M	3G-SDI	YCbCr 422 10bit	1920 x 1080	Prog	3G-A 59p
SMPTE-425M	3G-SDI	YCbCr 422 10bit	1920 x 1080	Prog	3G-A 50p
SMPTE-274M	HD-SDI	YCbCr 422 10bit	1920 x 1080	Prog	1080 @29.97p
SMPTE-274M	HD-SDI	YCbCr 422 10bit	1920 x 1080	Prog	1080 @30p
SMPTE-274M	HD-SDI	YCbCr 422 10bit	1920 x 1080	Prog	1080 @23.98p
SMPTE-274M	HD-SDI	YCbCr 422 10bit	1920 x 1080	Prog	1080 @24p
SMPTE-274M	HD-SDI	YCbCr 422 10bit	1920 x 1080	Prog	1080 @25p

APPENDIX

General guidelines:

- The PC text quality is optimum in HD 1080 mode (1920 x 1080, 60Hz).
- Your PC display screen might appear different depending on the manufacturer (and your particular version of Windows).
- Check your PC instruction book for information about connecting your PC to a display.
- If a vertical and horizontal frequency-select mode exists, select 60Hz (vertical) and 31.5KHz (horizontal). In some cases, abnormal signals (such as stripes) might appear on the screen when the PC power is turned off (or if the PC is disconnected). If so, press the **SOURCE** button to enter the video mode. Also, make sure that the PC is connected.
- When horizontal synchronous signals seem irregular in RGB mode, check PC power saving mode or cable connections.
- The display settings table complies to the IBM/VESA standards, and based on the analog input.
- The DVI support mode is regarded as same to the PC support mode.
- The best timing for the vertical frequency to each mode is 60Hz.

5.3 Cleaning

Caution When Using the Display

- Do not bring your hands, face or objects close to the ventilation holes of the display. The top of the display is usually very hot due to the high temperature of exhaust air being released through the ventilation holes. Burns or personal injuries may occur if any body parts are brought too close. Placing any object near the top of the display could also result in heat related damage to the object as well as the display itself.
- Be sure to disconnect all cables before moving the display. Moving the display with its cables attached may damage the cables and thus cause fire or electric shock.
- Disconnect the power plug from the wall outlet as a safety precaution before carrying out any type of cleaning or maintenance procedure.

Front Panel Cleaning Instructions

- The front of the display has been specially treated. Wipe the surface gently using only a cleaning cloth or a soft, lint-free cloth.
- If the surface becomes dirty, soak a soft, lint-free cloth in a mild detergent solution. Wring the cloth to remove excess liquid. Wipe the surface of the display to remove dirt. Then use a dry cloth of the same type to dry.
- Do not scratch or hit the surface of the panel with fingers or hard objects of any kind.
- Do not use volatile substances such as insect sprays, solvents and thinners.

Cabinet Cleaning Instructions

- If the cabinet becomes dirty, wipe the cabinet with a soft, dry cloth.
- If the cabinet is extremely dirty, soak a lint-free cloth in a mild detergent solution. Wring the cloth to remove as much moisture as possible. Wipe the cabinet. Use another dry cloth to wipe over until the surface is dry.
- Do not allow any water or detergent to come into contact with the surface of the display. If water or moisture gets inside the unit, operating problems, electrical and shock hazards may result.
- Do not scratch or hit the cabinet with fingers or hard objects of any kind.
- Do not use volatile substances such as insect sprays, solvents and thinners on the cabinet.
- Do not place anything made from rubber or PVC near the cabinet for any extended periods of time.

APPENDIX

5.4 Troubleshooting

Symptom	Possible Cause	Remedy
No picture is displayed	<ul style="list-style-type: none"> The power cord has been disconnected. The main power switch on the back of the display is not switched on. The selected input has no connection. The display is in standby mode. 	<ol style="list-style-type: none"> 1 Plug in the power cord. 2 Make sure the power switch is switched on. 3 Connect a signal connection to the display.
Interference displayed on the display or audible noise is heard	Caused by surrounding electrical appliances or fluorescent lights.	Move the display to another location to see if the interference is reduced.
Colour is abnormal	The signal cable is not connected properly.	Make sure that the signal cable is attached firmly to the back of the display.
Picture is distorted with abnormal patterns	<ul style="list-style-type: none"> The signal cable is not connected properly. The input signal is beyond the capabilities of the display. 	<ul style="list-style-type: none"> Make sure that the signal cable is attached firmly. Check the video signal source to see if it is beyond the range of the display. Please verify its specifications with this display's specification section.
Display image doesn't fill up the full size of the screen	The picture format is not set correctly.	Press the 16:9 button and select a suitable picture format.
Can hear sound, but no picture	Improperly connected source signal cable.	Make sure that both video inputs and sound inputs are correctly connected.
Can see picture but no sound is heard	<ul style="list-style-type: none"> Improperly connected source signal cable. Volume is turned all the way down. MUTE function is turned on. No external speaker connected. 	<ul style="list-style-type: none"> Make sure that both video and sound inputs are correctly connected. Press the VOL^+ or VOL^- button to hear the sound. Switch the MUTE function off by using the  button. Connect the external speakers and adjust the volume to a suitable level.
Some picture elements do not light up	Some pixels of the display may not turn on.	This display is manufactured using an extremely high level of precision technology: however, sometimes some pixels of the display may not display. This is not a malfunction.
After-Images can still be seen on the display after the display is powered off. (Examples of still pictures include logos, video games, computer images, and images displayed in 4:3 normal mode)	A still picture is displayed for an over extended period of time.	Do not allow a still image to be displayed for an extended period of time as this can cause a permanent after-image to remain on the display.

CHAPTER 6: SPECIFICATIONS

6.1 Display Specifications

		HMQ-4301	HMQ-5501	HMQ-6501
Panel	Panel Type	LED-Backlit TFT LCD (IPS Technology)	LED-Backlit TFT LCD (IPS Technology)	LED-Backlit TFT LCD (IPS Technology)
	Panel Size	43"	54.6"	64.5"
	Max. Resolution	UHD 3840 x 2160	UHD 3840 x 2160	UHD 3840 x 2160
	Pixel Pitch	0.245 mm	0.315 mm	0.372 mm
	Brightness	350 cd/m ²	350 cd/m ²	400 cd/m ²
	Contrast Ratio	1200:1	1200:1	1200:1
	Viewing Angle (H/V)	178°/178°	178°/178°	178°/178°
	Display Colour	1.07B	1.07B	1.07B
	Response Time	5 ms	5 ms	5 ms
	Surface Treatment	Anti-Glare Treatment (Haze 1%), 3H Hard Coating	Anti-Glare Treatment (Haze 1%), 3H Hard Coating	Anti-Glare Treatment (Haze 1%), 3H Hard Coating
Frequency (H/V)	Frequency (H)	15 KHz-135 KHz	15 KHz-135 KHz	15 KHz-135 KHz
	Frequency (V)	24 Hz-86 Hz	24 Hz-86 Hz	24 Hz-86 Hz
Signal Input	SDI	BNC x 1	BNC x 1	BNC x 1
	HDMI	2.0 x 1	2.0 x 1	2.0 x 1
	DVI	24-Pin DVI-D	24-Pin DVI-D	24-Pin DVI-D
	VGA	15-Pin D-Sub x 1	15-Pin D-Sub x 1	15-Pin D-Sub x 1
	Composite	BNC x 1	BNC x 1	BNC x 1
Signal Output	Composite	BNC x 1	BNC x 1	BNC x 1
	SDI	BNC x 1	BNC x 1	BNC x 1
External Control	RS232 In	9-Pin D-Sub	9-Pin D-Sub	9-Pin D-Sub
	LAN	RJ45 x 1	RJ45 x 1	RJ45 x 1
Other Connectivity	USB	2.0 x 1 (Service Port)	2.0 x 1 (Service Port)	2.0 x 1 (Service Port)
Audio	Audio In	Stereo Audio Jack (3.5 mm)	Stereo Audio Jack (3.5 mm)	Stereo Audio Jack (3.5 mm)
	Audio Out	Stereo Audio Jack (3.5 mm), S/PDIF	Stereo Audio Jack (3.5 mm), S/PDIF	Stereo Audio Jack (3.5 mm), S/PDIF
	Internal Speakers	5W x 2	5W x 2	10W x 2
SDI Format	3G-SDI (SMPTE 424M)	1080p @50/60fps	1080p @50/60fps	1080p @50/60fps
	HD-SDI (SMPTE 292M)	720p @25/30/50/60fps, 1080p @24/25/30/50/60fps 1080i @50/60fps	720p @25/30/50/60fps, 1080p @24/25/30/50/60fps 1080i @50/60fps	720p @25/30/50/60fps, 1080p @24/25/30/50/60fps 1080i @50/60fps
	SD-SDI (SMPTE 259M)	480i @60fps, 576i @50fps	480i @60fps, 576i @50fps	480i @60fps, 576i @50fps
Power	Power Requirements	AC 100-240V, 50/60 Hz	AC 100-240V, 50/60 Hz	AC 100-240V, 50/60 Hz
	On Mode	75W	99W	123W
	Standby Mode	< 0.5W	< 0.5W	< 0.5W
	Off Mode	< 0.3W	< 0.3W	< 0.3W
	Power Supply	Internal	Internal	Internal
Operating Conditions	Temperature	0°C-40°C (32°F-104°F)	0°C-40°C (32°F-104°F)	0°C-40°C (32°F-104°F)
	Humidity	20%-85% (non-condensing)	20%-85% (non-condensing)	20%-85% (non-condensing)
Storage Conditions	Temperature	-10°C-60°C (-4°F-140°F)	-10°C-60°C (-4°F-140°F)	-10°C-60°C (-4°F-140°F)
	Humidity	10%-95% (non-condensing)	10%-95% (non-condensing)	10%-95% (non-condensing)
Mounting	VESA FPMPMI	Yes (400 x 200 mm)	Yes (400 x 400 mm)	Yes (600 x 400 mm)
Dimensions	with Bracket (W x H x D)	969.9 x 558.3 x 84.6 mm (38.2" x 22.0" x 3.3")	1243.2 x 714.0 x 69.6 mm (48.9" x 28.1" x 2.7")	1476.7 x 851.7 x 79.8 mm (58.1" x 33.5" x 3.1")
	Packaging (W x H x D)	1070.0 x 663.0 x 153.0 mm (42.1" x 26.1" x 6.0")	1364.0 x 824.0 x 154.0 mm (53.7" x 32.4" x 6.1")	1660.0 x 1045.0 x 220.0 mm (65.4" x 41.1" x 8.7")
Weight	Product w/o Base	9.2 kg (20.3 lb)	15.0 kg (33.1 lb)	26.2 kg (57.8 lb)
	Packaging	11.9 kg (26.2 lb)	18.8 kg (41.5 lb)	36.7 kg (80.9 lb)

Note:

- ◆ All specifications are subject to change without prior notice.

SPECIFICATIONS

6.2 Display Dimensions

HMQ-4301

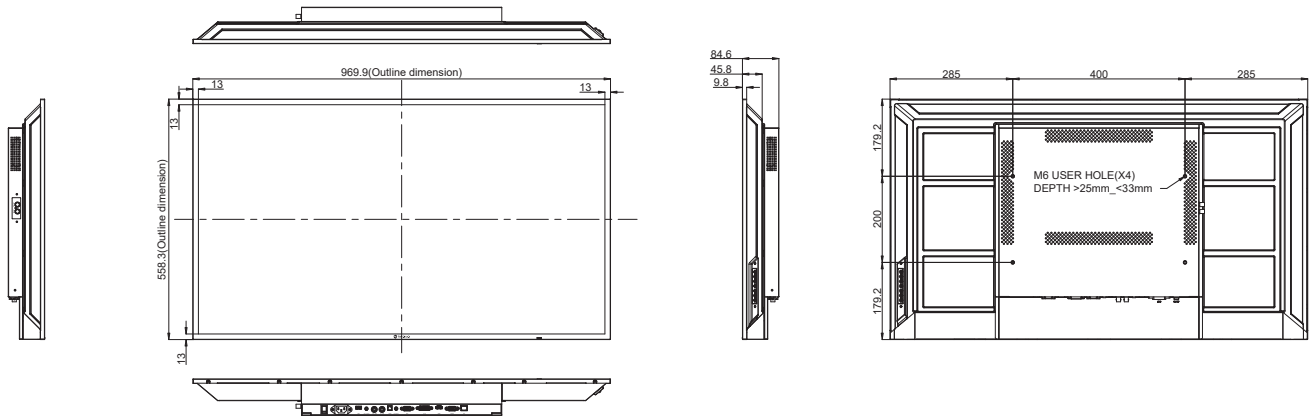

HMQ-5501

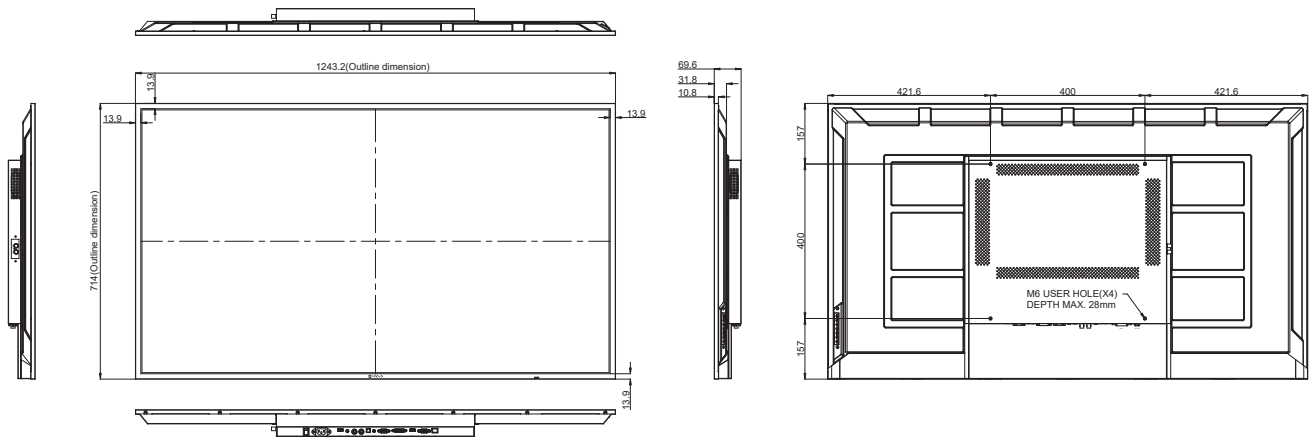

HMQ-6501

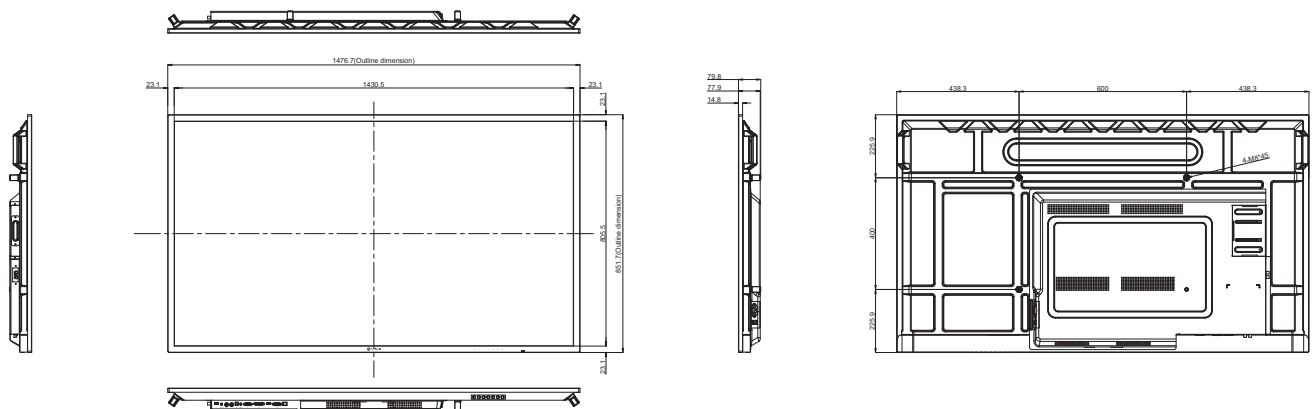

AG Neovo

Company Address: 5F-1, No. 3-1, Park Street, Nangang District, Taipei, 11503, Taiwan.

Copyright © 2022 AG Neovo. All rights reserved.

HMQ-4301/5501/6501 Eprel registration number: 1160157/1160158/1160159

HM4310/HM5510/HM6510_UM_V010