



Network Video Recorder

User's Manual







Foreword

General

This user's manual (hereinafter referred to be "the Manual") introduces the installation, functions and operations of the Network Video Recorder (NVR) devices (hereinafter referred to be "the Device"). Read carefully before using the Device, and keep the manual safe for future reference.

Safety Instructions

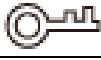
The following signal words might appear in the manual.

Signal Words	Meaning
 DANGER	Indicates a high potential hazard which, if not avoided, will result in death or serious injury.
 WARNING	Indicates a medium or low potential hazard which, if not avoided, could result in slight or moderate injury.
 CAUTION	Indicates a potential risk which, if not avoided, could result in property damage, data loss, reductions in performance, or unpredictable results.
 TIPS	Provides methods to help you solve a problem or save you time.
 NOTE	Provides additional information as a supplement to the text.

Revision History

Version	Revision Content	Release Time
V2.3.1	Added 8 models.	February 2023
V2.3.0	<ul style="list-style-type: none"> Added NVR608H-32-XI/NVR608H-64-XI/NVR608H-128-XI/NVR608RH-32-XI/NVR608RH-64-XI/NVR608RH-128-XI. Added smart tracking and sub screen mirroring. 	August 2022
V2.2.0	Added AI SSA and Quick Pick.	June 2022
V2.1.0	Updated cluster service.	April 2022
V2.0.0	<ul style="list-style-type: none"> Added intelligent diagnosis. Added report query. Added resetting password through DMSS app. Added LLDP. Updated several figures of the local interface. 	March 2022

Version	Revision Content	Release Time
V1.4.0	Added NVR11HS-W-S2-CE and NVR11HS-W-S2-FCC.	January 2022
V1.3.0	<ul style="list-style-type: none"> Added some models. Updated the web login page. Added privacy masking. Added AI codec. 	November 2021
V1.2.0	Added NVR44-4KS2/I, NVR44-16P-4KS2/I, NVR48-4KS2/I, and NVR48-16P-4KS2/I.	June 2021
V1.1.0	Combined AI and non-AI models and deleted discontinued models.	May 2021
V1.0.10	Added several models.	April 2021
V1.0.9	Added 6 models.	February 2021
V1.0.8	Added 5 models.	January 2021
V1.0.7	<ul style="list-style-type: none"> Added 2 models. Added "5.11.7 Cellular Network". 	August 2020
V1.0.6	<ul style="list-style-type: none"> Added picture search, picture search playback, disk health monitoring, and exporting and importing face database. Updated AI search, human detection, configuration of face recognition, and display settings. 	May 2020
V1.0.5	Added split tracking, main-sub tracking, analytics list, configuring video quality analytics, iSCSI, and cluster service.	May 2020
V1.0.4	<ul style="list-style-type: none"> Added 16 models. Added PoE status, switch, and display. 	April 2020
V1.0.3	<ul style="list-style-type: none"> New GUI baseline, replaces all interfaces. Added AI functions. 	July 2019
V1.0.2	Updated the description of rear panel.	May 2019
V1.0.1	<ul style="list-style-type: none"> Added NVR 5216-16P-I and NVR5216-8P-I. Updated relevant info. Updated icons on the rear panel. Added video metadata function and non-motor vehicle detection function. 	September 2018

Privacy Protection Notice

As the device user or data controller, you might collect the personal data of others such as their face, fingerprints, and license plate number. You need to be in compliance with your local privacy protection laws and regulations to protect the legitimate rights and interests of other people by implementing measures which include but are not limited to: Providing clear and visible identification to inform people of the existence of the surveillance area and provide required contact information.

About the Manual

- The manual is for reference only. If there is inconsistency between the manual and the actual product,
- We are not liable for any loss caused by the operations that do not comply with the manual.
- The manual would be updated according to the latest laws and regulations of related regions. For detailed information, see the paper manual, CD-ROM, QR code or our official website. If there is inconsistency between paper manual and the electronic version, the electronic version shall prevail.
- All the designs and software are subject to change without prior written notice. The product updates might cause some differences between the actual product and the manual. Please contact the customer service for the latest program and supplementary documentation.
- There still might be deviation in technical data, functions and operations description, or errors in print. If there is any doubt or dispute, please see our final explanation.
- Upgrade the reader software or try other mainstream reader software if the manual (in PDF format) cannot be opened.
- All trademarks, registered trademarks and the company names in the manual are the properties of their respective owners.
- Please visit our website, contact the supplier or customer service if there is any problem occurred when using the device.
- If there is any uncertainty or controversy, please see our final explanation.

Important Safeguards and Warnings

This section introduces content covering the proper handling of the Device, hazard prevention, and prevention of property damage. Read carefully before using the Device, and comply with the guidelines when using it.

Transportation Requirements



Transport the Device under allowed humidity and temperature conditions.

Storage Requirements



Store the Device under allowed humidity and temperature conditions.

Operation Requirements



- Do not place the Device in a place exposed to sunlight or near heat sources.
- Keep the Device away from dampness, dust, and soot.
- Install the Device on a stable surface to prevent it from falling.
- Do not drop or splash liquid onto the Device, and make sure that there is no object filled with liquid on the Device to prevent liquid from flowing into it.
- Put the Device in a well-ventilated place, and do not block its ventilation.
- Operate the Device within the rated range of power input and output.
- Do not disassemble the Device.
- Use the Device under allowed humidity and temperature conditions.

Installation Requirements



- Do not connect the power adapter to the device while the adapter is powered on.
- Strictly comply with the local electric safety code and standards. Make sure the ambient voltage is stable and meets the power supply requirements of the device.
- Do not expose the battery to environments with extremely low air pressure, or extremely high or low temperatures. Also, it is strictly prohibited to throw the battery into a fire or furnace, and to cut or put mechanical pressure on the battery. This is to avoid the risk of fire and explosion.
- Use the standard power adapter or cabinet power supply. We will assume no responsibility for any injuries or damages caused by the use of a nonstandard power adapter.



- Do not place the Device in a place exposed to sunlight or near heat sources.
- Keep the Device away from dampness, dust, and soot.
- Put the Device in a well-ventilated place, and do not block its ventilation.
- Install the Device on a stable surface to prevent it from falling.

- The power supply must conform to the requirements of ES1 in IEC 62368-1 standard and be no higher than PS2. Please note that the power supply requirements are subject to the device label.
- The device is a class I electrical appliance. Make sure that the power supply of the Device is connected to a power socket with protective earthing.
- Use power cords that conform to your local requirements, and are rated specifications.
- Before connecting the power supply, make sure the input voltage matches the power requirements of the Device.
- When installing the Device, make sure that the power plug and appliance coupler can be easily reached to cut off power.
- Install the Device near a power socket for emergency disconnect.
- It is prohibited for non-professionals and unauthorized personnel to open the Device casing.

Table of Contents

Foreword	I
Important Safeguards and Warnings.....	IV
1 Introduction	1
1.1 Overview	1
1.2 Features.....	1
2 Front Panel and Rear Panel	4
2.1 Front Panel.....	4
2.1.1 NVR41-4KS2/NVR41-P-4KS2/NVR41-8P-4KS2/NVR41-4KS2/L/NVR41-P-4KS2/L/NVR41-8P-4KS2/L/NVR21-4KS2/NVR21-P-4KS2/NVR21-8P-4KS2/NVR21-S3/NVR21-P-S3/NVR21-8P-S3 Series	4
2.1.2 NVR11HS-S3H/NVR11HS-P-S3H/NVR11HS-8P-S3H/NVR41HS-4KS2/NVR41HS-P-4KS2/NVR41HS-S-8P-4KS2/NVR41HS-4KS2/L/NVR41HS-P-4KS2/L/NVR41HS-8P-4KS2/L/NVR21HS-4KS2/NVR21HS-P-4KS2/NVR21HS-8P-4KS2/NVR21HS-S3/NVR21HS-P-S3/NVR21HS-8P-S3	6
2.1.3 NVR52-4KS2/NVR52-8P-4KS2/NVR52-16P-4KS2/NVR42-4KS2/NVR42-P-4KS2/NVR42-8P-4KS2/NVR42-16P-4KS2/NVR42-4KS2/L/NVR42-P-4KS2/L/NVR42-8P-4KS2/L/NVR42-16P-4KS2/L/NVR5224-24P-4KS2/NVR54-4KS2/NVR54-16P-4KS2/NVR44-4KS2/NVR44-16P-4KS2/NVR44-4KS2/L/NVR44-16P-4KS2/L/NVR5424-24P-4KS2/NVR58-4KS2/NVR58-16P-4KS2/NVR48-4KS2/NVR48-16P-4KS2/NVR48-4KS2/L/NVR48-16P-4KS2/L/NVR22-4KS2/NVR22-P-4KS2/NVR22-8P-4KS2/NVR52-8P-4KS2E/NVR52-16P-4KS2E/NVR54-16P-4KS2E/NVR58-16P-4KS2E	7
2.1.4 NVR21-W-4KS2 Series.....	8
2.1.5 NVR21HS-W-4KS2/NVR11HS-W-S2-CE/NVR11HS-W-S2-FCC Series.....	9
2.1.6 NVR21-I/NVR21-I2/NVR21-P-I/NVR21-P-I2/NVR21-8P-I/NVR21-8P-I2 Series.....	10
2.1.7 NVR22-I/NVR22-I2/NVR22-P-I/NVR22-P-I2/NVR22-8P-I/NVR22-8P-I2/NVR22-16P-I/NVR22-16P-I2/NVR52-EI/NVR52-8P-EI/NVR52-16P-EI Series.....	11
2.1.8 NVR21HS-I/NVR21HS-I2/NVR21HS-P-I/NVR21HS-P-I2/NVR21HS-8P-I/NVR21HS-8P-I2/NVR44-4KS2/I/NVR44-16P-4KS2/I Series	13
2.1.9 NVR48-I/NVR58-I/NVR58-I/L Series	13
2.1.10 NVR42-I/NVR44-I/NVR54-I/NVR54-I/L/NVR52-I/NVR52-I/L Series.....	14
2.1.11 NVR48-4KS2/I/NVR48-16P-4KS2/I/NVR54-EI/NVR54-16P-EI/NVR58-EI/NVR58-16P-EI Series	14
2.1.12 NVR608-32-4KS2 Series	15
2.1.13 NVR608-64-4KS2/NVR608-128-4KS2/NVR608H-XI/NVR608RH-XI Series	16
2.1.14 NVR616-4KS2/NVR616-4KS2Advanced 3U AI NVR Series/NVR5064-EI Series	17
2.2 Rear Panel.....	19
2.2.1 NVR21-4KS2/NVR21-P-4KS2/NVR21-8P-4KS2 Series	19

2.2.2	NVR11HS-S3H/NVR11HS-P-S3H/NVR11HS-8P-S3H/NVR21HS-4KS2/NVR21HS-P-4KS2/NVR21HS-8P-4KS2/NVR41HS-4KS2/NVR41HS-P-4KS2/NVR41HS-8P-4KS2/NVR41HS-4KS2/L/NVR41HS-P-4KS2/L/NVR41HS-8P-4KS2/L/NVR21HS-S3/NVR21HS-P-S3/NVR21HS-8P-S3	20
2.2.3	NVR22-4KS2/NVR22-P-4KS2/NVR22-8P-4KS2 Series	22
2.2.4	NVR52-4KS2/NVR52-8P-4KS2/NVR52-16P-4KS2/NVR52-24P-4KS2/NVR52-8P-4KS2E/NVR52-16P-4KS2E/NVR5232-EI/NVR5232-8P-EI/NVR5232-16P-EI1	23
2.2.5	NVR54-4KS2/NVR58-4KS2/NVR54-16P-4KS2/NVR58-16P-4KS2/NVR54-24P-4KS2/NVR58-16P-4KS2E	26
2.2.6	NVR41-4KS2/NVR41-P-4KS2/NVR41-8P-4KS2/NVR41-4KS2/L/NVR41-P-4KS2/L/NVR41-8P-4KS2/L/NVR21-S3/NVR21-P-S3/NVR21-8P-S3	29
2.2.7	NVR42-4KS2/NVR42-P-4KS2/NVR42-8P-4KS2/NVR42-16P-4KS2/NVR42-4KS2/L/NVR42-P-4KS2/L/NVR42-8P-4KS2/L/NVR42-16P-4KS2/L Series	30
2.2.8	NVR44-4KS2/NVR44-16P-4KS2/NVR44-4KS2/L/NVR44-16P-4KS2/L/NVR44-4KS2/I/NVR44-16P-4KS2/I Series	32
2.2.9	NVR48-4KS2/NVR48-16P-4KS2/NVR48-4KS2/L/NVR48-16P-4KS2/L/NVR48-4KS2/I/NVR48-16P-4KS2/I Series	34
2.2.10	NVR21-W-4KS2 Series	37
2.2.11	NVR21HS-W-4KS2Series	38
2.2.12	NVR21-I/NVR21-I2 Series	39
2.2.13	NVR22-I/NVR22-I2 Series	40
2.2.14	NVR21-P-I/NVR21-P-I2 Series	41
2.2.15	NVR22-P-I/NVR22-P-I2 Series	41
2.2.16	NVR21-8P-I/NVR21-8P-I2 Series	43
2.2.17	NVR22-8P-I/NVR22-8P-I2 Series	44
2.2.18	NVR22-16P-I/NVR22-8P-I2 Series	45
2.2.19	NVR21HS-I/NVR21HS-I2 Series	46
2.2.20	NVR21HS-P-I/NVR21HS-P-I2 Series	47
2.2.21	NVR21HS-8P-I/NVR21HS-8P-I2 Series	48
2.2.22	NVR4208-8P-I Series	49
2.2.23	NVR4216-I Series	50
2.2.24	NVR58-I/NVR58-I/L/NVR48-I Series	52
2.2.25	NVR54-I/NVR54-I/L/NVR44-I Series	54
2.2.26	NVR52-16P-I/NVR52-16P-I/L/NVR52-8P-I/NVR52-8P-I/L/NVR42-16P-I Series	56
2.2.27	NVR608-4KS2/NVR608H-XI/NVR608RH-XI Series	58
2.2.28	NVR616-4KS2 Series	60

2.2.29 NVR11HS-W-S2-CE/NVR11HS-W-S2-FCC Series.....	62
2.2.30 NVR54-EI/NVR54-16P-EI/NVR58-EI/NVR58-16P-EI Series.....	63
2.2.31 NVR50-EI Series.....	65
2.3 Alarm Connection.....	66
2.3.1 Alarm Port	66
2.3.2 Alarm Input Port.....	67
2.3.3 Alarm Output Port.....	69
2.3.4 Alarm Relay Specifications.....	70
2.4 Two-way Talk.....	70
2.4.1 Device-end to PC-end	70
2.4.2 PC-end to the Device-end.....	71
3 Device Installation	72
3.1 Device Installation Diagram.....	72
3.2 Checking Unpacked NVR	73
3.3 HDD Installation.....	73
3.3.1	
NVR41-4KS2/NVR41-P-4KS2/NVR41-8P-4KS2/NVR41-4KS2/L/NVR41-P-4KS2/L/NVR41-8P-4KS2/L/NVR21-4KS2/NVR21-P-4KS2/NVR21-8P-4KS2/NVR21-W-4KS2/NVR21-I/NVR21-I2/NVR21-P-I/NVR21-P-I2/NVR21-8P-I/NVR21-8P-I2/NVR21-S3/NVR21-P-S3/NVR21-8P-S3.....	74
3.3.2	
NVR41HS-4KS2/NVR41HS-P-4KS2/NVR41HS-8P-4KS2/NVR41HS-4KS2/L/NVR41HS-P-4KS2/L/NVR41HS-8P-4KS2/L/NVR21HS-4KS2/NVR21HS-P-4KS2/NVR21HS-8P-4KS2/NVR21HS-W-4KS2/NVR11HS-S3H/NVR11HS-P-S3H/NVR11HS-8P-S3H/NVR21HS-I/NVR21HS-I2/NVR21HS-P-I/NVR21HS-P-I2/NVR21HS-8P-I/NVR21HS-8P-I2/NVR21HS-S3/NVR21HS-P-S3/NVR21HS-8P-S3/NVR11HS-W-S2-CE/NVR11HS-W-S2-FCC Series.....	76
3.3.3	
NVR22-8P-S2/NVR42-4KS2/NVR42-P-4KS2/NVR42-8P-4KS2/NVR42-16P-4KS2/NVR42-4KS2/L/NVR42-P-4KS2/L/NVR42-8P-4KS2/L/NVR42-16P-4KS2/L/NVR52-4KS2/NVR52-8P-4KS2/NVR52-16P-4KS2/NVR52-24P-4KS2/NVR22-4KS2/NVR22-P-4KS2/NVR22-8P-4KS2/NVR52-8P-4KS2E/NVR22-I/NVR22-I2/NVR22-P-I/NVR22-P-I2/NVR22-8P-I/NVR22-8P-I2/NVR22-16P-I/NVR22-16P-I2/NVR42-I/NVR42-8P-I/NVR42-16P-I/NVR52-16P-I/NVR52-16P-I/L/NVR52-8P-I/NVR52-8P-I/L Series.....	79
3.3.4	
NVR54-4KS2/NVR54-16P-4KS2/NVR44-4KS2/NVR44-16P-4KS2/NVR44-4KS2/L/NVR44-16P-4KS2/L/NVR54-24P-4KS2/NVR54-16P-4KS2E/NVR58-I/NVR58-I/L/NVR54-I/NVR54-I/L/NVR52-I/NVR52-I/L/NVR42-I/NVR42-8P-I/NVR44-I/NVR48-I/NVR608-32-4KS2/NVR44-4KS2/I/NVR44-16P-4KS2/I/NVR48-4KS2/I/NVR48-16P-4KS2/I Series.....	82
3.3.5 NVR608-64-4KS2/NVR608-128-4KS2/NVR608H-32-XI/NVR608H-64-XI/NVR608H-128-XI Series	86
3.3.6 NVR616-4KS2 Series.....	88
3.4 CD-ROM Installation.....	90
3.5 Connection Sample.....	95
3.5.1	
NVR41-4KS2/NVR41-P-4KS2/NVR41-8P-4KS2/NVR41-4KS2/L/NVR41-P-4KS2/L/NVR41-8P-4KS2	

2/L/NVR21-4KS2/NVR21-P-4KS2/NVR21-8P-4KS2/NVR21-I/NVR21-I2/NVR21-P-I/NVR21-P-I2/NVR21-8P-I/NVR21-8P-I2/NVR21-S3/NVR21-P-S3/NVR21-8P-S3 Series.....	95
3.5.2 NVR21-W-4KS2/NVR21HS-W-4KS2 Series.....	96
3.5.3	
NVR11HS-S3H/NVR11HS-P-S3H/NVR11HS-8P-S3H/NVR41HS-4KS2/NVR41HS-P-4KS2/NVR41HS-8P-4KS2/NVR41HS-4KS2/L/NVR41HS-P-4KS2/L/NVR41HS-8P-4KS2/L/NVR21HS-4KS2/NVR21HS-P-4KS2/NVR21HS-8P-4KS2/NVR21HS-I/NVR21HS-I2/NVR21HS-P-I/NVR21HS-P-I2/NVR21HS-8P-I/NVR21HS-8P-I2/NVR21HS-S3/NVR21HS-P-S3/NVR21HS-8P-S3 Series.....	97
3.5.4	
NVR22-4KS2/NVR22-P-4KS2/NVR22-8P-4KS2/NVR22-I/NVR22-I2/NVR22-P-I/NVR22-P-I2/NVR22-8P-I/NVR22-8P-I2/NVR22-16P-I/NVR22-16P-I2 Series.....	98
3.5.5	
NVR52-4KS2/NVR52-8P-4KS2/NVR52-16P-4KS2/NVR52-24P-4KS2/NVR52-8P-4KS2E/NVR52-16P-4KS2E Series.....	99
3.5.6	
NVR42-4KS2/NVR42-P-4KS2/NVR42-8P-4KS2/NVR42-16P-4KS2/NVR42-4KS2/L/NVR42-P-4KS2/L/NVR42-8P-4KS2/L/NVR42-16P-4KS2/L Series	100
3.5.7	
NVR54-4KS2/NVR54-16P-4KS2/NVR58-4KS2/NVR58-16P-4KS2/NVR54-24P-4KS2/NVR54-16P-4KS2E/NVR58-16P-4KS2E Series.....	101
3.5.8	
NVR44-4KS2/NVR44-16P-4KS2/NVR44-4KS2/L/NVR44-16P-4KS2/L/NVR44-4KS2/I/NVR44-16P-4KS2/I Series	102
3.5.9	
NVR48-4KS2/NVR48-16P-4KS2/NVR48-4KS2/L/NVR48-16P-4KS2/L/NVR48-4KS2/I/NVR48-16P-4KS2/I Series	103
3.5.10 NVR58-I/NVR58-I/L/NVR48-I Series.....	104
3.5.11 NVR54-I/NVR54-I/L/NVR44-I.....	104
3.5.12 NVR52-16P-I/NVR52-16P-I/L/NVR52-8P-I/NVR52-8P-I/L/NVR42-8P-I/NVR42-16P-I Series	105
3.5.13 NVR4216-I Series	105
3.5.14 NVR608-4KS2/NVR608H-XI/NVR608RH-XI Series.....	106
3.5.15 NVR616-4KS2 Series	106
4 Starting the Device	107
5 Local Operations	108
5.1 Initialization	108
5.2 Startup Wizard	110
5.3 Login	115
5.4 Main Menu.....	117
5.5 Quick Operation Bar.....	118
5.6 Live View	120
5.6.1 Live Page	120
5.6.2 Navigation bar	121
5.6.3 Live View Control Bar.....	122

5.6.3.1 Instant Playback.....	123
5.6.3.2 Digital Zoom.....	124
5.6.3.3 Instant Backup.....	124
5.6.3.4 Manual Snapshot.....	124
5.6.3.5 Two-way Talk.....	124
5.6.3.6 Stream Switch.....	125
5.6.3.7 Picture Search.....	125
5.6.3.8 Quick Pick.....	127
5.6.4 Shortcut Menu.....	129
5.6.5 AI Live View Mode.....	131
5.6.6 Split Tracking.....	133
5.6.7 PTZ.....	135
5.6.7.1 PTZ Settings.....	135
5.6.7.2 PTZ Control.....	137
5.6.7.3 Configuring PTZ Functions.....	139
5.6.7.3.1 Configuring Presets.....	139
5.6.7.3.2 Configuring Tours.....	139
5.6.7.3.3 Configuring Patterns.....	140
5.6.7.3.4 Configuring AutoScan.....	141
5.6.7.4 Using PTZ Functions.....	142
5.6.7.4.1 Presets.....	142
5.6.7.4.2 Tours.....	142
5.6.7.4.3 Patterns.....	142
5.6.7.4.4 AutoScan.....	142
5.6.7.4.5 Calling AutoPan.....	143
5.6.7.4.6 Auxiliary Button.....	143
5.6.8 Wireless Pairing.....	143
5.6.9 Sequence.....	144
5.6.10 Fisheye.....	147
5.6.10.1 Fisheye De-warp on Live View Interface.....	147
5.6.10.2 Fisheye De-warp During Playback.....	149
5.6.11 Temperature Monitoring.....	149
5.6.12 Shortcut Menu to Add Camera.....	150
5.6.13 Smart Tracking.....	151
5.7 Camera.....	151
5.7.1 Initializing Remote Devices.....	151
5.7.2 Adding Remote Devices.....	156

5.7.2.1 Adding Cameras from Search	156
5.7.2.2 Adding Cameras Manually	158
5.7.2.3 Importing Cameras	160
5.7.3 Changing IP Address of Remote Device	161
5.7.3.1 Changing IP Address of Connected Remote Device	161
5.7.3.2 Changing IP Address of Unconnected Cameras	161
5.7.4 Configuring Image Settings	162
5.7.5 Configuring Overlay Settings	165
5.7.5.1 Overlay	165
5.7.5.2 Privacy Masking	166
5.7.6 Configuring Encoding Settings	167
5.7.6.1 Configuring Audio and Video Encoding Settings	167
5.7.6.2 Snapshot	170
5.7.7 Modifying Channel Name	171
5.7.8 Checking the PoE Status	172
5.7.9 Updating Remote Devices	173
5.7.10 Viewing Remote Device Information	174
5.7.10.1 Device Status	174
5.7.10.2 Firmware	175
5.8 Recording Management	176
5.8.1 Recording Schedule	176
5.8.1.1 Configuring Video Recording Schedule	176
5.8.1.2 Configuring Snapshot Schedule	181
5.8.1.3 Configuring Recording Mode	182
5.8.2 Search and Playback	183
5.8.2.1 Search Page	183
5.8.2.2 Playback	185
5.8.2.3 Smart Search Playback	187
5.8.2.4 Clipping Videos	188
5.8.2.5 Backing Up	188
5.8.2.6 File List	189
5.8.2.7 Tag Playback	190
5.8.3 Recording Information	191
5.9 AI	191
5.9.1 Overview	191
5.9.2 Smart Plan	192
5.9.3 Face Detection	193

5.9.3.1 Enabling Smart Plan	193
5.9.3.2 Configuring Face Detection	193
5.9.3.3 AI Search (Face Detection)	194
5.9.4 Face & Body Detection	197
5.9.4.1 Enabling Smart Plan	197
5.9.4.2 Configuring Face & Body Detection	197
5.9.4.3 AI Search (Face & Body Detection)	198
5.9.5 Face Recognition	198
5.9.5.1 Enabling Smart Plan	199
5.9.5.2 Creating Face Database	199
5.9.5.2.1 Creating Local Face Databases	199
5.9.5.2.2 Creating Remote Face Databases	200
5.9.5.2.3 Creating the Passerby Database	200
5.9.5.3 Adding Images to Face Database	201
5.9.5.3.1 Adding Face Images One by One	201
5.9.5.3.2 Adding Face Images in Batches	204
5.9.5.4 Configuring Face Recognition	205
5.9.5.4.1 Configuring AI by Recorder	205
5.9.5.4.2 Configuring AI by Camera	206
5.9.5.5 AI Search (Face Recognition)	207
5.9.5.5.1 Search by Attributes	207
5.9.5.5.2 Search by Image	209
5.9.5.5.3 Report Query	210
5.9.6 IVS	211
5.9.6.1 Enabling Smart Plan	211
5.9.6.2 Configuring IVS	211
5.9.6.2.1 Tripwire	211
5.9.6.2.2 Intrusion	214
5.9.6.2.3 Abandoned Object Detection	217
5.9.6.2.4 Fast Moving	220
5.9.6.2.5 Parking	223
5.9.6.2.6 Crowd Gathering	226
5.9.6.2.7 Missing Object Detection	229
5.9.6.2.8 Loitering Detection	232
5.9.6.3 AI Search (IVS)	235
5.9.7 Stereo Analysis	237
5.9.7.1 Enabling Smart Plan	237

5.9.7.2 Configuring Stereo Analysis.....	237
5.9.7.2.1 People Approach Detection.....	237
5.9.7.2.2 Fall Detection.....	238
5.9.7.2.3 Violence Detection.....	239
5.9.7.2.4 People No. Exception Detection.....	240
5.9.7.2.5 People Stay Detection.....	242
5.9.7.3 AI Search (Stereo Analysis).....	243
5.9.8 Video Metadata.....	244
5.9.8.1 Enabling Smart Plan.....	244
5.9.8.2 Configuring Video Metadata.....	244
5.9.8.3 AI Search (Video Metadata).....	246
5.9.8.3.1 Human Detection.....	246
5.9.8.3.2 Motor Vehicle Detection.....	248
5.9.8.3.3 Non-motor Vehicle Detection.....	250
5.9.8.3.4 Report Query.....	251
5.9.9 ANPR.....	252
5.9.9.1 Adding Vehicle Blocklist and Allowlist.....	252
5.9.9.2 Configuring ANPR.....	254
5.9.9.3 AI Search (ANPR).....	255
5.9.10 Crowd Distribution.....	255
5.9.10.1 Enabling Smart Plan.....	255
5.9.10.2 Configuring Crowd Distribution.....	255
5.9.10.3 Report Query.....	256
5.9.11 People Counting.....	257
5.9.11.1 Enabling Smart Plan.....	257
5.9.11.2 Configuring People Counting.....	257
5.9.11.3 Configuring In Area No.....	259
5.9.11.4 Queuing.....	260
5.9.11.5 Report Query.....	260
5.9.12 Heat Map.....	261
5.9.12.1 Enabling Smart Plan.....	261
5.9.12.2 Configuring Heat map.....	262
5.9.12.3 Report Query.....	263
5.9.12.3.1 General.....	263
5.9.12.3.2 Fisheye.....	263
5.9.13 SMD.....	264
5.9.13.1 Enabling Smart Plan.....	264

5.9.13.2 Configuring SMD	264
5.9.13.3 AI Search (SMD)	267
5.9.14 Vehicle Density	267
5.9.14.1 Enabling Smart Plan	267
5.9.14.2 Configuring Vehicle Density	267
5.9.14.3 Report Query	268
5.9.15 Main-sub Tracking	269
5.9.16 Video Quality Analytics	271
5.9.16.1 Configuring Video Quality Analytics	271
5.9.16.2 Analytics List	273
5.9.17 Entries Frequency	273
5.10 Alarm Settings	275
5.10.1 Alarm Information	275
5.10.2 Alarm Status	276
5.10.3 Alarm Input	277
5.10.4 Alarm Output	278
5.10.5 Video Detection	279
5.10.5.1 Motion Detection	279
5.10.5.2 Video Loss	280
5.10.5.3 Video Tampering	281
5.10.5.4 Scene Change	282
5.10.5.5 PIR Alarm	283
5.10.6 Audio Detection	285
5.10.7 Thermal Alarm	285
5.10.8 Exception	286
5.10.9 Disarming	287
5.11 Network	289
5.11.1 TCP/IP	289
5.11.2 Routing Table	292
5.11.3 Port	293
5.11.4 External Wi-Fi	295
5.11.5 Wi-Fi AP	296
5.11.5.1 General Settings	296
5.11.5.2 Advanced Settings	297
5.11.6 3G/4G	299
5.11.7 Cellular Network	300
5.11.8 Repeater	302

5.11.9 PPPoE	305
5.11.10 DDNS.....	305
5.11.11 UPnP.....	307
5.11.11.1 Configuring Router.....	307
5.11.11.2 Configuring UPnP.....	307
5.11.12 Email	308
5.11.13 SNMP	310
5.11.14 Multicast	312
5.11.15 Alarm Center.....	313
5.11.16 Register	314
5.11.17 Switch.....	315
5.11.18 P2P.....	316
5.12 Storage.....	317
5.12.1 Basic.....	317
5.12.2 Disk Manager	318
5.12.3 RAID	319
5.12.3.1 Creating RAID.....	320
5.12.3.2 Viewing RAID Information.....	322
5.12.3.3 Creating Hot Spare Disk.....	322
5.12.4 Disk Group	323
5.12.5 Disk Quota	324
5.12.6 Disk Check.....	325
5.12.6.1 Manual Check.....	325
5.12.6.2 Detection Report	326
5.12.6.3 Disk Health Monitoring.....	328
5.12.7 Record Estimate	329
5.12.7.1 Calculating Recording Time.....	331
5.12.7.2 Calculating HDD Capacity for Storage	331
5.12.8 FTP	332
5.12.9 iSCSI	334
5.13 Account	335
5.13.1 Group	335
5.13.2 User	337
5.13.2.1 Adding User	337
5.13.2.2 Changing Password	339
5.13.3 Resetting Password.....	340
5.13.3.1 Enabling Password Reset	340

5.13.3.2 Resetting Password on Local Interface	340
5.13.4 ONVIF User	345
5.14 Security	346
5.14.1 Security Status.....	346
5.14.2 System Service.....	348
5.14.2.1 Basic Services	348
5.14.2.2 802.1x.....	350
5.14.2.3 HTTPS	351
5.14.3 Attack Defense	352
5.14.3.1 Firewall.....	352
5.14.3.2 Account Lockout.....	353
5.14.3.3 Anti-DoS Attack.....	353
5.14.3.4 Sync Time-Allowlist.....	354
5.14.4 CA Certificate.....	356
5.14.4.1 Device Certificate	356
5.14.4.2 Trusted CA Certificate.....	358
5.14.5 Audio/Video Encryption	359
5.14.6 Security Warning.....	361
5.14.6.1 Security Exception	361
5.14.6.2 Illegal Login.....	361
5.15 System	362
5.15.1 General Settings	362
5.15.1.1 General	362
5.15.1.2 Date and Time.....	364
5.15.1.3 Holiday	365
5.15.2 Serial Port.....	367
5.16 Output and Display	368
5.16.1 Display.....	368
5.16.2 Tour	369
5.16.3 Custom Layout.....	371
5.17 POS	374
5.17.1 Settings	374
5.17.1.1 Privacy Setup.....	375
5.17.1.2 Connection Mode.....	376
5.17.2 Search	377
5.18 Audio.....	377
5.18.1 File Management	378

5.18.2 Audio Play	379
5.18.3 Broadcast	380
5.19 Operation and Maintenance	382
5.19.1 Log	382
5.19.2 System	383
5.19.2.1 System Version	383
5.19.2.2 AI Algorithm Version	384
5.19.2.3 HDD Info	384
5.19.2.4 BPS	385
5.19.2.5 Device Status	385
5.19.3 Network	386
5.19.3.1 Online User	386
5.19.3.2 Network Load	387
5.19.3.3 Network Test	388
5.19.4 Maintenance and Management	389
5.19.4.1 Device Maintenance	389
5.19.4.2 Exporting System Settings	390
5.19.4.3 Restoring Defaults	392
5.19.4.3.1 Restoring Defaults on the Local Interface	392
5.19.4.3.2 Resetting Device through the Reset Button	393
5.19.4.4 System Update	394
5.19.4.4.1 Upgrading File	394
5.19.4.4.2 Online Upgrade	395
5.19.4.4.3 Uboot Upgrading	396
5.19.4.5 Intelligent Diagnosis	396
5.20 USB Device Auto Pop-up	396
5.21 Shutdown	397
6 Web Operation	401
6.1 Network Connection	401
6.2 Web Login	401
6.3 Web Main Menu	402
6.4 Cluster Service	404
6.4.1 Configuring Cluster IP	405
6.4.2 Main Device	405
6.4.3 Sub Device	406
6.4.4 Transferring Videos	407
6.4.5 Configuring Cluster Control	407

6.4.5.1 Cluster Control	407
6.4.5.2 Arbitrage IP	407
6.4.6 Cluster Log	408
7 Glossary	409
8 FAQ	410
Appendix 1 HDD Capacity Calculation	414
Appendix 2 Mouse Operation	415
Appendix 3 Remote Control	416
Appendix 4 Compatible Network Camera List	419
Appendix 5 Cybersecurity Recommendations	425

1 Introduction

1.1 Overview

The NVR is a high performance network video recorder. This product supports local live view, multiple-window display, recorded file local storage, remote control and mouse shortcut menu operation, and remote management and control function.

This product supports center storage, front-end storage and client-end storage. The monitor zone in the front-end can be set in anywhere. Working with other front-end devices such as IPC, NVS, this series product can establish a strong surveillance network through the CMS. In the network system, there is only one network cable from the monitor center to the monitor zone in the whole network. There is no audio/video cable from the monitor center to the monitor zone. The whole project is featured by simple connection, low-cost, low maintenance work.

This NVR can be widely used in areas such as public security, water conservancy, transportation and education.

1.2 Features

AI Functions



AI functions are available on select models and vary with models.

- Face detection. The system can detect the faces are on the video image.
- Face recognition. The system can compare the detected faces with the images in the face database in real time.
- Human body detection. The system activates alarm actions once human body is detected.
- People counting. The system can effectively count the number of people and flow direction.
- Heat map. The system can monitor the active objects in a specific area.
- Automatic number plate recognition (ANPR). The system can effectively monitor the passing vehicles.

Smart Playback



This function is available on select models.

- IVS playback. It can screen out and replay the records meeting the set rules.
- Face detection playback. It can screen out and replay the records with human faces.
- Face recognition playback. It can compare the face information in the video with the information in the database and replay the corresponding records.
- ANPR playback. It can screen out the record with a specific car plate number or all the records with car plate numbers.
- Human body detection playback. It can screen out and replay the records with specific human bodies.

- Smart search. It includes smart functions such as searching by attribute and searching by image to enable users to get target records quickly.

Cloud Upgrade

For the NVR connected to the Internet, it supports application online upgrade.

Real-Time Surveillance

- VGA, HDMI port. Connect to monitor to realize real-time surveillance. Some series support TV/VGA/HDMI output at the same time.
- Shortcut menu for preview.
- Support multiple popular PTZ decoder control protocols. Support preset, tour and pattern.

Playback

- Support independent real-time recording for each channel. At the same time it supports functions such as smart search, forward play, network monitor, record search and download.
- Support various playback modes: slow play, fast play, backward play and frame-by-frame play.
- Support time title overlay so that you can view the event accurate occurred time.
- Support specified zone enlargement.

User Management

Users can be added to user groups for management. Each group has a set of permissions that can be individually edited.

Storage

- With corresponding settings (such as alarm settings and schedule settings), you can back up related audio/video data in the network video recorder.
- You can take records via the web and the record files are saved on the PC in which the client locates.

Alarm

- Respond to external alarm simultaneously (within 200 ms). Based on user's pre-defined relay settings, the system can process the alarm input correctly and sends user screen or voice prompts (supporting pre-recorded audio).
- Support settings of the central alarm server, so that the system can automatically notify users of the alarm information. Alarm input can be derived from various connected peripheral devices.
- Alert you of alarm information via email.

Network Surveillance

- Send audio/video data compressed by IPC or NVS to client-ends through the network, and then the data will be decompressed and displayed.
- Support max 128 connections at the same time.
- Transmit audio/video data by protocols such as HTTP, TCP, UDP, MULTICAST and RTP/RTCP.
- Transmit some alarm data or alarm info by SNMP.
- Support web access in WAN/LAN.

Window Split

Adopt video compression and digital processing to display several windows in one monitor. Support 1/4/8/9/16/25/36 window split in preview and 1/4/9/16 window split in playback.

Record

Support regular record, motion record, alarm record and smart record. Save the recorded files in the HDD, USB device, client-end PC or network storage server and you can search or playback the saved files at the local-end or via the Web/USB devices.

Backup

Support network backup and USB record backup. You can back up the record files in devices such as network storage server, peripheral USB 2.0 device and burner.

Network Management

- Supervise NVR configuration and control power via Ethernet.
- Support web management.

Peripheral Equipment Management

- Support peripheral device control and you can freely set the control protocol and connection port.
- Support transparent data transmission such as RS-232 and RS-485.

Auxiliary

- Support switch between NTSC and PAL.
- Support real-time display of system resources information and running status.
- Support log record.
- Local GUI output. Shortcut menu operation with the mouse.
- IR control function (for some series only). Shortcut menu operation with remote control.
- Support to play the video/audio files from remote IPC or NVS.

2 Front Panel and Rear Panel



The following front panel and rear panel figures are for reference only.

2.1 Front Panel

2.1.1

NVR41-4KS2/NVR41-P-4KS2/NVR41-8P-4KS2/NVR41-4KS2/L/NVR41-P-4KS2/L/NVR41-8P-4KS2/L/NVR21-4KS2/NVR21-P-4KS2/NVR21-8P-4KS2/NVR21-S3/NVR21-P-S3/NVR21-8P-S3 Series



The figure is for reference only.

The

NVR41-4KS2/NVR41-4KS2/L/NVR41-P-4KS2/NVR41-P-4KS2/L/NVR21-4KS2/NVR21-P-4KS2/NVR21-S3/NVR21-P-S3 front panel is shown as below.

Figure 2-1 Front panel

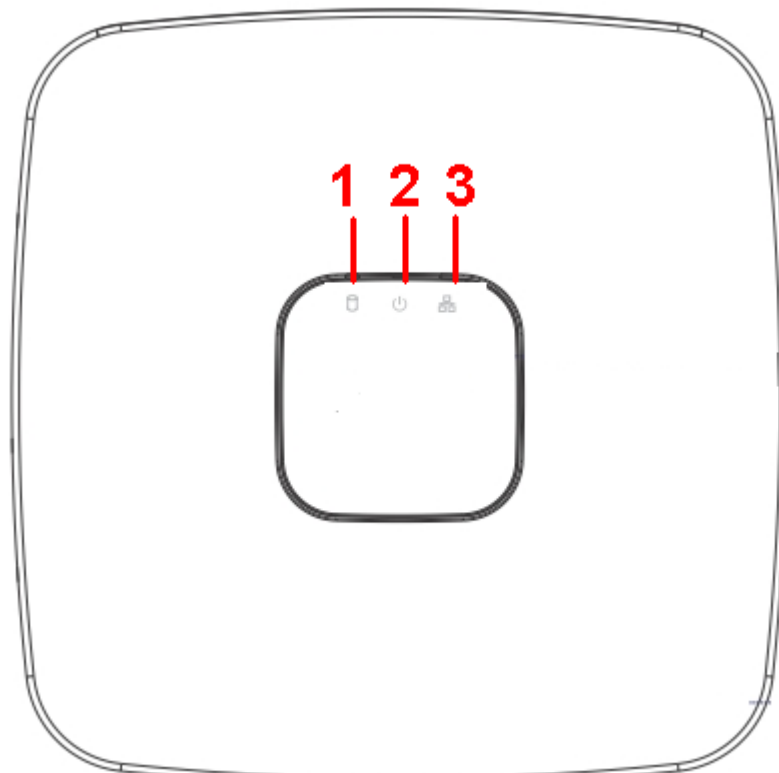

The NVR41-8P-4KS2/NVR41-8P-4KS2/L/NVR21-8P-4KS2/NVR21-8P-S3 front panel is shown as below.

Figure 2-2 Front panel

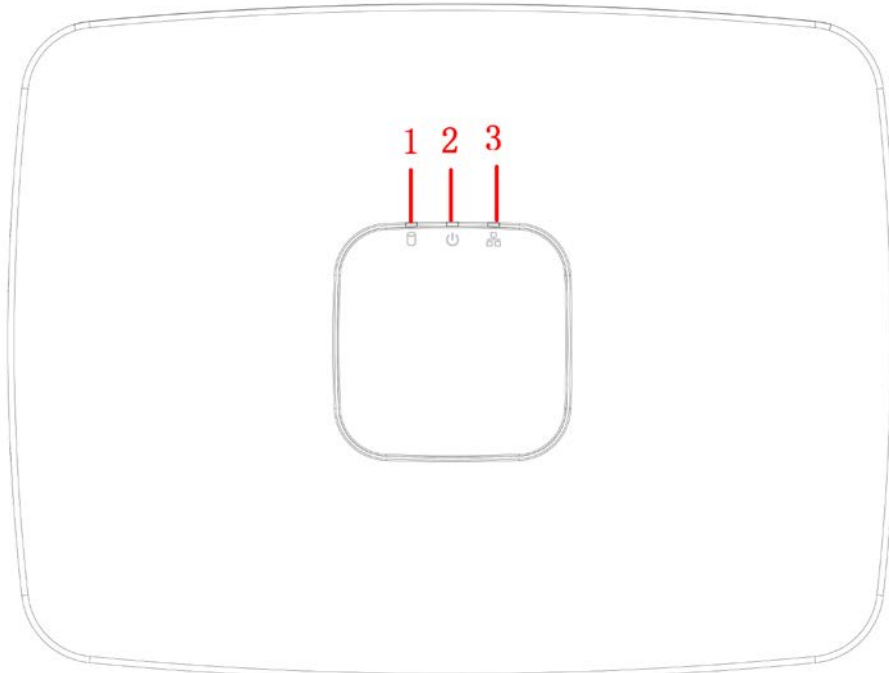

Table 2-1 Icons

No.	Name	Function
1	HDD status indicator light	The red light becomes on when HDD is abnormal.
2	Power indicator light	The red light becomes on when the power connection is normal.
3	Network status indicator light	The red light becomes on when the network connection is abnormal.

2.1.2

**NVR11HS-S3H/NVR11HS-P-S3H/NVR11HS-8P-S3H/NVR41HS-4KS2/
NVR41HS-P-4KS2/NVR41HS-8P-4KS2/NVR41HS-4KS2/L/NVR41HS-P-
-4KS2/L/NVR41HS-8P-4KS2/L/NVR21HS-4KS2/NVR21HS-P-4KS2/NV
R21HS-8P-4KS2/NVR21HS-S3/NVR21HS-P-S3/NVR21HS-8P-S3**



The figure is for reference only.

Figure 2-3 Front panel

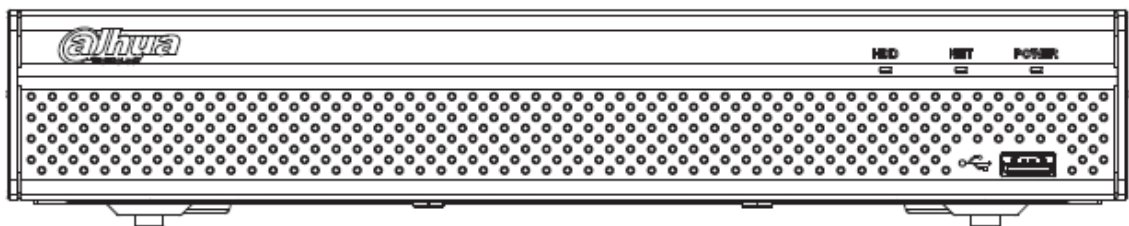



Table 2-2 Icons

Icon	Name	Function
HDD	HDD status indicator light	The blue light is on when the HDD is malfunction.
NET	Network status indicator light	The blue light is on when the network connection is abnormal.
POWER	Power status indicator light	The blue light is on when the power connection is OK.
	USB port	Connect to peripheral USB storage device, mouse and more.

2.1.3

NVR52-4KS2/NVR52-8P-4KS2/NVR52-16P-4KS2/NVR42-4KS2/NVR42-2-P-4KS2/NVR42-8P-4KS2/NVR42-16P-4KS2/NVR42-4KS2/L/NVR42-P-4KS2/L/NVR42-8P-4KS2/L/NVR42-16P-4KS2/L/NVR5224-24P-4KS2/NVR54-4KS2/NVR54-16P-4KS2/NVR44-4KS2/NVR44-16P-4KS2/NVR44-4KS2/L/NVR44-16P-4KS2/L/NVR5424-24P-4KS2/NVR58-4KS2/NVR58-16P-4KS2/NVR48-4KS2/NVR48-16P-4KS2/NVR48-4KS2/L/NVR48-8-16P-4KS2/L/NVR22-4KS2/NVR22-P-4KS2/NVR22-8P-4KS2/NVR52-8P-4KS2E/NVR52-16P-4KS2E/NVR54-16P-4KS2E/NVR58-16P-4KS2E



The figures are for reference only.

The

NVR52-4KS2/NVR52-8P-4KS2/NVR52-16P-4KS2/NVR42-4KS2/NVR42-P-4KS2/NVR42-8P-4KS2/NVR42-16P-4KS2/NVR42-4KS2/L/NVR42-P-4KS2/L/NVR42-8P-4KS2/L/NVR42-16P-4KS2/L/NVR5224-24P-4KS2/NVR22-4KS2/NVR22-P-4KS2/NVR22-8P-4KS2/NVR52-8P-4KS2E/NVR52-16P-4KS2E series front panel is shown as below.

Figure 2-4 Front panel

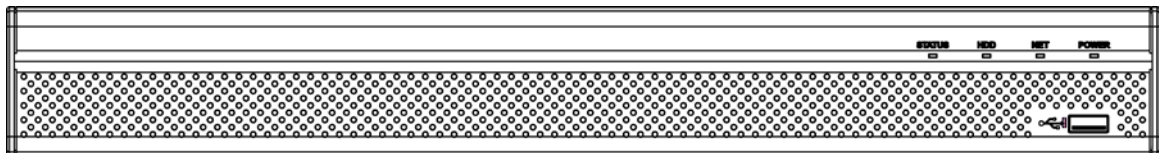

The

NVR54-4KS2/NVR54-16P-4KS2/NVR44-4KS2/NVR44-16P-4KS2/NVR44-4KS2/L/NVR44-16P-4KS2/L/NVR54-24P-4KS2/NVR54-16P-4KS2E series front panel is shown as below.

Figure 2-5 Front panel

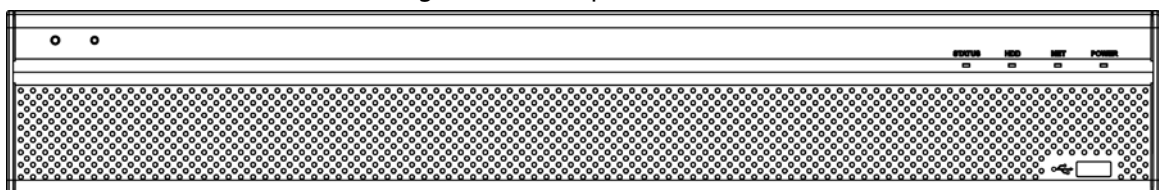

The

NVR58-4KS2/NVR58-16P-4KS2/NVR48-4KS2/NVR48-16P-4KS2/NVR48-4KS2/L/NVR48-16P-4KS2/L/NVR58-16P-4KS2E series front panel is shown as below

Figure 2-6 Front panel

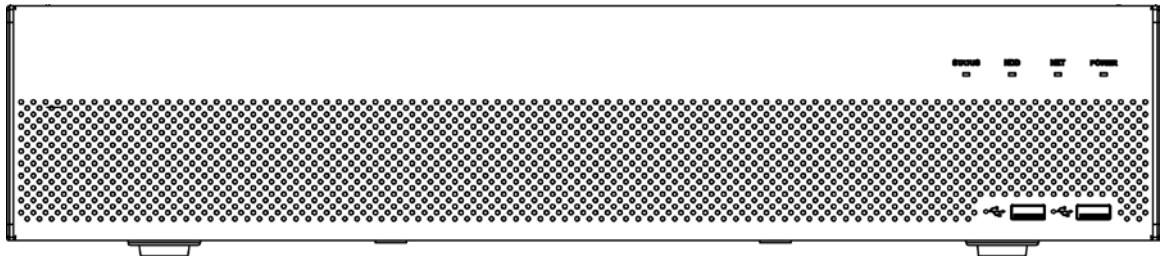



Table 2-3 Icons

Icon	Name	Function
STATUS	Status indicator light	The blue light is on when the Device is working properly.
HDD	HDD status indicator light	The blue light is on when the HDD malfunctions.
NET	Network status indicator light	The blue light is on when the network connection is abnormal.
POWER	Power status indicator light	The blue light is on when the power connection is normal.
	USB 2.0 port	Connect to peripheral USB 2.0 storage device, mouse, burner and more.

2.1.4 NVR21-W-4KS2 Series

The front panel is shown as below.



The figure is for reference only.

Figure 2-7 Front panel

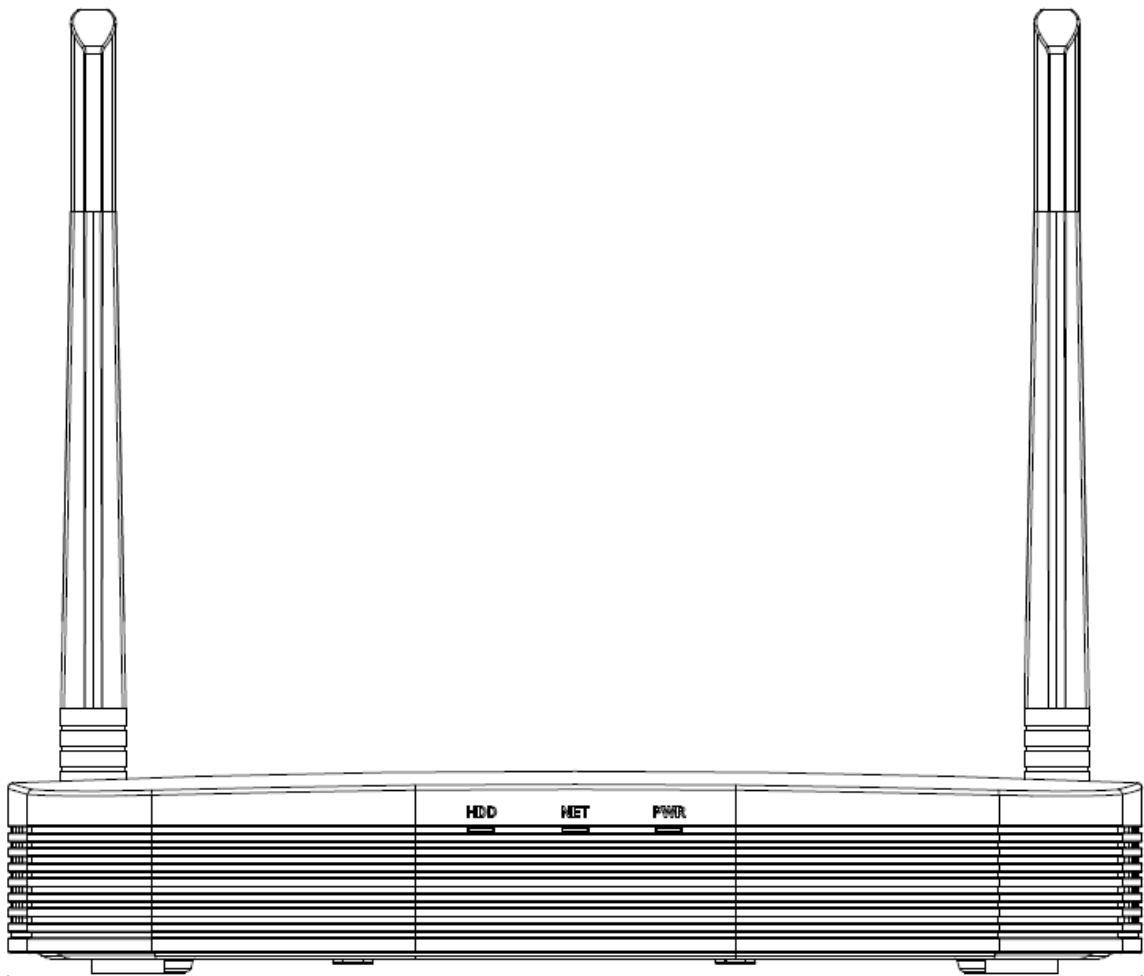

Table 2-4 Icons

Icon	Name	Function
HDD	HDD status indicator light	The blue light is on when the HDD malfunctions.
NET	Network status indicator light	The blue light is on when the network connection is abnormal.
PWR	Power status indicator light	The blue light is on when the power connection is normal.

2.1.5 NVR21HS-W-4KS2/NVR11HS-W-S2-CE/NVR11HS-W-S2-FCC Series

The front panel is shown as below.



The figure is for reference only.

Figure 2-8 Front panel

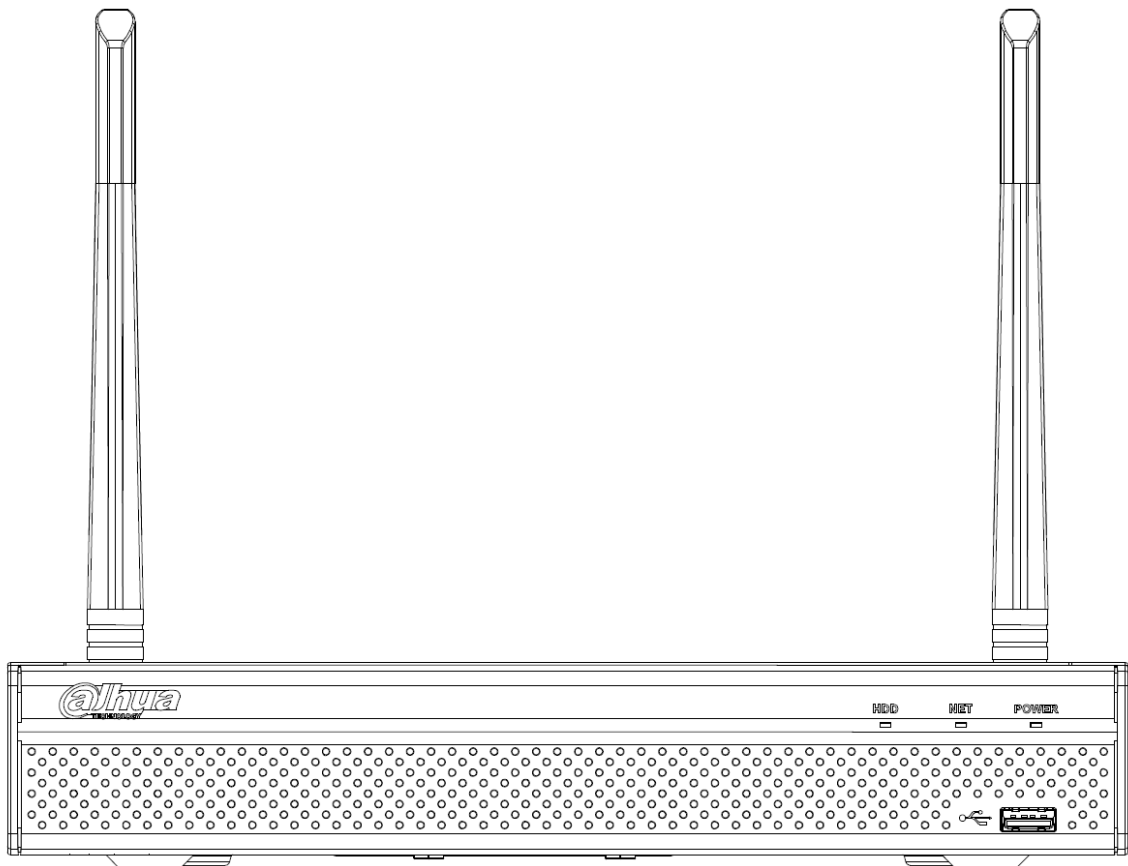



Table 2-5 Icons

Icon	Name	Function
HDD	HDD status indicator light	The blue light is on when the HDD is malfunction.
NET	Network status indicator light	The blue light is on when the network connection is abnormal.
POWER	Power status indicator light	The blue light is on when the power connection is normal.
	USB 2.0 port	Connect to peripheral USB storage device, mouse and more.

2.1.6

NVR21-I/NVR21-I2/NVR21-P-I/NVR21-P-I2/NVR21-8P-I/NVR21-8P-I2 Series



The figure is for reference only.

The NVR21-I/NVR21-I2 front panel is shown as below.

Figure 2-9 Front panel

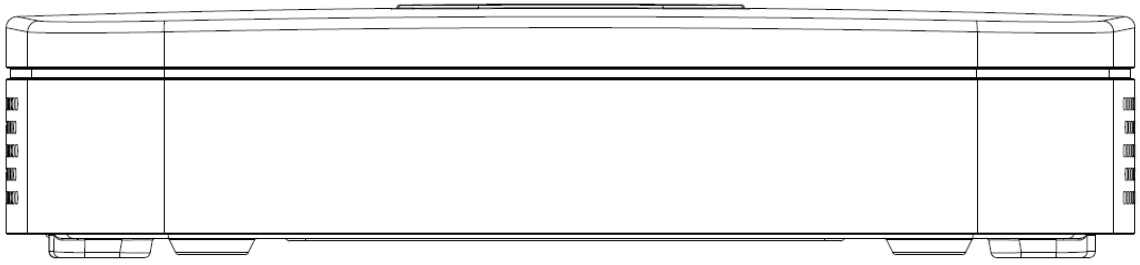

The NVR21-P-I/NVR21-P-I2 front panel is shown as below.

Figure 2-10 Front panel

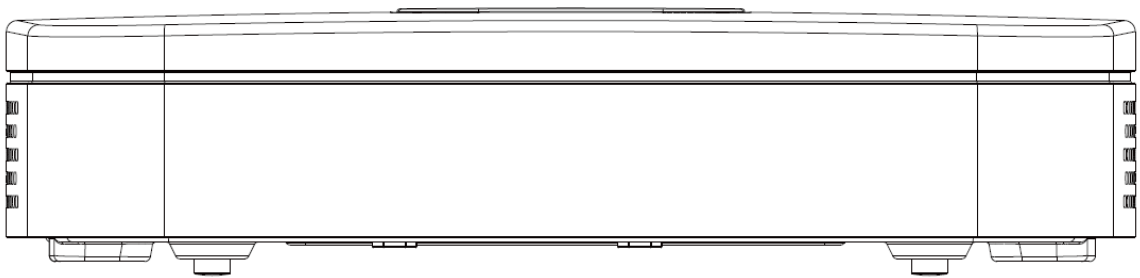

The NVR21-8P-I/NVR21-8P-I2 front panel is shown as below.

Figure 2-11 Front panel

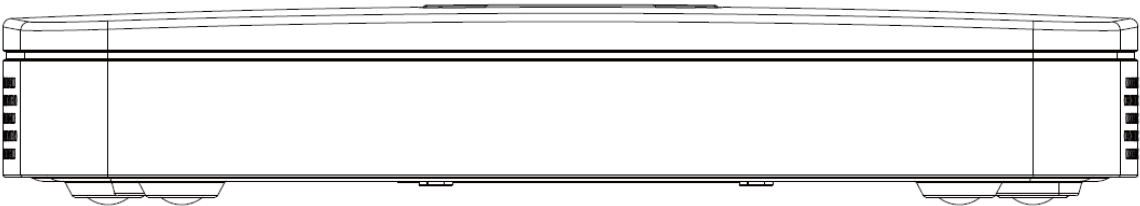

2.1.7

NVR22-I/NVR22-I2/NVR22-P-I/NVR22-P-I2/NVR22-8P-I/NVR22-8P-I2 /NVR22-16P-I/NVR22-16P-I2/NVR52-EI/NVR52-8P-EI/NVR52-16P-EI Series



The figure is for reference only.

The NVR22-I/NVR22-I2 front panel is shown as below.

Figure 2-12 Front panel

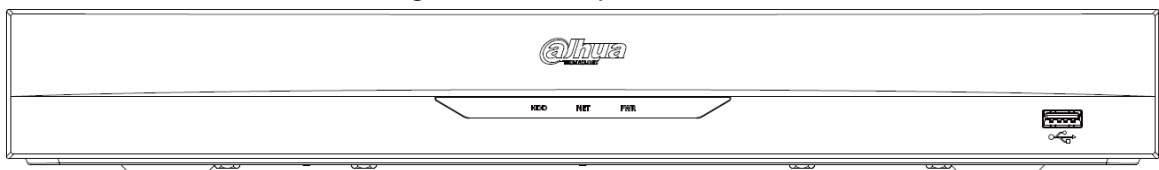

The NVR22-P-I/NVR22-P-I2 front panel is shown as below.

Figure 2-13 Front panel



The NVR22-8P-I/NVR22-8P-I2 front panel is shown as below.

Figure 2-14 Front panel



The NVR22-16P-I/NVR22-16P-I2 front panel is shown as below.

Figure 2-15 Front panel



The NVR52-EI/NVR52-8P-EI/NVR52-16P-EI front panel is shown as below.

Figure 2-16 Front panel

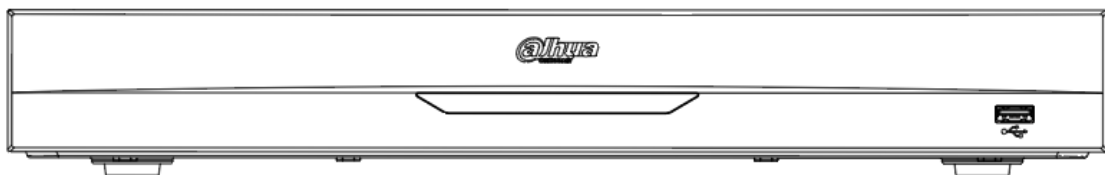



Table 2-6 Icons

Icon	Name	Function
HDD	HDD status indicator light	The blue light is on when the HDD malfunctions.
NET	Network status indicator light	The blue light is on when the network connection is abnormal.
PWR	Power status indicator light	The blue light is on when the power connection is OK.
	USB 2.0 port	Connect to peripheral USB 2.0 storage device, mouse, burner and more.

2.1.8

NVR21HS-I/NVR21HS-I2/NVR21HS-P-I/NVR21HS-P-I2/NVR21HS-8P-I /NVR21HS-8P-I2/NVR44-4KS2-I/NVR44-16P-4KS2-I Series



The figure is for reference only.

The front panel is shown as below.

Figure 2-17 Front panel

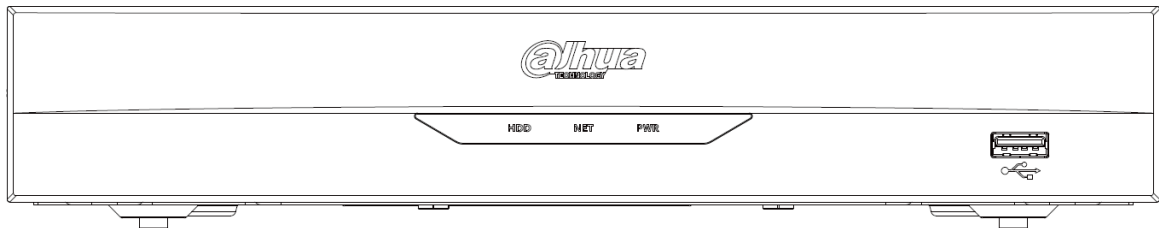



Table 2-7 Icons

Icon	Name	Function
HDD	HDD status indicator light	The blue light is on when the HDD malfunctions.
NET	Network status indicator light	The blue light is on when the network connection is abnormal.
PWR	Power status indicator light	The blue light is on when the power connection is OK.
	USB 2.0 port	Connect to peripheral USB 2.0 storage device, mouse, burner and more.

2.1.9 NVR48-I/NVR58-I/NVR58-I/L Series

The section takes NVR4832-I/NVR5864-I/NVR5864-I/L/NVR5832-I/NVR5832-I/L series as examples.



The figure is for reference only.

Figure 2-18 Front panel

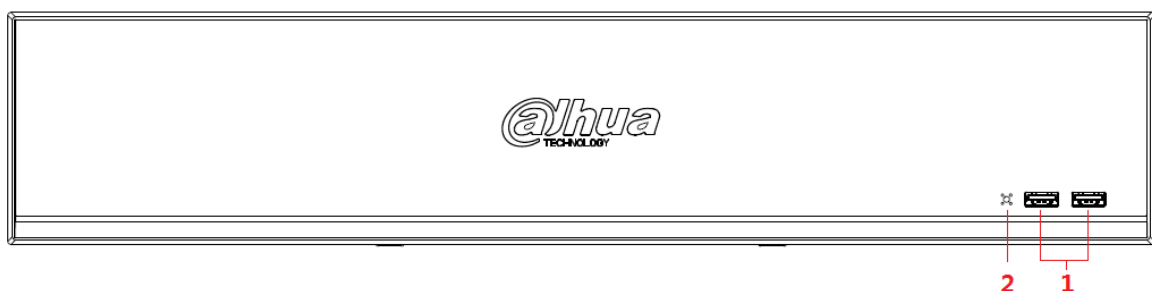

Table 2-8 Icons

No.	Port Name	Function
1	USB port	Connects to the external devices such as keyboard, mouse, and USB storage device.
2	IR indicator	Receives signals from the remote control.

2.1.10 NVR42-I/NVR44-I/NVR54-I/NVR54-I/L/NVR52-I/NVR52-I/L Series

The section uses

NVR4208-8P-I/NVR4216-I/NVR4216-16P-I/NVR4416-16P-I/NVR4432-I/NVR5432-16P-I/NVR5432-16P-I/L/NVR5216-16P-I/NVR5216-16P-I/L/NVR5216-8P-I/NVR5216-8P-I/L series as examples.



The figure is for reference only.

Figure 2-19 Front panel

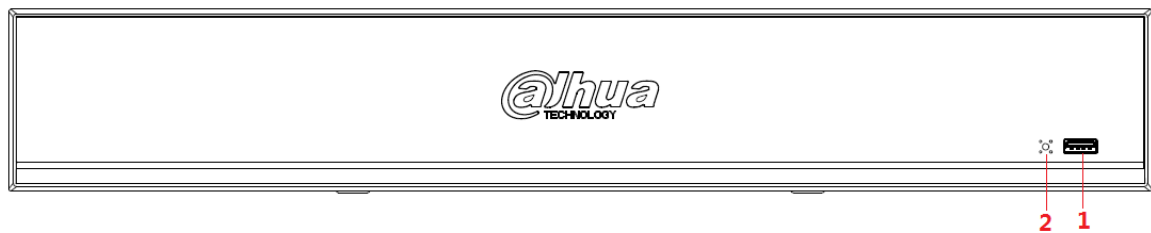

Table 2-9 Icons

No.	Port Name	Function
1	USB port	Connects to the external devices such as keyboard, mouse, and USB storage device.
2	IR indicator	Receives signals from the remote control.

2.1.11

NVR48-4KS2/I/NVR48-16P-4KS2/I/NVR54-EI/NVR54-16P-EI/NVR58-EI/NVR58-16P-EI Series



The figures are for reference only.

The NVR48-4KS2/I/NVR48-16P-4KS2/I series front panel is shown as below.

Figure 2-20 Front panel

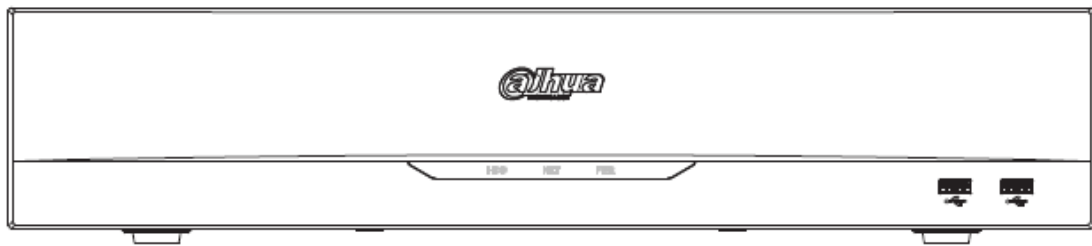

The NVR54-EI/ NVR54-16P-EI front panel is shown as below.

Figure 2-21 Front panel



The NVR58-EI/ NVR58-16P-EI front panel is shown as below.

Figure 2-22 Front panel

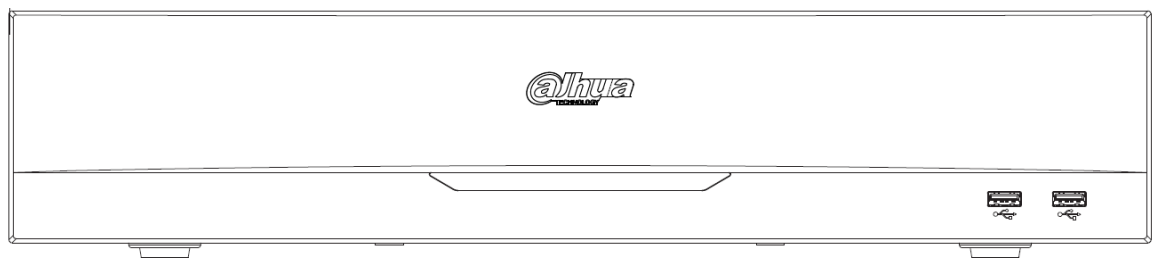

Table 2-10 Icons

Icon	Name	Function
HDD	HDD status indicator light	The blue light is on when the HDD malfunctions.
NET	Network status indicator light	The blue light is on when the network connection is abnormal.
PWR	Power status indicator light	The blue light is on when the power connection is normal.
	USB 2.0 port	Connect to peripheral USB 2.0 storage device, mouse, burner and more.

2.1.12 NVR608-32-4KS2 Series



The following figures are for reference only.

The NVR608-32-4KS2 front panel is shown as below.

Figure 2-23 Front panel

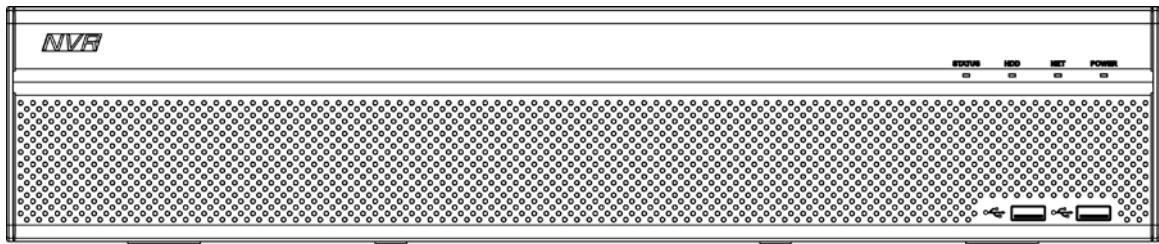



Table 2-11 Icons description

Icon	Name	Function
STATUS	Status indicator light	The blue light is on when the device is working properly.
HDD	HDD status indicator light	The blue light is on when the HDD malfunctions.
NET	Network status indicator light	The blue light is on when the network connection is abnormal.
POWER	Power status indicator light	The blue light is on when the power connection is normal.
	USB 2.0 port	Connect to peripheral USB 2.0 storage device, mouse, burner and more.

2.1.13

NVR608-64-4KS2/NVR608-128-4KS2/NVR608H-XI/NVR608RH-XI

Series

The NVR608-64-4KS2/NVR608-128-4KS2/NVR608H-32-XI/NVR608H-64-XI/NVR608H-128-XI/NVR608RH-32-XI/NVR608RH-64-XI/NVR608RH-128-XI front panel is shown as below.

Figure 2-24 Front panel

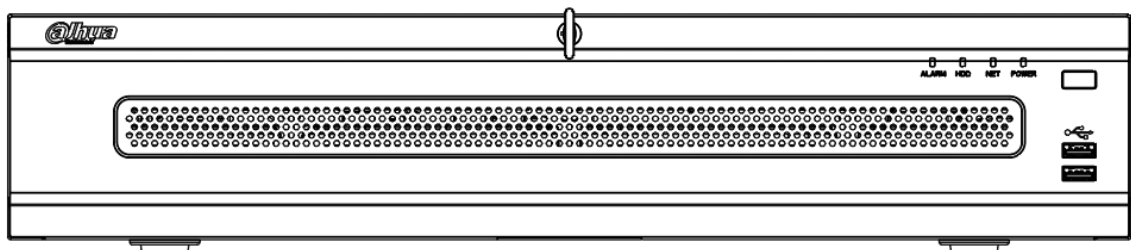

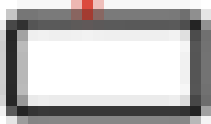

Table 2-12 Front panel description

Icon	Name
ALARM	Alarm indicator light
HDD	HDD status indicator light
NET	Network status indicator light

Icon	Name
POWER	Power status indicator light
	USB 2.0 port
	Power on-off button

2.1.14 NVR616-4KS2NVR616-4KS2Advanced 3U AI NVR Series/NVR50-EI Series



The following figures are for reference only.

For the product of LCD, the front panel of NVR616-4KS2 is shown as below.

Figure 2-25 Front panel

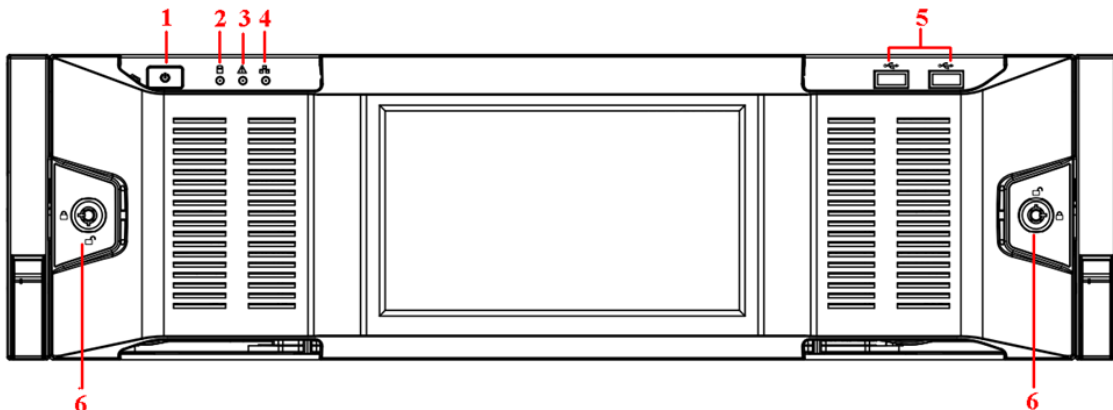



Table 2-13 Icons

No.	Name	Function
1	Power button	Press it once to turn on the device. Press it for a long time to turn off the device.  We do not recommend you turn off the Device in this way. Press power button for a long time or pull out the power cable might result in device auto restart.
2	System HDD Indicator light	The blue light becomes on after system booted up properly. In the system HDD, there are device important configuration file, factory default configuration file, and device initial boot up data.

No.	Name	Function
3	Alarm indicator light	The alarm indicator light becomes on once an alarm occurred. It becomes on via the software detection. The indicator light becomes on when there is a local alarm.
4	Network indicator light	The blue network indicator light is on after you connected the device to the network.
5	USB port	—
6	Front panel lock	—

For general NVR616-4KS2 series/NVR50-EI, the front panel is shown as below.

Figure 2-26 Front panel

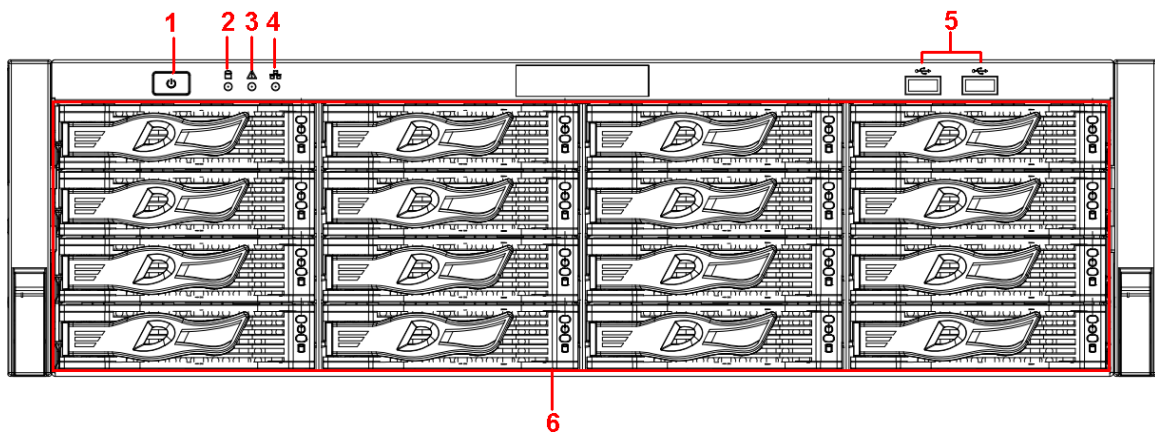



Table 2-14 Icons

No.	Name	Function
1	Power button	Press it once to turn on the device. Press it for a long time to turn off the device.  We do not recommend you turn off the Device in this way. Press power button for a long time or pull out the power cable might result in device auto restart.
2	System HDD Indicator light	The blue light becomes on after system booted up properly. In the system HDD, there are device important configuration file, factory default configuration file, device initial boot up data.
3	Alarm indicator light	The alarm indicator light becomes on once an alarm occurred. It becomes on via the software detection. The indicator light becomes on when there is a local alarm.
4	Network indicator light	The blue network indicator light is on after you connected the device to the network.
5	USB port	—
6	16 HDD slot	—

After you remove the front panel, you can see there are 16 HDDs. From the left to the right and from

the top to the bottom, it ranges from 1~4, 5~8, 9~12, 13~16.

You can see there are two indicator lights on the HDD bracket.

- The power indicator light is at the top. The light is yellow after you connected the device to the power.
- The read-write indicator light is at the bottom. The blue light flashes when system is reading or writing the data.

Figure 2-27 Front panel

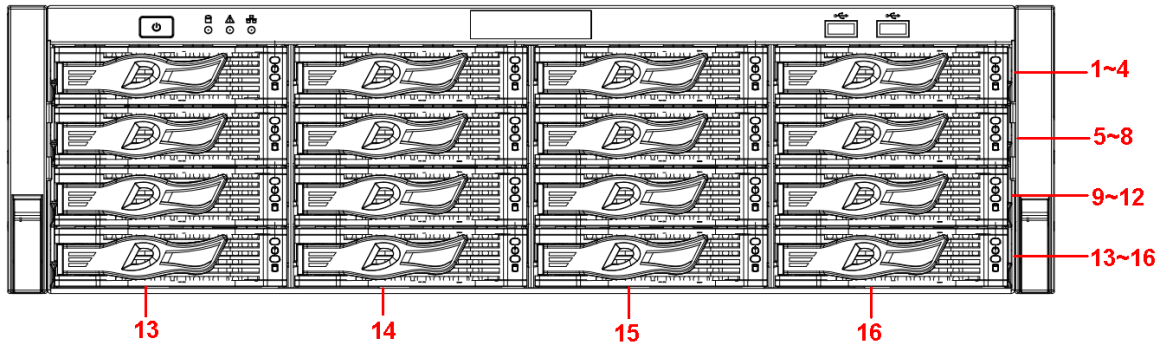

2.2 Rear Panel

2.2.1 NVR21-4KS2/NVR21-P-4KS2/NVR21-8P-4KS2 Series

The NVR21-4KS2 is shown as below.

Figure 2-28 Rear panel

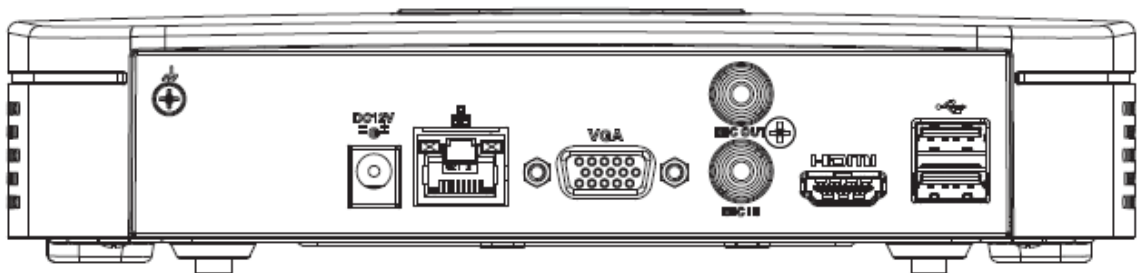

The NVR21-P-4KS2 is shown as below.

Figure 2-29 Rear panel

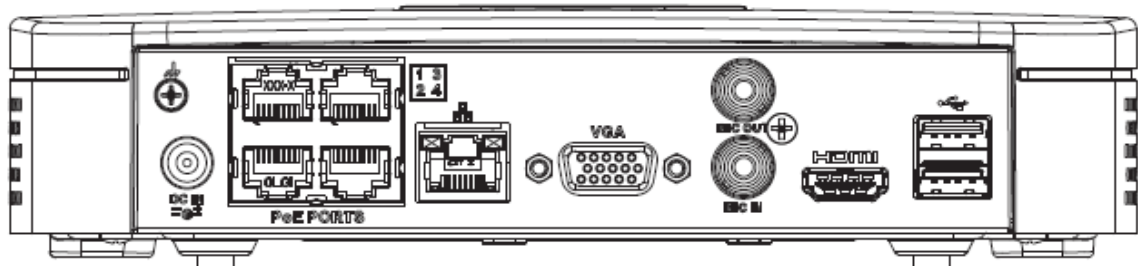

The NVR21-8P-4KS2 is shown as below.

Figure 2-30 Rear panel

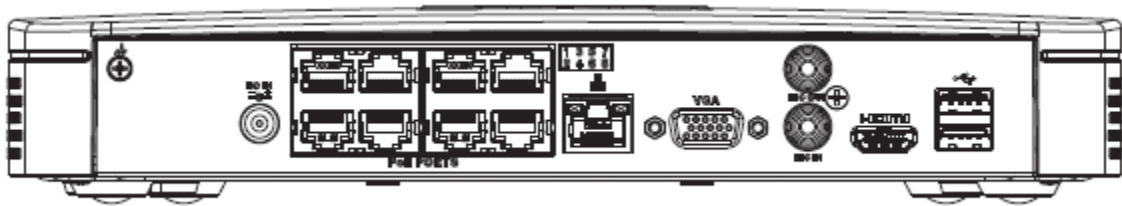

Table 2-15 Ports

Port Name	Connection	Function
DC 12V /	Power input port	Power socket. <ul style="list-style-type: none"> For NVR21-S2/21-4KS2, input 12 VDC/2 A. For NVR21-P-S2/21-P-4KS2, input 48 VDC/1.25 A. For NVR21-8P-S2/21-8P-4KS2, input 48 VDC/2 A.
	Network port	10/100 Mbps self-adaptive Ethernet port. Connect to the network cable.
	USB port	USB port. Connect to mouse, USB storage device and more.
HDMI	High Definition Media Interface	High definition audio and video signal output port. It transmits uncompressed high definition video and multiple-channel data to the HDMI port of the display device. HDMI version is 1.4.
VGA	VGA video output port	VGA video output port. Output analog video signal. It can connect to the monitor to view analog video.
MIC IN	Audio input port	Bidirectional talk input port. It is to receive the analog audio signal output from the devices such as microphone, pickup.
MIC OUT	Audio output port	Audio output port. It is to output the analog audio signal to the devices such as the sound box. <ul style="list-style-type: none"> Bidirectional talk output. Audio output on 1-window video monitor. Audio output on 1-window video playback.
	GND	Ground end.
PoE PORTS	PoE port	Built-in switch. Support PoE function. For PoE series product, you can use this port to provide power to the network camera.

2.2.2

**NVR11HS-S3H/NVR11HS-P-S3H/NVR11HS-8P-S3H/NVR21HS-4KS2/
NVR21HS-P-4KS2/NVR21HS-8P-4KS2/NVR41HS-4KS2/NVR41HS-P-4**

KS2/NVR41HS-8P-4KS2/NVR41HS-4KS2/L/NVR41HS-P-4KS2/L/NVR41HS-8P-4KS2/L/NVR21HS-S3/NVR21HS-P-S3/NVR21HS-8P-S3

The NVR11HS-S3H/NVR21HS-4KS2/NVR41HS-4KS2/NVR41HS-4KS2/L/NVR21HS-S3 series rear panel is shown as below.

Figure 2-31 Rear panel

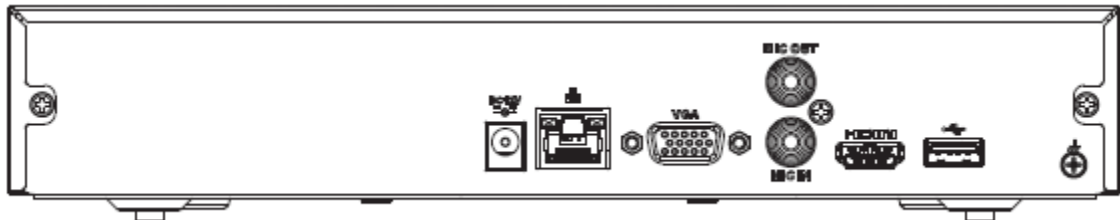

The NVR11HS-P-S3H/NVR21HS-P-4KS2/NVR41HS-P-4KS2/NVR41HS-P-4KS2/L/NVR21HS-P-S3 series rear panel is shown as below.

Figure 2-32 Rear panel

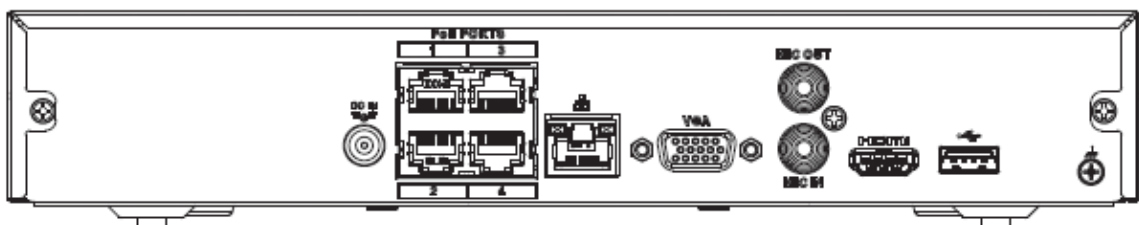

The NVR11HS-8P-S3H/NVR21HS-8P-4KS2/NVR41HS-8P-4KS2/NVR41HS-8P-4KS2/L/NVR21HS-8P-S3 series rear panel is shown as below.

Figure 2-33 Rear panel

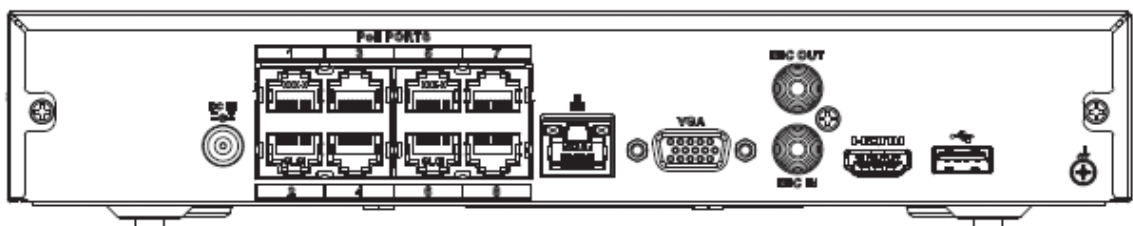





Table 2-16 Ports

Port Name	Connection	Function
	Power input port	Power socket. <ul style="list-style-type: none"> For NVR11HS-P-S3H/NVR21HS-4KS2/NVR41HS-4KS2 series, input 12 VDC/2 A. For NVR11HS-P-S3H/NVR21HS-P-4KS2/NVR41HS-4KS2 series, input 48 VDC/1.25 A. For NVR11HS-8P-4KS2/NVR21HS-8P-4KS2/NVR41HS-4KS2 series, input 48 VDC/2 A.

Port Name	Connection	Function
	Network port	10/100 Mbps self-adaptive Ethernet port. Connect to the network cable.
	USB port	USB port. Connect to mouse, USB storage device and more.
HDMI	High Definition Media Interface	High definition audio and video signal output port. It transmits uncompressed high definition video and multiple-channel data to the HDMI port of the display device. HDMI version is 1.4.
VGA	VGA video output port	VGA video output port. Output analog video signal. It can connect to the monitor to view analog video.
MIC IN	Audio input port	Bidirectional talk input port. It is to receive the analog audio signal output from the devices such as microphone, pickup.
MIC OUT	Audio output port	Audio output port. It is to output the analog audio signal to the devices such as the sound box. <ul style="list-style-type: none"> • Bidirectional talk output. • Audio output on 1-window video monitor. • Audio output on 1-window video playback.
	GND	Ground end.
PoE PORTS	PoE port	Built-in switch. Support PoE function. For PoE series product, you can use this port to provide power to the network camera.

2.2.3 NVR22-4KS2/NVR22-P-4KS2/NVR22-8P-4KS2 Series

The NVR22-4KS2 series rear panel is shown as below.

Figure 2-34 Rear panel

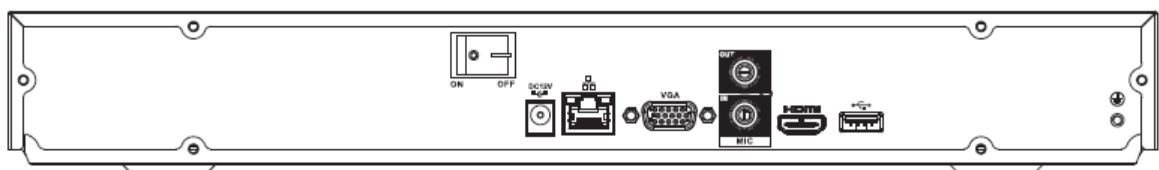

The NVR22-P-4KS2 series rear panel is shown as below.

Figure 2-35 Rear panel

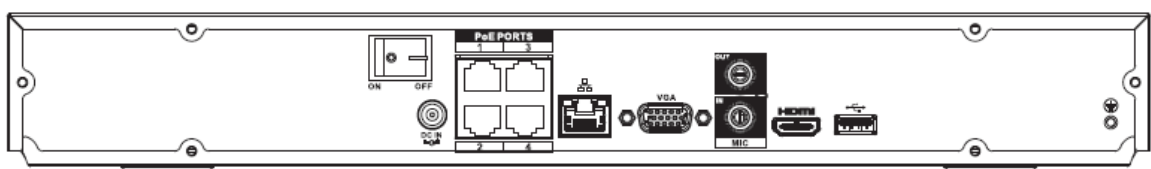

The NVR22-8P-4KS2 series rear panel is shown as below.

Figure 2-36 Rear panel

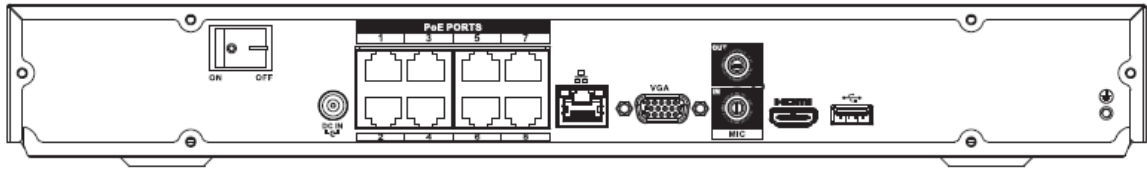





Table 2-17 Rear panel description

Port Name	Connection	Function
	Power input port	Power socket. <ul style="list-style-type: none"> For NVR22-4KS2 general series, input 12 VDC/4 A. For NVR22-P-4KS2 series, input 48 VDC/1.5 A. For NVR22-8P-4KS2 series, input 53 VDC 120 W.
	Network port	10/100 Mbps self-adaptive Ethernet port. Connect to the network cable.
	USB port	USB port. Connect to mouse, USB storage device and more.
HDMI	High Definition Media Interface	High definition audio and video signal output port. It transmits uncompressed high definition video and multiple-channel data to the HDMI port of the display device. HDMI version is 1.4.
VGA	VGA video output port	VGA video output port. Output analog video signal. It can connect to the monitor to view analog video.
MIC IN	Audio input port	Bidirectional talk input port. It is to receive the analog audio signal output from the devices such as microphone, pickup.
MIC OUT	Audio output port	Audio output port. It is to output the analog audio signal to the devices such as the sound box. <ul style="list-style-type: none"> Bidirectional talk output. Audio output on 1-window video monitor. Audio output on 1-window video playback.
	GND	Ground end.
PoE PORTS	PoE port	Built-in switch. Support PoE function. For PoE series product, you can use this port to provide power to the network camera.

2.2.4

NVR52-4KS2/NVR52-8P-4KS2/NVR52-16P-4KS2/NVR52-24P-4KS2/NVR52-8P-4KS2E/NVR52-16P-4KS2E/NVR52-EI/NVR52-8P-EI/NVR52-16P-EI1

The NVR52-4KS2 series rear panel is shown as below.

Figure 2-37 Rear panel

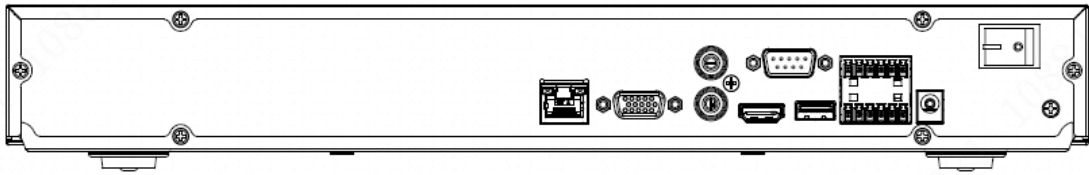

The NVR52-8P-4KS2 series rear panel is shown as below.

Figure 2-38 Rear panel

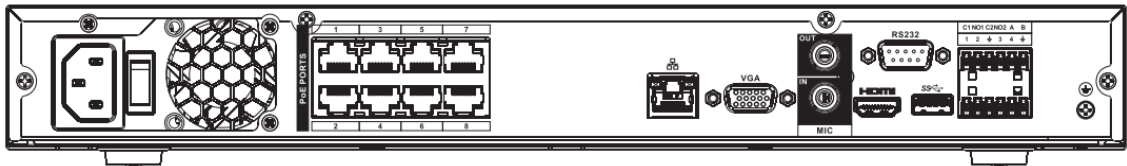

The NVR52-16P-4KS2 series rear panel is shown as below.

Figure 2-39 Rear panel

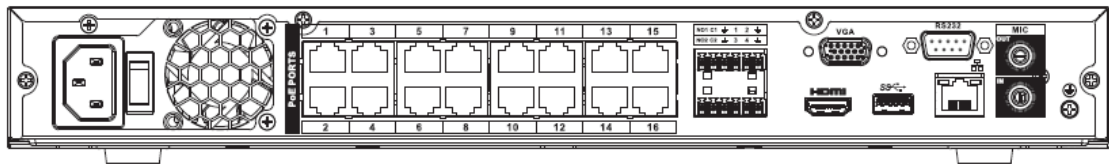

The NVR52-24P-4KS2 series rear panel is shown as below.

Figure 2-40 Rear panel

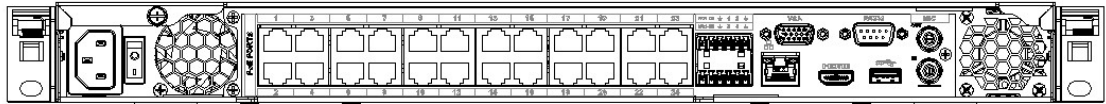

The NVR52-8P-4KS2E/52-16P-4KS2E series rear panel is shown as below.



The following figure takes NVR52-16P-4KS2E series as an example. NVR52-8P-4KS2E has 8 ePoE ports only.

Figure 2-41 Rear panel

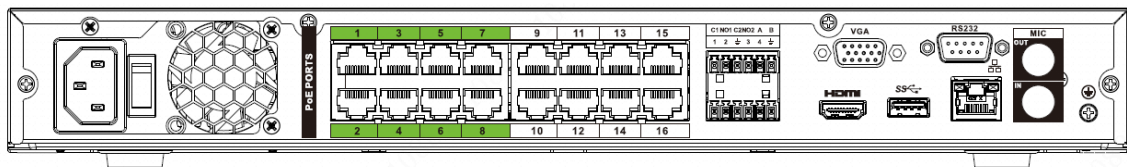

Figure 2-42 Rear panel

The NVR52-EI series rear panel is shown as below.

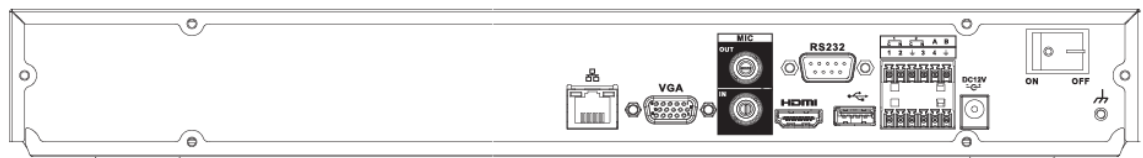

Figure 2-43 Rear panel

The NVR52-8P-EI series rear panel is shown as below.



Figure 2-44 Rear panel

The NVR52-16P-EI series rear panel is shown as below.

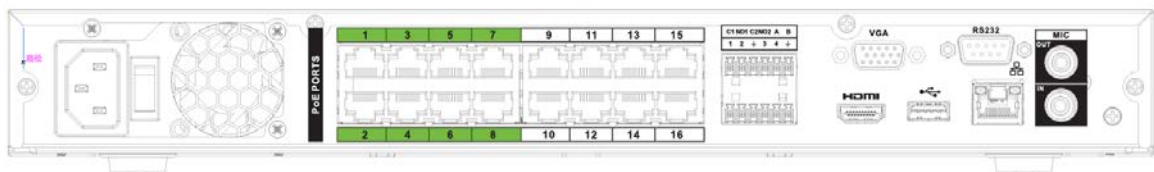

Table 2-18 Ports

Icon	Port Name	Function
	Network port	10/100/1000 Mbps self-adaptive Ethernet port. Connect to the network cable.
HDMI	High Definition Media Interface	High definition audio and video signal output port. It transmits uncompressed high definition video and multiple-channel data to the HDMI port of the display device. HDMI version is 1.4.
	USB 3.0 port	USB 3.0 port. Connect to mouse, USB storage device, USB burner and more.
RS-232	RS-232 debug COM	It is for general COM debug to configure IP address or transfer transparent COM data.
VGA	VGA video output port	VGA video output port. Output analog video signal. It can connect to the monitor to view analog video.
MIC IN	Audio input port	Bidirectional talk input port. It is to receive the analog audio signal output from the devices such as microphone, pickup.
MIC OUT	Audio output port	Audio output port. It is to output the analog audio signal to the devices such as the sound box. <ul style="list-style-type: none"> • Bidirectional talk output. • Audio output on 1-window video monitor. • Audio output on 1-window video playback.
1-8	Alarm input port 1-8	<ul style="list-style-type: none"> • There are two groups. The first group is from port 1 to port 4; the second group is from port 5 to port 8. They are to receive the signal from the external alarm source. There are two types; NO (normal open)/NC (normal close). • When your alarm input device is using external power, please make sure the device and the NVR have the same ground.
	GND	Alarm input ground port.
NO1-NO3	Alarm output port	<ul style="list-style-type: none"> • 3 groups of alarm output ports. (Group 1: port

Icon	Port Name	Function
C1-C3	1-3	NO1-C1; Group 2: port NO2-C2; Group 3: port NO3-C3). Output alarm signal to the alarm device. Please make sure there is power to the external alarm device. <ul style="list-style-type: none"> • NO: Normal open alarm output port. • C: Alarm output public end.
A	RS-485 communication port	RS485_A port. It is the cable A. You can connect to the control devices such as speed dome PTZ.
B		RS485_B. It is the cable B. You can connect to the control devices such as speed dome PTZ.
	Power input port	Input 12 VDC/4 A.
Power switch	—	Power on/off button.
PoE PORTS	—	Built-in Switch. Support PoE or ePoE function. <ul style="list-style-type: none"> • For ePoE series product, port 1 to port 8 are the ePoE ports. ePoE port supports 300 meters@100Mbps, 800 meters@10Mbps. Port 9 to port 16 are general PoE ports. • The 8 PoE series product supports total 130 W. • The 16 PoE series product supports total 130 W.

2.2.5

NVR54-4KS2/NVR58-4KS2/NVR54-16P-4KS2/NVR58-16P-4KS2/NVR54-24P-4KS2/NVR58-16P-4KS2E

The NVR54-4KS2/NVR58-4KS2 series rear panel is shown as below.

Figure 2-45 Rear panel

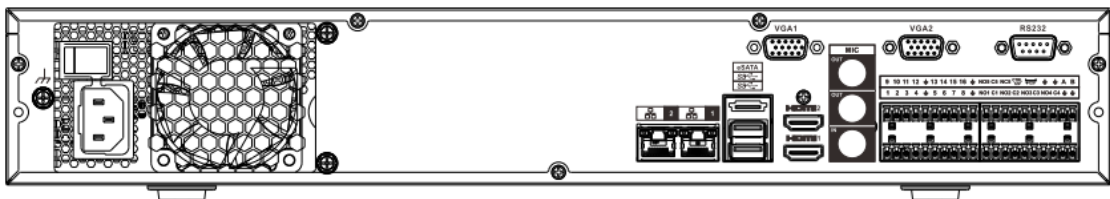

The NVR54-16P-4KS2/NVR58-16P-4KS2 series rear panel is shown as below.

Figure 2-46 Rear panel

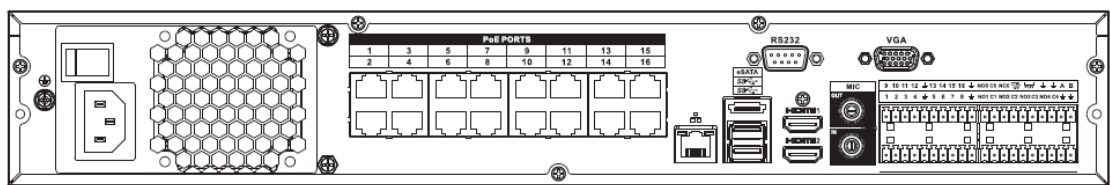

The NVR54-24P-4KS2 series rear panel is shown as below.

Figure 2-47 Rear panel

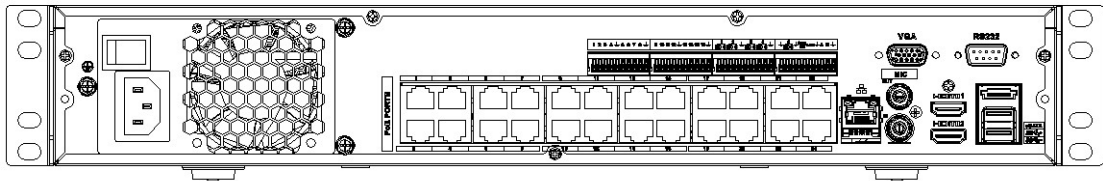

The NVR54-16P-4KS2E series rear panel is shown as below.

Figure 2-48 Rear panel

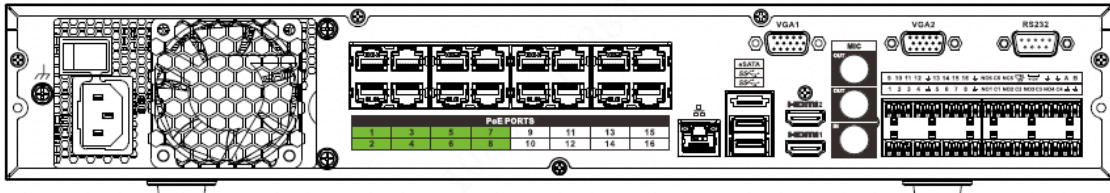

The NVR58-16P-4KS2E series rear panel is shown as below.

Figure 2-49 Rear panel

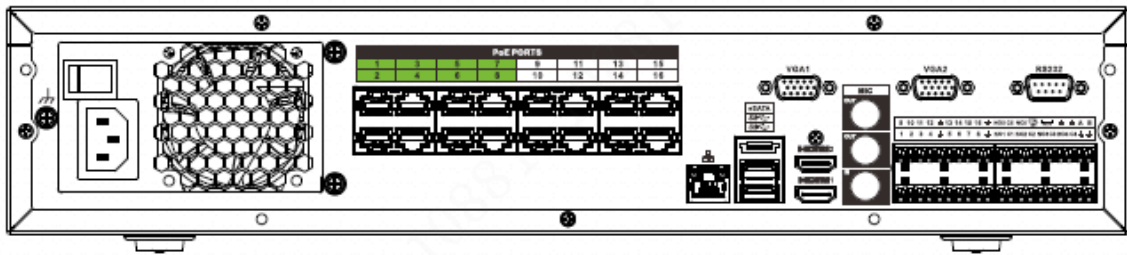
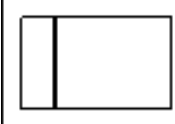
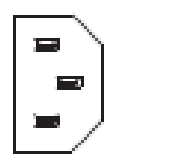



Table 2-19 Rear panel description

Name		Function
	Power switch	Power on-off button
	Power input port	Input 100–240 VAC.
	Network port	10/100/1000 Mbps self-adaptive Ethernet port. Connect to the network cable.
eSATA	eSATA port	External SATA port. It can connect to the device of the SATA port. Please jump the HDD when there is peripheral connected HDD.
	USB port	USB port. Connect to mouse, USB storage device, USB burner and more.
HDMI	High Definition Media Interface	High definition audio and video signal output port. It transmits uncompressed high definition video and multiple-channel data to the HDMI port of the display device. HDMI version is 1.4b.

Name		Function	
MIC IN	Audio input port	Bidirectional talk input port. It is to receive the analog audio signal output from the devices such as microphone, pickup.	
MIC OUT	Audio output port	Audio output port. It is to output the analog audio signal to the devices such as the sound box. <ul style="list-style-type: none"> • Bidirectional talk output. • Audio output on 1-window video monitor. • Audio output on 1-window video playback. 	
1-16	Alarm input port 1-16	<ul style="list-style-type: none"> • There are four groups. The first group is from port 1 to port 4, the second group is from port 5 to port 8, the third group is from 9 to 12, and the fourth group is from 13 to 16. They are to receive the signal from the external alarm source. There are two types; NO (normal open)/NC (normal close). • When your alarm input device is using external power, please make sure the device and the NVR have the same ground. 	
	Ground	Alarm input ground end.	
NO1-NO5	Alarm output port 1-5	<ul style="list-style-type: none"> • 5 groups of alarm output ports. (Group 1: port NO1-C1, Group 2:port NO2-C2, Group 3: port NO3-C3, Group 4: port NO4-C4, Group 5: port NO5, C5, NC5). Output alarm signal to the alarm device. Please make sure there is power to the external alarm device. • NO: Normal open alarm output port. • C: Alarm output public end. • NC: Normal close alarm output port. 	
C1-C5			
NC5			
A	RS-485 communication port	RS485_A port. It is the cable A. You can connect to the control devices such as speed dome PTZ.	
B		RS485_B. It is the cable B. You can connect to the control devices such as speed dome PTZ.	
CTRL (CTRL 12 V)	—	Controller 12 V power output. It is to control the on-off alarm relay output. It can be used to control the device alarm output. At the same time, it can also be used as the power input source of some devices such as the alarm detector.	The two ports serve as another group of alarm output ports.
P (+12 V)	—	+12 V power output port. It can provide the power to some peripheral devices such as the camera or the alarm device. Please note the supplying power shall be below 1 A.	
RS-232	RS-232 debug COM	It is for general COM debug to configure IP address or transfer transparent COM data.	
VGA	VGA video output port	VGA video output port. Output analog video signal. It can connect to the monitor to view analog video.	

Name		Function
PoE PORTS	—	Built-in Switch. Support PoE or ePoE function. For ePoE series product, port 1 to port 8 are the ePoE ports. ePoE port supports 300 meters@100Mbps, 800 meters@10Mbps. Port 9 to port 16 are general PoE ports. The 16 PoE series supports total 150W.

2.2.6

NVR41-4KS2/NVR41-P-4KS2/NVR41-8P-4KS2/NVR41-4KS2/L/NVR41-P-4KS2/L/NVR41-8P-4KS2/L/NVR21-S3/NVR21-P-S3/NVR21-8P-S3

The NVR41-4KS2/NVR41-4KS2/L/NVR21-S3 series rear panel is shown as below.

Figure 2-55 Rear panel

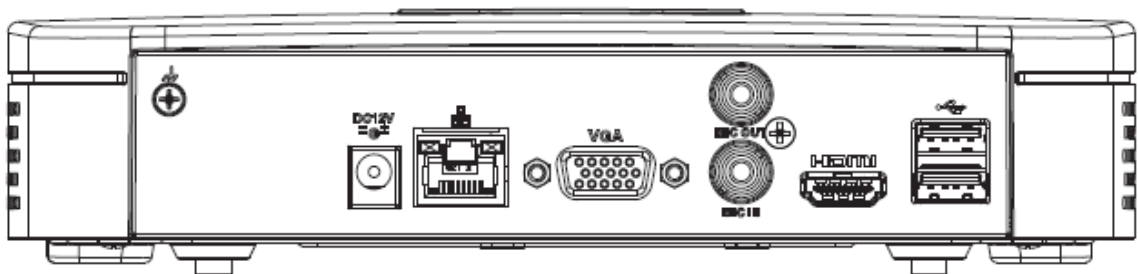

The NVR41-P-4KS2/NVR41-P-4KS2/L series rear panel is shown as below.

Figure 2-56 Rear panel

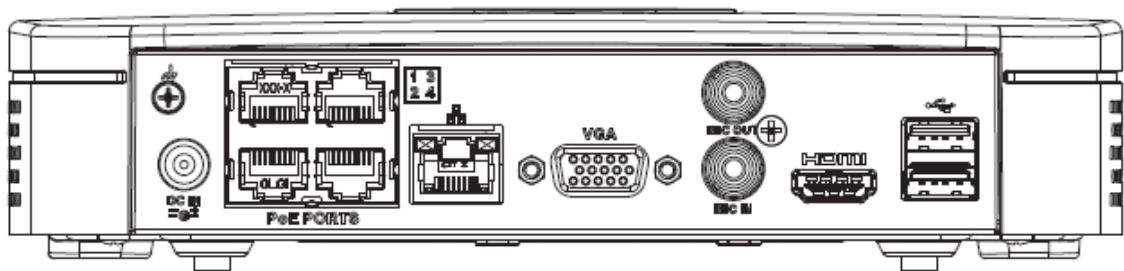

The NVR41-8P-4KS2/NVR41-8P-4KS2/L series rear panel is shown as below.

Figure 2-57

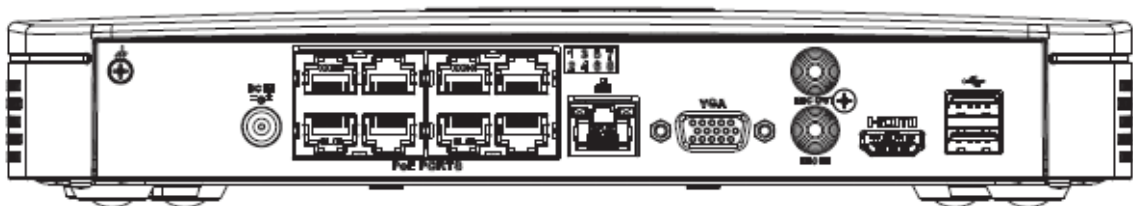

Table 2-20 Ports

Port Name	Connection	Function
	USB port	USB port. Connect to mouse, USB storage device, USB burner and more.
	Network port	10/100 Mbps self-adaptive Ethernet port. Connect to the network cable.
HDMI	High Definition Media Interface	High definition audio and video signal output port. It transmits uncompressed high definition video and multiple-channel data to the HDMI port of the display device. HDMI version is 1.4.
VGA	VGA video output port	VGA video output port. Output analog video signal. It can connect to the monitor to view analog video.
	GND	Ground end.
	Power input port	Power socket. <ul style="list-style-type: none"> • For NVR41-4KS2: 12 VDC/2 A power. • For NVR41-P-4KS2: 48 VDC/72 W power. • For NVR41-8P-4KS2: 48 VDC/96 W power.
MIC IN	Audio input port	Bidirectional talk input port. It is to receive the analog audio signal output from the devices such as microphone, pickup.
MIC OUT	Audio output port	Audio output port. It is to output the analog audio signal to the devices such as the sound box. <ul style="list-style-type: none"> • Bidirectional talk output. • Audio output on 1-window video monitor. • Audio output on 1-window video playback.
PoE PORTS	PoE port	Built-in switch. Support PoE function. For PoE series product, you can use this port to provide power to the network camera.

2.2.7

NVR42-4KS2/NVR42-P-4KS2/NVR42-8P-4KS2/NVR42-16P-4KS2/NVR42-4KS2/L/NVR42-P-4KS2/L/NVR42-8P-4KS2/L/NVR42-16P-4KS2/L Series

The NVR42-4KS2/NVR42-4KS2/L series rear panel is shown as below.

Figure 2-58 Rear panel

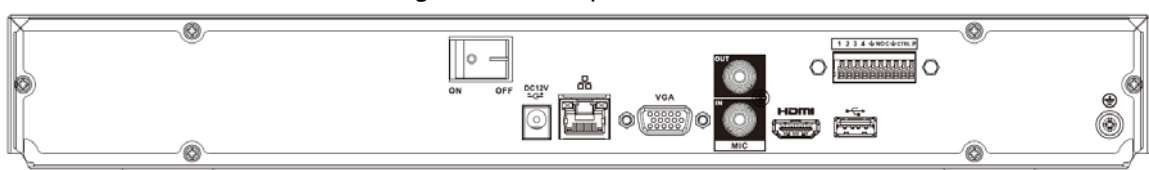

The NVR42-P-4KS2/NVR42-P-4KS2/L series rear panel is shown as below.

Figure 2-59 Rear panel

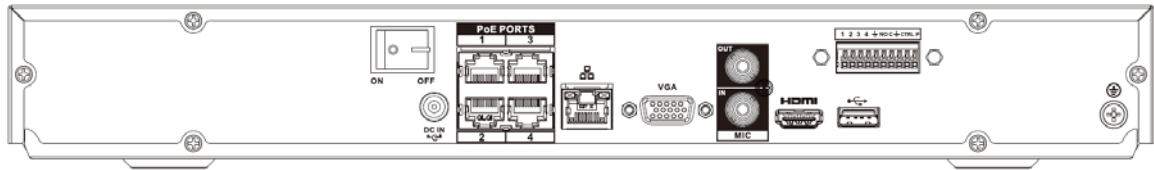

The NVR42-8P-4KS2/NVR42-8P-4KS2/L series rear panel is shown as below.

Figure 2-60 Rear panel

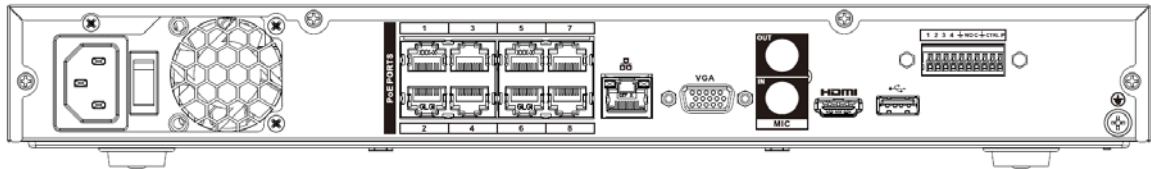

The NVR42-16P-4KS2/NVR42-16P-4KS2/L series rear panel is shown as below.

Figure 2-61 Rear panel

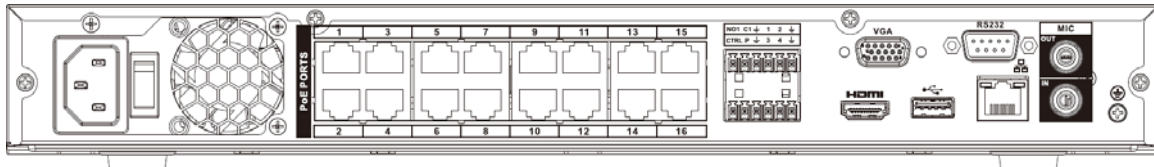



Table 2-21 Rear panel description

Name		Function
	Power switch	Power on/off button.
	Power input port	Input 12 VDC/4 A. For NVR42-4KS2 series product only.
		Switch power port. Input 48 VDC/96 W. For NVR42-P-4KS2 series product only.
		Input 90~264-12 VAC 5 A/52 V 2.5 A-190 W. For NVR42-8P-4KS2/NVR42-16P-4KS24K 1U (S2) with 8 PoE ports/ 4K 1U (S2) with 16 PoE ports series product only.
MIC IN	Audio input port	Bidirectional talk input port. It is to receive the analog audio signal output from the devices such as microphone, pickup.
MIC OUT	Audio output port	Audio output port. It is to output the analog audio signal to the devices such as the sound box. <ul style="list-style-type: none"> • Bidirectional talk output. • Audio output on 1-window video monitor. • Audio output on 1-window video playback.
1-4	Alarm input port 1-4	<ul style="list-style-type: none"> • There are two types; NO (normal open)/NC (normal close). • When your alarm input device is using external power, please make sure the device and the NVR have the same ground.
	GND	Alarm input ground port.

Name		Function
N1, N2	Alarm output port 1-2	<ul style="list-style-type: none"> 2 groups of alarm output ports. (Group 1: port NO1-C1, Group 2: port NO2-C2). Output alarm signal to the alarm device. Please make sure there is power to the external alarm device. NO: Normal open alarm output port. C: Alarm output public end.
C1, C2		
A	RS-485 communication port	RS485_A port. It is the cable A. You can connect to the control devices such as speed dome PTZ.
B		RS485_B. It is the cable B. You can connect to the control devices such as speed dome PTZ.
	Network port	10/100/1000 Mbps self-adaptive Ethernet port. Connect to the network cable.
	USB port	USB port. Connect to mouse, USB storage device, USB burner and more.
RS-232	RS-232 debug COM	It is for general COM debug to configure IP address or transfer transparent COM data.
HDMI	High Definition Media Interface	High definition audio and video signal output port. It transmits uncompressed high definition video and multiple-channel data to the HDMI port of the display device. HDMI version is 1.4.
VGA	VGA video output port	VGA video output port. Output analog video signal. It can connect to the monitor to view analog video.
PoE PORTS	/	Built-in Switch. Support PoE. For PoE series product, you can use this port to provide power to the network camera.

2.2.8

NVR44-4KS2/NVR44-16P-4KS2/NVR44-4KS2/L/NVR44-16P-4KS2/L/ NVR44-4KS2/I/NVR44-16P-4KS2/I Series

The NVR44-4KS2/NVR44-4KS2/L/NVR44-4KS2/I series rear panel is shown as below.

Figure 2-62 Rear panel



The NVR44-16P-4KS2/NVR44-16P-4KS2/L/NVR44-16P-4KS2/I series rear panel is shown as below.

Figure 2-63 Rear panel

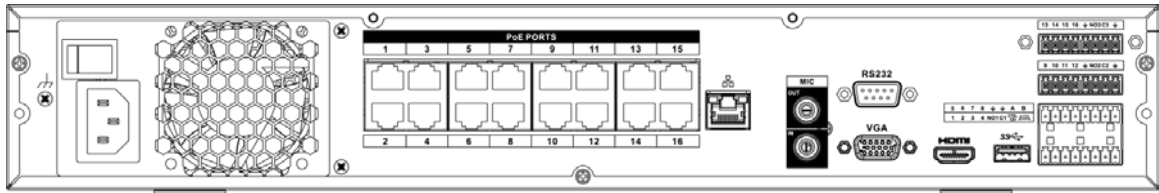

Table 2-22 Ports

Name		Function
Power switch	—	Power on-off button
Power input port	—	90~264-12 VAC 12.5 A/-53 V 2.83 A
MIC IN	Audio input port	Bidirectional talk input port. It is to receive the analog audio signal output from the devices such as microphone, pickup.
MIC OUT	Audio output port	Audio output port. It is to output the analog audio signal to the devices such as the sound box. <ul style="list-style-type: none"> • Bidirectional talk output. • Audio output on 1-window video monitor. • Audio output on 1-window video playback.
VIDEO OUT	Video output port	CVBS output
1-16	Alarm input port 1-16	<ul style="list-style-type: none"> • There are four groups. The first group is from port 1 to port 4, the second group is from port 5 to port 8, the third group is from 9 to 12, and the fourth group is from 13 to 16. They are to receive the signal from the external alarm source. There are two types; NO (normal open)/NC (normal close). • When your alarm input device is using external power, please make sure the device and the NVR have the same ground.
⏏	Video output port	CVBS output
NO1-NO3	Alarm output port 1-3	<ul style="list-style-type: none"> • 3 groups of alarm output ports. (Group 1: port NO1-C1; Group 2: port NO2-C2; Group 3: port NO3-C3). Output alarm signal to the alarm device. Please make sure there is power to the external alarm device. • NO: Normal open alarm output port. • C: Alarm output public end.
C1-C3		
A	RS-485 communication port	RS485_A port. It is the cable A. You can connect to the control devices such as speed dome PTZ.
B		RS485_B. It is the cable B. You can connect to the control devices such as speed dome PTZ.

Name		Function	
CTRL (CTRL 12 V)	—	Controller 12 V power output. It is to control the on-off alarm relay output. It can be used to control the device alarm output. At the same time, it can also be used as the power input source of some devices such as the alarm detector.	<p>The two ports serve as another group of alarm output ports.</p>
P (+12 V)	—	+12 V power output port. It can provide the power to some peripheral devices such as the camera or the alarm device. Please note the supplying power shall be below 1 A.	
	Network port	10/100/1000 Mbps self-adaptive Ethernet port. Connect to the network cable.	
eSATA	eSATA port	External SATA port. It can connect to the device of the SATA port. Please jump the HDD when there is peripheral connected HDD.	
	USB 2.0 port	USB 2.0 port. Connect to mouse, USB storage device, USB burner and more.	
RS-232	RS-232 debug COM	It is for general COM debug to configure IP address or transfer transparent COM data.	
HDMI	High Definition Media Interface	High definition audio and video signal output port. It transmits uncompressed high definition video and multiple-channel data to the HDMI port of the display device. HDMI version is 1.3.	
VGA	VGA video output port	VGA video output port. Output analog video signal. It can connect to the monitor to view analog video.	
PoE PORTS	PoE port	Built-in Switch. Support PoE. For PoE series product, you can use this port to provide power to the network camera.	

2.2.9

NVR48-4KS2/NVR48-16P-4KS2/NVR48-4KS2/L/NVR48-16P-4KS2/L/NVR48-4KS2/I/NVR48-16P-4KS2/I Series

The NVR48-4KS2/NVR48-4KS2/L/NVR48-4KS2/I series rear panel is shown as below.

Figure 2-64 Rear panel

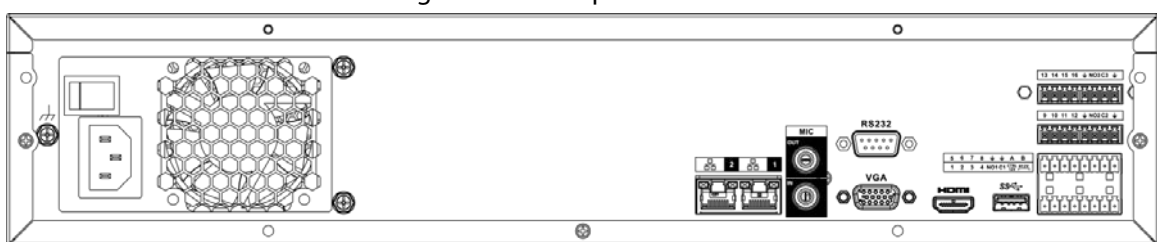

The NVR48-16P-4KS2/NVR48-16P-4KS2/L/NVR48-16P-4KS2/I series rear panel is shown as below.

Figure 2-65 Rear panel

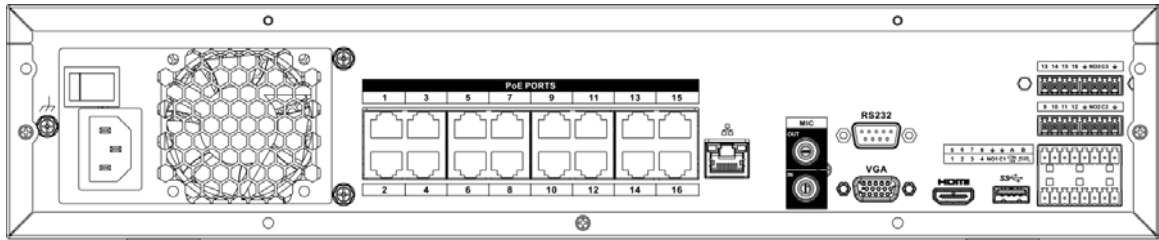





Table 2-23 Ports

Name		Function
Power switch	—	Power on-off button.
Power input port	—	90~264-12 VAC 12.5 A/-53 V 2.83 A.
MIC IN	Audio input port	Bidirectional talk input port. It is to receive the analog audio signal output from the devices such as microphone, pickup.
MIC OUT	Audio output port	Audio output port. It is to output the analog audio signal to the devices such as the sound box. <ul style="list-style-type: none"> • Bidirectional talk output. • Audio output on 1-window video monitor. • Audio output on 1-window video playback.
VIEDEO OUT	Video output port	CVBS output.
1-16	Alarm input port 1-16	<ul style="list-style-type: none"> • There are four groups. The first group is from port 1 to port 4, the second group is from port 5 to port 8, the third group is from 9 to 12, and the fourth group is from 13 to 16. They are to receive the signal from the external alarm source. There are two types; NO (normal open)/NC (normal close). • When your alarm input device is using external power, please make sure the device and the NVR have the same ground.
	GND	Alarm input ground port.
NO1-NO3	Alarm output port 1-3	<ul style="list-style-type: none"> • 3 groups of alarm output ports. (Group 1: port NO1-C1; Group 2: port NO2-C2; Group 3: port NO3-C3). Output alarm signal to the alarm device. Please make sure there is power to the external alarm device. • NO: Normal open alarm output port. • C: Alarm output public end.
C1-C3		
A	RS-485 communication port	RS485_A port. It is the cable A. You can connect to the control devices such as speed dome PTZ.
B		RS485_B. It is the cable B. You can connect to the control devices such as speed dome PTZ.

Name		Function	
CTRL (CTRL 12 V)	—	Controller 12 V power output. It is to control the on-off alarm relay output. It can be used to control the device alarm output. At the same time, it can also be used as the power input source of some devices such as the alarm detector.	 The two ports serve as another group of alarm output ports.
P (+12 V)	—	+12 V power output port. It can provide the power to some peripheral devices such as the camera or the alarm device. Please note the supplying power shall be below 1 A.	
	Network port	One 10/100/1000 Mbps self-adaptive Ethernet port. Connect to the network cable.	
eSATA	eSATA port	External SATA port. It can connect to the device of the SATA port. Please jump the HDD when there is peripheral connected HDD.	
	USB port	USB port. Connect to mouse, USB storage device, USB burner and more.	
RS-232	RS-232 debug COM	It is for general COM debug to configure IP address or transfer transparent COM data.	
HDMI	High Definition Media Interface	High definition audio and video signal output port. It transmits uncompressed high definition video and multiple-channel data to the HDMI port of the display device. HDMI version is 1.4.	
VGA	VGA video output port	VGA video output port. Output analog video signal. It can connect to the monitor to view analog video.	
PoE PORTS	PoE port	Built-in Switch. Support PoE. For PoE series product, you can use this port to provide power to the network camera.	

2.2.10 NVR21-W-4KS2 Series

Figure 2-66 Rear panel

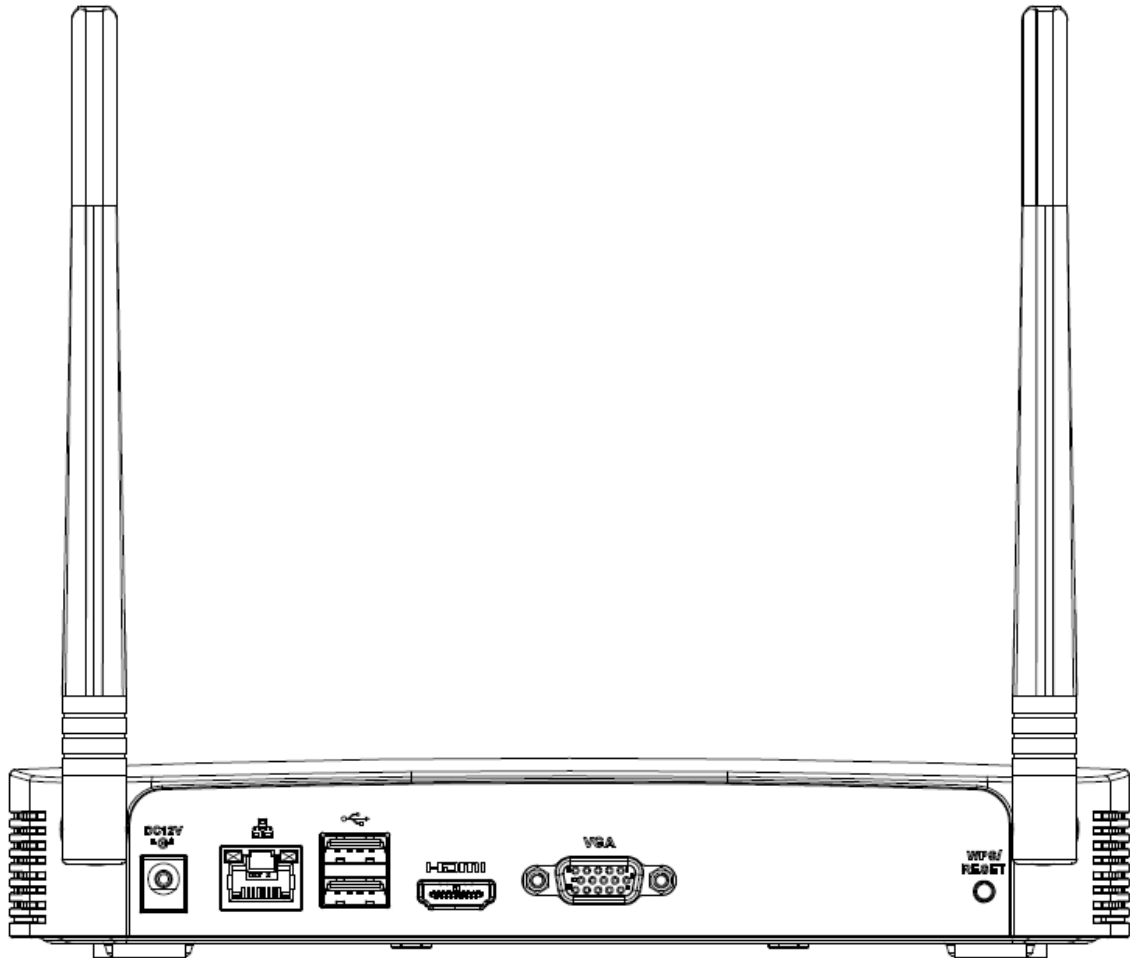





Table 2-24 Ports

Port Name	Connection	Function
	USB 2.0 port	USB 2.0 port. Connect to mouse, USB storage device, USB burner and more.
	Network port	10/100 Mbps self-adaptive Ethernet port. Connect to the network cable.
HDMI	High Definition Media Interface	High definition audio and video signal output port. It transmits uncompressed high definition video and multiple-channel data to the HDMI port of the display device. HDMI version is 1.4.
VGA	VGA video output port	VGA video output port. Output analog video signal. It can connect to the monitor to view analog video.
	Power input port	Input 12 VDC/2 A.

Port Name	Connection	Function
WPS/RESET	Reset/WPS function	Device Wi-Fi reset and WPS function button: <ul style="list-style-type: none"> • Hold down this button for 5 seconds and above to restore Wi-Fi AP to defaults. • Press this button for less than 2 seconds, and then press the WPS button of Wi-Fi IPC, the device and Wi-Fi IPC can be connected.

2.2.11 NVR21HS-W-4KS2Series

Figure 2-67 Rear panel



Table 2-25 Ports

Icon	Name	Function
	Power input socket	Power socket. Input 12 VDC/2 A.
	Network port	10/100 Mbps self-adaptive Ethernet port. Connect to the network cable.
	USB 2.0 port	USB 2.0 port. Connect to mouse, USB storage device, and more.
HDMI	High Definition Media Interface	High definition audio and video signal output port. It transmits uncompressed high definition video and multiple-channel data to the HDMI port of the display device. HDMI version is 1.4.

Icon	Name	Function
VGA	VGA video output port	VGA video output port. Output analog video signal. It can connect to the monitor to view analog video.
⏏	GND	Ground end.
WPS/RESET	Reset/WPS function	Device Wi-Fi reset and WPS function button: <ul style="list-style-type: none"> ● Hold down this button for 5 seconds and above to restore Wi-Fi AP to defaults. ● Press this button for less than 2 seconds, and then press the WPS button of Wi-Fi IPC, the device and Wi-Fi IPC can be connected.

2.2.12 NVR21-I/NVR21-I2 Series



The figure is for reference only.

Figure 2-68 Rear panel

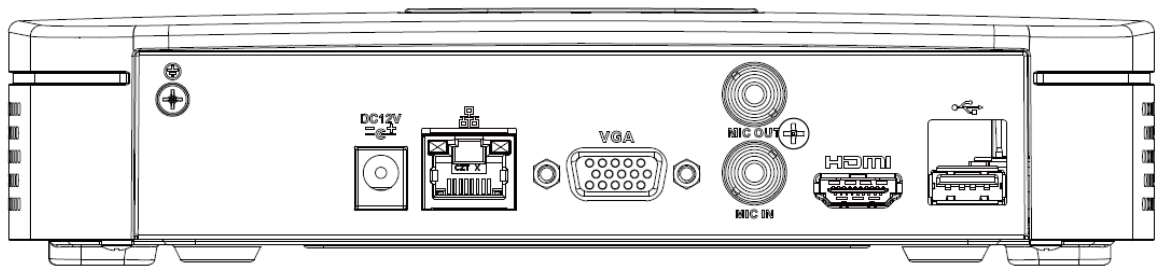

Table 2-26 Ports

Port Name	Connection	Function
	USB port	USB port. Connect to mouse, USB storage device and more.
HDMI	High Definition Media Interface	High definition audio and video signal output port. It transmits uncompressed high definition video and multiple-channel data to the HDMI port of the display device. HDMI version is 1.4.
MIC IN	Audio input port	Bidirectional talk input port. It is to receive the analog audio signal output from the devices such as microphone, pickup.
MIC OUT	Audio output port	Audio output port. It is to output the analog audio signal to the devices such as the sound box. <ul style="list-style-type: none"> ● Bidirectional talk output. ● Audio output on 1-window video monitor. ● Audio output on 1-window video playback.
VGA	VGA video output port	VGA video output port. Output analog video signal. It can connect to the monitor to view analog video.
	Network port	10/100 Mbps self-adaptive Ethernet port. Connect to the network cable.

Port Name	Connection	Function
DC 12V 	Power input port	Power socket.
	GND	Ground end.

2.2.13 NVR22-I/NVR22-I2 Series

The rear panel is shown as below.



The figure is for reference only.

Figure 2-69 Rear panel

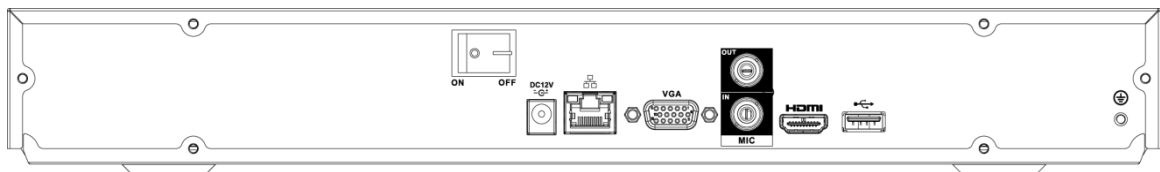

Table 2-27 Ports

Port Name	Connection	Function
	GND	Ground end.
	USB port	USB port. Connect to mouse, USB storage device and more.
HDMI	High Definition Media Interface	High definition audio and video signal output port. It transmits uncompressed high definition video and multiple-channel data to the HDMI port of the display device. HDMI version is 1.4.
MIC IN	Audio input port	Bidirectional talk input port. It is to receive the analog audio signal output from the devices such as microphone, pickup.
MIC OUT	Audio output port	Audio output port. It is to output the analog audio signal to the devices such as the sound box. <ul style="list-style-type: none"> • Bidirectional talk output. • Audio output on 1-window video monitor. • Audio output on 1-window video playback.
VGA	VGA video output port	VGA video output port. Output analog video signal. It can connect to the monitor to view analog video.
	Network port	10/100 Mbps self-adaptive Ethernet port. Connect to the network cable.
DC 12V 	Power input port	Power socket.
	Power switch	Power on/off button.

2.2.14 NVR21-P-I/NVR21-P-I2 Series



The figure is for reference only.

Figure 2-70 Rear panel

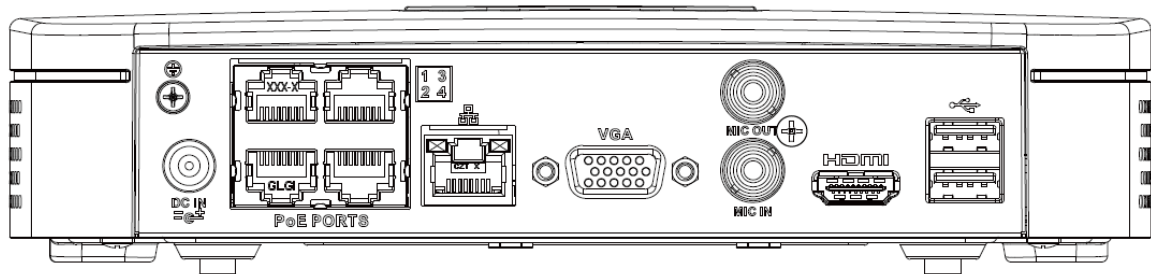

Table 2-28 Ports

Port Name	Connection	Function
	USB port	USB port. Connect to mouse, USB storage device and more.
HDMI	High Definition Media Interface	High definition audio and video signal output port. It transmits uncompressed high definition video and multiple-channel data to the HDMI port of the display device. HDMI version is 1.4.
MIC IN	Audio input port	Bidirectional talk input port. It is to receive the analog audio signal output from the devices such as microphone, pickup.
MIC OUT	Audio output port	Audio output port. It is to output the analog audio signal to the devices such as the sound box. <ul style="list-style-type: none"> • Bidirectional talk output. • Audio output on 1-window video monitor. • Audio output on 1-window video playback.
VGA	VGA video output port	VGA video output port. Output analog video signal. It can connect to the monitor to view analog video.
	Network port	10/100 Mbps self-adaptive Ethernet port. Connect to the network cable.
PoE PORTS	PoE port	Built-in switch. Support PoE function. For PoE series product, you can use this port to provide power to the network camera.
	Power input port	Power socket.
	GND	Ground end.

2.2.15 NVR22-P-I/NVR22-P-I2 Series

The rear panel is shown as below.



The figure is for reference only.

Figure 2-71 Rear panel

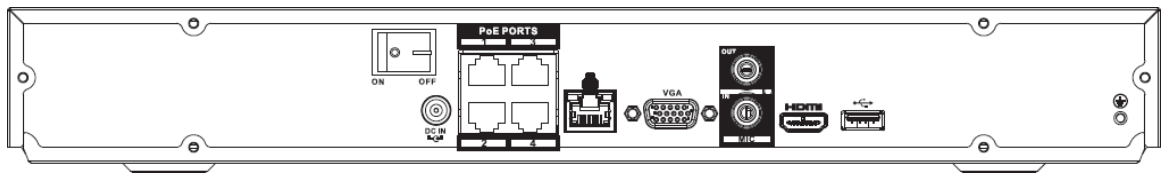

Table 2-29 Ports

Port Name	Connection	Function
	GND	Ground end.
	USB port	USB port. Connect to mouse, USB storage device and more.
HDMI	High Definition Media Interface	High definition audio and video signal output port. It transmits uncompressed high definition video and multiple-channel data to the HDMI port of the display device. HDMI version is 1.4.
MIC IN	Audio input port	Bidirectional talk input port. It is to receive the analog audio signal output from the devices such as microphone, pickup.
MIC OUT	Audio output port	Audio output port. It is to output the analog audio signal to the devices such as the sound box. <ul style="list-style-type: none"> • Bidirectional talk output. • Audio output on 1-window video monitor. • Audio output on 1-window video playback.
VGA	VGA video output port	VGA video output port. Output analog video signal. It can connect to the monitor to view analog video.
	Network port	10/100 Mbps self-adaptive Ethernet port. Connect to the network cable.
PoE PORTS	PoE port	Built-in switch. Support PoE function. For PoE series product, you can use this port to provide power to the network camera.
	Power input port	Power socket.
	Power switch	Power on/off button.

2.2.16 NVR21-8P-I/NVR21-8P-I2 Series



The figure is for reference only.

Figure 2-72 Rear panel

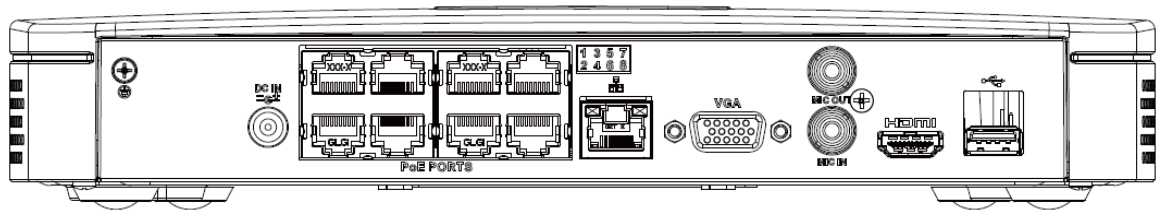

Table 2-30 Ports

Port Name	Connection	Function
	USB port	USB port. Connect to mouse, USB storage device and more.
HDMI	High Definition Media Interface	High definition audio and video signal output port. It transmits uncompressed high definition video and multiple-channel data to the HDMI port of the display device. HDMI version is 1.4.
MIC IN	Audio input port	Bidirectional talk input port. It is to receive the analog audio signal output from the devices such as microphone, pickup.
MIC OUT	Audio output port	Audio output port. It is to output the analog audio signal to the devices such as the sound box. <ul style="list-style-type: none"> • Bidirectional talk output. • Audio output on 1-window video monitor. • Audio output on 1-window video playback.
VGA	VGA video output port	VGA video output port. Output analog video signal. It can connect to the monitor to view analog video.
	Network port	10/100 Mbps self-adaptive Ethernet port. Connect to the network cable.
PoE PORTS	PoE port	Built-in switch. Support PoE function. For PoE series product, you can use this port to provide power to the network camera.
	Power input port	Power socket.
	GND	Ground end.

2.2.17 NVR22-8P-I/NVR22-8P-I2 Series



The figure is for reference only.

Figure 2-73 Rear panel

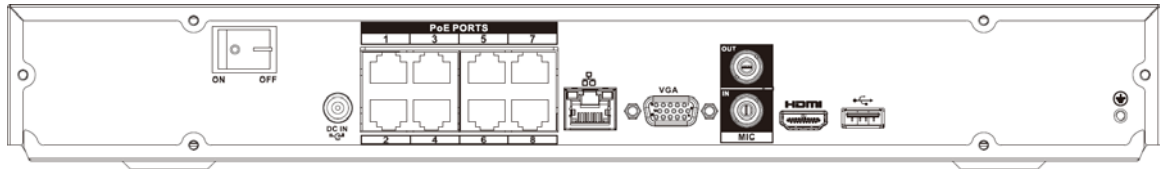

Table 2-31 Ports

Port Name	Connection	Function
	GND	Ground end.
	USB port	USB port. Connect to mouse, USB storage device and more.
HDMI	High Definition Media Interface	High definition audio and video signal output port. It transmits uncompressed high definition video and multiple-channel data to the HDMI port of the display device. HDMI version is 1.4.
MIC IN	Audio input port	Bidirectional talk input port. It is to receive the analog audio signal output from the devices such as microphone, pickup.
MIC OUT	Audio output port	Audio output port. It is to output the analog audio signal to the devices such as the sound box. <ul style="list-style-type: none"> • Bidirectional talk output. • Audio output on 1-window video monitor. • Audio output on 1-window video playback.
VGA	VGA video output port	VGA video output port. Output analog video signal. It can connect to the monitor to view analog video.
	Network port	10/100 Mbps self-adaptive Ethernet port. Connect to the network cable.
PoE PORTS	PoE port	Built-in switch. Support PoE function. For PoE series product, you can use this port to provide power to the network camera.
	Power input port	Power socket.
	Power switch	Power on/off button.

2.2.18 NVR22-16P-I/NVR22-8P-I2 Series



The figure is for reference only.

Figure 2-74 Rear panel

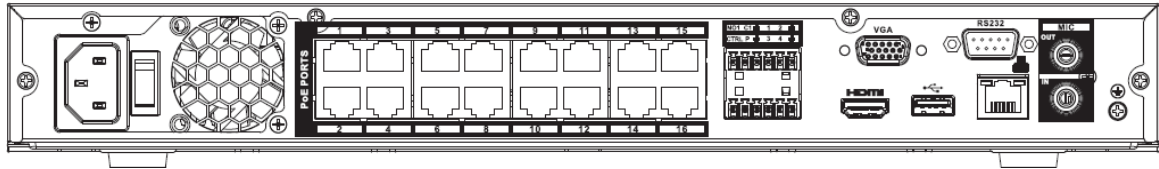
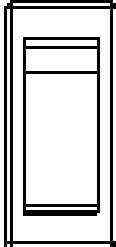



Table 2-32 Ports

Port Name	Connection	Function
	GND	Ground end.
MIC IN	Audio input port	Bidirectional talk input port. It is to receive the analog audio signal output from the devices such as microphone, pickup.
MIC OUT	Audio output port	Audio output port. It is to output the analog audio signal to the devices such as the sound box. <ul style="list-style-type: none"> • Bidirectional talk output. • Audio output on 1-window video monitor. • Audio output on 1-window video playback.
RS-232	RS-232 debug COM	It is for general COM debug to configure IP address or transfer transparent COM data.
	Network port	10/100 Mbps self-adaptive Ethernet port. Connect to the network cable.
	USB port	USB port. Connect to mouse, USB storage device and more.
VGA	VGA video output port	VGA video output port. Output analog video signal. It can connect to the monitor to view analog video.
HDMI	High Definition Media Interface	High definition audio and video signal output port. It transmits uncompressed high definition video and multiple-channel data to the HDMI port of the display device. HDMI version is 1.4.
NO1	Alarm output port	<ul style="list-style-type: none"> • 1 group of alarm output ports (port NO1–C1). Output alarm signal to the alarm device. Please make sure there is power to the external alarm device. • NO: Normal open alarm output port. • C: Alarm output public end.
C1		
CTRL	—	Controllable power supply output. Control the output of the on-off button alarm relay. It controls the alarm device with the presence or absence of voltage. It can also be used as power input for some alarm devices such as alarm detectors. <div style="text-align: right;"> <p>The two ports serve as another group of alarm</p> </div>

Port Name	Connection	Function
P	—	Power output port. It can provide power to some peripheral devices such as camera and alarm device. Make sure the power supply of peripheral device shall be below 1 A. output ports.
PoE PORTS	PoE port	Built-in switch. Support PoE function. For PoE series product, you can use this port to provide power to the network camera.
	Power switch	Power on/off button.
	Power input port	Power socket.

2.2.19 NVR21HS-I/NVR21HS-I2 Series



The figure is for reference only.

Figure 2-75 Rear panel

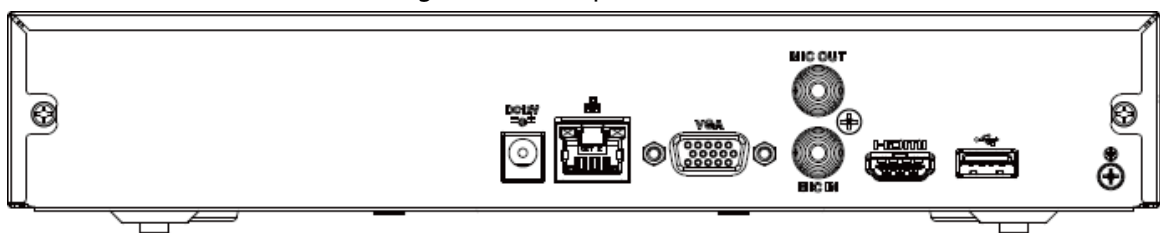





Table 2-33 Rear panel description

Port Name	Connection	Function
	GND	Ground end.
	USB port	USB port. Connect to mouse, USB storage device and more.
HDMI	High Definition Media Interface	High definition audio and video signal output port. It transmits uncompressed high definition video and multiple-channel data to the HDMI port of the display device. HDMI version is 1.4.
MIC IN	Audio input port	Bidirectional talk input port. It is to receive the analog audio signal output from the devices such as microphone, pickup.

Port Name	Connection	Function
MIC OUT	Audio output port	Audio output port. It is to output the analog audio signal to the devices such as the sound box. <ul style="list-style-type: none"> • Bidirectional talk output. • Audio output on 1-window video monitor. • Audio output on 1-window video playback.
VGA	VGA video output port	VGA video output port. Output analog video signal. It can connect to the monitor to view analog video.
	Network port	10/100 Mbps self-adaptive Ethernet port. Connect to the network cable.
PoE PORTS	PoE port	Built-in switch. Support PoE function. For PoE series product, you can use this port to provide power to the network camera.
	Power input port	Power socket.

2.2.20 NVR21HS-P-I/NVR21HS-P-I2 Series



The figure is for reference only.

Figure 2-76 Rear panel

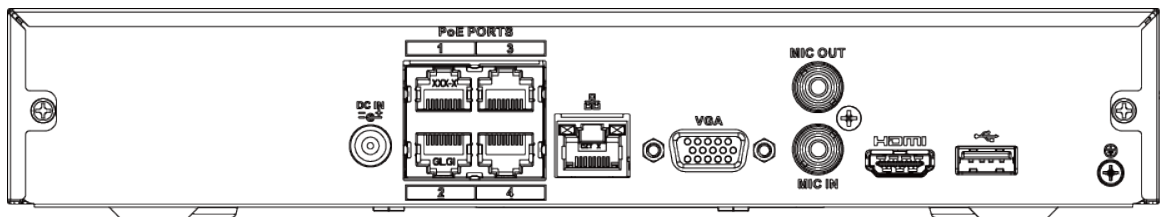





Table 2-34 Ports

Port Name	Connection	Function
	Power input port	Power socket.
	Network port	10/100 Mbps self-adaptive Ethernet port. Connect to the network cable.
	USB port	USB port. Connect to mouse, USB storage device and more.
HDMI	High Definition Media Interface	High definition audio and video signal output port. It transmits uncompressed high definition video and multiple-channel data to the HDMI port of the display device. HDMI version is 1.4.
VGA	VGA video output port	VGA video output port. Output analog video signal. It can connect to the monitor to view analog video.

Port Name	Connection	Function
MIC IN	Audio input port	Bidirectional talk input port. It is to receive the analog audio signal output from the devices such as microphone, pickup.
MIC OUT	Audio output port	Audio output port. It is to output the analog audio signal to the devices such as the sound box. <ul style="list-style-type: none"> • Bidirectional talk output. • Audio output on 1-window video monitor. • Audio output on 1-window video playback.
⊖	GND	Ground end.
PoE PORTS	PoE port	Built-in switch. Support PoE function. For PoE series product, you can use this port to provide power to the network camera.

2.2.21 NVR21HS-8P-I/NVR21HS-8P-I2 Series



The figure is for reference only.

Figure 2-77 Rear panel

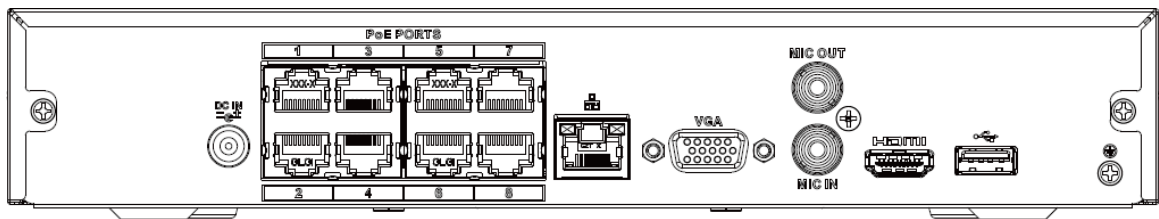

Table 2-35 Ports

Port Name	Connection	Function
⊖	GND	Ground end.
USB	USB port	USB port. Connect to mouse, USB storage device and more.
HDMI	High Definition Media Interface	High definition audio and video signal output port. It transmits uncompressed high definition video and multiple-channel data to the HDMI port of the display device. HDMI version is 1.4.
MIC IN	Audio input port	Bidirectional talk input port. It is to receive the analog audio signal output from the devices such as microphone, pickup.
MIC OUT	Audio output port	Audio output port. It is to output the analog audio signal to the devices such as the sound box. <ul style="list-style-type: none"> • Bidirectional talk output. • Audio output on 1-window video monitor. • Audio output on 1-window video playback.
VGA	VGA video output port	VGA video output port. Output analog video signal. It can connect to the monitor to view analog video.

Port Name	Connection	Function
	Network port	10/100 Mbps self-adaptive Ethernet port. Connect to the network cable.
PoE PORTS	PoE port	Built-in switch. Support PoE function. For PoE series product, you can use this port to provide power to the network camera.
	Power input port	Power socket.

2.2.22 NVR4208-8P-I Series



These figures are for reference only.

Figure 2-78 Rear panel

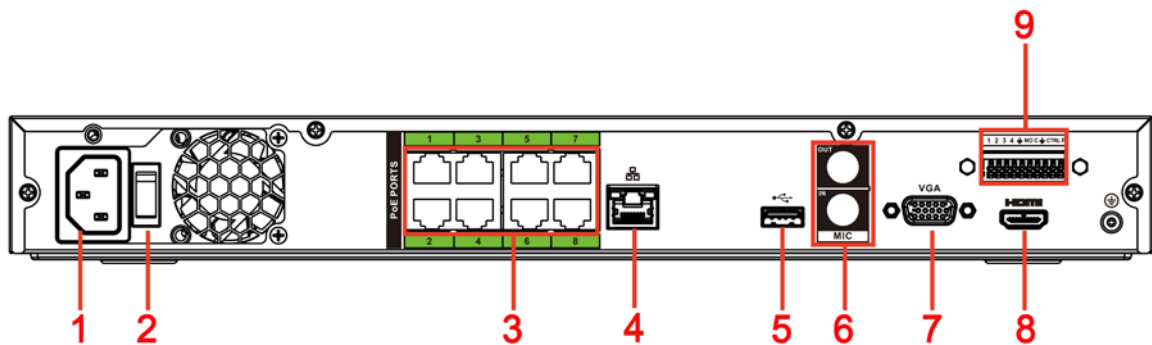



Table 2-36 Ports

No.	Port Name	Function
1	Power input port	Input power of 100-240 V and 50-60 Hz.
2	Power button	Turns on/off the NVR.
3	PoE port	Built-in switch. It can provide power for IPC. 8 PoE ports: 1-8 are ePoE ports (support 300m @ 100M. 800m @ 10M). The device supports 48 V, 100 W total power output under 55 °C, and 48 V, 130 W total power output under 45 °C.
4	Network port	10/100/1000 Mbps self-adaptive Ethernet port. Connect to the network cable.
5	USB port	USB 3.0 port. Connect to devices such as mouse, USB storage device and USB burner.
6	MIC IN	Bidirectional talk input port. It is to receive analog audio signal from devices such as microphone, sound pickup.
	MIC OUT	Audio output port. It is to output analog audio signal to devices such as sound box. <ul style="list-style-type: none"> • Bidirectional talk output. • Audio output on 1-window video monitor. • Audio output on 1-window video playback.

No.	Port Name	Function	
7	VGA port	VGA video output port. Output analog video signal. It can connect to the monitor to view analog video.	
8	HDMI port	High definition audio and video signal output port. It transmits uncompressed high definition video and multiple-channel audio data to displays with HDMI port.	
9	Alarm input port (1-4)	<ul style="list-style-type: none"> They receive signals from external alarm source. Alarm input includes two types; NO (normal open) and NC (normal close). When your alarm input device is using external power, make sure the device and the NVR have the same GND. 	
		GND. Alarm input ground port.	
	NO C	One NO activation output group. (On-off button).	
	CTRL	Controllable power supply output. Control the output of the on-off button alarm relay. It controls the alarm device with the presence or absence of voltage. It can also be used as power input for some alarm devices such as alarm detectors.	 The two ports serve as another group of alarm output ports.
	P	Power output port. It can provide power to some peripheral devices such as camera and alarm device. Make sure the power supply of peripheral device shall be below 1 A.	

2.2.23 NVR4216-I Series



The figure is for reference only.

Figure 2-79 Rear panel

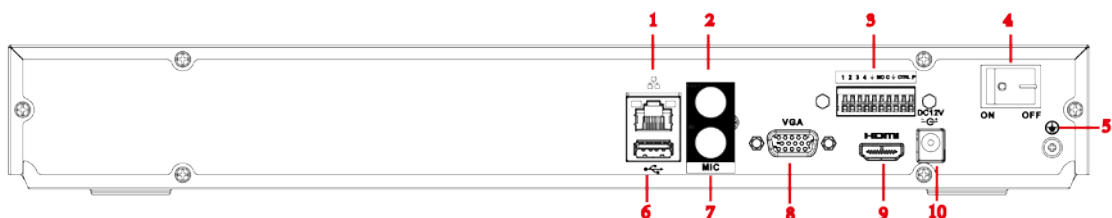





Table 2-37 Ports

No.	Port Name	Function
1	Network port	10/100/1000 Mbps self-adaptive Ethernet port. Connect to the network cable.

No.	Port Name	Function	
2	MIC OUT	Audio output port. It is to output analog audio signal to devices such as sound box. <ul style="list-style-type: none"> • Bidirectional talk output. • Audio output on 1-window video monitor. • Audio output on 1-window video playback. 	
3	Alarm input port (1-4)	<ul style="list-style-type: none"> • They receive signals from external alarm source. Alarm input includes two types; NO (normal open) and NC (normal close). • When your alarm input device is using external power, make sure the device and the NVR have the same GND. 	
		GND. Alarm input ground port.	
	NO C	One NO activation output group. (On-off button).	
	CTRL	Controllable power supply output. Control the output of the on-off button alarm relay. It controls the alarm device with the presence or absence of voltage. It can also be used as power input for some alarm devices such as alarm detectors.	 The two ports serve as another group of alarm output ports.
	P	Power output port. It can provide power to some peripheral devices such as camera and alarm device. Make sure the power supply of peripheral device shall be below 1 A.	
4	Power button	Turns on/off the NVR.	
5		GND.	
6	USB port	USB 3.0 port. Connect to devices such as mouse, USB storage device and USB burner.	
7	MIC IN	Bidirectional talk input port. It is to receive analog audio signal from devices such as microphone, sound pickup.	
8	VGA port	VGA video output port. Output analog video signal. It can connect to the monitor to view analog video.	
9	HDMI port	High definition audio and video signal output port. It transmits uncompressed high definition video and multiple-channel audio data to displays with HDMI port.	
10	Power input port	Input power of 100V-240V and 50Hz-60Hz.	

2.2.24 NVR58-I/NVR58-I/L/NVR48-I Series



- The figure takes NVR58-I/NVR58-I/L/NVR48-I series as examples.
- The figure is for reference only.

Figure 2-80 Rear panel

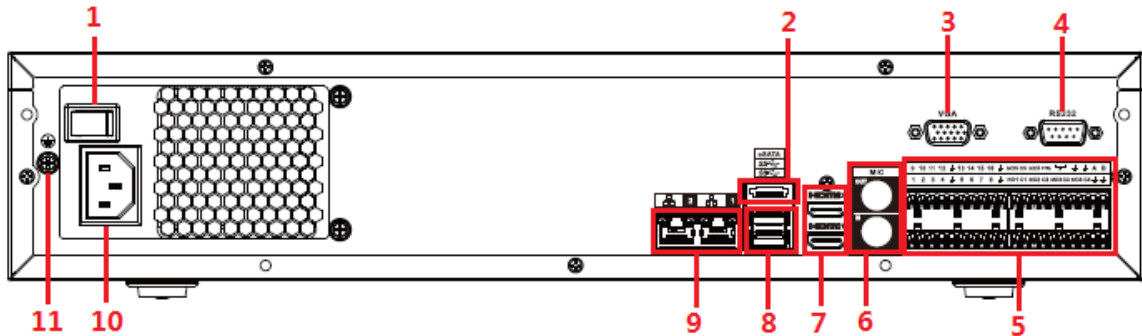

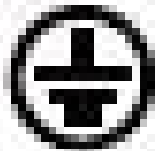

Table 2-38 Ports

No.	Port Name	Function
1	Power button	Turns on/off the NVR.
2	eSATA port	External SATA port. It can connect device with SATA port. You need to jump the HDD when there is peripherally connected HDD.
3	VGA port	VGA video output port. Output analog video signal. It can connect to the monitor to view analog video.
4	RS-232 port	It is for general COM debugging to configure IP address and transfer transparent COM data.
5	Alarm input port (1-16)	<ul style="list-style-type: none"> • There are four groups: 1-4, 5-8, 9-12 and 13-16. They receive signals from external alarm source. Alarm input includes two types; NO (normal open) and NC (normal close). • When your alarm input device is using external power, make sure the device and the NVR have the same GND.
	Alarm output port (NO1-NO5, C1-C5, NC5)	<ul style="list-style-type: none"> • Five groups of alarm output ports (Group 1: NO1-C1, Group 2: NO2-C2, Group 3: NO3-C3, Group 4: NO4-C4, Group 5: NO5, C5, NC5). Output alarm signal to the external alarm device. Make sure power supply is available for the external alarm device. • NO: Normal open alarm output port. • C: Alarm output public end. • NC: Normal close alarm output port.
		GND. Alarm input ground port.

No.	Port Name	Function
	RS-485 port (A, B)	<ul style="list-style-type: none"> • RS485_A port. Control cable A of the 485 device. It connects external devices such as speed dome and PTZ. • RS485_B port. Control cable B of the 485 device. It connects external devices such as speed dome and PTZ.
	CTRL	Controllable 12 V power output. It is to control the on-off alarm relay output. It can be used to control the device alarm output. At the same time, it can also be used as the power input source of some devices such as alarm detector.
		+12 V power output port. It can provide power to some peripheral devices such as camera and alarm device. Make sure the power supply of peripheral device shall be below 1 A.
6	MIC IN	Bidirectional talk input port. It is to receive analog audio signal from devices such as microphone, sound pickup.
	MIC OUT	Audio output port. It is to output analog audio signal to devices such as sound box. <ul style="list-style-type: none"> • Bidirectional talk output. • Audio output on 1-window video monitor. • Audio output on 1-window video playback.
7	HDMI port	High definition audio and video signal output port. It transmits uncompressed high definition video and multiple-channel audio data to displays with HDMI port. The two HDMI ports support 2-channel high definition HDMI output of different sources.
8	USB port	USB 3.0 port. Connect to devices such as mouse, USB storage device and USB burner.
9	Network port	10/100/1000 Mbps self-adaptive Ethernet port. Connect to the network cable.
10	Power input port	Input power of 100-240 V and 50Hz-60Hz.
11		GND.



The two ports serve as another group of alarm output ports.

2.2.25 NVR54-I/NVR54-I/L/NVR44-I Series





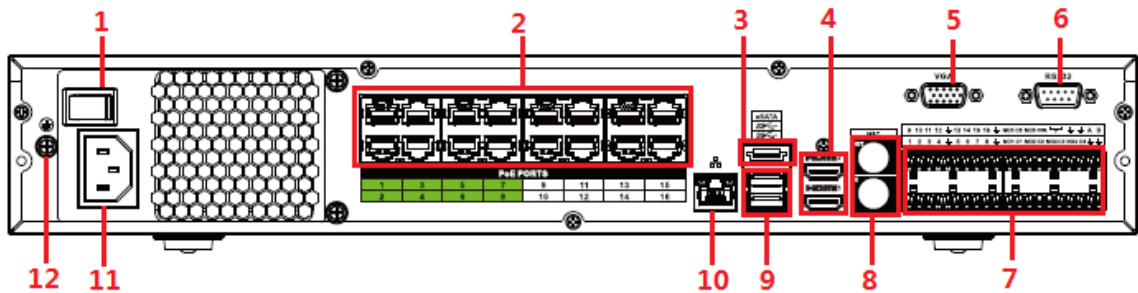

- The following figure takes NVR5432-16P-I and NVR5432-16P-I/L series as examples.
- The figure is for reference only.

Figure 2-81 Rear panel



No.	Port Name	Function
1	Power button	Turns on/off the NVR.
2	PoE port	Built-in switch. It can provide power for IPC. <ul style="list-style-type: none"> • 16 PoE ports: 1-8 are ePoE ports (support 300m @ 100M, 800m @ 10M). 9-16 are regular PoE ports. • Device with 16 PoEs supports 150 W total power.
3	eSATA port	External SATA port. It can connect device with SATA port. You need to jump the HDD when there is peripherally connected HDD.
4	HDMI port	High definition audio and video signal output port. It transmits uncompressed high definition video and multiple-channel audio data to displays with HDMI port. The two HDMI ports support 2-channel high definition HDMI output of different sources.
5	VGA port	VGA video output port. Output analog video signal. It can connect to the monitor to view analog video.
6	RS-232 port	It is for general COM debugging to configure IP address and transfer transparent COM data.
7	Alarm input port (1-16)	<ul style="list-style-type: none"> • There are four groups: 1-4, 5-8, 9-12 and 13-16. They receive signals from external alarm source. Alarm input includes two types; NO (normal open) and NC (normal close). • When your alarm input device is using external power, make sure the device and the NVR have the same GND.

No.	Port Name	Function
	Alarm output port (NO1-NO5, C1-C5, NC5)	<ul style="list-style-type: none"> Five groups of alarm output ports (Group 1: NO1-C1, Group 2: NO2-C2, Group 3: NO3-C3, Group 4: NO4-C4, Group 5: NO5, C5, NC5). Output alarm signal to the external alarm device. Make sure power supply is available for the external alarm device. NO: Normal open alarm output port. C: Alarm output public end. NC: Normal close alarm output port.
		GND. Alarm input ground port.
	RS-485 port (A, B)	<ul style="list-style-type: none"> RS485_A port. Control cable A of the 485 device. It connects external devices such as speed dome and PTZ. RS485_B port. Control cable B of the 485 device. It connects external devices such as speed dome and PTZ.
	CTRL	Controllable 12 V power output. It is to control the on-off alarm relay output. It can be used to control the device alarm output. At the same time, it can also be used as the power input source of some devices such as alarm detector.
		+12 V power output port. It can provide power to some peripheral devices such as camera and alarm device. Make sure the power supply of peripheral device shall be below 1 A.
		 <p>The two ports serve as another group of alarm output ports.</p>
8	MIC IN	Bidirectional talk input port. It is to receive analog audio signal from devices such as microphone, sound pickup.
	MIC OUT	Audio output port. It is to output analog audio signal to devices such as sound box. <ul style="list-style-type: none"> Bidirectional talk output. Audio output on 1-window video monitor. Audio output on 1-window video playback.
9	USB port	USB 3.0 port. Connect to devices such as mouse, USB storage device and USB burner.
10	Network port	10/100/1000 Mbps self-adaptive Ethernet port. Connect to the network cable.
11	Power input port	Input power of 100V-240V and 50Hz-60Hz.

No.	Port Name	Function
12		GND.

2.2.26

NVR52-16P-I/NVR52-16P-I/L/NVR52-8P-I/NVR52-8P-I/L/NVR42-16P-I Series



These figures are for reference only.

The NVR52-16P-I/NVR52-16P-I/L series rear panel is shown as below.

Figure 2-82 Rear panel

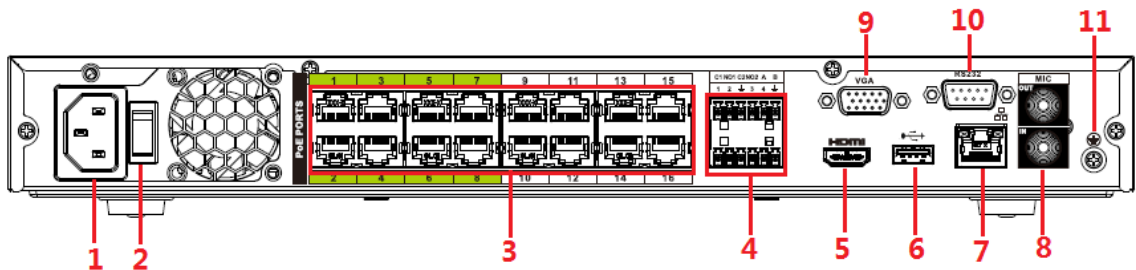

The NVR52-8P-I/NVR52-8P-I/L series rear panel is shown as below.

Figure 2-83 Rear panel

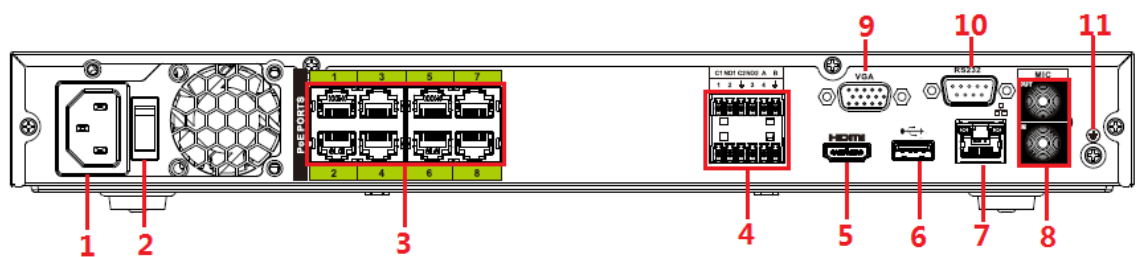

The NVR4216-16P-I series rear panel is shown as below.

Figure 2-84 Rear panel

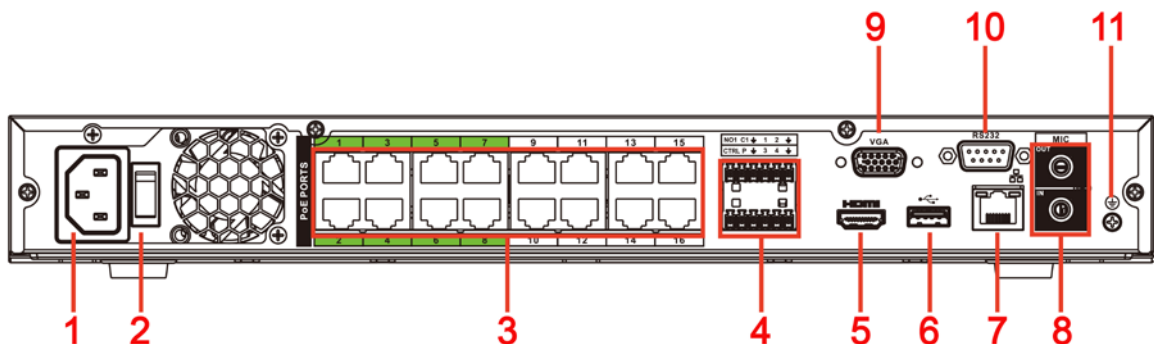

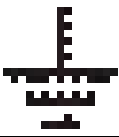

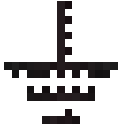

Table 2-39 Rear panel description

No.	Port Name	Function	
1	Power input port	Input power of 100-240 V and 50-60 Hz.	
2	Power button	Turns on/off the NVR.	
3	PoE port	Built-in switch. It can provide power for IPC. 16 PoE ports: 1-8 are ePoE ports (support 300m @ 100M. 800m @ 10M). 9-16 are regular PoE ports. The device supports 150 W total power. 8 PoE ports: 1-8 are ePoE ports (support 300m @ 100M. 800m @ 10M). The device supports 48 V, 120 W total power.	
4	Alarm input/output of NVR52-16P-I/NVR52-16P-I/L and NVR52-8P-I/NVR52-8P-I/L	Alarm input port (1-4)	<ul style="list-style-type: none"> They receive signals from external alarm source. Alarm input includes two types; NO (normal open) and NC (normal close). When your alarm input device is using external power, make sure the device and the NVR have the same GND.
		Alarm output port (NO1-NO2, C1-C2)	<ul style="list-style-type: none"> Two groups of alarm output ports (Group 1: NO1-C1, Group 2: NO2-C2). Output alarm signal to the external alarm device. Make sure power supply is available for the external alarm device. NO: Normal open alarm output port. C: Alarm output public end.
			GND. Alarm input ground port.
		RS-485 port (A, B)	<ul style="list-style-type: none"> RS485_A port. Control cable A of the 485 device. It connects external devices such as speed dome and PTZ. RS485_B port. Control cable B of the 485 device. It connects external devices such as speed dome and PTZ.
	Alarm input/output of NVR4216-16P-I	Alarm input port (1-4)	<ul style="list-style-type: none"> They receive signals from external alarm source. Alarm input includes two types; NO (normal open) and NC (normal close). When your alarm input device is using external power, make sure the device and the NVR have the same GND.
		Alarm output port (NO1, C1)	<ul style="list-style-type: none"> One group of alarm output ports (Group 1: NO1-C1). Output alarm signal to the external alarm device. Make sure power supply is available for the external alarm device. NO: Normal open alarm output port. C: Alarm output public end.

No.	Port Name	Function	
			GND. Alarm input ground port.
		CTRL	Controllable 12 V power output. It is to control the on-off alarm relay output. It can be used to control the device alarm output. At the same time, it can also be used as the power input source of some devices such as alarm detector.
		P	+12 V power output port. It can provide power to some peripheral devices such as camera and alarm device. Make sure the power supply of peripheral device shall be below 1 A.
			 The two ports serve as another group of alarm output ports.
5	HDMI port	High definition audio and video signal output port. It transmits uncompressed high definition video and multiple-channel audio data to displays with HDMI port.	
6	USB port	USB 3.0 port. Connect to devices such as mouse, USB storage device and USB burner.	
7	Network port	10/100/1000 Mbps self-adaptive Ethernet port. Connect to the network cable.	
8	MIC IN	Bidirectional talk input port. It is to receive analog audio signal from devices such as microphone, sound pickup.	
	MIC OUT	Audio output port. It is to output analog audio signal to devices such as sound box. <ul style="list-style-type: none"> • Bidirectional talk output. • Audio output on 1-window video monitor. • Audio output on 1-window video playback. 	
9	VGA port	VGA video output port. Output analog video signal. It can connect to the monitor to view analog video.	
10	RS-232 port	It is for general COM debugging to configure IP address and transfer transparent COM data.	
11		GND.	

2.2.27 NVR608-4KS2/NVR608H-XI/NVR608RH-XI Series

The NVR608-32-4KS2 series rear panel is shown as below.

Figure 2-85 Rear panel (1)

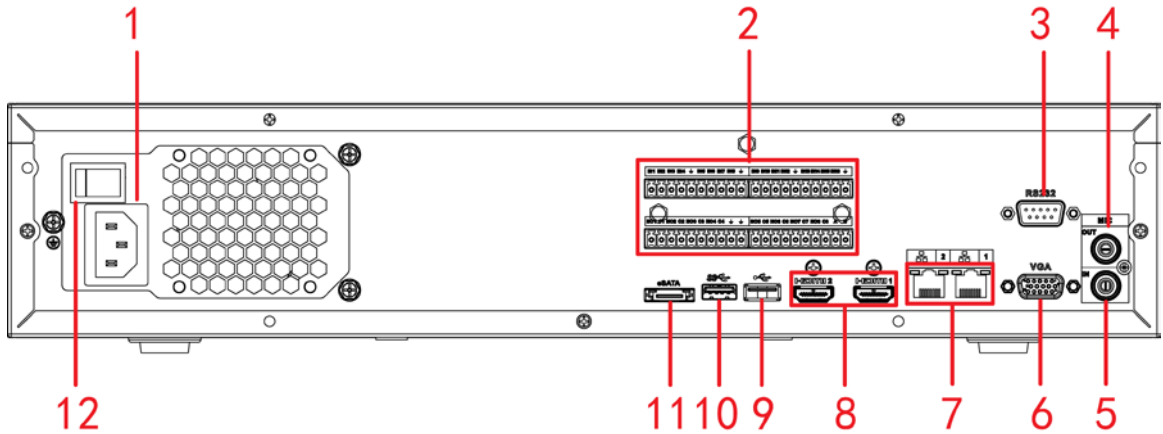

The NVR608-64-4KS2/NVR608-128-4KS2/NVR608H-32-XI/NVR608H-64-XI/NVR608H-128-XI series rear panel is shown as below.

Figure 2-86 Rear panel (2)

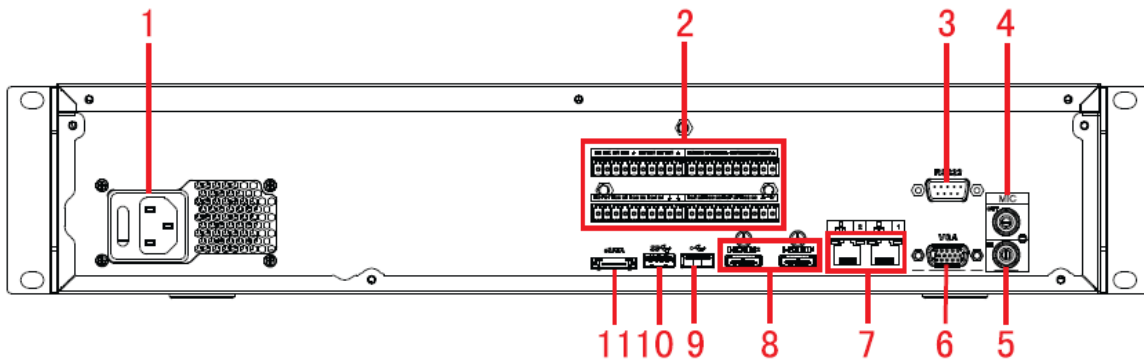
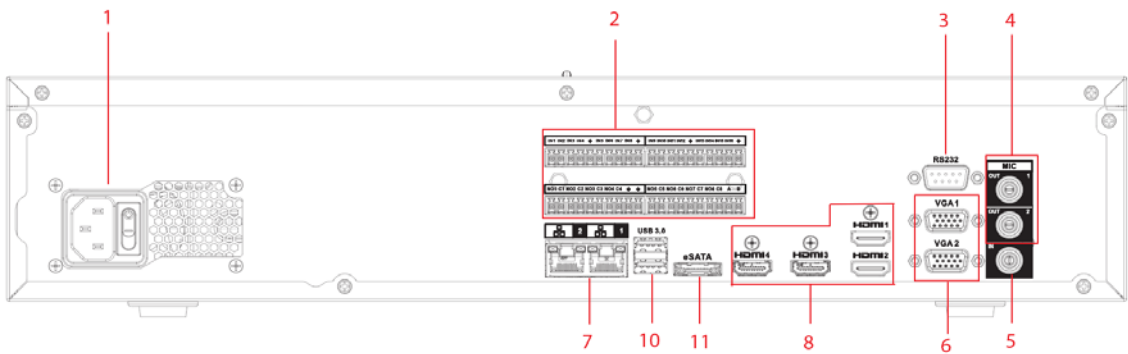

Figure 2-87 Rear panel (3)



The NVR608RH-32-XI/NVR608RH-64-XI/NVR608RH-128-XI front panel is shown as below.

Figure 2-88 Rear panel (4)

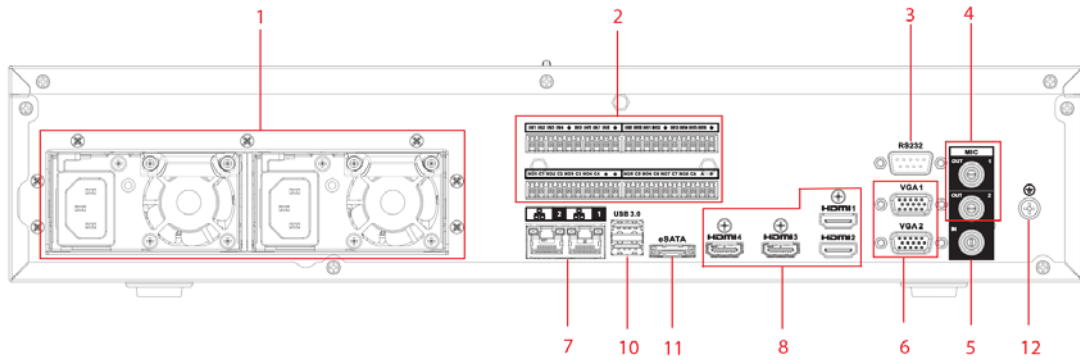

Table 2-40 Ports description

No.	Function	No.	Function
1	Power socket.	2	Alarm input/alarm output/RS-485 port
3	RS-232 port	4	Audio output
5	Audio input	6	VGA port
7	Network port	8	HDMI port
9	<ul style="list-style-type: none"> NVR608-4K: USB 2.0 port NVR608-4KS2: USB 3.0 port 	10	USB 3.0 port
11	eSATA port	12	Ground

2.2.28 NVR616-4KS2 Series

The general series rear panel of NVR616-4KS2 is shown as below.

Figure 2-89 Rear panel

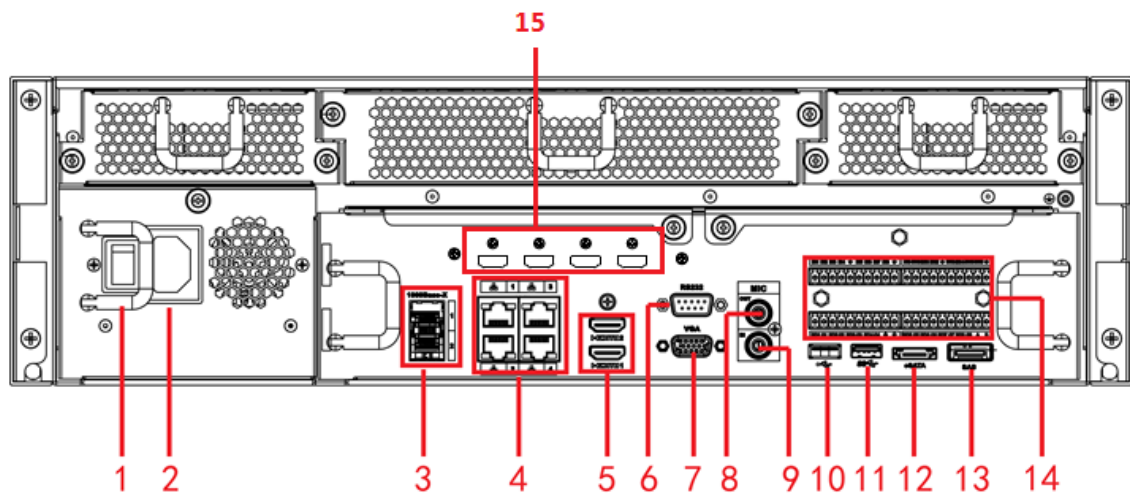

The redundant power series rear panel of NVR616-4KS2 is shown as below.

Figure 2-90 Rear panel

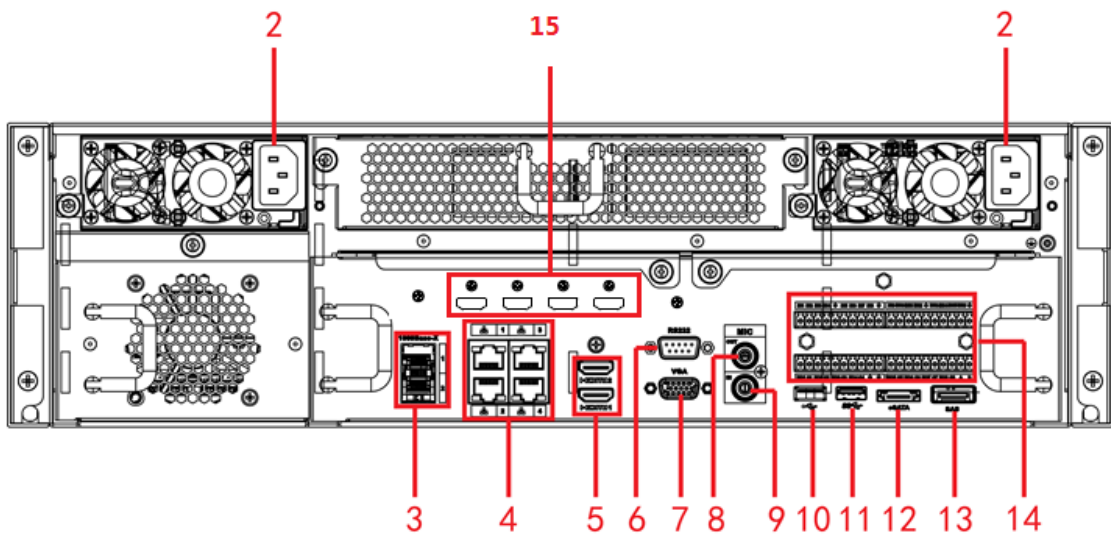



Table 2-41 Ports

No.	Name	No.	Name
1	Power on-off button	2	Power socket.
3	1000M fiber port	4	Network port
5	HDMI port	6	RS-232 port
7	Video VGA output	8	Audio output
9	Audio input	10	USB 3.0 port
11	USB 3.0 port	12	eSATA port
13	SAS extension port	14	Alarm input/output/RS-485 port
15	HDMI port  High-definition decoding card is not installed in standard hardware configuration, you can purchase as needed.	—	—

2.2.29 NVR11HS-W-S2-CE/NVR11HS-W-S2-FCC Series

Figure 2-91 Rear panel

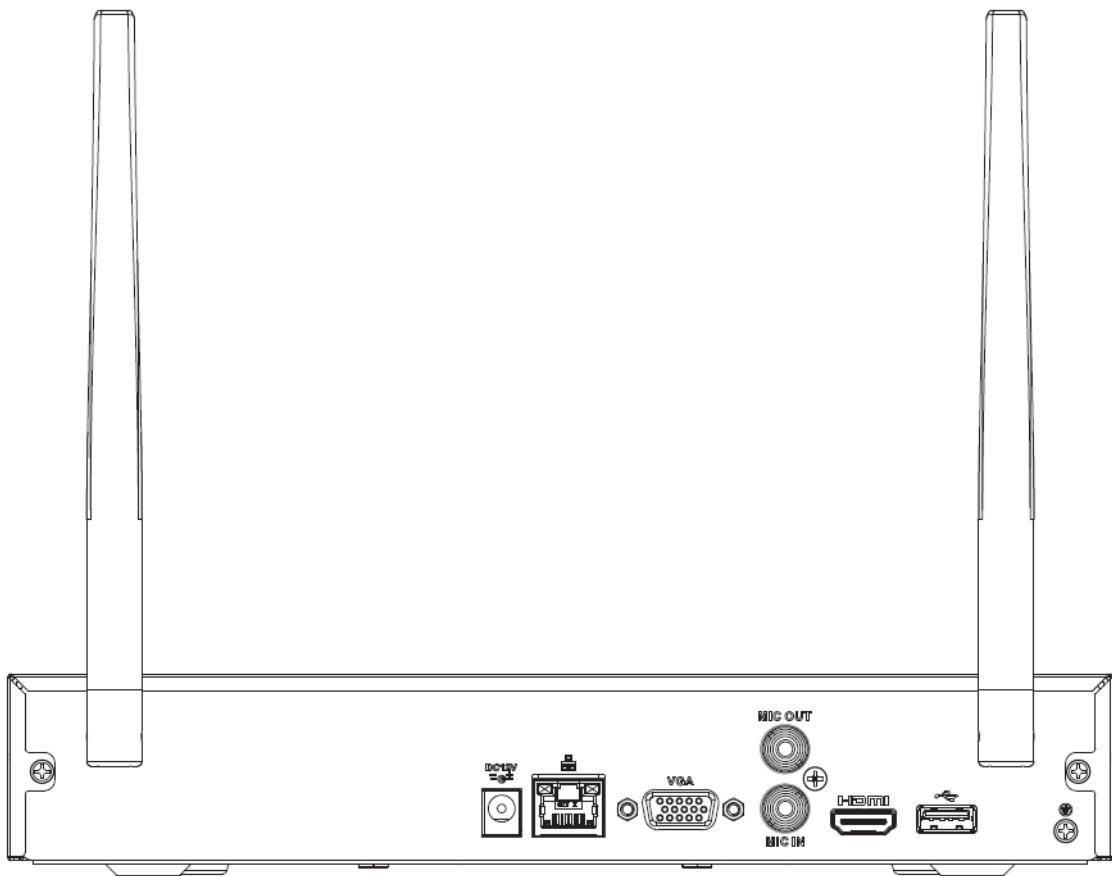

Table 2-42 Ports

Icon	Name	Function
	USB 2.0 port	USB 2.0 port. Connect to mouse, USB storage device, USB burner and more.
	Network port	10/100 Mbps self-adaptive Ethernet port. Connect to the network cable.
HDMI	High Definition Media Interface	High definition audio and video signal output port. It transmits uncompressed high definition video and multiple-channel data to the HDMI port of the display device. HDMI version is 1.4.
VGA	VGA video output port	VGA video output port. Output analog video signal. It can connect to the monitor to view analog video.
	Power input port	Input 12 VDC/2 A.
MIC IN	Audio input port	Bidirectional talk input port. It is to receive the analog audio signal output from the devices such as microphone, pickup.

Icon	Name	Function
MIC OUT	Audio output port	Audio output port. It is to output the analog audio signal to the devices such as the sound box. <ul style="list-style-type: none"> • Bidirectional talk output. • Audio output on 1-window video monitor. • Audio output on 1-window video playback.
⊕	GND	Ground end.

2.2.30 NVR54-EI/NVR54-16P-EI/NVR58-EI/NVR58-16P-EI Series

The NVR54-EI series rear panel is shown as below.

Figure 2-92 Rear panel

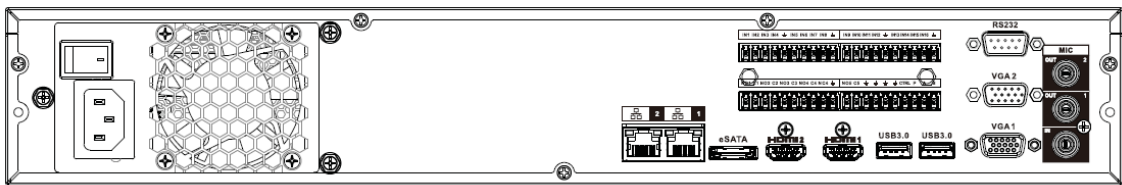

The NVR58-EI series rear panel is shown as below.

Figure 2-93 Rear panel

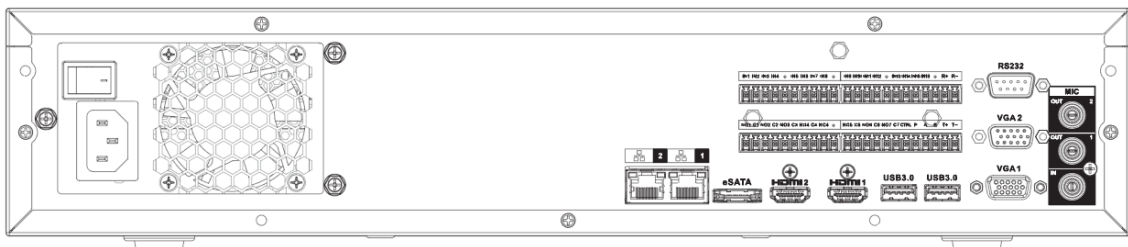

The NVR54-16P-EI series rear panel is shown as below.

Figure 2-94 Rear panel

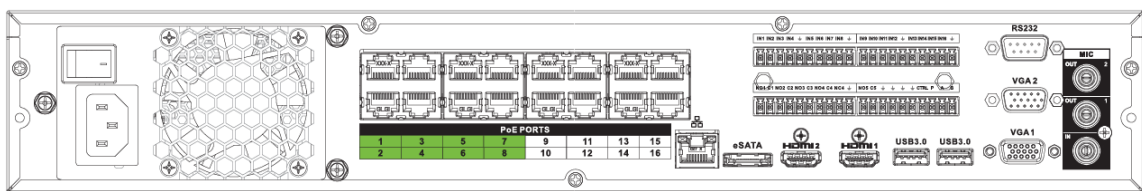

The NVR58-16P-EI series rear panel is shown as below.

Figure 2-95 Rear panel

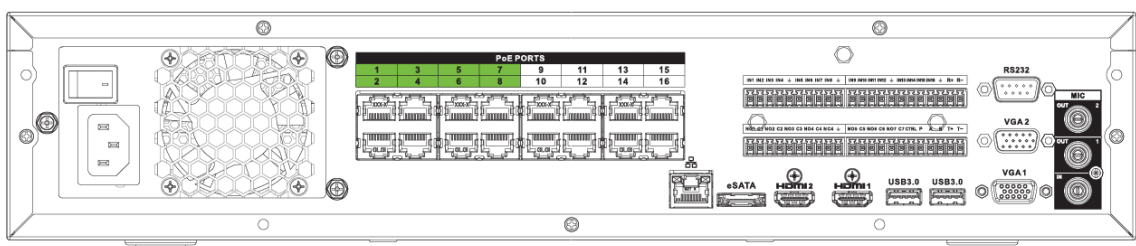







Table 2-43 Rear panel description

Icon	Name	Function
	Power switch	Power on-off button
	Power input port	Input 100–240 VAC.
	Network port	10/100/1000 Mbps self-adaptive Ethernet port. Connect to the network cable.
eSATA	eSATA port	External SATA port. It can connect to the device of the SATA port. Please jump the HDD when there is peripheral connected HDD.
USB 3.0	USB port	USB port. Connect to mouse, USB storage device, USB burner and more.
HDMI	High Definition Media Interface	High definition audio and video signal output port. It transmits uncompressed high definition video and multiple-channel data to the HDMI port of the display device. HDMI version is 1.4b.
MIC IN	Audio input port	Bidirectional talk input port. It is to receive the analog audio signal output from the devices such as microphone, pickup.
MIC OUT	Audio output port	Audio output port. It is to output the analog audio signal to the devices such as the sound box. <ul style="list-style-type: none"> • Bidirectional talk output. • Audio output on 1-window video monitor. • Audio output on 1-window video playback.
1–16	Alarm input port 1–16	<ul style="list-style-type: none"> • There are four groups. The first group is from port 1 to port 4, the second group is from port 5 to port 8, the third group is from 9 to 12, and the fourth group is from 13 to 16. They are to receive the signal from the external alarm source. There are two types; NO (normal open)/NC (normal close). • When your alarm input device is using external power, please make sure the device and the NVR have the same ground.
	Ground	Alarm input ground end.
NO1–NO5	Alarm output port 1–5	<ul style="list-style-type: none"> • 5 groups of alarm output ports. (Group 1: port NO1–C1, Group 2:port NO2–C2, Group 3:
C1–C5		

Icon	Name	Function	
NC5		port NO3–C3, Group 4: port NO4–C4, Group 5: port NO5, C5, NC5). Output alarm signal to the alarm device. Please make sure there is power to the external alarm device. <ul style="list-style-type: none"> • NO: Normal open alarm output port. • C: Alarm output public end. • NC: Normal close alarm output port. 	
A	RS-485 communication port	RS485_A port. It is the cable A. You can connect to the control devices such as speed dome PTZ.	
B		RS485_B. It is the cable B. You can connect to the control devices such as speed dome PTZ.	
CTRL (CTRL 12 V)	—	Controller 12 V power output. It is to control the on-off alarm relay output. It can be used to control the device alarm output. At the same time, it can also be used as the power input source of some devices such as the alarm detector.	 The two ports serve as another group of alarm output ports.
P (+12 V)	—	+12 V power output port. It can provide the power to some peripheral devices such as the camera or the alarm device. Please note the supplying power shall be below 1 A.	
RS-232	RS-232 debug COM	It is for general COM debug to configure IP address or transfer transparent COM data.	
VGA	VGA video output port	VGA video output port. Output analog video signal. It can connect to the monitor to view analog video.	
PoE PORTS	—	Built-in Switch. Support PoE or ePoE function. For ePoE series product, port 1 to port 8 are the ePoE ports. ePoE port supports 300 meters@100Mbps, 800 meters@10Mbps. Port 9 to port 16 are general PoE ports. The 16 PoE series supports total 150W.	

2.2.31 NVR50-EI Series

The NVR50-EI series rear panel is shown as below.

Figure 2-96 Rear panel

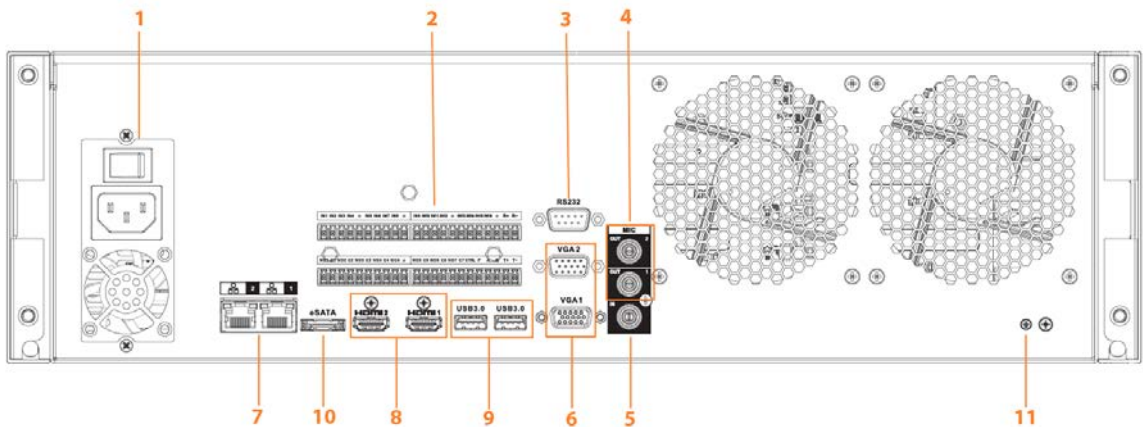

Table 2-44 Ports description

No.	Function	No.	Function
1	Power socket.	2	Alarm input/alarm output/RS-485 port
3	RS-232 port	4	Audio output
5	Audio input	6	VGA port
7	Network port	8	HDMI port
9	USB 3.0 port	10	eSATA port
12	Ground	—	—

2.3 Alarm Connection

2.3.1 Alarm Port

The alarm port is shown as below. The following figure is for reference only.

Figure 2-97 Alarm port

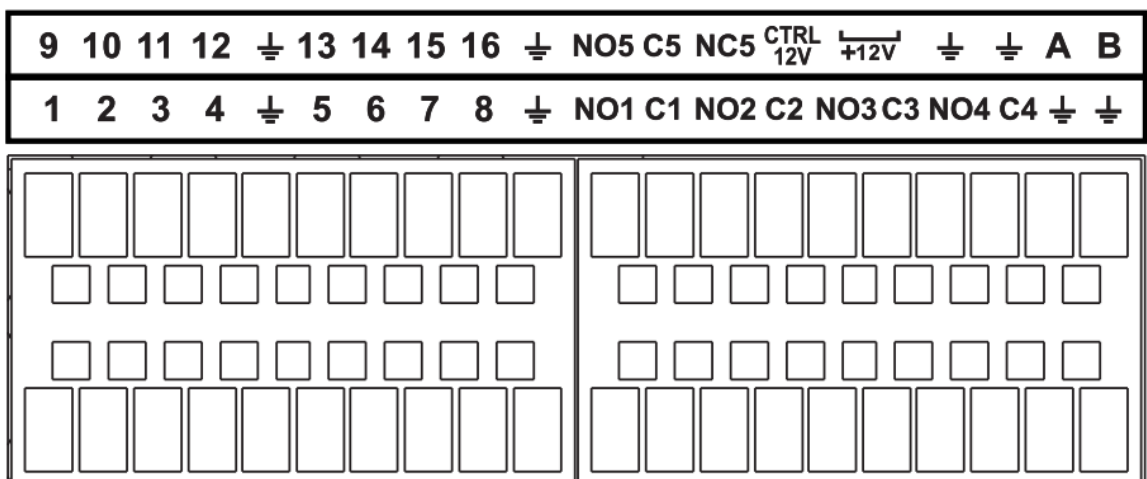

Table 2-45 Alarm port description

Icon	Function
1-16	ALARM1-ALARM16. The alarm becomes activated in the low level.
NO1 C1, NO2 C2, NO3 C3, NO4 C4	Four NO activation output groups. (On-off button).
NO5 C5 NC5	One NO/NC activation output group. (On-off button).
CTRL (CTRL 12 V)	Control power output. Disable power output when alarm is canceled. Current is 500 mA.
P (+12 V)	Rated current output. Current is 500 mA.
	GND.
A/B	485 communication port. They are used to control devices such as PTZ. Please parallel connect 120 TΩ between A/B cables if there are too many PTZ decoders.



- Different models support different alarm input ports. Please see the specifications sheet for detailed information.
- Slight difference might be found on the alarm port layout.

2.3.2 Alarm Input Port

Connect the positive end (+) of the alarm input device to the alarm input port (ALARM IN 1-16) of

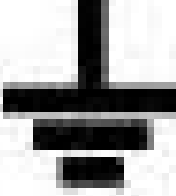
the NVR. Connect the negative end (-) of the alarm input device to the ground end ()

of the NVR.

Figure 2-98 Alarm input port (1)

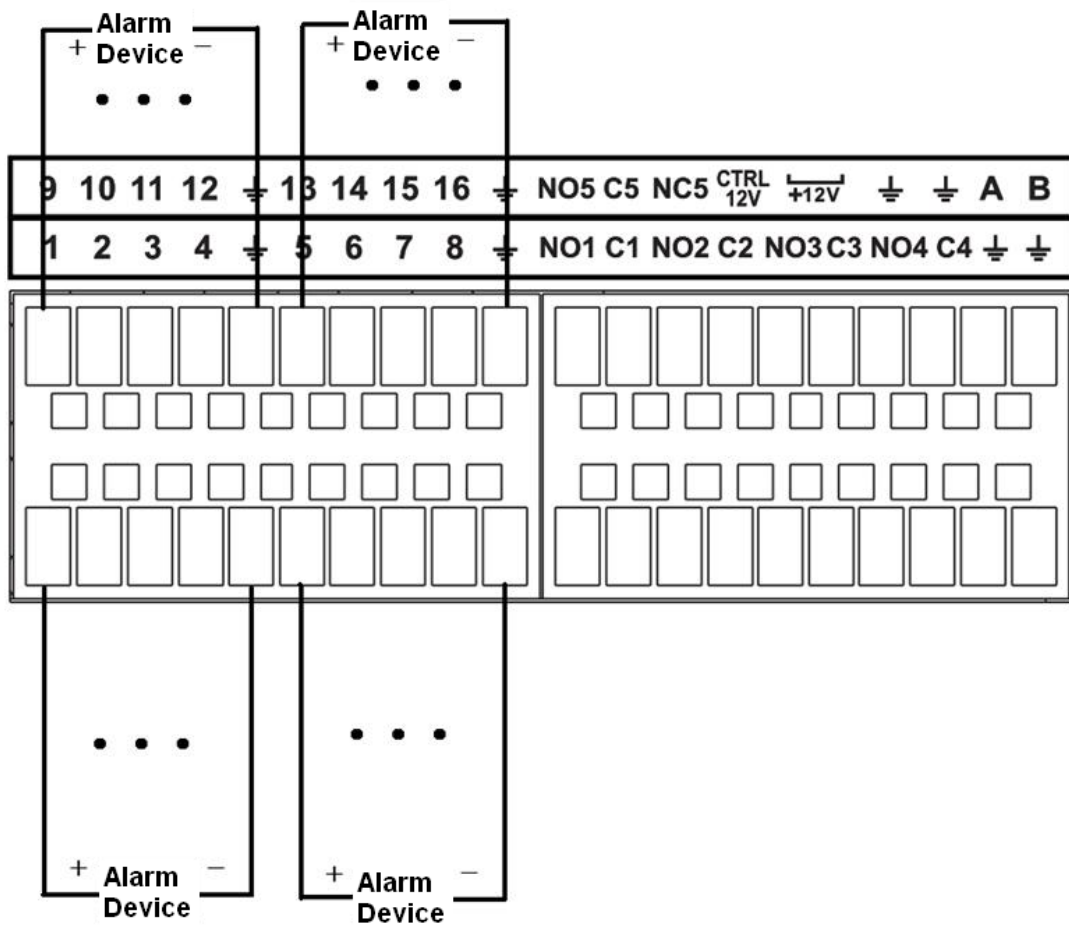
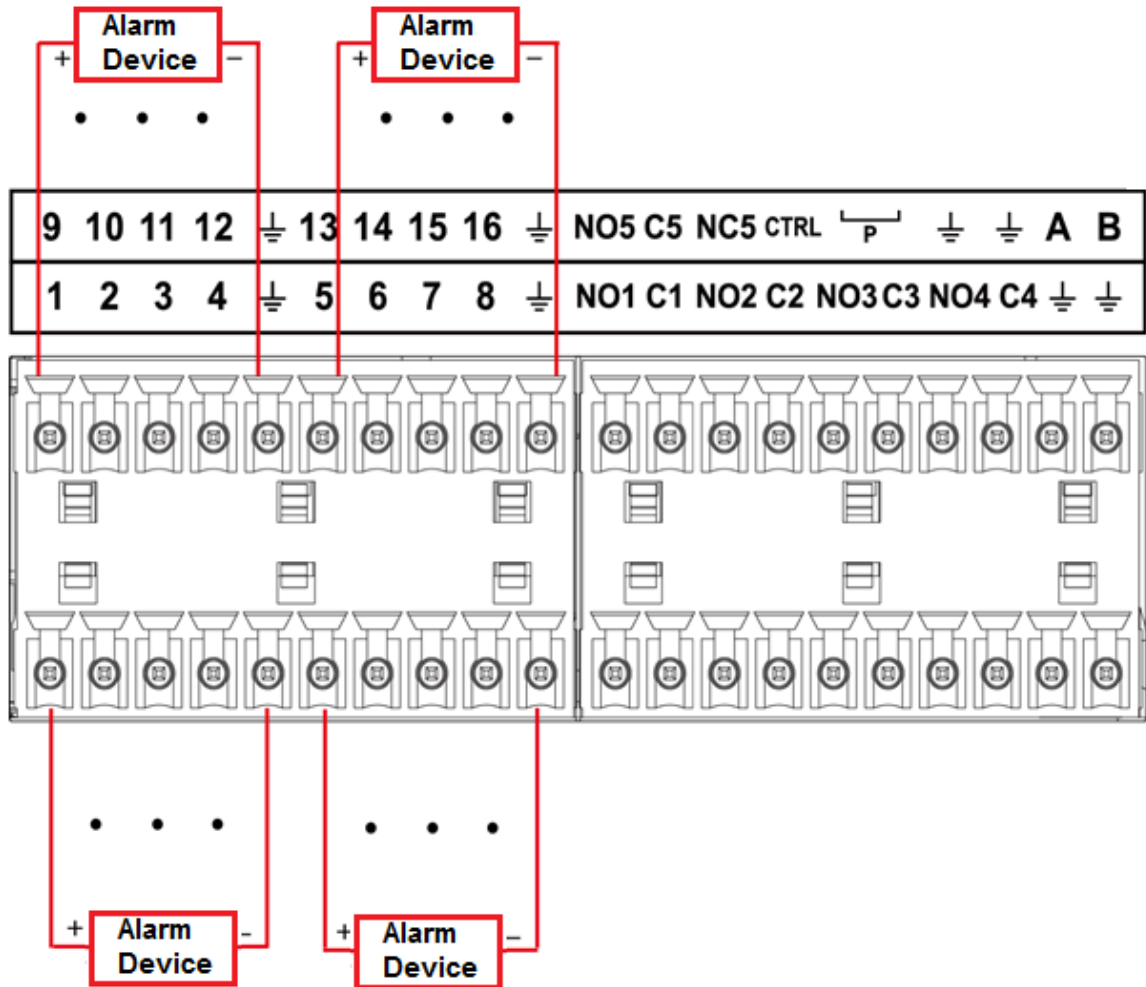
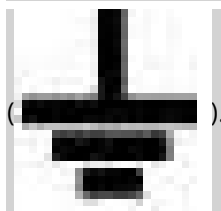

Figure 2-99 Alarm input port (2)



- There are two alarm input types: NO/NC.
- When connect the ground port of the alarm device to the NVR, you can use any of the GND ports



- Connect the NC port of the alarm device to the alarm input port (ALARM) of the NVR.
- When there is peripheral power supplying for the alarm device, please make sure it is earthed with the NVR.

2.3.3 Alarm Output Port

- There is peripheral power supplying for the external alarm device.
- In case overload might result in NVR damage, please see the following relay specifications for detailed information.
- A/B cable of the RS-485 is for the A/B cable connection of the speed PTZ.

2.3.4 Alarm Relay Specifications

Table 2-46 Alarm relay specifications

Model: JRC-27F		
Material of the touch	Silver	
Rating (Resistance Load)	Rated switch capacity	30 VDC 2 A, 125 VAC 1 A
	Maximum switch power	125 VAC, 160 W
	Maximum switch voltage	250 VAC, 220 VDC
	Maximum switch current	1 A
Insulation	Between touches with same polarity	1000 VAC 1 minute
	Between touches with different polarity	1000 VAC 1 minute
	Between touch and winding	1000 VAC 1 minute
Surge voltage	Between touches with same polarity	1500 V (10×160 μs)
Length of open time	3 ms max	
Length of close time	3 ms max	
Longevity	Mechanical	50 × 10 ⁶ MIN (3 Hz)
	Electrical	200 × 10 ³ MIN (0.5 Hz)
Temperature	-40 °C to +70 °C	

2.4 Two-way Talk

2.4.1 Device-end to PC-end

Procedure

- Step 1 Connect the speaker or the pickup to the first audio input port on the device rear panel.
- Step 2 Connect the earphone or the sound box to the audio output port in the PC.
- Step 3 Log in to the web and then enable the corresponding channel real-time monitor.
- Step 4 Enable two-way talk.

Figure 2-100 Enable two-way talk

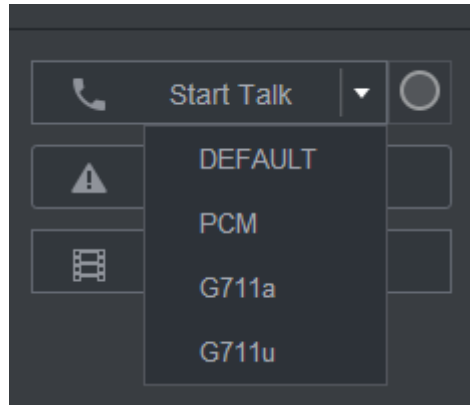

Step 5 At the device end, speak by the speaker or the pickup, and then you can get the audio from the earphone or sound box at the PC end.

Figure 2-101 Device to PC

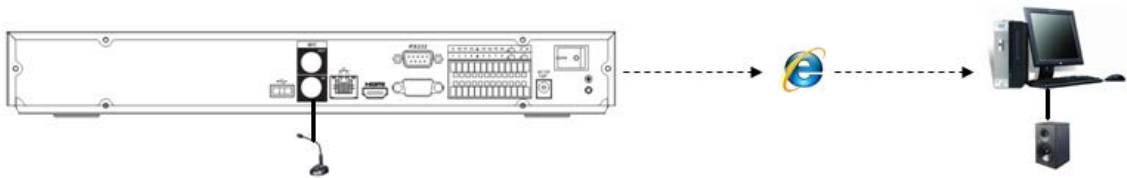

2.4.2 PC-end to the Device-end

Device Connection

1. Connect the speaker or the pickup to the audio output port in the PC.
2. Connect the earphone or the sound box to the first audio input port in the device rear panel.
3. Log in to the web and then enable the corresponding channel real-time monitor.
4. Enable bidirectional talk. See Figure 2-100.

Listening Operation

At the PC-end, speak by the speaker or the pickup, and then you can get the audio from the earphone or sound box at the device-end.

Figure 2-102 PC to device

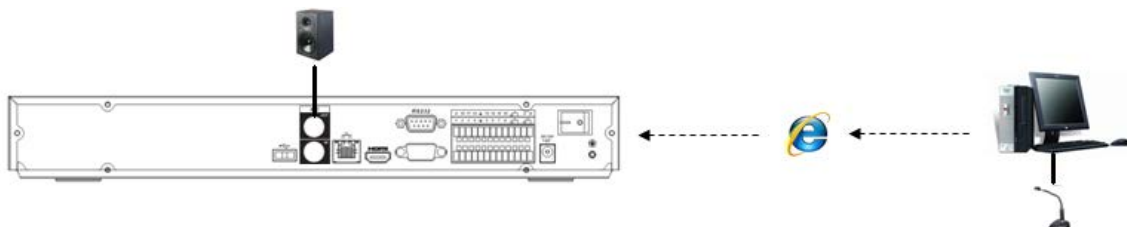

3 Device Installation



All the installation and operations here should conform to your local electric safety rules.

3.1 Device Installation Diagram

Please see the following diagram to install the NVR.

Figure 3-1 Installation flowchart

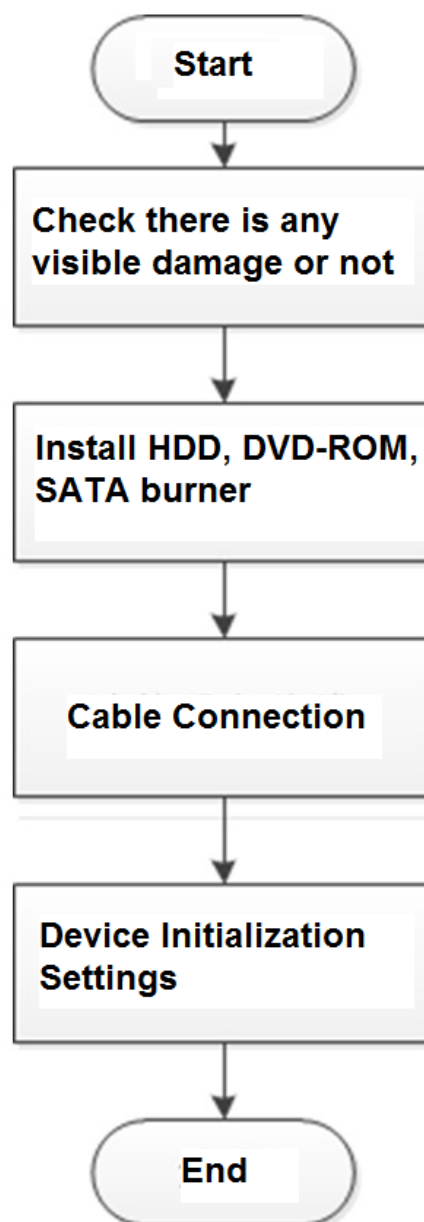

3.2 Checking Unpacked NVR

When you receive the NVR, check against the following checklist. If any of the items are missing or damaged, contact the local retailer or after-sales service immediately.

Table 3-1 Checklist

Sequence	Item	Description	
1	Overall packaging	Appearance	No obvious damage.
		Package	Not distorted or broken.
		Accessories	Nothing missing.
2	The Device	Appearance	No obvious damage.
		Model	The model description is consistent with the contract.
		Label	Not torn up.  Keep the label well. You need to provide the serial number on the label when calling the after-sales service.

3.3 HDD Installation

For the first time installation, make sure whether the HDD has been installed or not. We recommend to use HDD of enterprise level or surveillance level. It is not recommended to use PC HDD.



- Shut off the power before you replace the HDD.
- Use the dedicated SATA HDD for monitoring recommended by the HDD manufacturer.
- You can see the Appendix for HDD space information and recommended HDD brand.

3.3.1

NVR41-4KS2/NVR41-P-4KS2/NVR41-8P-4KS2/NVR41-4KS2/L/NVR41-P-4KS2/L/NVR41-8P-4KS2/L/NVR21-4KS2/NVR21-P-4KS2/NVR21-8P-4KS2/NVR21-W-4KS2/NVR21-I/NVR21-I2/NVR21-P-I/NVR21-P-I2/NVR21-8P-I/NVR21-8P-I2/NVR21-S3/NVR21-P-S3/NVR21-8P-S3

Background Information



Connect cable and then secure the HDD on the NVR if it is not convenient to connect the HDD data cable and power cable at first.

Procedure

- Step 1** Loosen the screws of the bottom of the chassis.

Figure 3-2 Loosen screws

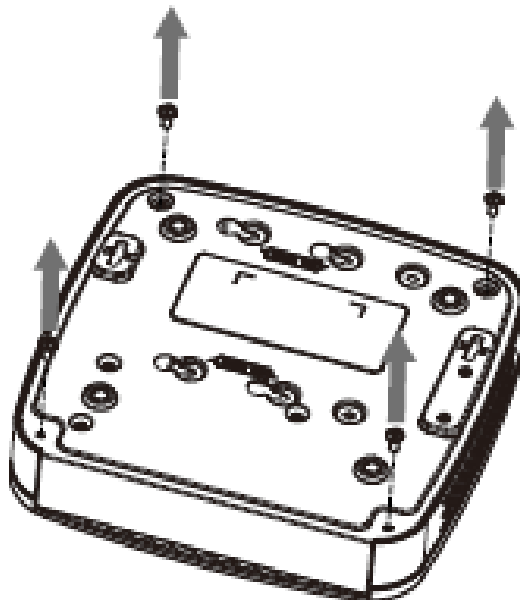

- Step 2** Place the HDD in accordance with the four holes in the bottom.

Figure 3-3 Align HDD



Step 3 Turn the device upside down and then secure the screws firmly.

Figure 3-4 Secure screws

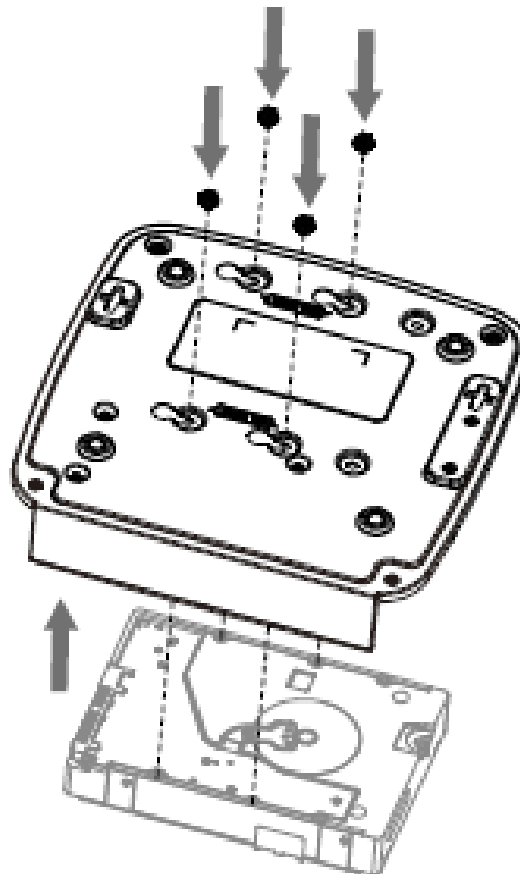

Step 4 Connect the HDD cable and power cable to the HDD and the mainboard respectively.

Figure 3-5 Connect cables

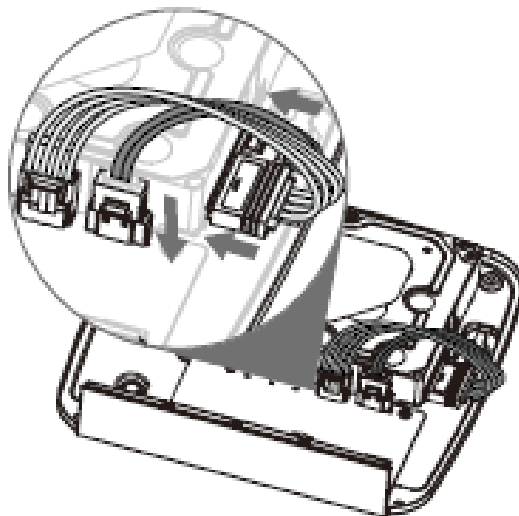

Step 5 Put the cover back and then fix the screws of the rear panel. The installation is complete.

Figure 3-6 Put back the cover

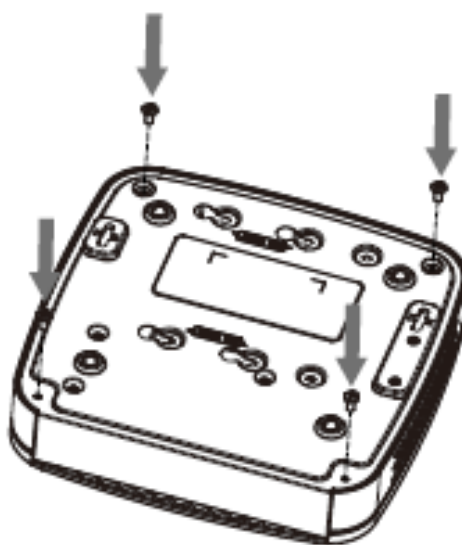

3.3.2

NVR41HS-4KS2/NVR41HS-P-4KS2/NVR41HS-8P-4KS2/NVR41HS-4KS2/L/NVR41HS-P-4KS2/L/NVR41HS-8P-4KS2/L/NVR21HS-4KS2/NVR21HS-P-4KS2/NVR21HS-8P-4KS2/NVR21HS-W-4KS2/NVR11HS-S3H/NVR11HS-P-S3H/NVR11HS-8P-S3H/NVR21HS-I/NVR21HS-I2/NVR21HS-P-I/NVR21HS-P-I2/NVR21HS-8P-I/NVR21HS-8P-I2/NVR21HS-S3/

NVR21HS-P-S3/NVR21HS-8P-S3/NVR11HS-W-S2-CE/NVR11HS-W-S2 -FCC Series

Procedure

Step 1 Loosen the screws of the upper cover and side panel.

Figure 3-7 Loosen screws

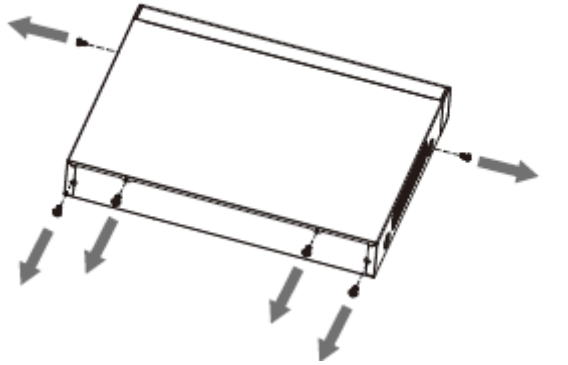

Step 2 Remove the cover in the direction of the arrow as shown in the figure below.

Figure 3-8 Remove cover

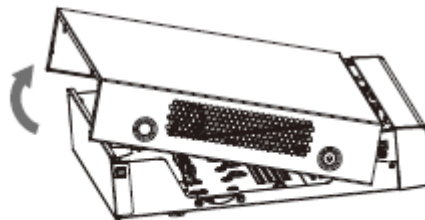

Step 3 Turn over the device, and align the HDD to the four holes of bottom panel, and then fix the HDD with screws.

Figure 3-9 Align HDD

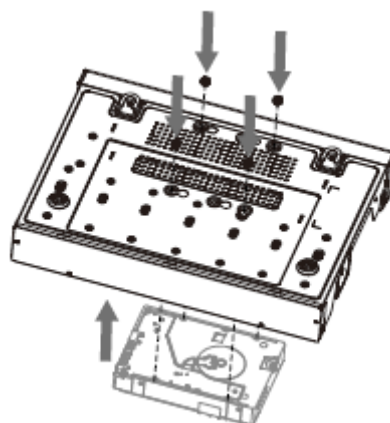

Step 4 Connect HDD to the device using data cable and power cable.

Figure 3-10 Connect cables

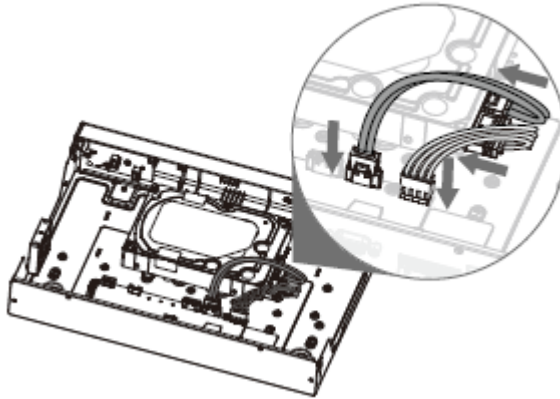

Step 5 Put the cover in accordance with the clip and then fix the screws on the rear panel and side panel.

Figure 3-11 Put cover back

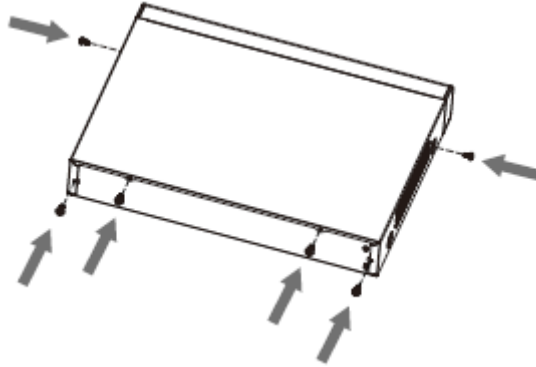

3.3.3

NVR22-8P-S2/NVR42-4KS2/NVR42-P-4KS2/NVR42-8P-4KS2/NVR42-16P-4KS2/NVR42-4KS2/L/NVR42-P-4KS2/L/NVR42-8P-4KS2/L/NVR42-2-16P-4KS2/L/NVR52-4KS2/NVR52-8P-4KS2/NVR52-16P-4KS2/NVR52-24P-4KS2/NVR22-4KS2/NVR22-P-4KS2/NVR22-8P-4KS2/NVR52-8P-4KS2E/NVR22-I/NVR22-I2/NVR22-P-I/NVR22-P-I2/NVR22-8P-I/NVR22-8P-I2/NVR22-16P-I/NVR22-16P-I2/NVR42-I/NVR42-8P-I/NVR42-16P-I/NVR52-16P-I/NVR52-16P-I/L/NVR52-8P-I/NVR52-8P-I/L Series

Background Information



Different models have different numbers of HDDs.

Procedure

Step 1 Remove the four fixing screws on the rear panel.

Figure 3-12 Remove screws

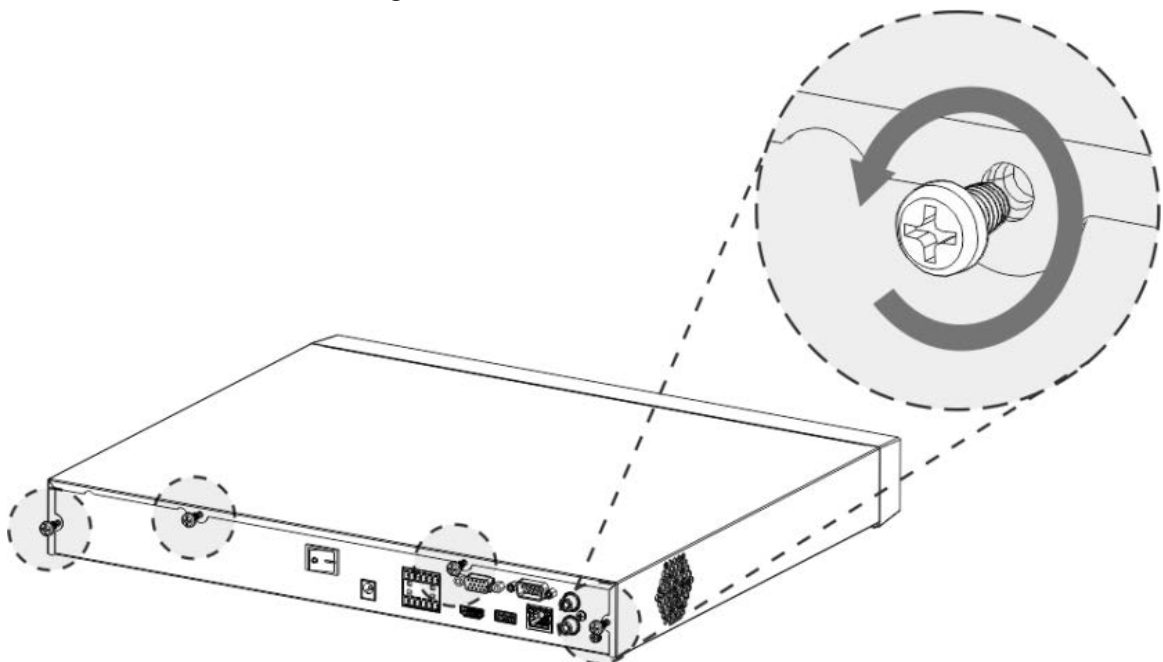

Step 2 Remove the case cover along the direction shown in the following arrow.

Figure 3-13 Remove cover

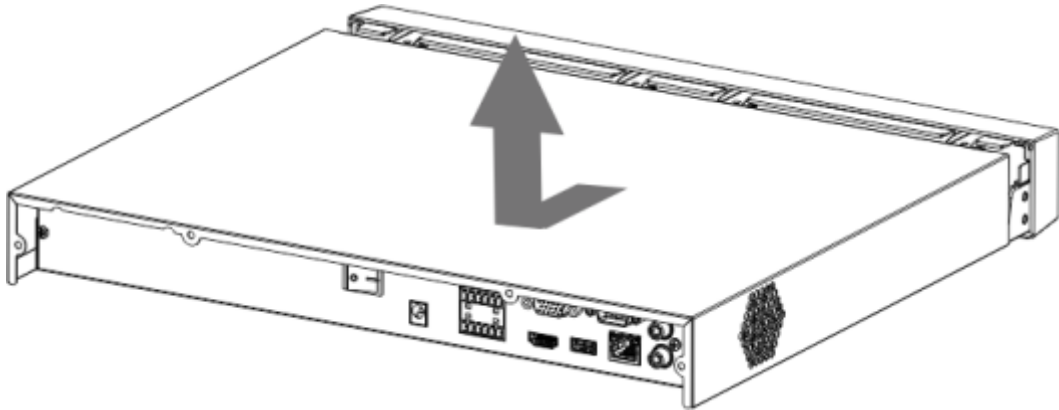

Step 3 Match the four holes on the baseboard to place the HDD.

Figure 3-14 Align HDD

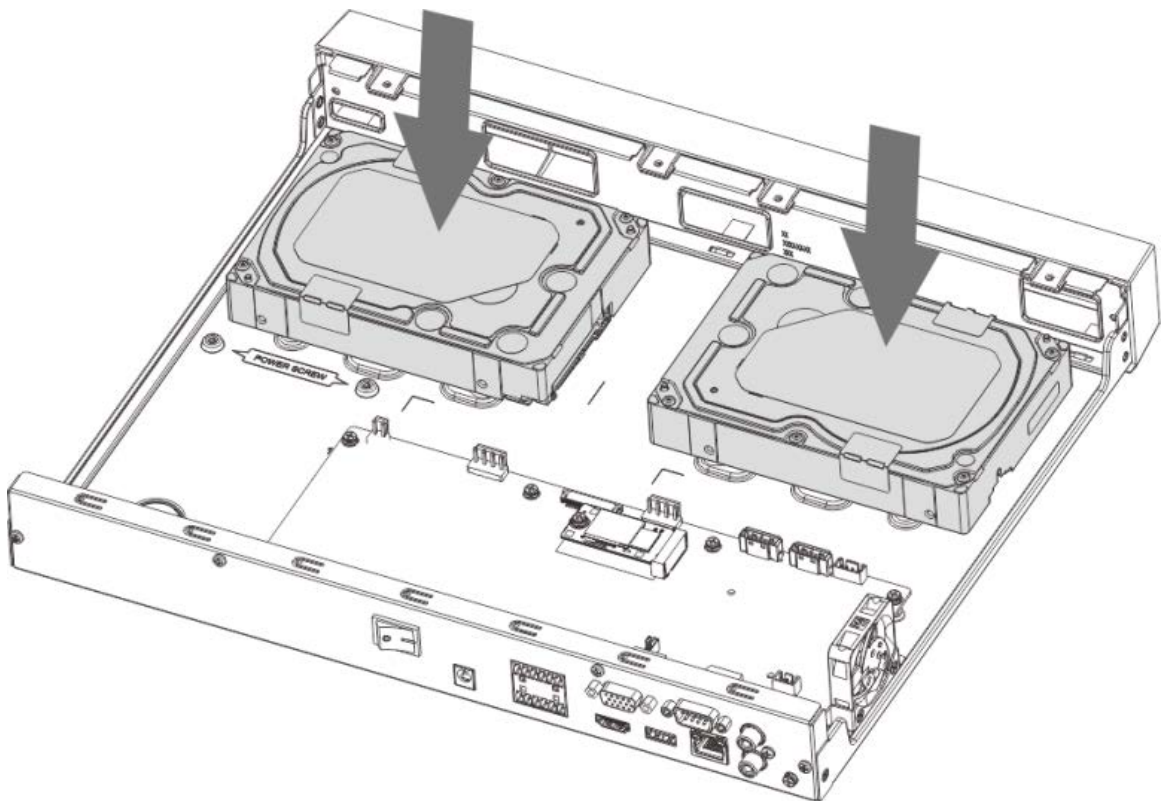

Step 4 Turn the device upside down, match the screws with the holes on the HDD and then fasten them. The HDD is fixed to the baseboard.

Figure 3-15 Fasten screws

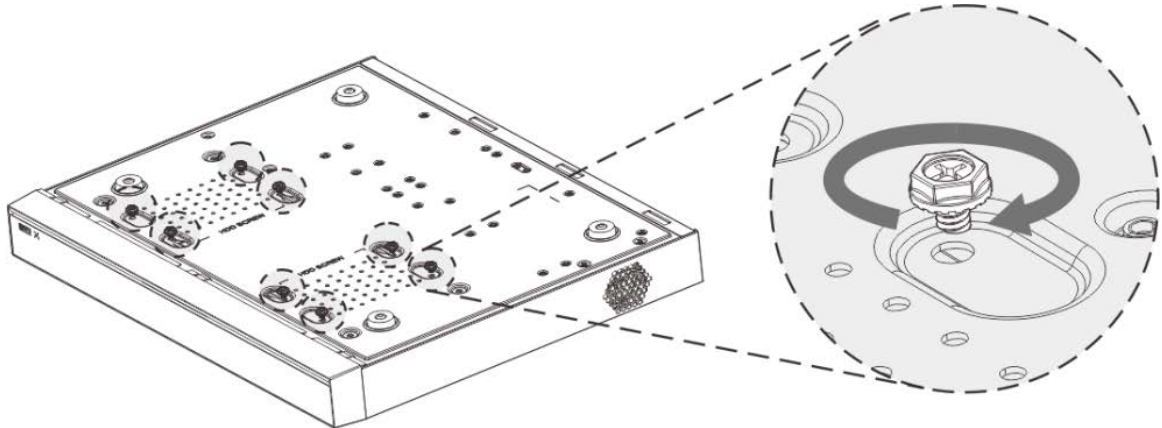

Step 5 Connect the HDD data cable and power cable to the device.

Figure 3-16 Connect cables

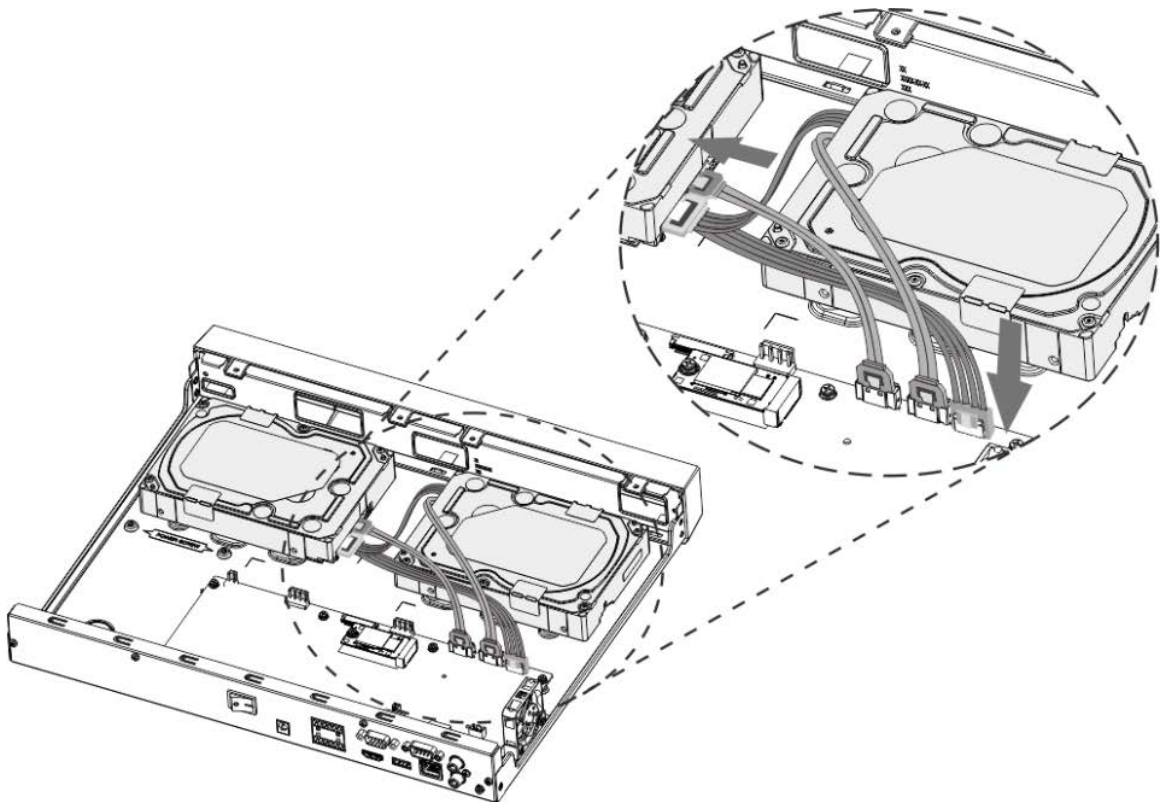

Step 6 Put back the cover and fasten the four screws on the rear panel to complete the installation.

Figure 3-17 Put back cover

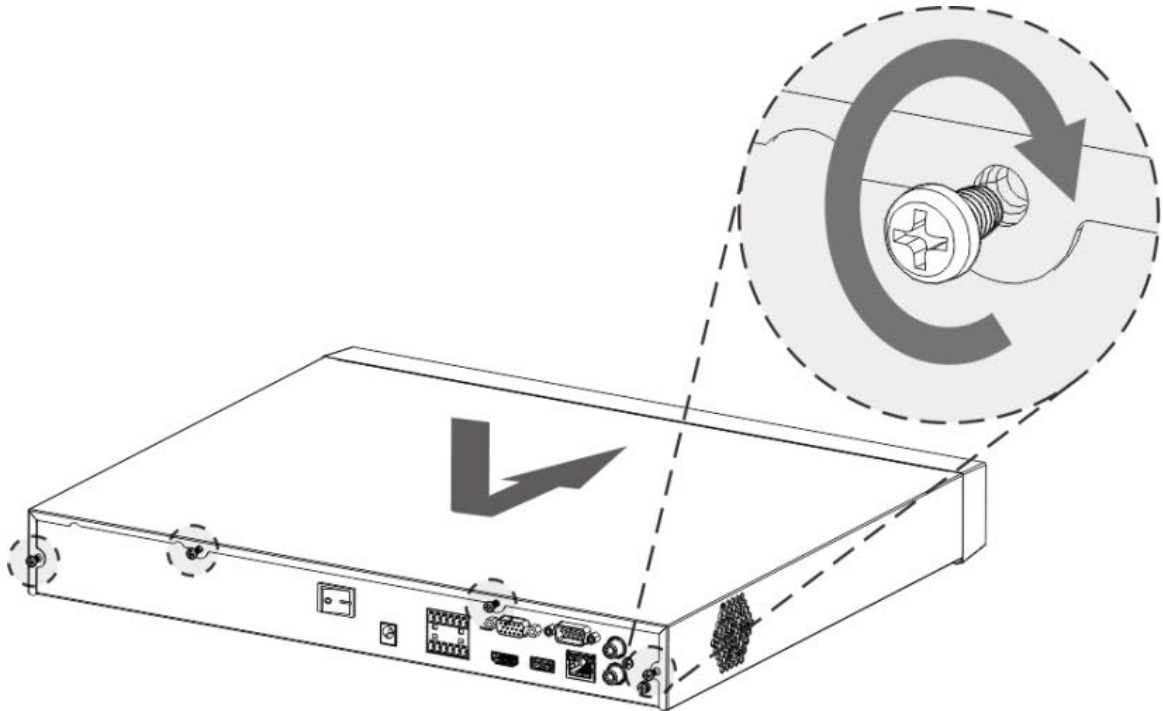

3.3.4

NVR54-4KS2/NVR54-16P-4KS2/NVR44-4KS2/NVR44-16P-4KS2/NVR44-4KS2/L/NVR44-16P-4KS2/L/NVR54-24P-4KS2/NVR54-16P-4KS2E/NVR58-I/NVR58-I/L/NVR54-I/NVR54-I/L/NVR52-I/NVR52-I/L/NVR42-I/NVR42-8P-I/NVR44-I/NVR48-I/NVR608-32-4KS2/NVR44-4KS2/I/NVR44-16P-4KS2/I/NVR48-4KS2/I/NVR48-16P-4KS2/I Series

Background Information



Different models have different number of HDDs.

Procedure

Step 1 Remove the fixing screws on the rear panel of the device.

Figure 3-18 Remove screws

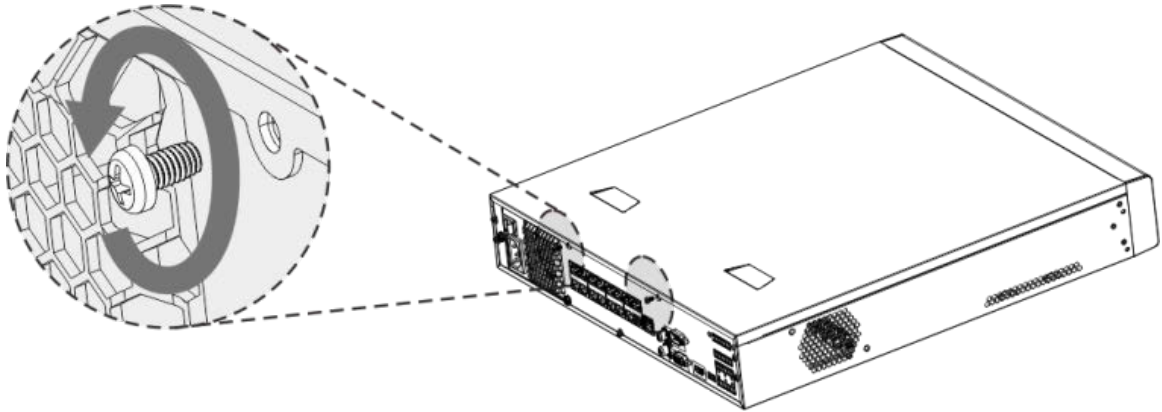

Step 2 Remove the case cover along the direction shown in the following arrow.

Figure 3-19 Remove cover

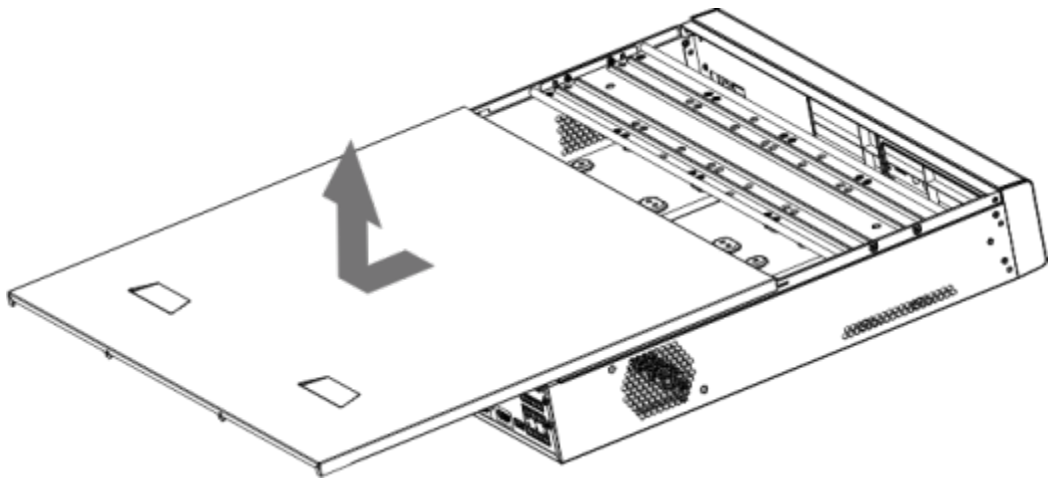

Step 3 Remove the screws on the sides of HDD bracket to take out the bracket.

- 1.5U device has one HDD bracket. For the way to remove the bracket, see Figure 3-20
- 2U device has two HDD brackets. For the way to remove the brackets, see Figure 3-21.

Figure 3-20 Remove screws (1.5U)

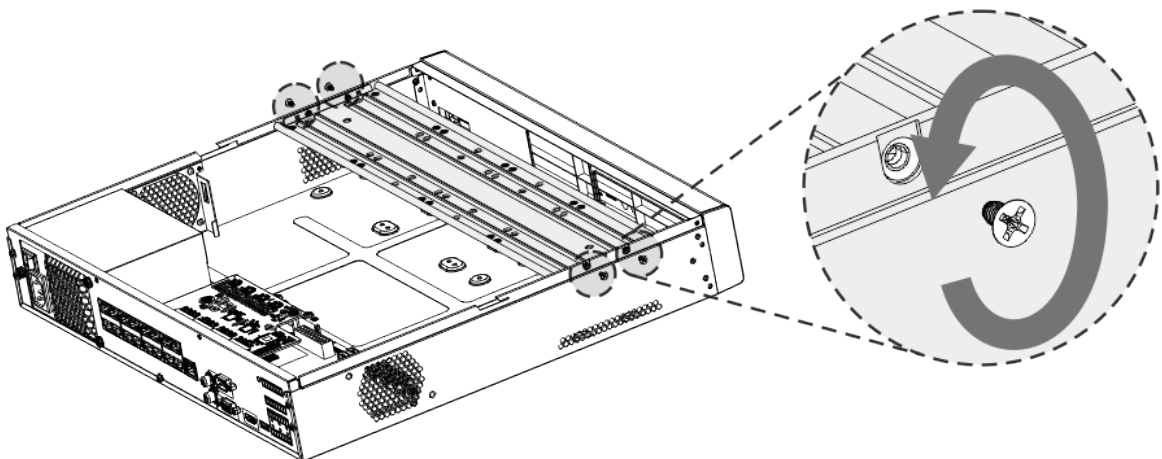
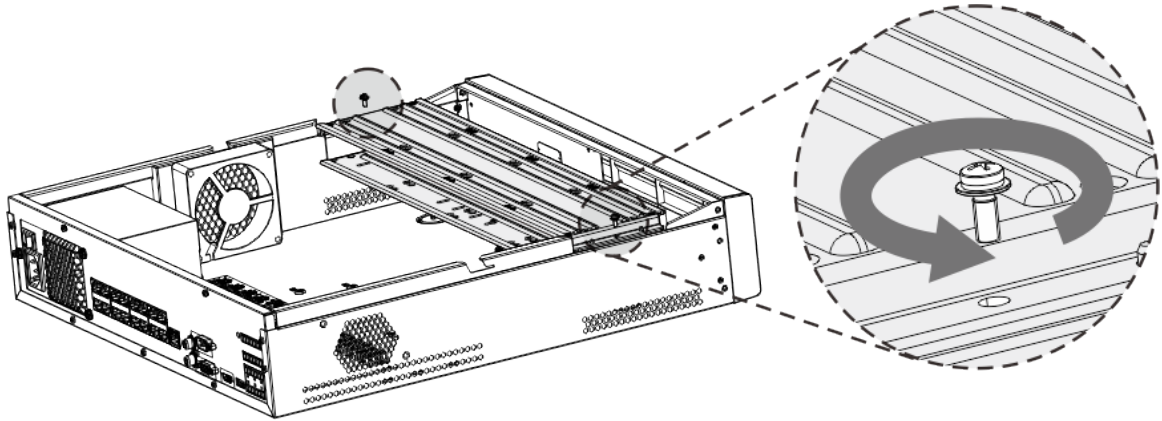
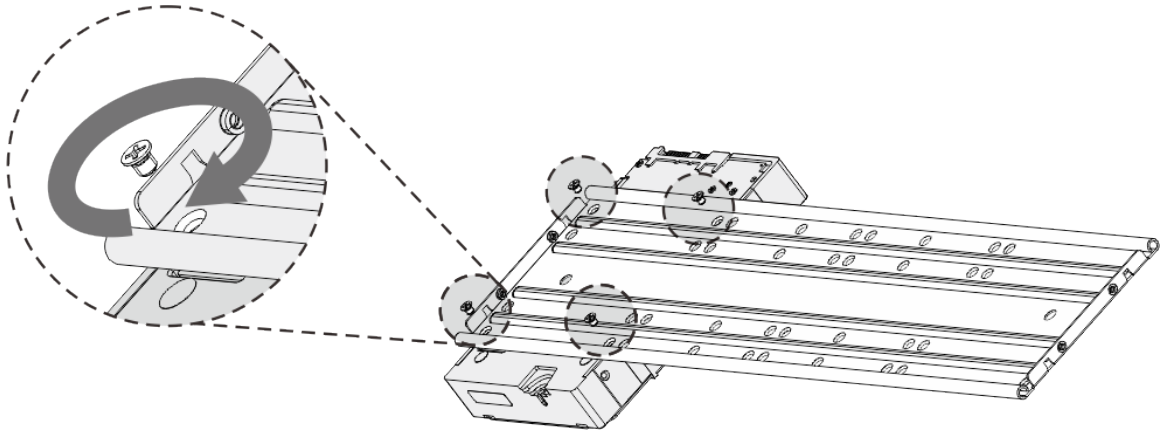

Figure 3-21 Remove screws (2U)



Step 4 Match the four screw holes on the HDD with the four holes on the bracket and then fasten the screws.
The HDD is fixed to the bracket.

Figure 3-22 Fasten screws



Step 5 see Step 4 to install other HDDs.

Figure 3-23 Install more HDDs

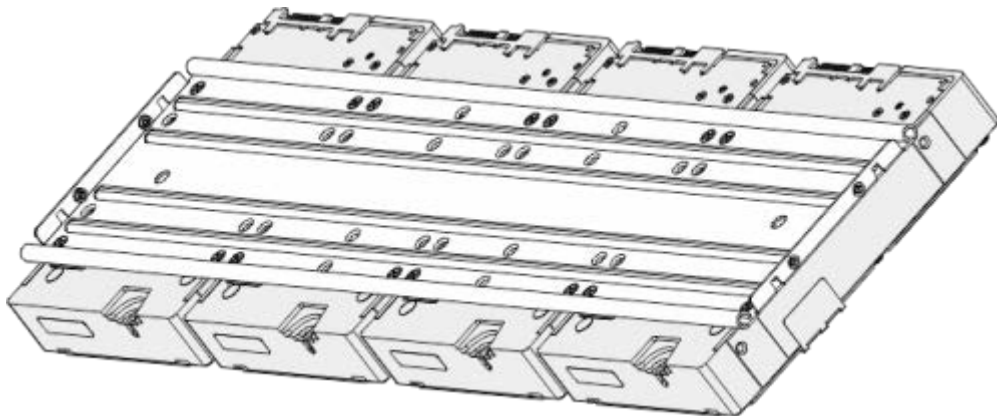

Step 6 Lock the two HDD brackets.



This step is required for 2U devices only.

Figure 3-24 Lock brackets

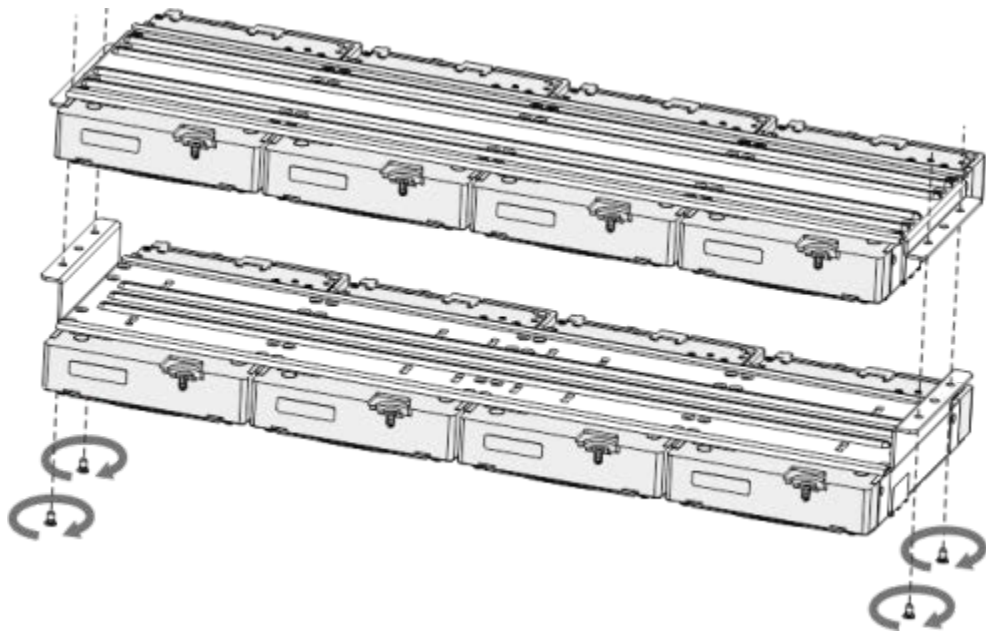

Step 7 Place the bracket to the device and then fasten the screws on the sides of the bracket.

Figure 3-25 Fasten screws

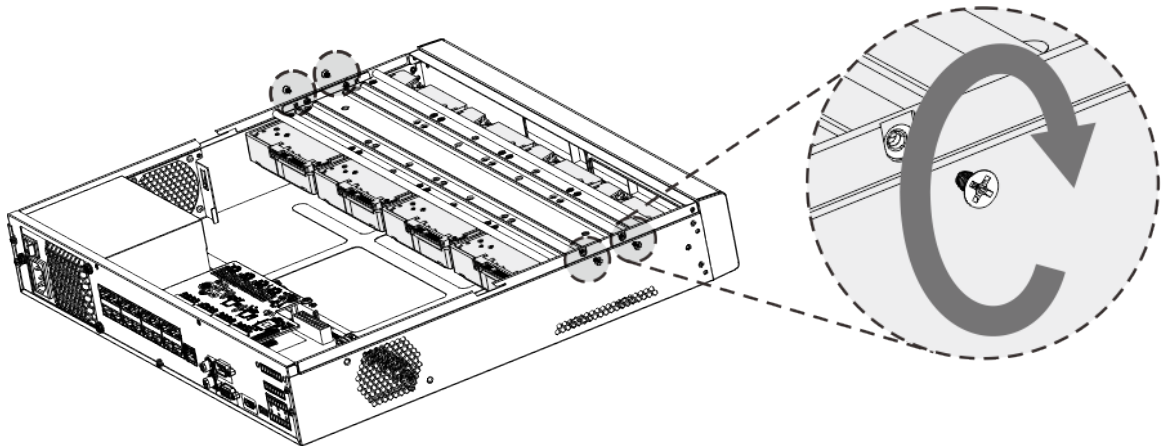

Step 8 Connect the HDD data cable and power cable to the device.



The following figure is for reference only.

Figure 3-26 Connect cables

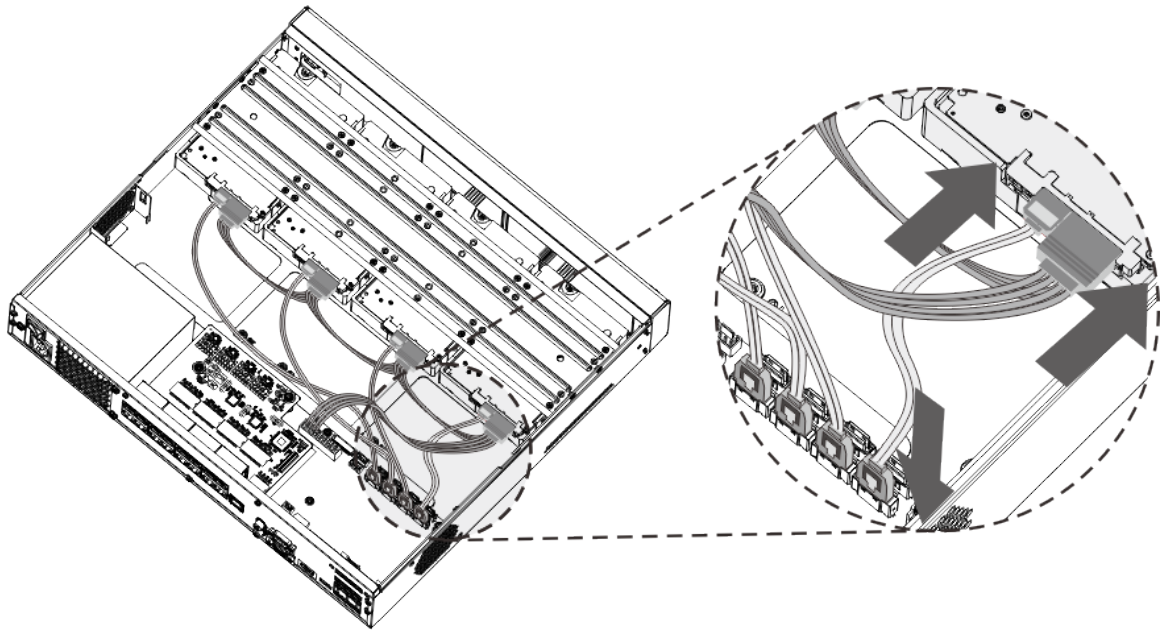

Step 9 Put back the cover and fasten the screws on the rear panel to complete the installation.

Figure 3-27 Fasten screws

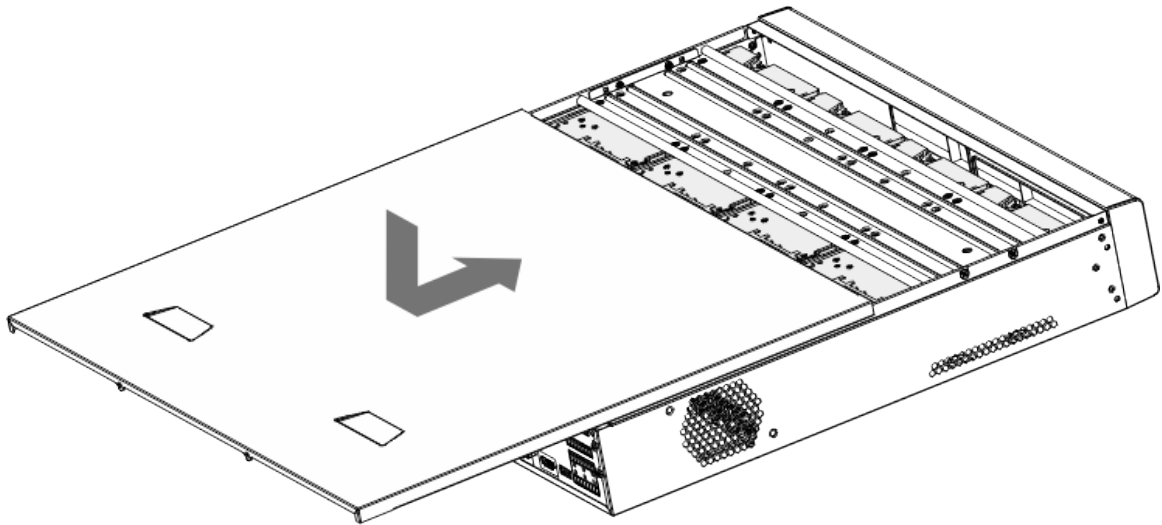

3.3.5

NVR608-64-4KS2/NVR608-128-4KS2/NVR608H-32-XI/NVR608H-64-XI/NVR608H-128-XI Series

Procedure

Step 1 Unlock the lock on the front panel.

Figure 3-28 Unlock front panel

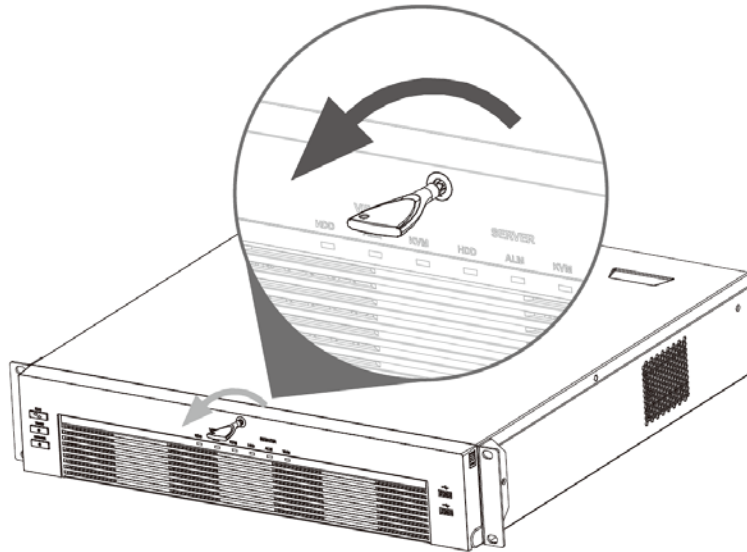

Step 2 Press the button on the 2 sides to open the front panel.

Figure 3-29 Open front panel

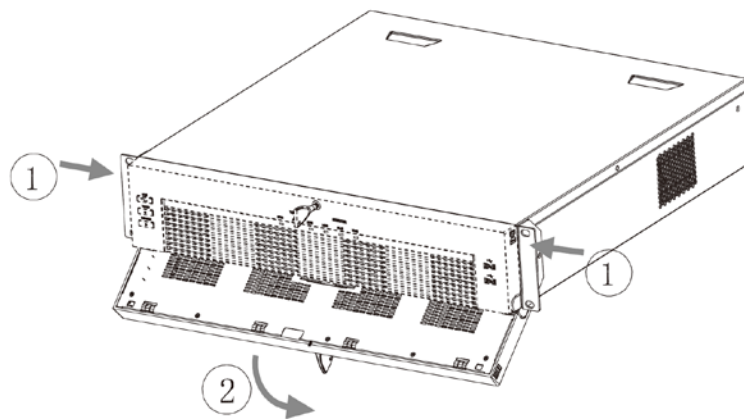

Step 3 Match the 4 screw holes on the HDD with the 4 holes on the bracket and then fasten the screws.

Figure 3-30 Fasten HDD

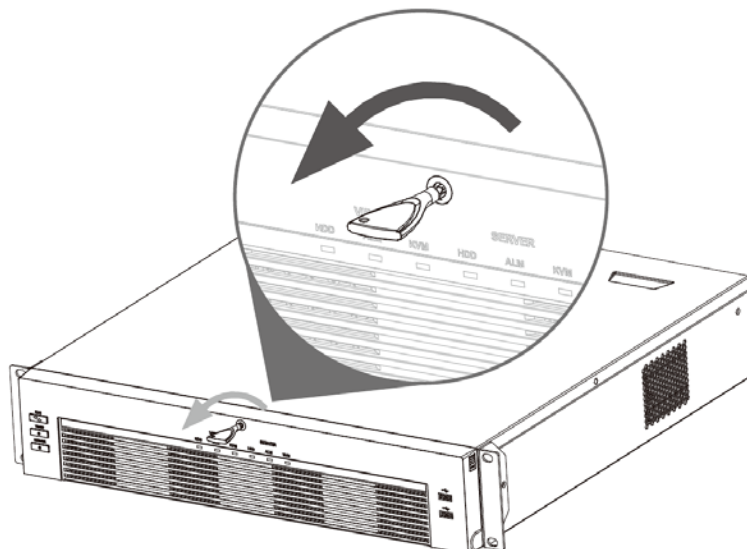

Step 4 Push the HDD box into the device.

Figure 3-31 Unlock front panel

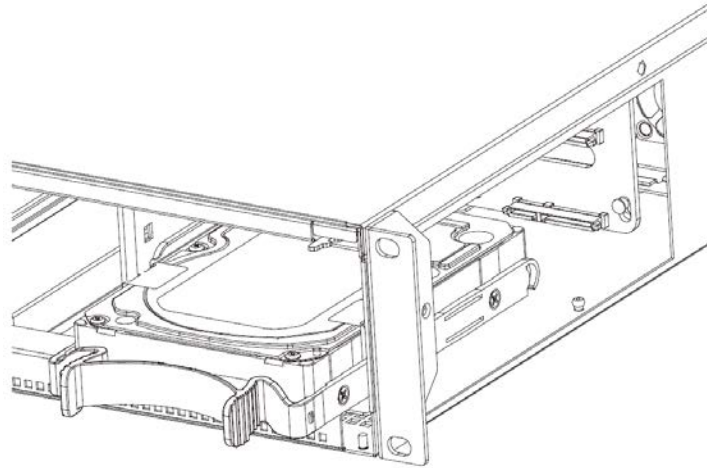

Step 5 Close the front panel and then tighten the lock on the front panel.

Figure 3-32 Lock front panel

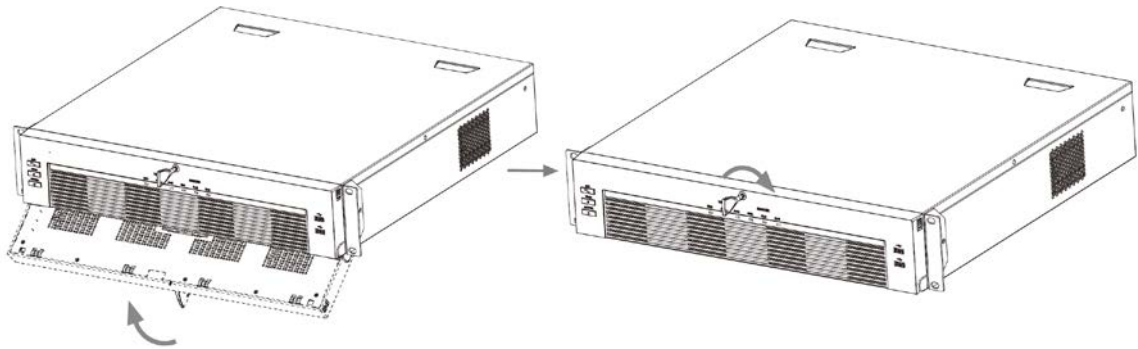

3.3.6 NVR616-4KS2 Series

Background Information



The following figures are for reference only.

Procedure

Step 1 Press the red button on the HDD box, open the handle and then pull out the HDD box.

Figure 3-33 Take out HDD box

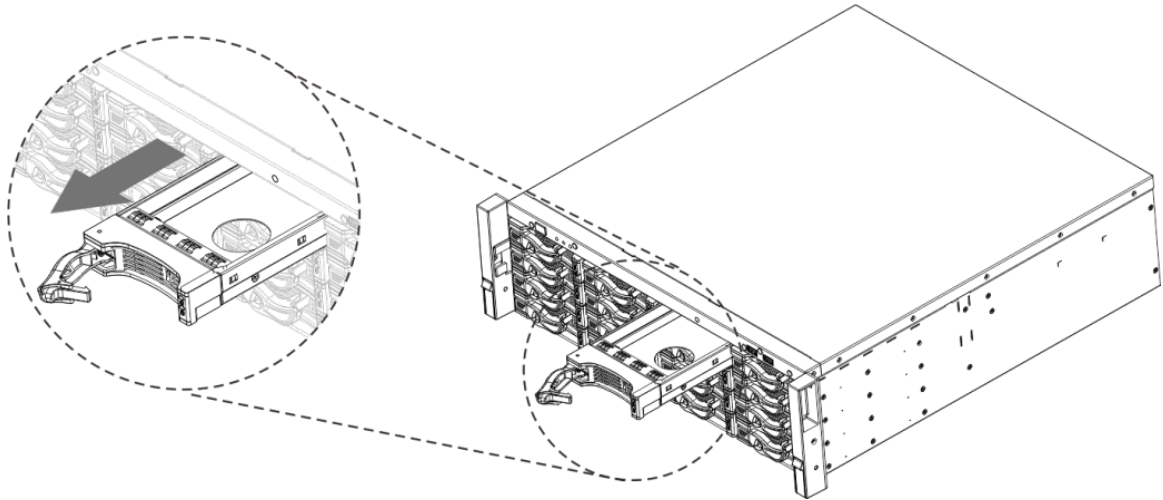

Step 2 Put the HDD into the HDD box along the direction shown in the following arrow.

Figure 3-34 Put HDD into box

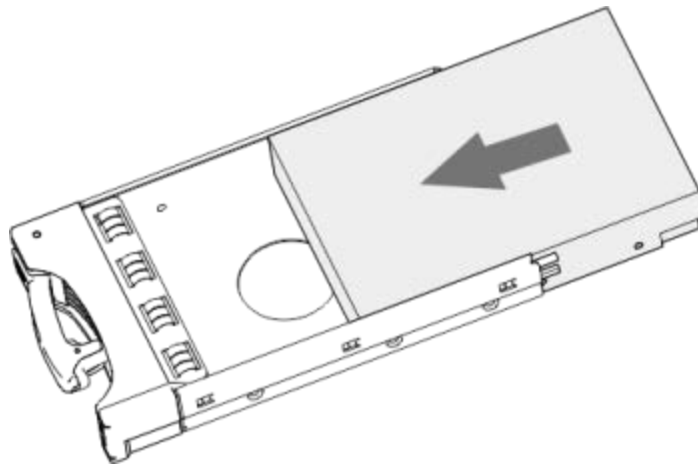

Step 3 Fasten the screws on the sides of the HDD box.

Figure 3-35 Fasten screws

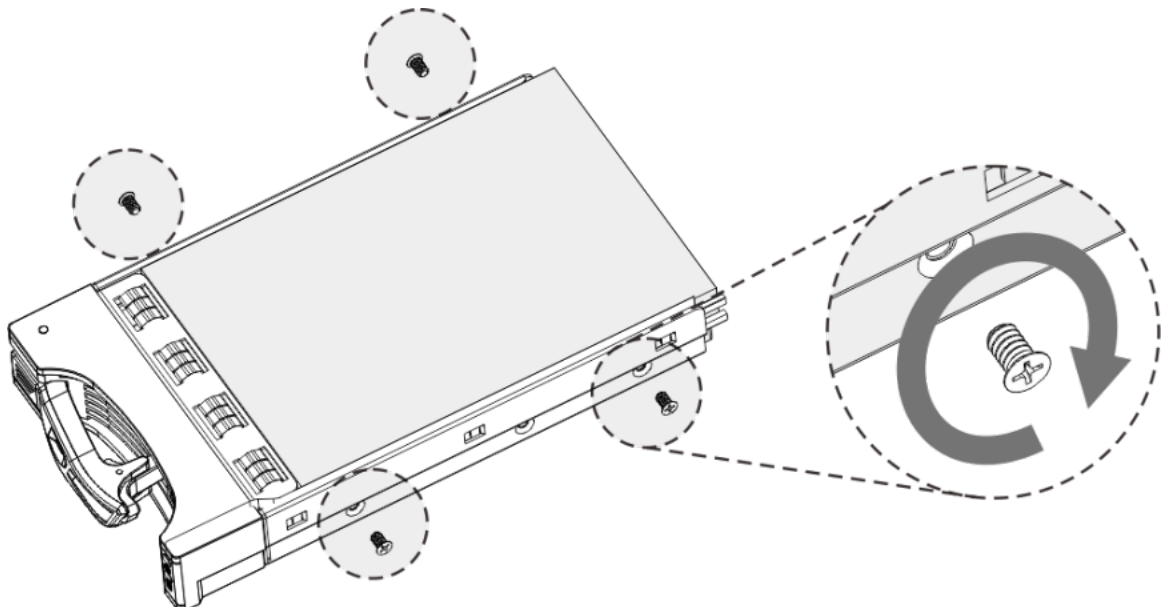

Step 4 Insert the HDD box into the HDD slot, press it to the bottom, and then close the box handle.



If you have not pushed the HDD box to the bottom, do not close the handle to avoid any damage to the HDD slot

Figure 3-36 Close the handle

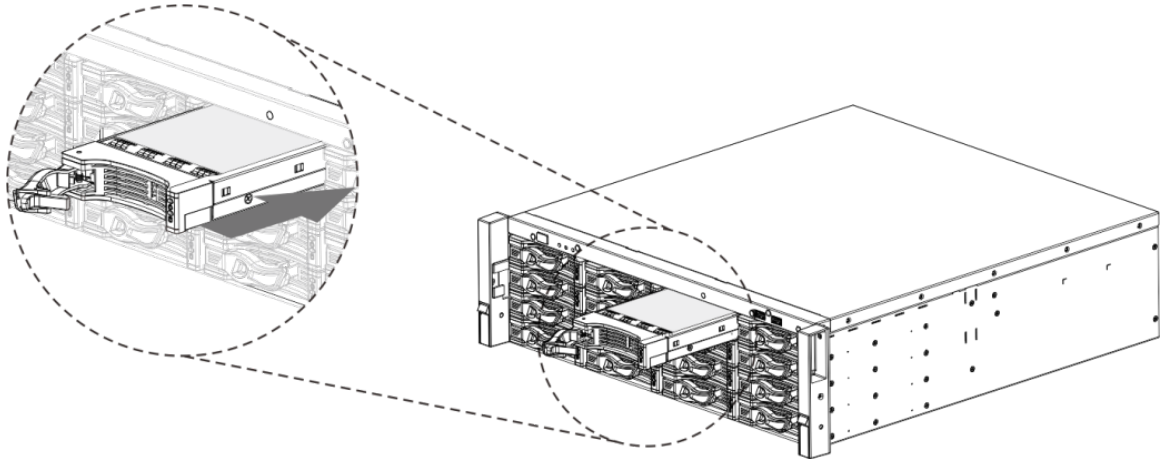

3.4 CD-ROM Installation

Procedure

Step 1 Open the top cover and then remove the HDD bracket.

Figure 3-37 Open the top cover



Step 2 Take off the bottom of the HDD bracket and CD-ROM bracket.

Figure 3-38 Take out HDD bracket



Figure 3-39 Take out CD-ROM bracket



Step 3 Fix the CD-ROM bracket at the HDD bracket.

Figure 3-40 Fix bracket



Step 4 Install a pair of the CD-ROM bracket. Please make sure that the reverse side is secure too.

Figure 3-41 Install bracket



Figure 3-42 Install bracket (reverse side)



Step 5 Install SATA burner. Line up the SATA burner to the hole positions.

Figure 3-43 Install SATA burner



Step 6 Use screw driver to fix the screws.

Figure 3-44 Fasten screws



Step 7 Put the bracket back. Please adjust the CD-ROM to the proper position so that the button of the front panel is directly facing the pop-up button of the CD-ROM.

Figure 3-45 Put bracket back



Step 8 Connect the SATA cable and power wire.

Figure 3-46 Connect cables



Step 9 Secure the HDD bracket and put the top cover back.

Figure 3-47 Put cover back

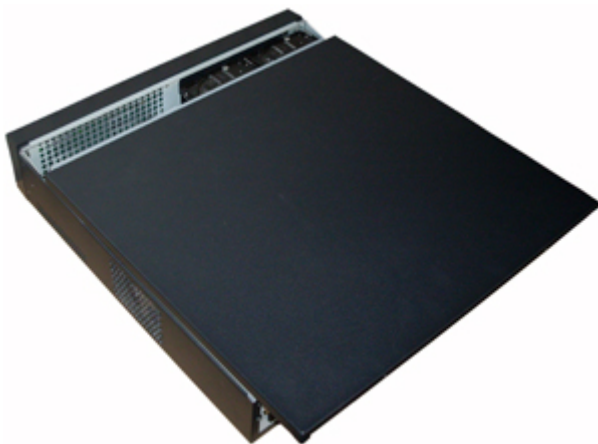

3.5 Connection Sample



The following figures are for reference only and might differ from the actual product.

3.5.1

NVR41-4KS2/NVR41-P-4KS2/NVR41-8P-4KS2/NVR41-4KS2/L/NVR41-P-4KS2/L/NVR41-8P-4KS2/L/NVR21-4KS2/NVR21-P-4KS2/NVR21-8P-4KS2/NVR21-I/NVR21-I2/NVR21-P-I/NVR21-P-I2/NVR21-8P-I/NVR21-8P-I2/NVR21-S3/NVR21-P-S3/NVR21-8P-S3 Series

Figure 3-48 Typical connection

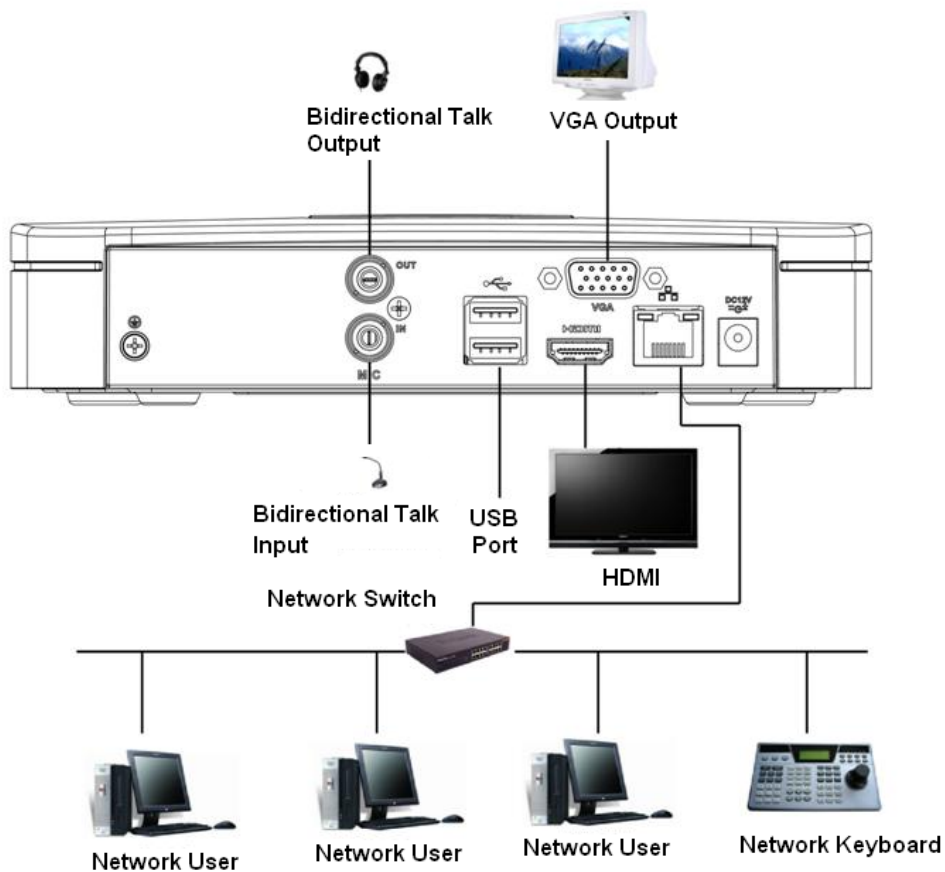

3.5.2 NVR21-W-4KS2/NVR21HS-W-4KS2 Series

Figure 3-49 Typical connection

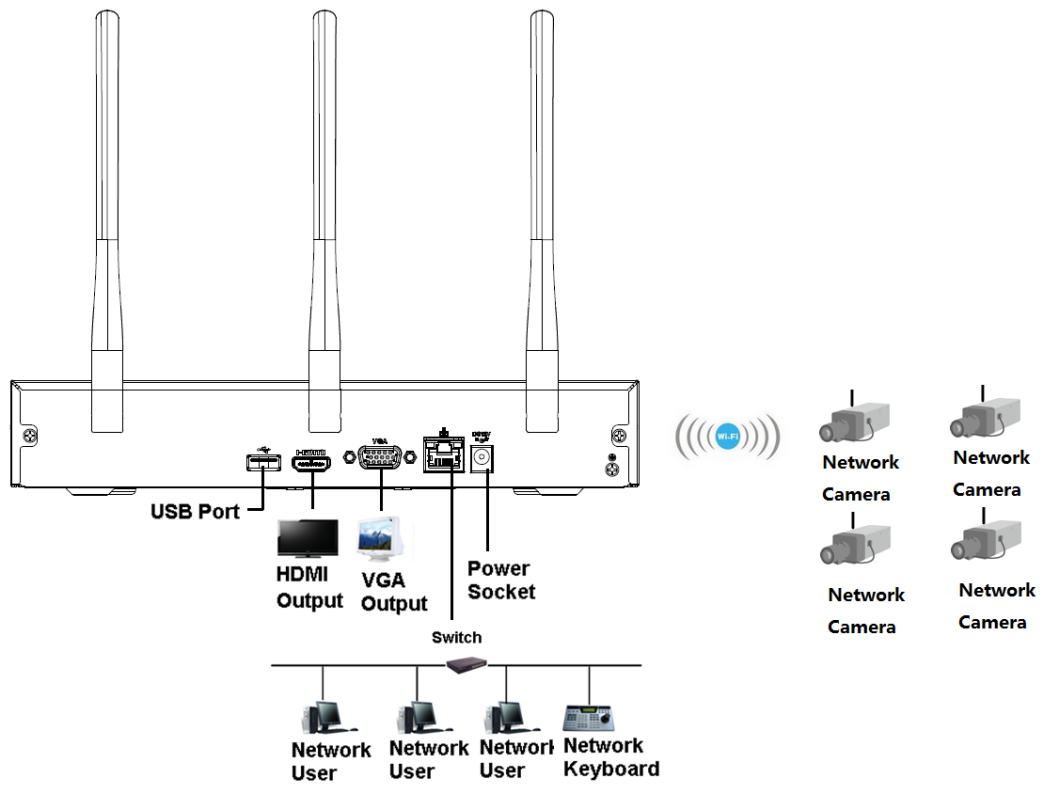

3.5.3

NVR11HS-S3H/NVR11HS-P-S3H/NVR11HS-8P-S3H/NVR41HS-4KS2/ NVR41HS-P-4KS2/NVR41HS-8P-4KS2/NVR41HS-4KS2/L/NVR41HS-P- -4KS2/L/NVR41HS-8P-4KS2/L/NVR21HS-4KS2/NVR21HS-P-4KS2/NV R21HS-8P-4KS2/NVR21HS-I/NVR21HS-I2/NVR21HS-P-I/NVR21HS-P-I 2/NVR21HS-8P-I/NVR21HS-8P-I2/NVR21HS-S3/NVR21HS-P-S3/NVR 21HS-8P-S3 Series

Figure 3-50 Typical connection

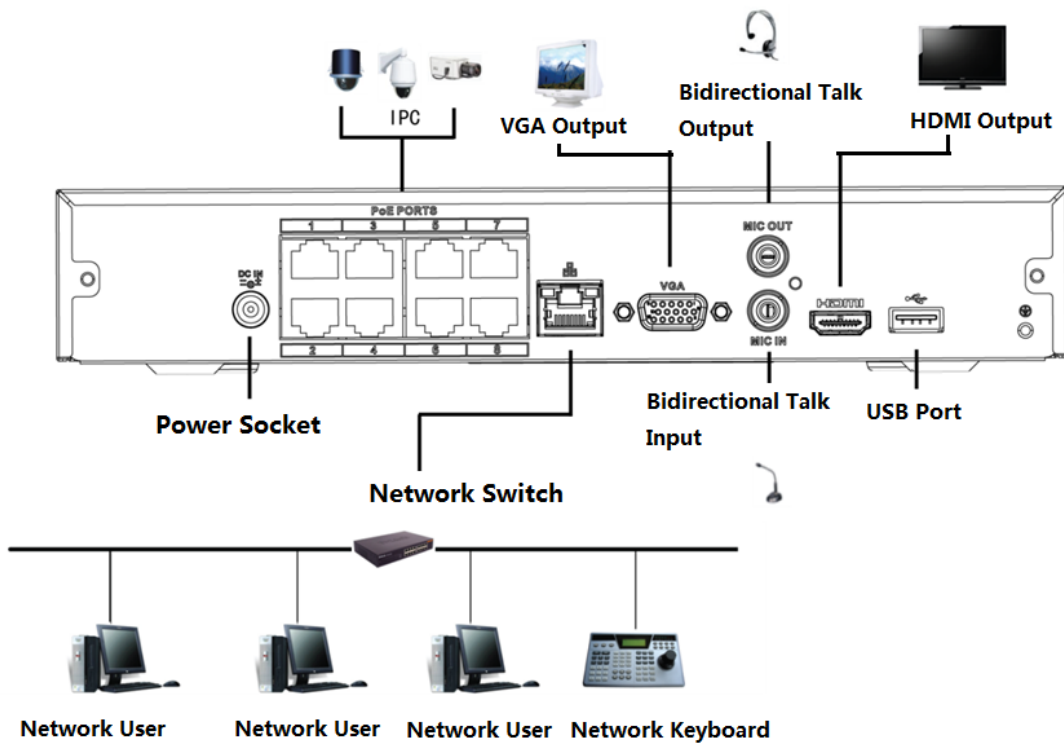

3.5.4

NVR22-4KS2/NVR22-P-4KS2/NVR22-8P-4KS2/NVR22-I/NVR22-I2/NVR22-P-I/NVR22-P-I2/NVR22-8P-I/NVR22-8P-I2/NVR22-16P-I/NVR22-16P-I2 Series

Figure 3-51 Typical connection

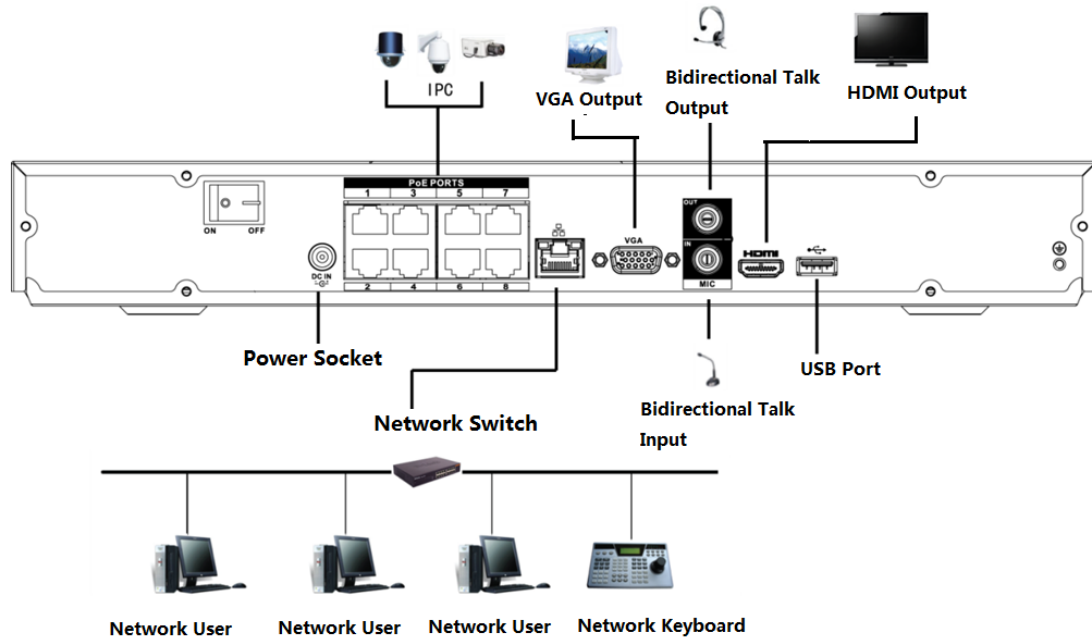

3.5.5

NVR52-4KS2/NVR52-8P-4KS2/NVR52-16P-4KS2/NVR52-24P-4KS2/NVR52-8P-4KS2E/NVR52-16P-4KS2E Series

Figure 3-52 Typical connection

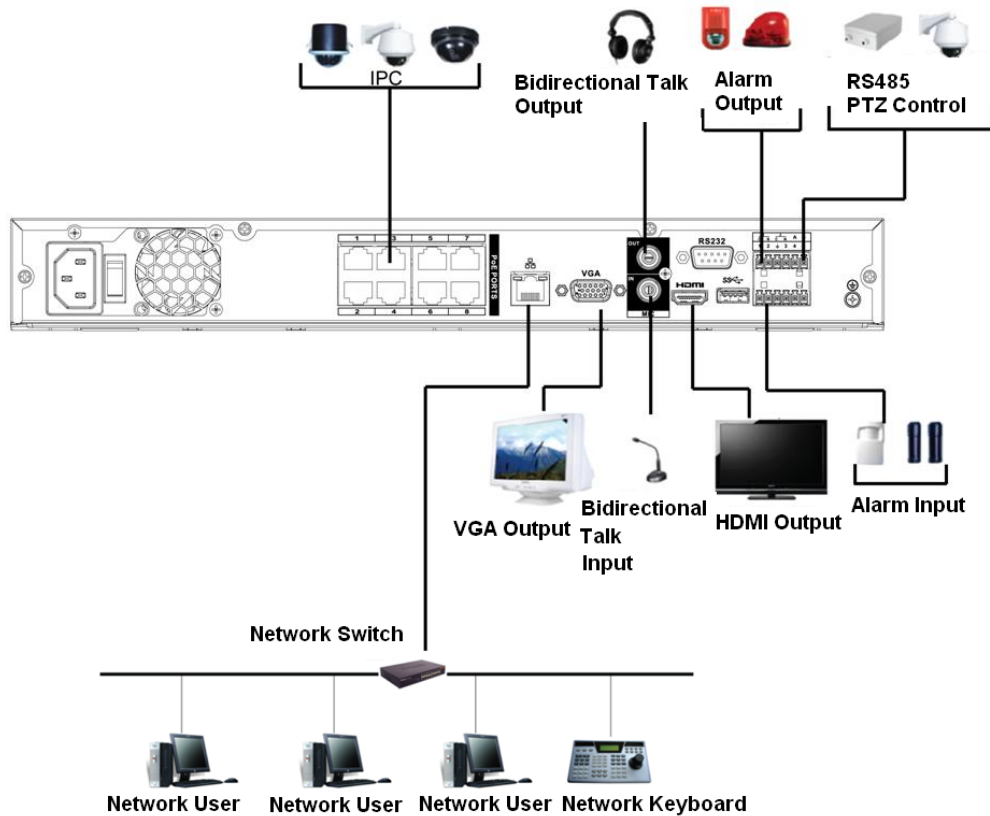

3.5.6

NVR42-4KS2/NVR42-P-4KS2/NVR42-8P-4KS2/NVR42-16P-4KS2/NVR42-4KS2/L/NVR42-P-4KS2/L/NVR42-8P-4KS2/L/NVR42-16P-4KS2/L Series

Figure 3-53 Typical connection

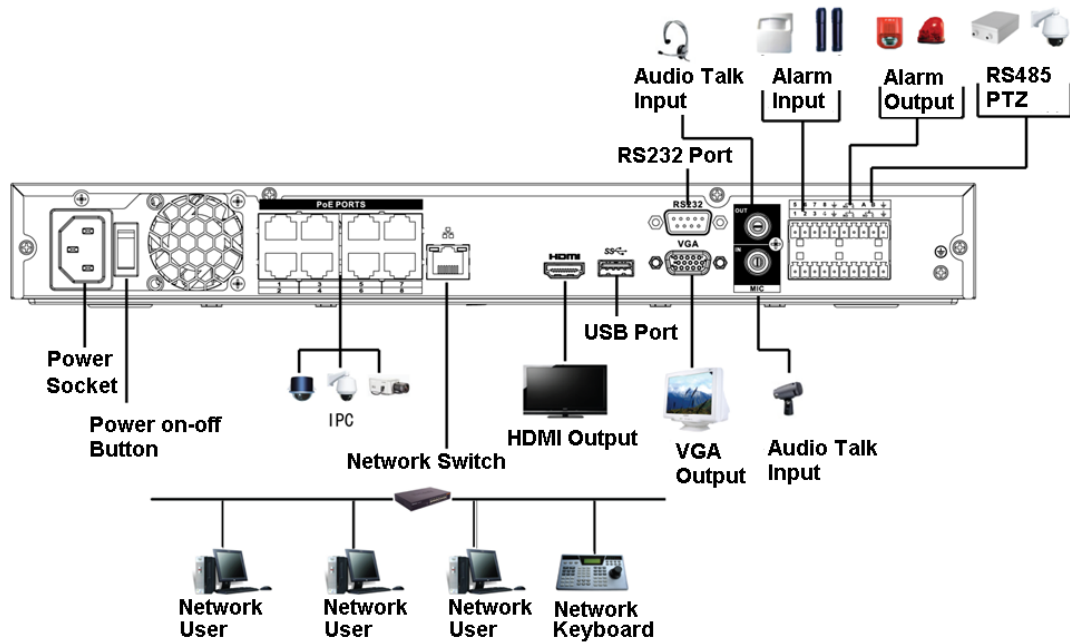

3.5.7

NVR54-4KS2/NVR54-16P-4KS2/NVR58-4KS2/NVR58-16P-4KS2/NVR54-24P-4KS2/NVR54-16P-4KS2E/NVR58-16P-4KS2E Series

Figure 3-54 Typical connection

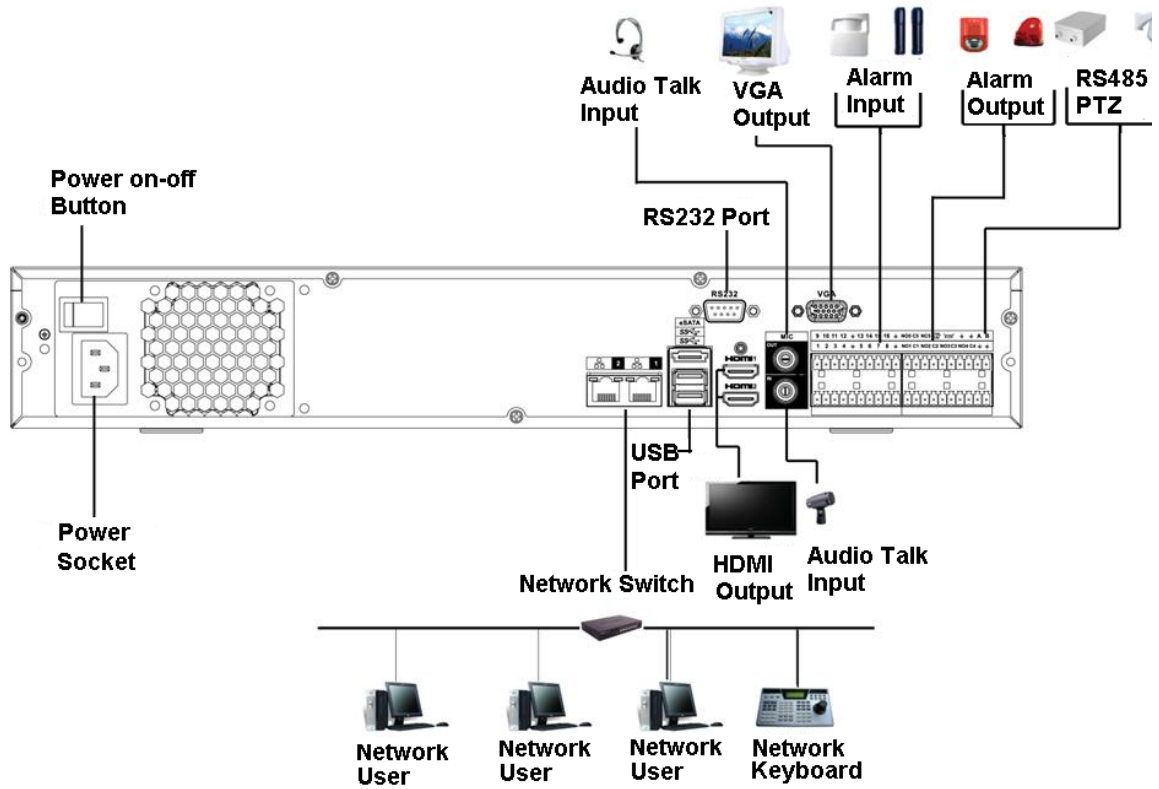

3.5.8

NVR44-4KS2/NVR44-16P-4KS2/NVR44-4KS2/L/NVR44-16P-4KS2/L/ NVR44-4KS2/I/NVR44-16P-4KS2/I Series

Figure 3-55 Typical connection

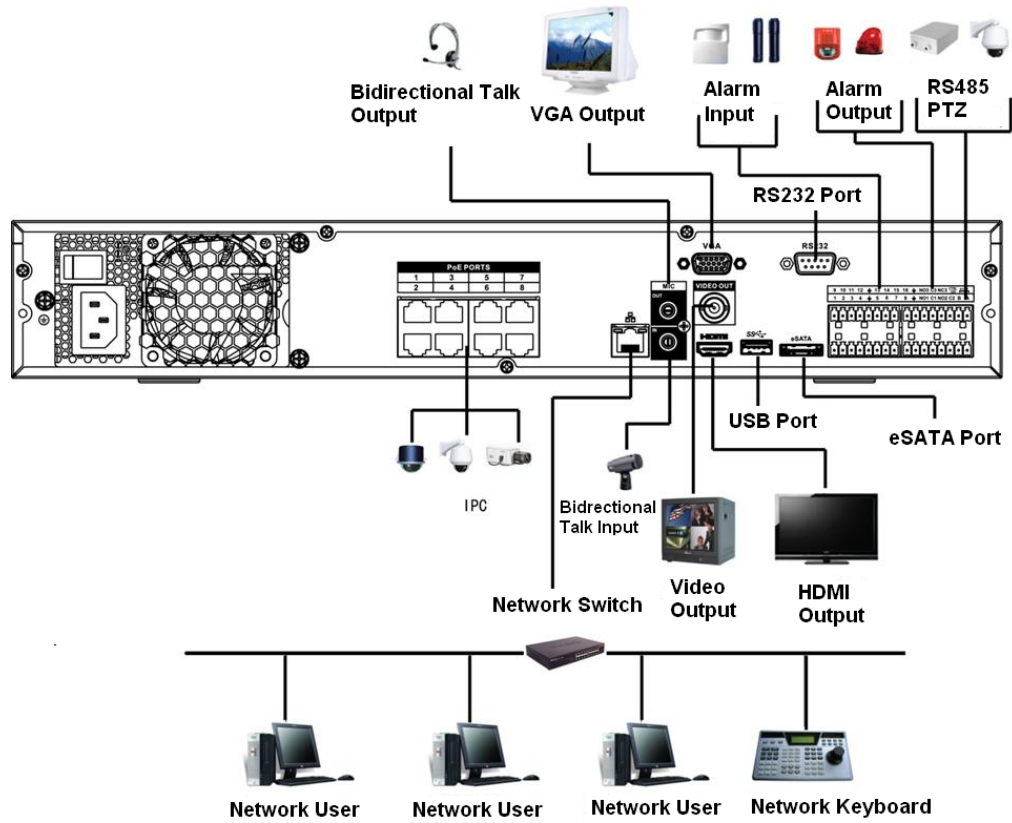

3.5.9

NVR48-4KS2/NVR48-16P-4KS2/NVR48-4KS2/L/NVR48-16P-4KS2/L/ NVR48-4KS2/I/NVR48-16P-4KS2/I Series

Figure 3-56 Typical connection

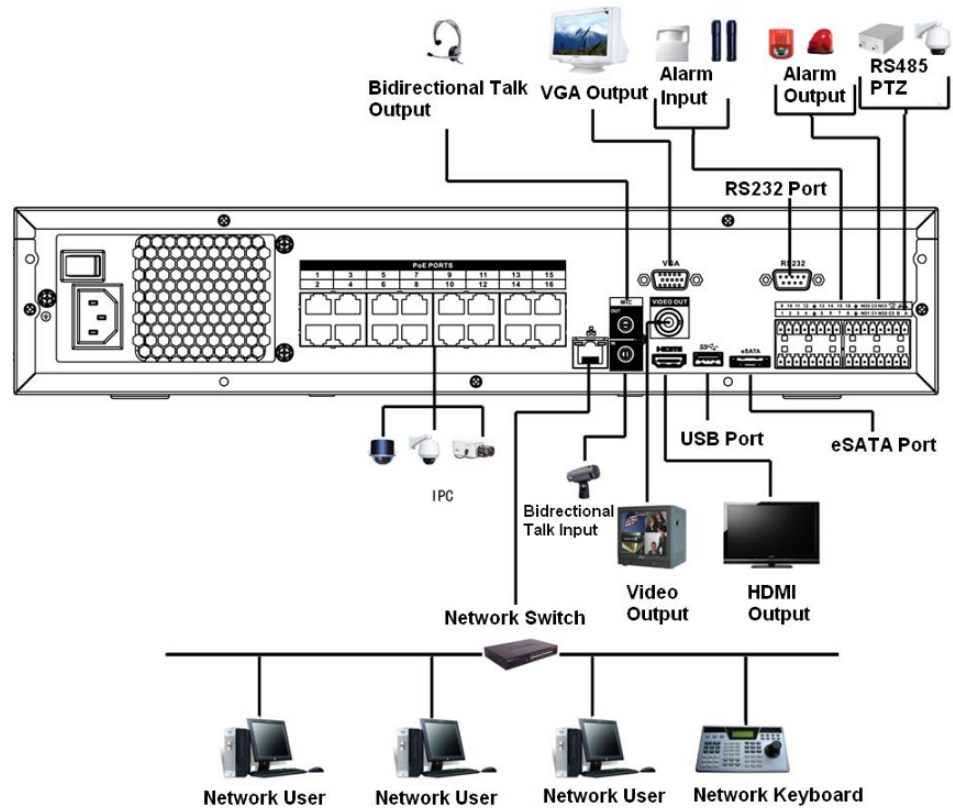

3.5.10 NVR58-I/NVR58-I/L/NVR48-I Series

Background Information

Figure 3-57 Typical connection

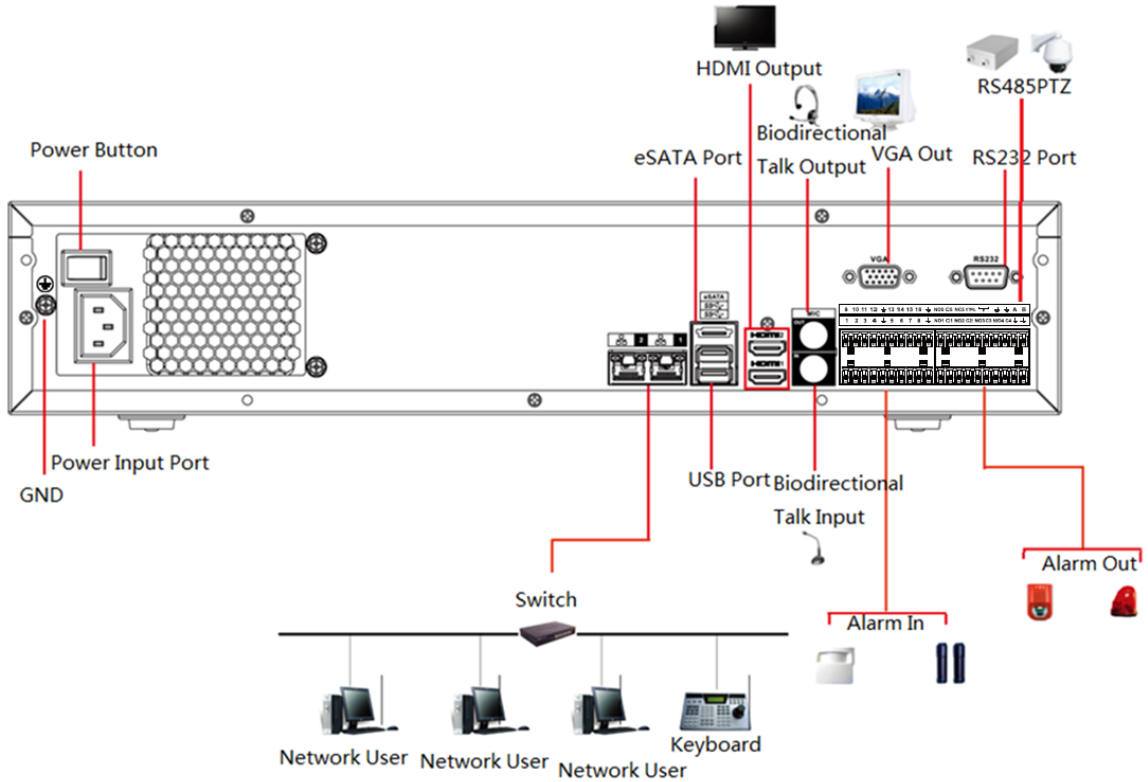

3.5.11 NVR54-I/NVR54-I/L/NVR44-I

Figure 3-58 Typical connection

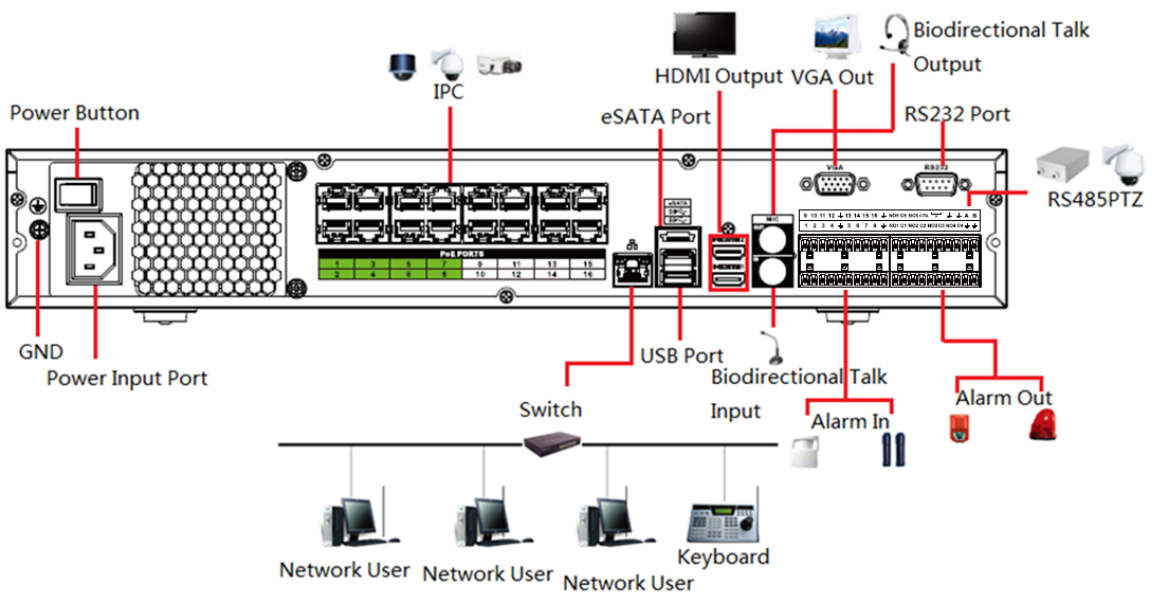

3.5.12

NVR52-16P-I/NVR52-16P-I/L/NVR52-8P-I/NVR52-8P-I/L/NVR42-8P-I/ NVR42-16P-I Series

Figure 3-59 Typical connection

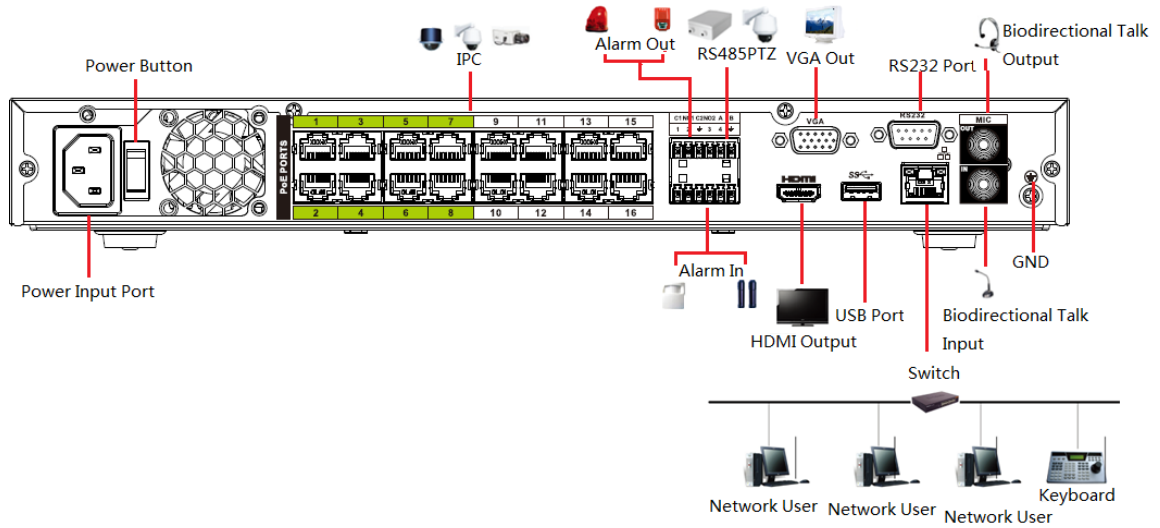

3.5.13 NVR4216-I Series

Figure 3-60 Typical connection

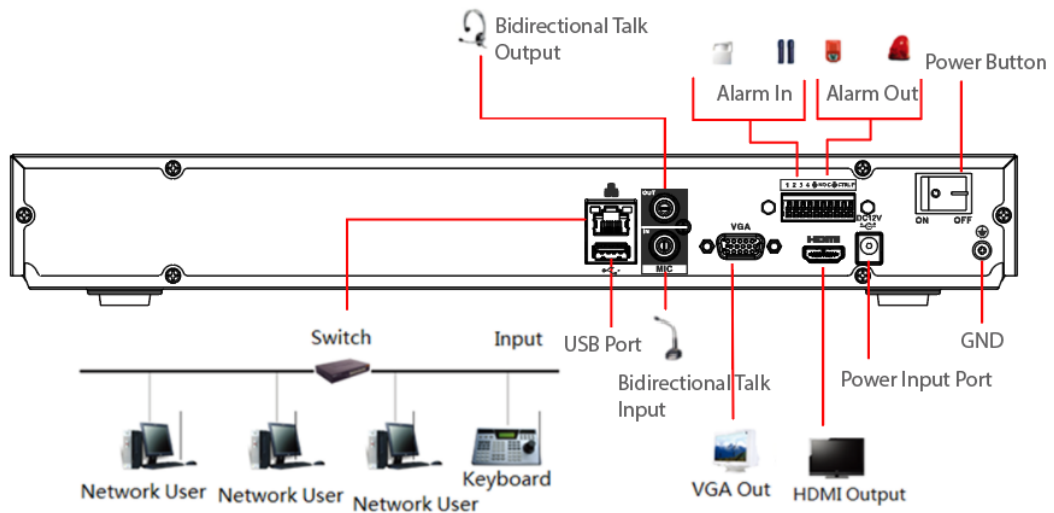

3.5.14 NVR608-4KS2/NVR608H-XI/NVR608RH-XI Series



The following figure is for reference only and might differ from the actual product.

Figure 3-61 Typical connection

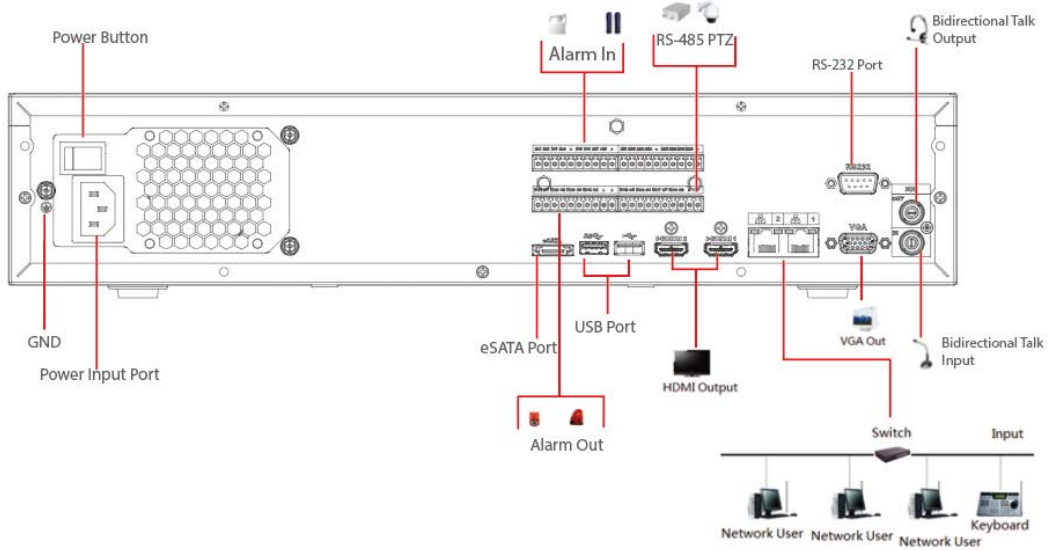

3.5.15 NVR616-4KS2 Series

Figure 3-62 Typical connection

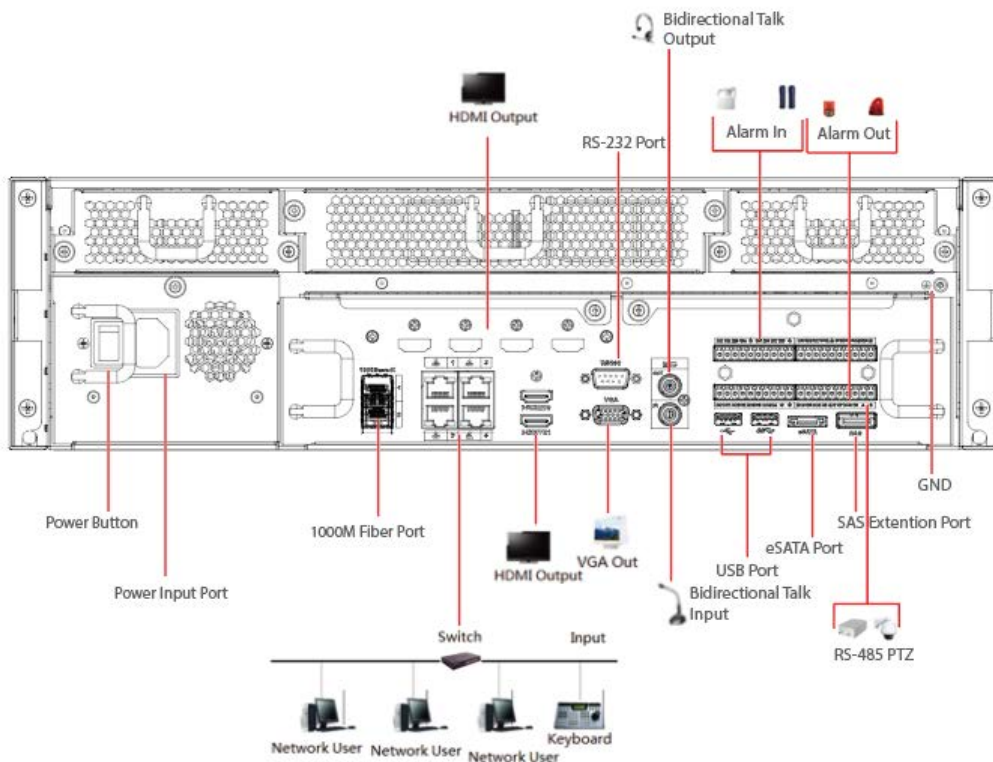

4 Starting the Device

Background Information



- For device security, connect the NVR to the power adapter first and then connect the device to the power socket.
- The rated input voltage matches the device power button. Make sure the power wire connection is OK. Then press the power button.
- Always use the stable current, if necessary UPS is a best alternative measure.

Procedure

Step 1 Connect the device to the monitor and then connect a mouse.

Step 2 Connect power cable.

Step 3 Press the power button on the front panel or turn on the power switch on the rear panel to start up the device.

After the device starts, the system is in multiple-channel display mode by default.



The Device will verify license during starting up. If the verification failed, the icon  is displayed on the screen. Contact the technical support.

5 Local Operations



The following figures are for reference only. Slight difference might be found on the actual interface.

5.1 Initialization

Background Information

- For first-time use, set a login password for the admin account (default user).
- We recommend setting password protection so that you can reset password in case you forgot.



- For your device safety, keep your login password well, and change the password regularly.
- The IP address of the Device is 192.168.1.108 by default.

Procedure

Step 1 Start the NVR.

Step 2 Set region, time zone, and time according to the actual situation, and then click **Next**.





Click to shut down the device. The system integrator or the user can shut down the Device directly after setting the time zone.

Step 3 Set the login password for the admin account and then click **Next**.

Figure 5-1 Set password

Table 5-1 Password parameters

Parameter	Description
User	By default, the user is admin.
Password	Enter the password for admin and then confirm the password.

Parameter	Description
Confirm Password	
Password Hint	Enter the information that can remind you of the password.  On the login window, click  to display the password hint.

Step 4 Set unlock pattern.



- The pattern that you want to set must cross at least four points.
- If you do not want to configure the unlock pattern, click **Skip**.
- Once you have configured the unlock pattern, the system will require the unlock pattern as the default login method. If you did not configure the unlock pattern, you need to enter password for login.

Figure 5-2 Draw unlock pattern

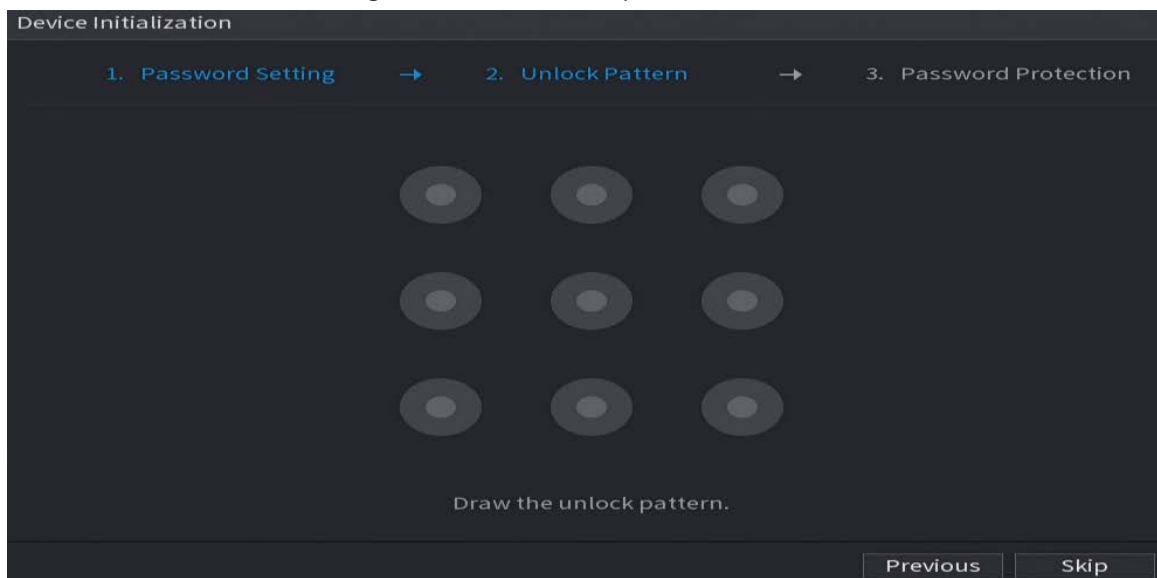

Step 5 Set password protection.

- After configuration, if you forgot the password for admin user, you can reset the password through the linked email address or security questions. For details on resetting the password, see "5.13.3 Resetting Password".
- If you do not need password protection, disable **Reserved Email** and **Security Question**.

Figure 5-3 Set password protection

The screenshot shows the 'Device Initialization' screen at the '3. Password Protection' step. It features three progress indicators: '1. Password Setting', '2. Unlock Pattern', and '3. Password Protection'. Below the indicators are several configuration options:

- Reserved Email:** A checkbox that is checked, followed by an empty text input field. A note to the right says: 'For password reset. Recommended or improved in time.'
- Security Question:** A checkbox that is checked.
- Question 1:** A dropdown menu with the text 'What is your favorite children's book?' and a downward arrow.
- Answer:** An empty text input field.
- Question 2:** A dropdown menu with the text 'What was the first name of your first boss?' and a downward arrow.
- Answer:** An empty text input field.
- Question 3:** A dropdown menu with the text 'What is the name of your favorite fruit?' and a downward arrow.
- Answer:** An empty text input field.

An 'OK' button is located at the bottom right of the screen.

Table 5-2 Security question parameters

Password Protection Mode	Description
Email Address	Enter the linked email address. Enter an email address for password reset. If you forgot the password, enter the security code that you will get from this linked email address to reset the password of admin.
Security Questions	Configure the security questions and answers. If you forgot the password, you can reset the password after entering the answers to the questions.

Step 6 Click **Save**.

5.2 Startup Wizard

Background Information

After initialization, the system goes to **Startup Wizard**. You can quickly configure your device.



Startup Wizard is displayed only when you log in to the Device for the first time or have restored the Device to factory settings.

Procedure

Step 1 Select **Auto Check for Updates**, and then click **Next**.

If you select the **Auto Check for Updates** checkbox, the system will notify you automatically when updates are available.

Figure 5-4 Startup wizard

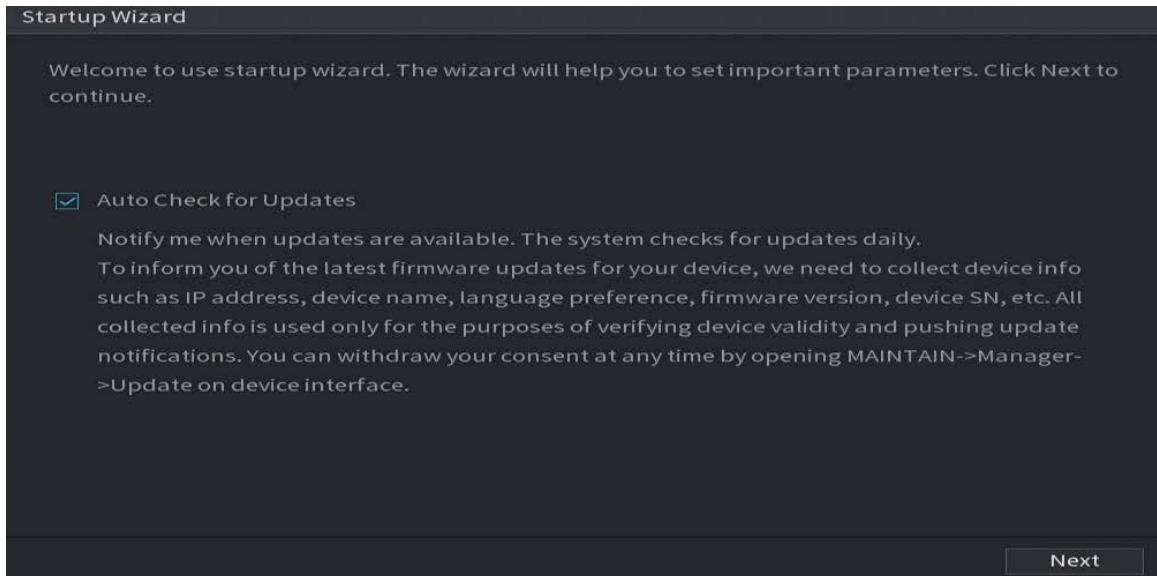

Step 2 Configure IP address, and then click **Next**.



The number of network adapters might vary with models. Configure the IP address of the network adapter according to the actual connection situation.

1) Click .



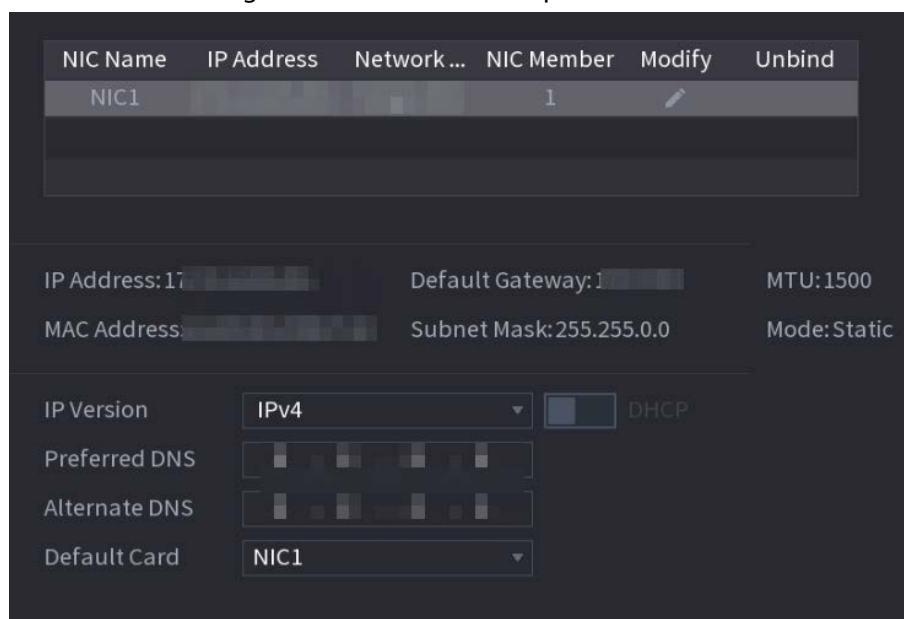

Figure 5-5 Edit network adapter



2) Configure parameters.

Table 5-3 Network parameters

Parameter	Description
Network Mode	<ul style="list-style-type: none"> Single NIC: Two network adapters work separately. If one of the

Parameter	Description
Default Ethernet Port	<p>two network adapters is disconnected, the system network status is regarded as offline.</p> <ul style="list-style-type: none"> Fault Tolerance <p>: Two network adapters share one IP address. Normally only one network adapter is working. When this adapter fails, the other network adapter will start working automatically to ensure the network connection. </p> <ul style="list-style-type: none"> When you test the network status, the network is regarded as offline only when both network adapters are disconnected. The two network adapters are used under the same LAN. Load Balance <p>: Two network adapters share one IP address. The two adapters work at the same time to share the network load averagely. If one of them fails, the other can continue working normally. </p> <ul style="list-style-type: none"> When testing the network status, the network is regarded as offline only when both of the two network adapters are disconnected. The two network adapters are used under the same LAN. <p> The Device with single Ethernet port does not support this function.</p>
IP Version	Select IPv4 or IPv6 . Both versions are supported for access.
DHCP	Enable the system to automatically obtain a dynamic IP address.
MAC Address	Displays the MAC address of the Device.
IP Address	<ul style="list-style-type: none"> Enter the IP address and then configure the corresponding subnet mask and default gateway. After configuration, click Test to check whether there is conflict in IP address. <p> IP address and default gateway must be on the same network segment.</p>
Subnet Mask	
Default Gateway	



To unbind NIC, on the **TCP/IP** page, click . The unbinding will take effect after the Device restarts.

- On the **TCP/IP** page, configure DNS server. This step should be performed when you enable the domain name service.

You can get DNS server address or manually enter it.

- Automatically get DNS server address: When there is a DHCP server in the network, you can enable **DHCP**, and then the Device gets a dynamic IP address.
- Enter DNS server address: Select **IP Version**, and then configure the preferred DNS server and alternate DNS server.

- 4) On the **Default Card** drop-down list, select the default NIC.
- 5) Click **Next**.

Step 3 Enable **P2P**, and then click **Next**.

Scan the QR code on the actual interface to download the app. Register an account and then you can add the Device to the app.



Before using the P2P function, make sure that the NVR has connected to the WAN.

The **Status** becomes **Online** after you successfully configure P2P.

Figure 5-6 P2P

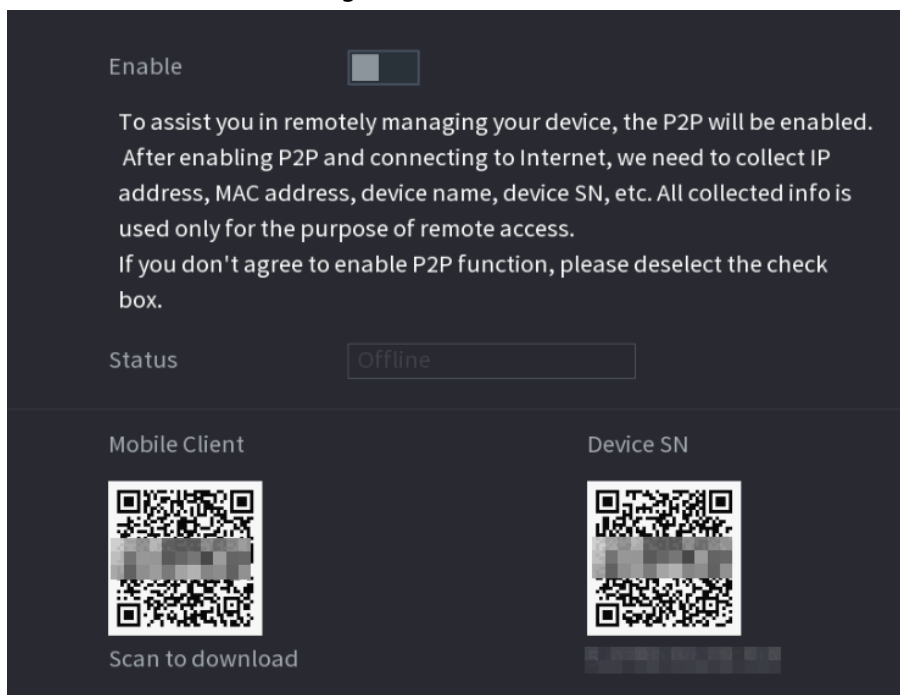

Step 4 Add cameras according to the actual situation.

After adding cameras, you can view the video images transmitted from the cameras, and change camera configuration.



- The number of cameras that can be added to the NVR varies with models.
- The system supports adding camera through searching, manual add and batch add. This section uses adding by searching as an example.
- Initialize the camera before adding to the Device.

1) Click **Search Device**.

The devices found are displayed at the upper pane, excluding devices already added.

Figure 5-7 Search device

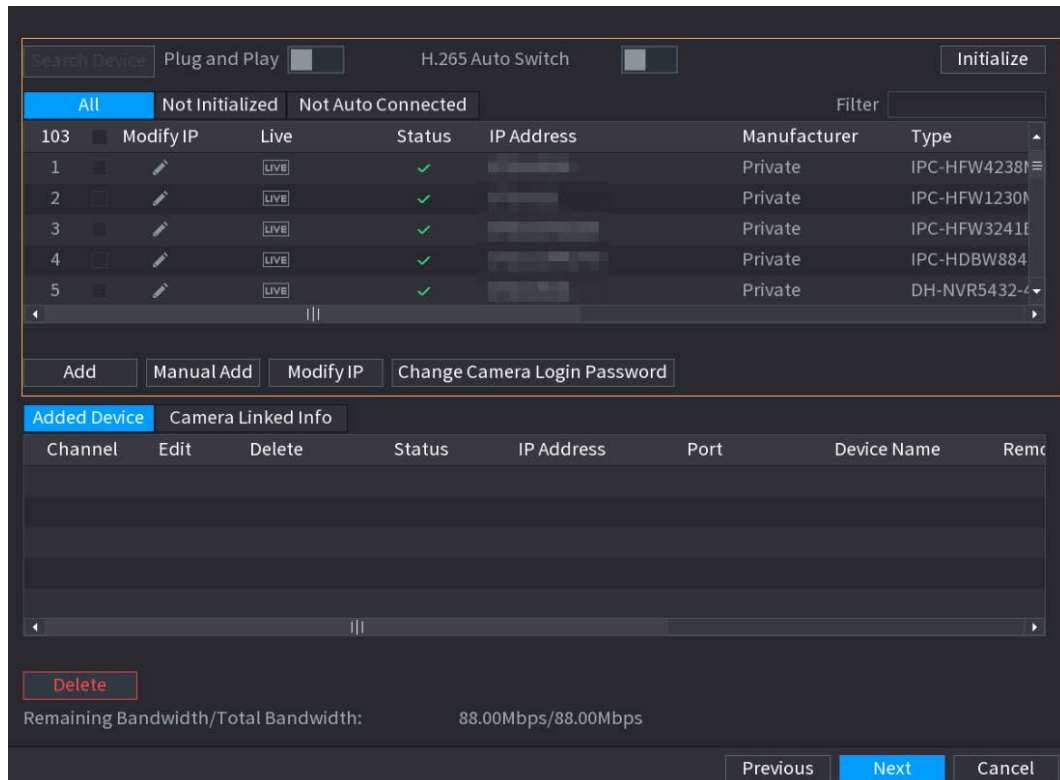

- To view the live image of a camera, click **LIVE** and then enter the username and password. You can only view live images of cameras accessed through private protocol.
- To filter the remote devices, select device name from the **Filter** drop-down list.
- To filter out the uninitialized devices, click the **Not Initialized** tab, and then you can initialize the devices remotely.
- To view all remote devices added through plug and play, click the **Not Auto Connected** tab. You can remove devices added through plug and play, and they can be automatically added again after plug and play is enabled.

2) (Optional) Enable **Plug and Play**.

When **Plug and Play** is enabled, the Device automatically adds cameras on the same LAN.



For uninitialized cameras, the Device automatically initializes them before adding them.

3) Enable **H.265 Auto Switch**

When **H.265 Auto Switch** is enabled, the video compression standard of added remote devices is switched to H.265 automatically.

4) Double-click a camera, or select a camera and then click **Add** to register it to the **Added Device** list.

5) Click **Next**.

Step 5 Manage HDD. You can view HDD name, physical position, health status, capacity, and more.



- To configure read/write property, select an option from the **Properties** drop-down list.
- To format an HDD, select the HDD, and then click **Format**.

Figure 5-8 Manage HDD

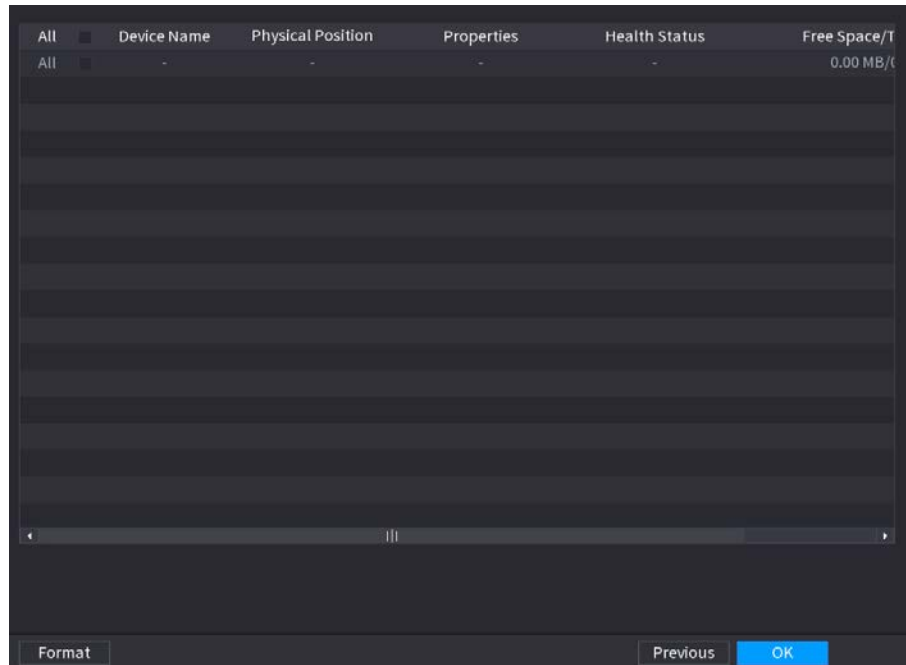

Step 6 Click **OK**.

When the Device prompts whether to restart, click **OK**. The configurations through startup wizard take effect after the Device restarts.

5.3 Login

Background Information

Log in to the Device to perform local operations.

Procedure

Step 1 Right-click the live page, and then click the shortcut menu.

- If you have configured unlock pattern, the unlock pattern login window is displayed. Click **Forgot Pattern** to switch to password login.
- If you did not configure unlock pattern, the password login window is displayed.

Figure 5-9 Unlock pattern login

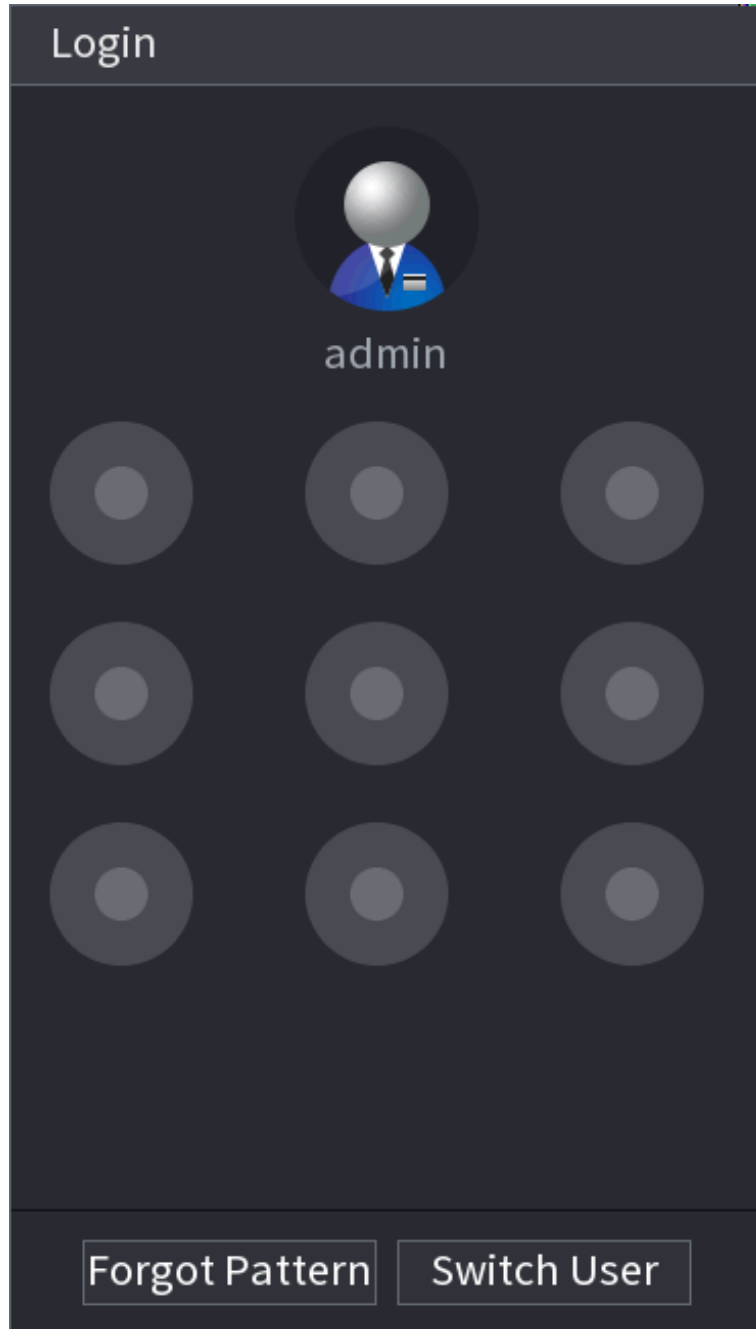
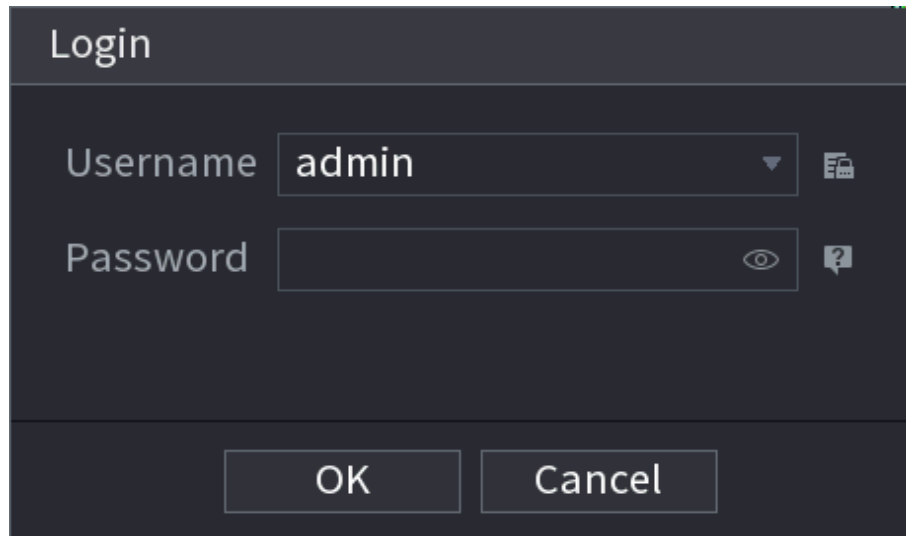

Figure 5-10 Password login



Login

Username admin

Password

OK Cancel

Step 2 Draw unlock pattern, or enter password and then click **OK**.

5.4 Main Menu

After login, right-click the live page, and then click **Main Menu**.

Figure 5-11 Main menu

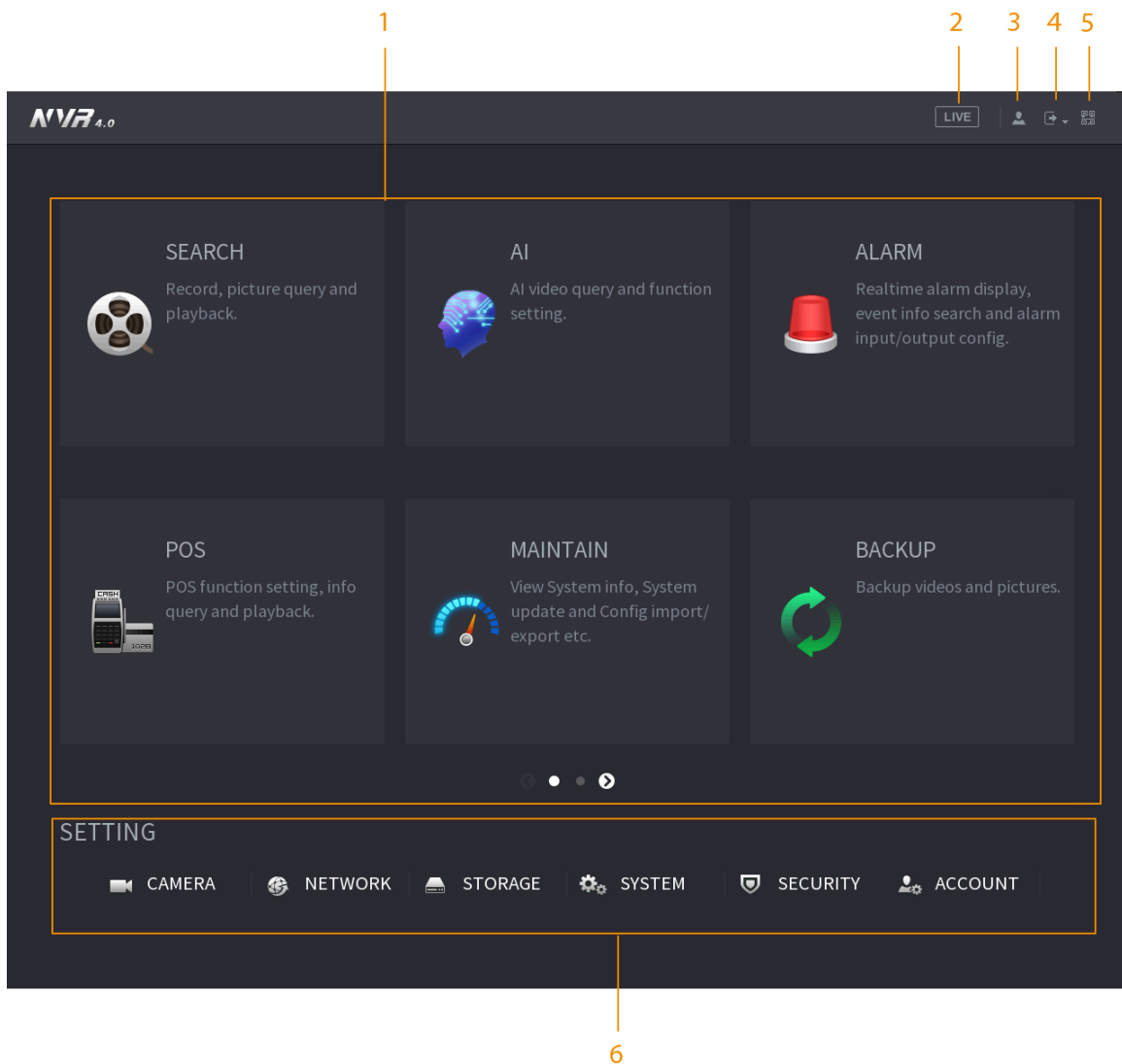

Table 5-4 Main menu description

No.	Description
1	Click each tile to open the corresponding configuration page.
2	Go back to live view.
3	Point to the icon to view the current username.
4	Log out of, restart, or shut down the Device.
5	Click the icon to get the QR codes of mobile client and device SN. You can add the Device to the mobile client for remote management.
6	Configure the settings of camera, network, storage, system, security and account.

5.5 Quick Operation Bar

You can click the icons on the main menu to go to the corresponding configuration page. After that,

you can go to other function tiles or setting item through the quick operation bar.

This section uses **ALARM** and **CAMERA** as examples to show how to quickly access other modules.

Shortcut Icons on Function Titles

Click **ALARM** to go to the **ALARM** page.

Figure 5-12 Quick operation bar (1)

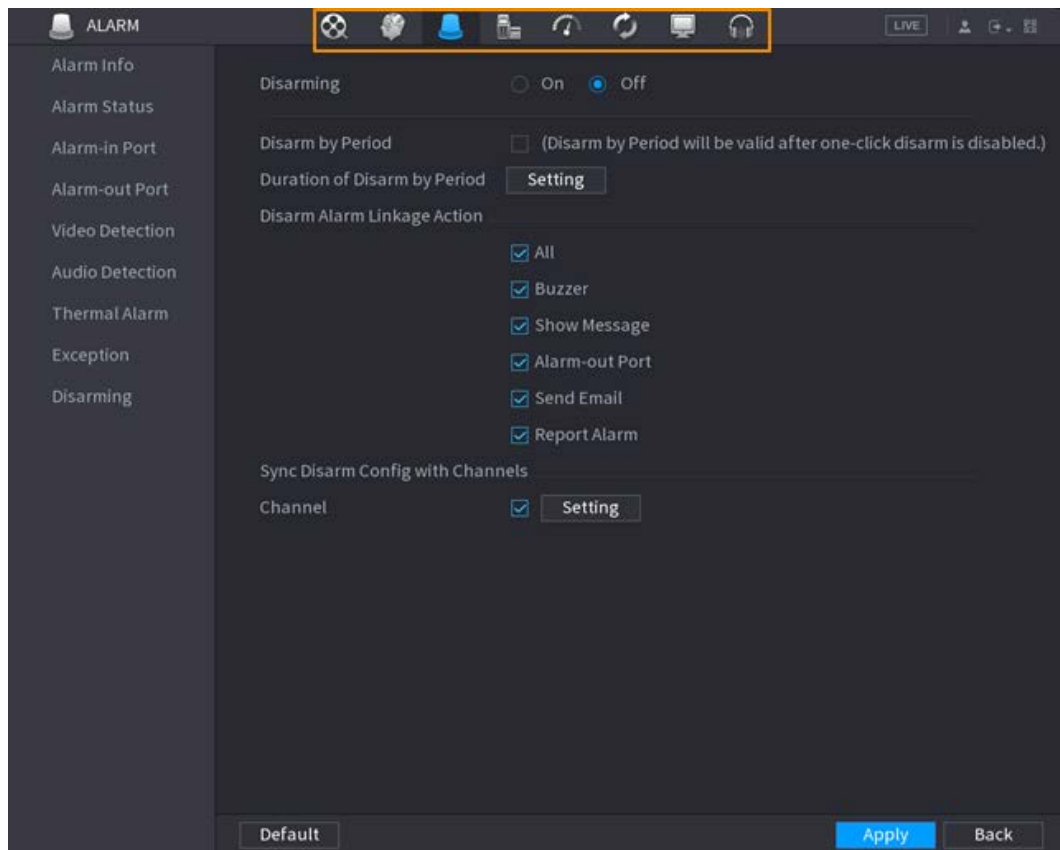

Table 5-5 Quick operation bar description (1)

Icon	Description
	Go to the SEARCH page.
	Go to the ALARM page.
	Go to the AI page.
	Go to the POS page.
	Go to NETWORK page.
	Go to the MAINTAIN page.
	Go to the BACKUP page.
	Go to the DISPLAY page.
	Go to the AUDIO page.

Shortcut Icons on Setting Menu

Click **CAMERA** to go to the **CAMERA** page.

Figure 5-13 Quick operation bar (2)

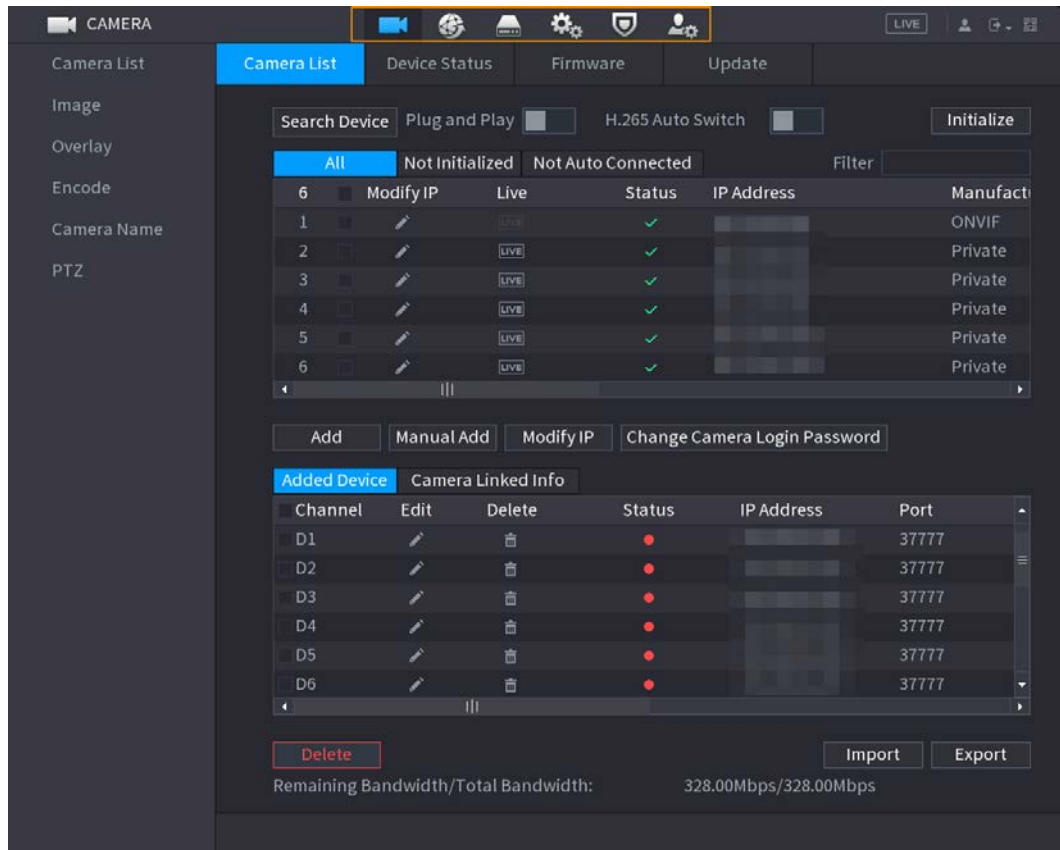

Table 5-6 Quick operation bar description (2)

Icon	Description
	Go to the CAMERA page.
	Go to the NETWORK page.
	Go to the STORAGE page.
	Go to the SYSTEM page.
	Go to the SECURITY page.
	Go to the ACCOUNT page.

5.6 Live View

After you logged in, the system goes to multiple-channel live view mode by default. You can view the live video of each channel.



The number of window splits might vary depending on the model you are using.

5.6.1 Live Page

On the live view page, you can view the live video of each channel. The corresponding channel displays date, time, and channel name after you overlay the corresponding information.

Table 5-7 Icon description

No.	Icon	Description
1		The current channel is recording.
2		Motion detection alarm occurs.
3		Video loss alarm occurs.
4		The current channel is in monitor lock status.
5		The Device connects to the network camera remotely. This function is available on select models.

5.6.2 Navigation bar

Background Information

You can quickly perform operations through the icons on the navigation bar.



The navigation bar might vary with models.

Procedure

- Step 1** After login, right-click the live page, and then select **Main Menu**.
- Step 2** Select **System > General > Basic**.
- Step 3** Click to enable navigation bar.
- Step 4** On the live page, click any position and then the navigation appears at the bottom.

Figure 5-14 Navigation bar



Table 5-8 Navigation bar description

Icon	Function
	Open Main Menu .
	Expand or condense the navigation bar.
	Select view layout.
	Go to the previous screen.
	Go to the next screen.
	Enable tour function. The icon switches to If you close the tour or the triggered tour operation has canceled, the Device restores the previous preview video.
	Open the PTZ control panel. For details, see "5.6.7.2 PTZ Control".

Icon	Function
	Configure image settings. For details, see "5.7.4 Configuring Image Settings". This function is supported only in single-channel layout.
	Search for records. For detail, see "5.8.2.1 Search Page".
	Open the Voice Broadcast page. For detail, see "5.18.3 Broadcast".
	Open the Alarm Status interface to view the device alarm status. For details, see "5.10.2 Alarm Status".
	Open the Channel Info interface to display the information of each channel.
	Open the Add Camera page..
	Open the NETWORK page. For details, see "5.19.3 Network".
	Open the Disk Manager page. For details, see "5.12.2 Disk Manager".
	Open the USB Management page. You can view USB information, back up files, and update the system.
	Switch to the sub screen.

5.6.3 Live View Control Bar

Point to the top center of the video of current channel; and then the live view control bar appears. If your mouse stays in this area for more than 6 seconds and has no operation, the control bar automatically hides.



- Disable the navigation bar before using this function.
- The live view control bar is different depending on the model.

Figure 5-15 Live view control bar

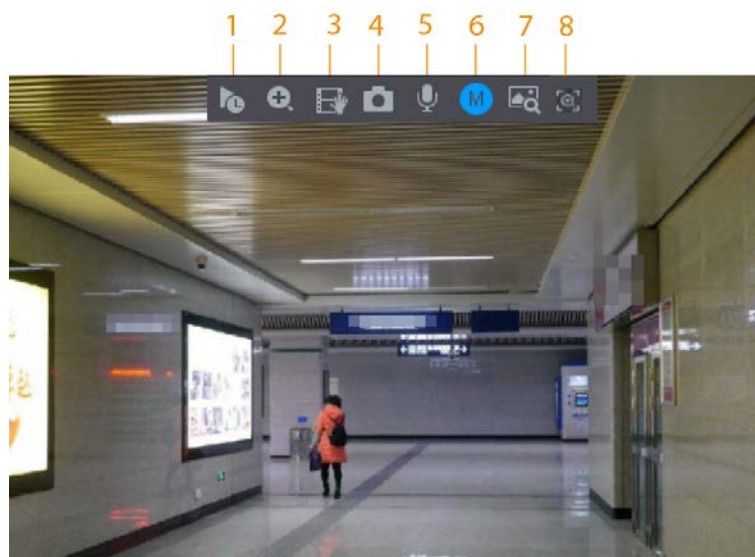

Table 5-9 Live view control bar description

No.	Name	No.	Name
1	Instant playback.	5	Two-way talk.
2	Digital zoom.	6	Stream switch.
3	Instant backup.	7	Picture search.
4	Manual snapshot.	8	Quick pick.

5.6.3.1 Instant Playback

You can play back the previous 5-60 minutes record of current channel.

Click  for instant playback.

Figure 5-16 Instant playback

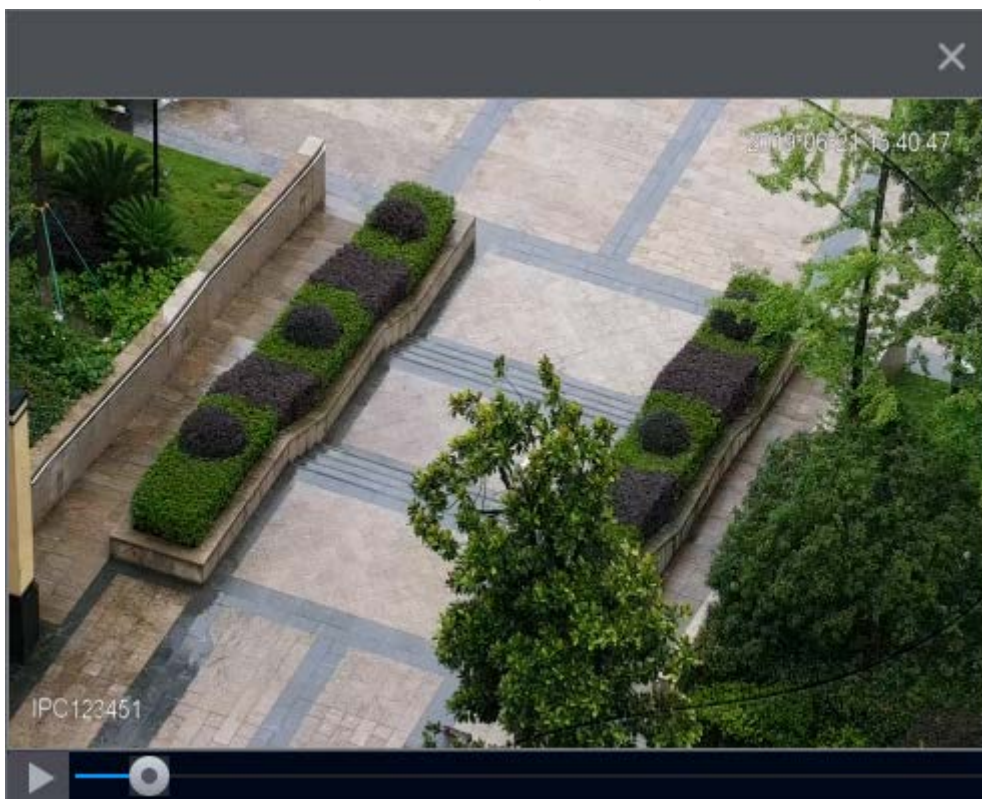

- Move the slider to choose the time you want to start playing.
- You can start, pause and close playback.
- The information such as channel name and recording status icon are shielded during instant playback and will not display until you exit playback.
- During playback, screen split layout switch is not allowed.
- Tour has high higher priority than the instant playback. The instant playback function is not available when tour function is in process and the live view control bar automatically hides either. The function becomes available again after tour ends.



Go to the **Main Menu > SYSTEM > General > Basic** to set instant playback time.

5.6.3.2 Digital Zoom

You can zoom in a specified zone of the current channel to view details. The system supports multi-channel zoom. You can use the digital zoom in the following two ways:

- Click . The icon switches to . Select an area. The area is enlarged after you release the mouse button.



For some models, when the image is enlarged in this way, the selected area is zoomed proportionally according to the window.

- Point to the center that you want to enlarge, and then scroll the mouse to enlarge the area.

When the image is in the enlarged status, you can drag the image toward any direction to view the other enlarged areas. Right-click to cancel zoom and go back to the original video image.

Figure 5-17 Zoom



5.6.3.3 Instant Backup

You can record the video of any channel and save the clip to a USB storage device.

Clicking to start the recording. To stop recording, click this icon again. The clip is automatically saved to the connected USB storage device.

5.6.3.4 Manual Snapshot

You can take one to five snapshots of the video and save to a USB storage device.

Click to take snapshots. The snapshots are automatically saved to the connected USB storage device. You can view the snapshots on your PC.



To change the quantity of snapshots, select **Main Menu > CAMERA > Encode > Snapshot**, in the **Manual Snapshot** list, select the snapshot quantity.



5.6.3.5 Two-way Talk

Background Information

You can perform the voice interaction between the NVR and the remote device to improve efficiency

of emergency.

Procedure

- Step 1 Click  to start two-way talk. The icon changes to . The rest two-way talk buttons of digital channel become dimmed.
- Step 2 Click  again to cancel two-way talk.

5.6.3.6 Stream Switch

Click  to switch the bit stream type of the main stream and sub stream according to current network bandwidth.

- M: Main stream: Its bit streams are big and definition is high. It occupies large network bandwidth suitable for video wall surveillance, storage and more.
- S: Sub stream: Its definition is low but occupies small network bandwidth. It is suitable for general surveillance, remote connection and more. Some models support two sub streams (S1, S2).

5.6.3.7 Picture Search

Background Information

Select the image of target person on the live view page and then search by image for all the related videos with the target person.

Procedure

- Step 1 Click . The live image is frozen.
- Step 2 Draw a search range according to the on-screen prompt, and then click **OK**.



You can adjust the searching area. Make sure that there are less than 30 faces in the selected range.

Figure 5-18 Draw a searching range

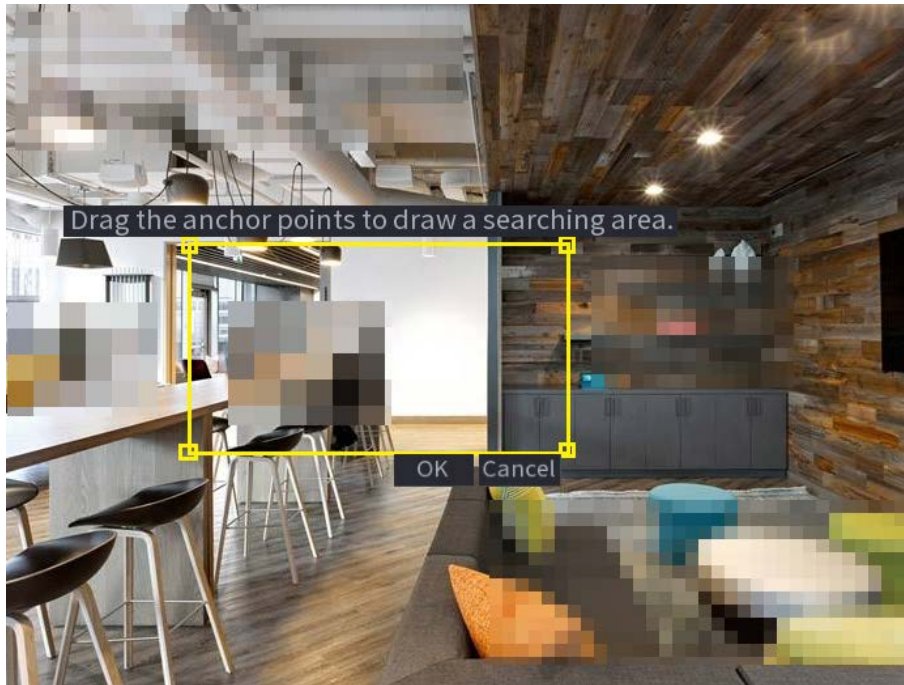



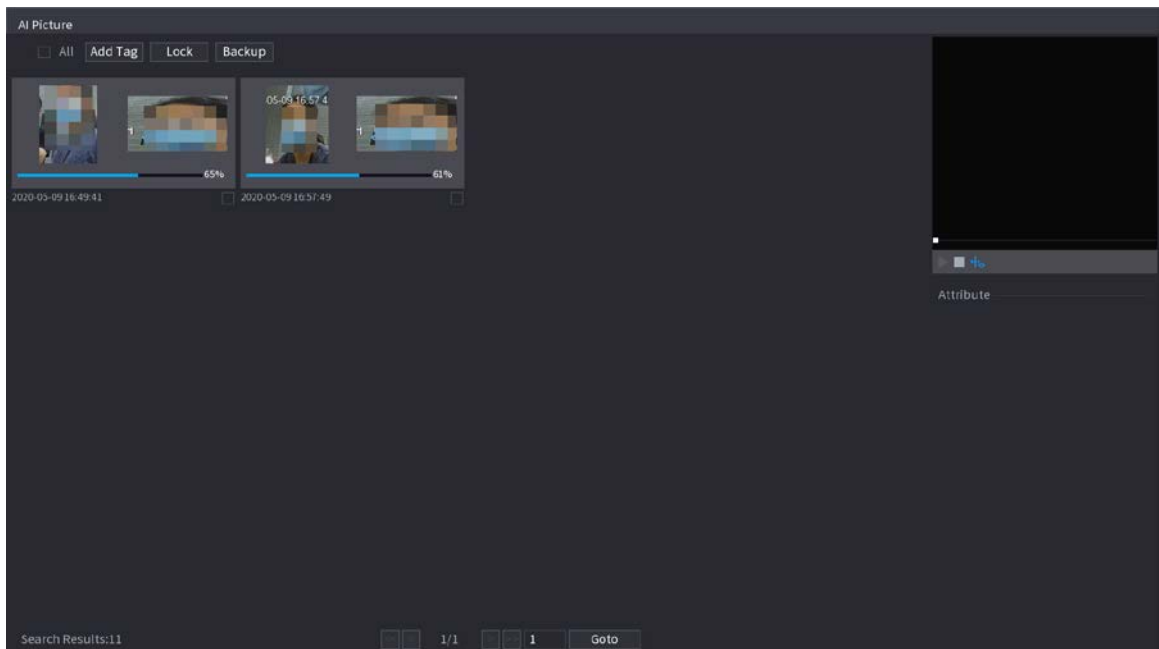

- Step 3 Select the target face that you want to search for. You can select maximum 8 target faces.
- Step 4 Click **Search**. The search results are displayed.

Figure 5-19 Picture search results



Related Operations

- Play video.
Select the picture and then click  to play back the video within 10 seconds before and after the snapshot. During playback, you can

- ◇ Click  to pause.
- ◇ Click  to stop.
- ◇ Click  to display or hide the intelligent rules.
- Add tag.
Select the picture and then click **Add Tag** to add a tag to the recorded video to find the target recorded video more fast.
- Lock recorded video.
If you want to keep the recorded video permanently, select the picture, and then click **Lock**. The locked video cannot be overwritten and deleted.
- Back up recorded video or picture.
Select the picture, and then click **Backup**. You can set save path, backup type, and file type, and then export to the external storage device.

5.6.3.8 Quick Pick

When connected with select IPC cameras, Quick Pick technology becomes available, allowing human and vehicle targets to be easily searched for and picked out.

Procedure

- Step 1 Click  to freeze the live page.
- Step 2 Drag the anchor points to draw a searching area.



You can adjust the searching area. Make sure that there are less than 30 targets in the selected area.

Figure 5-20 Quick pick

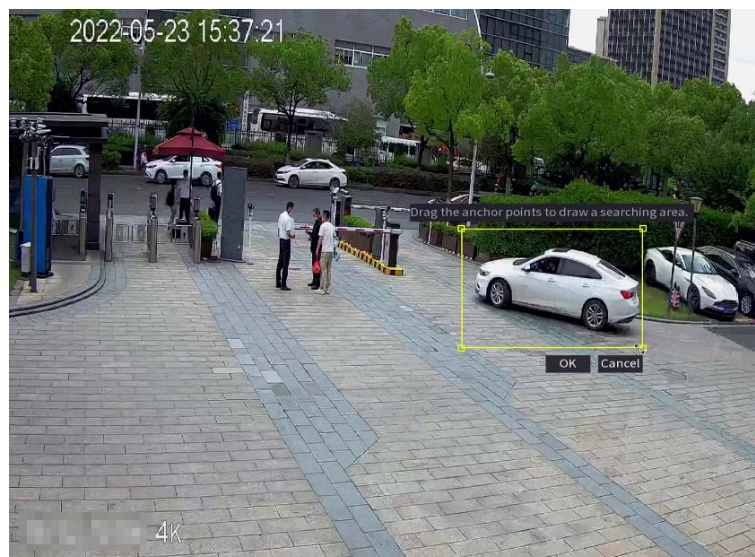

- Step 3 Click **OK**.
The search results are displayed.

Figure 5-21 Search results

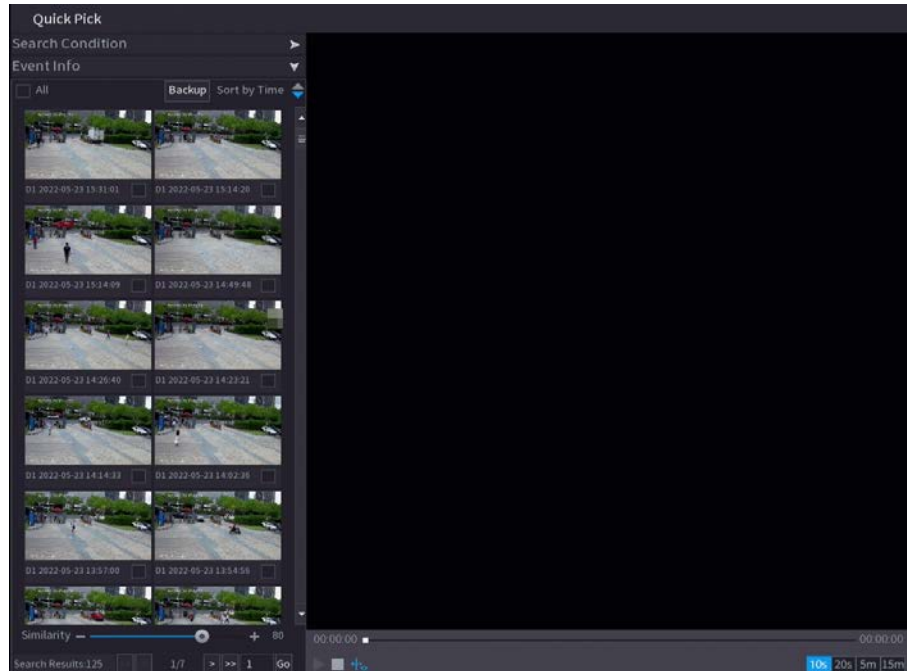

Step 4 (Optional) Click **Search Condition**, change the search conditions, and then click **Search**.



You can only select up to 8 targets for search.

Figure 5-22 Search conditions

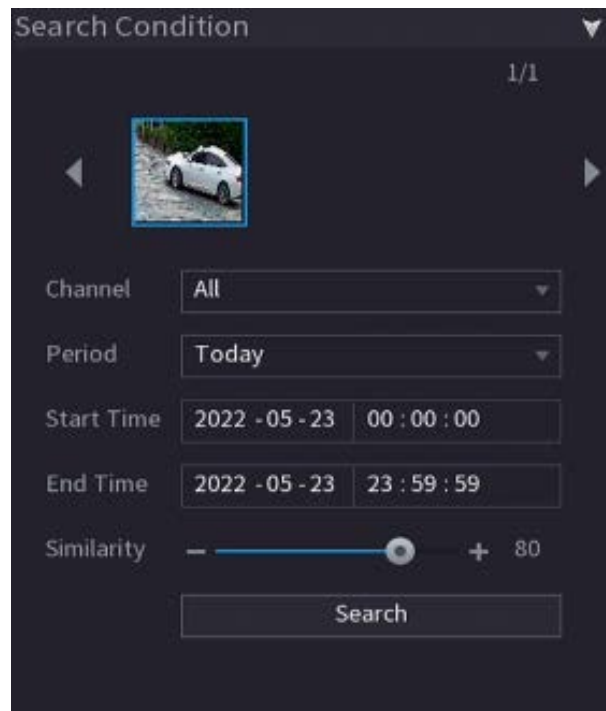

Step 5 Hover over a search result to view the basic information including channel, start time, end time and target type. Double-click a result to play the video.



You can select one or more search results and then click **Backup** to back up the results.

5.6.4 Shortcut Menu

Right-click the live view page to bring up the shortcut menu. You can go to main menu, play back videos or images, configure view split, and configure the settings of PTZ, image, and more.



The shortcut menu is different for different models.

Figure 5-23 Shortcut menu (1)

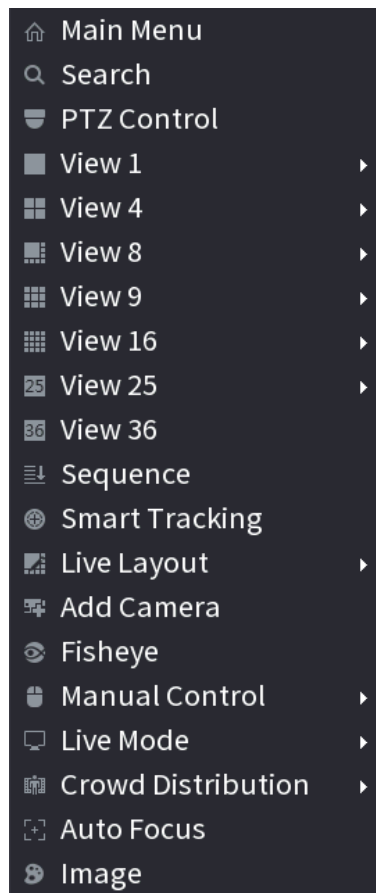

Figure 5-24 Shortcut menu (2)

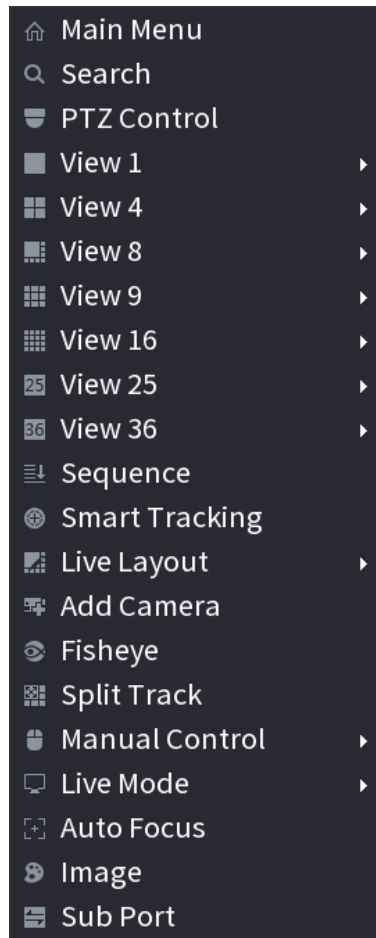

Figure 5-25 Shortcut menu (3)

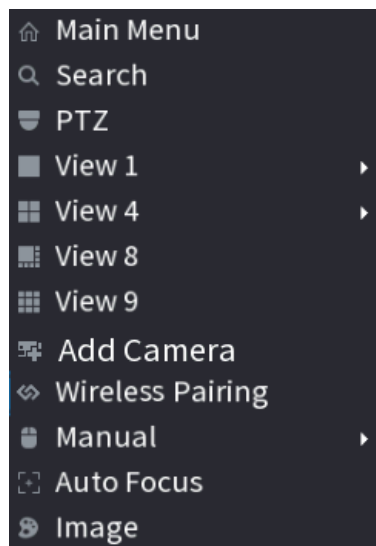



Table 5-10 Shortcut menu description

Function	Description
Main Menu	Go to main menu.
Search	Search and play back videos or images.
PTZ Control	Open the PTZ control panel. For details, see "5.6.7 PTZ".

Function	Description
View 1/4/8/9/16/25/36	Configure the live view screen as a single-channel layout or multi-channel layout.
Sequence	Set customized screen split mode and channels. For details, see "5.6.9 Sequence".
Add Camera	Add cameras to the Device.
Wireless Pairing	Quickly add IPCs. For details, see "5.6.8 Wireless Pairing".
Split Track	Split the screen of a certain channel. For details, see "5.6.6 Split Tracking".
Manual Control	<ul style="list-style-type: none"> • Record Mode: You can configure the recording mode as Auto or Manual, or stop the recording. You can also enable or disable snapshot function • Alarm Mode: You can configure alarm output settings.
Live Mode	Select General or AI Mode . In the AI mode, the information of detected face, human or vehicles are displayed on the right side of the live page.
Crowd Distribution	Select On or Close to enable or disable crowd distribution function.
Auto Focus	Click to realize auto focus function.  Make sure the connected camera supports this function.
Image	Click to modify the camera image parameters. For details, see "5.7.4 Configuring Image Settings".
Sub Screen	Click Sub Screen to switch to the current monitor to the sub screen.
Smart Tracking	Enable smart tracking to track targets manually or automatically.
Mirror Sub Screen	Displays the image of the sub screen on the main screen.

5.6.5 AI Live View Mode

Background Information

When you select AI mode, the system displays information of human face, personnel, vehicle and non-motor vehicle on the right side of the live page, and it supports to play back records and display feature attributes.



You need to enable face detection, body detection, vehicle detection and non-motor vehicle detection to support this function. For details, see "5.9.8.2 Configuring Video Metadata".

Procedure

Step 1 Right-click the live page, and then select **AI Mode** as **Live Mode**.

Figure 5-26 AI live view

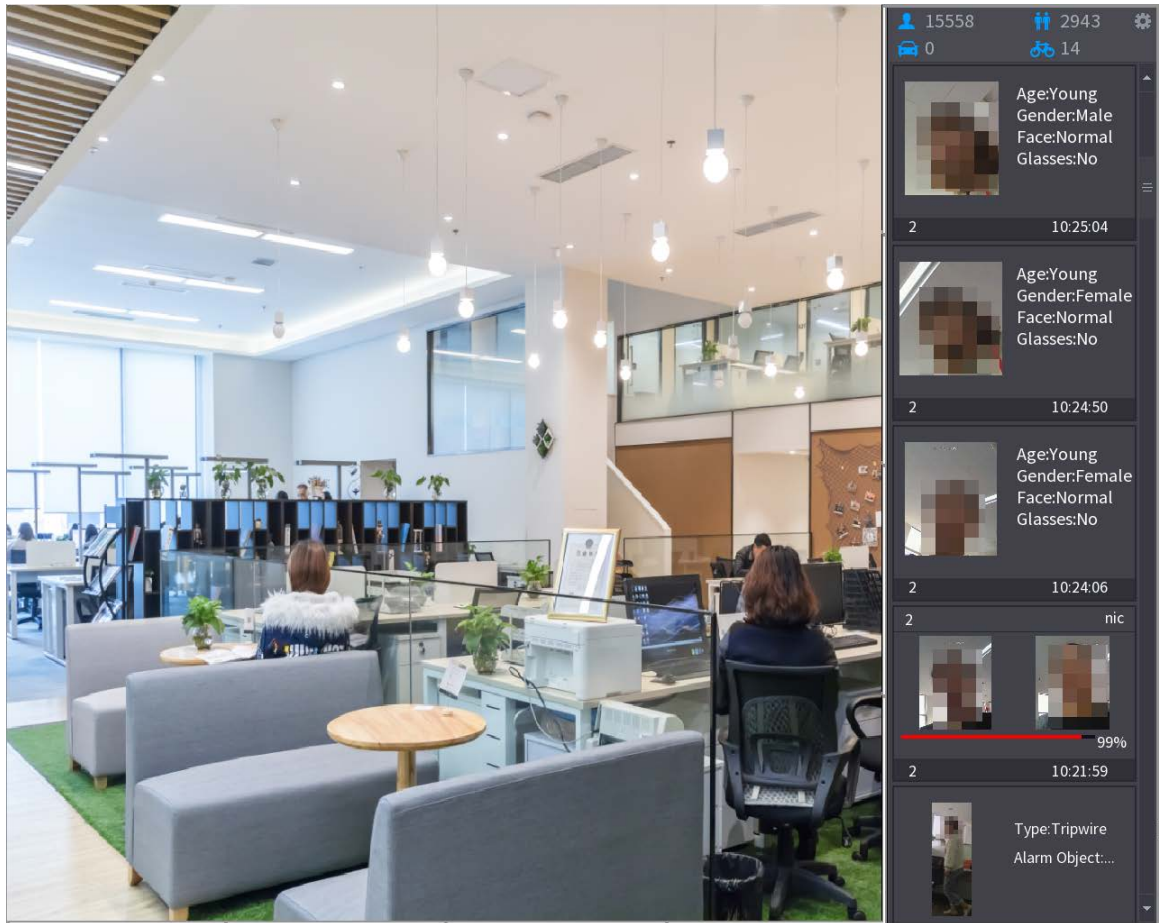

Step 2 (Optional) Double-click the image on the right to play the corresponding video.

Step 3 Click  and then select the face attributes that you want to display. You can select up to four attributes.

Figure 5-27 Face vehicle properties



Step 4 Click **OK**.

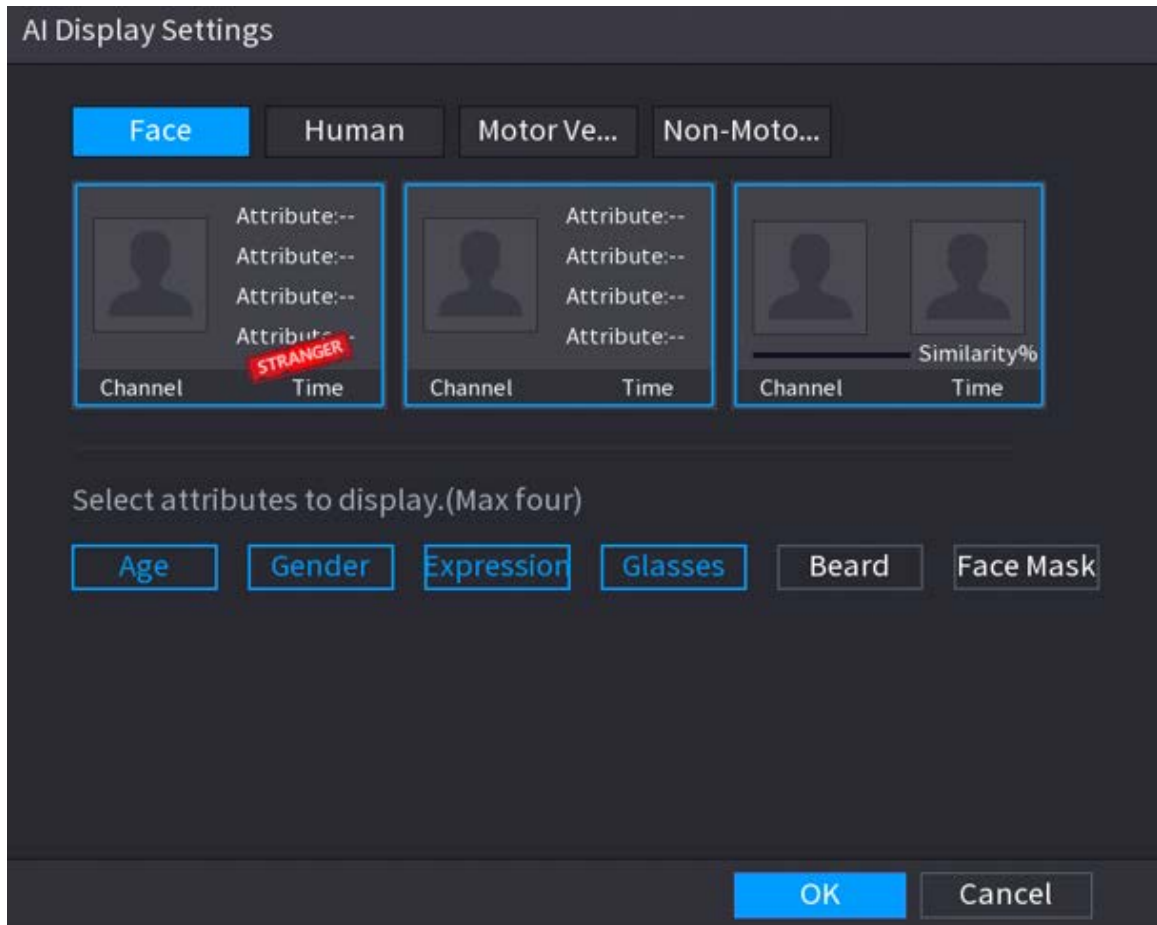

The system can display four attributes at most.

5.6.6 Split Tracking

You can track window split for a certain channel.

Background Information



This function is for select models only.

Procedure

Step 1 Right-click the live page, and then select **Split Track**.

Figure 5-28 Split track

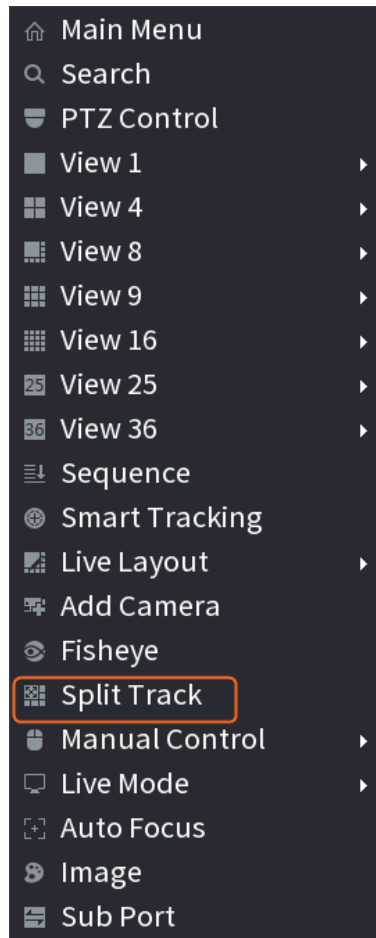

Step 2 Select a split mode.

Figure 5-29 Split mode

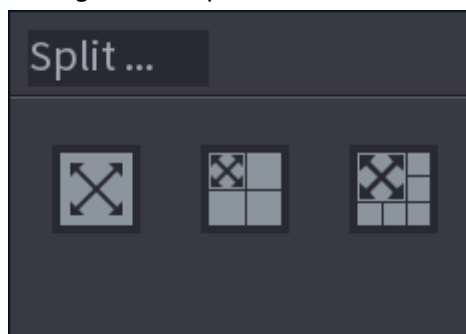

Split mode includes full screen, 1 main screen + 3 split screens and 1 main screen + 5 split screens.

- You can move the rectangles with color to adjust the videos displayed on split screens.
- You can scroll the mouse in split screens to zoom in or out the video.

Figure 5-30 Split display



5.6.7 PTZ

PTZ is a mechanical platform that carries a camera and a protective cover and performs overall control remotely. A PTZ can move in both horizontal and vertical direction to provide all-around view to the camera.



Before you control the PTZ, make sure the PTZ decoder and the NVR network connection is OK.

5.6.7.1 PTZ Settings

Background Information

You can set different PTZ parameters for local type and remote type. Before you use local PTZ, make sure you have set PTZ protocol; otherwise you cannot control the local PTZ.

- Local: The PTZ device connects to the NVR through the cable.
- Remote: The PTZ device connects to the NVR through the network.



This function is available on select models.

Procedure

- Step 1** Select **Main menu > Camera > PTZ**.

Figure 5-31 PTZ (local)

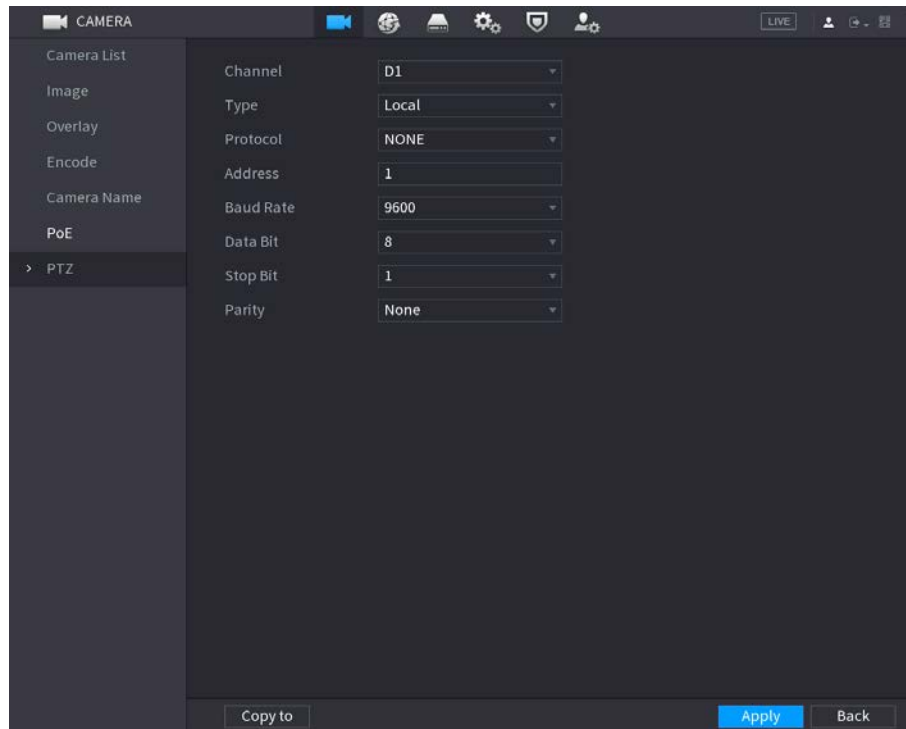
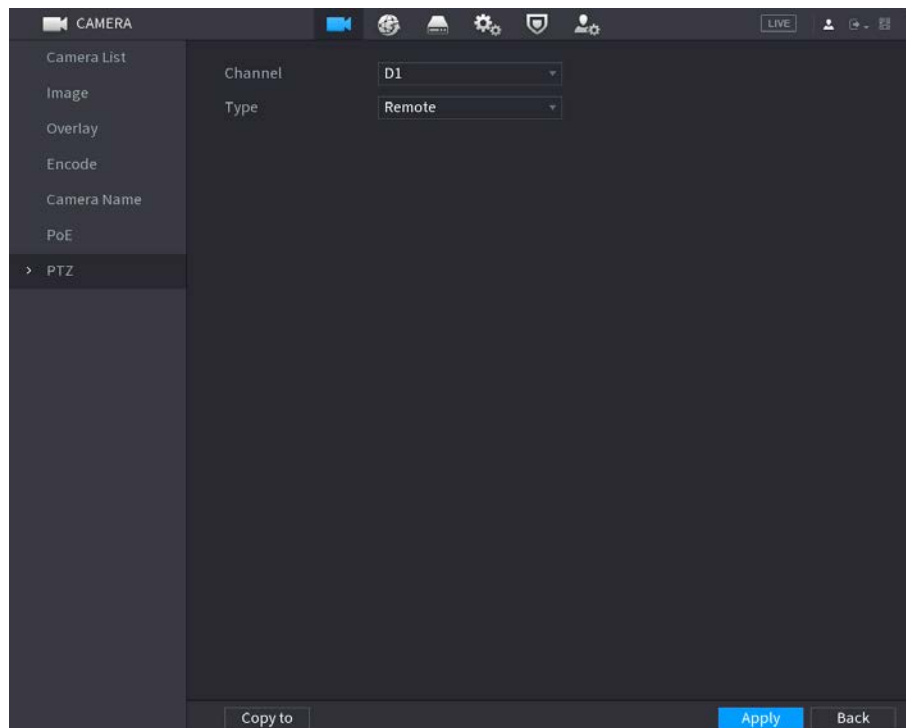



Figure 5-32 PTZ (remote)



Step 2 Configure parameters.

Table 5-11 PTZ parameters

Parameter	Description
Channel	Select the channel that you want to connect the PTZ camera to.
Type	<ul style="list-style-type: none"> Local: Connect through RS-485 port. Remote: Connect through network by adding IP address of PTZ camera to the Device.

Parameter	Description
Protocol	Select the protocol for the PTZ camera such as PELCOD.
Address	Enter the address for PTZ camera. The default is 1.  The entered address must be the same with the address configured on the PTZ camera; otherwise the system cannot control PTZ camera.
Baud rate	Select the baud rate for the PTZ camera. The default is 9600.
Data Bit	The default value is 8.
Stop Bit	The default value is 1.
Parity	The default value is None .

Step 3 Click **Apply**.

5.6.7.2 PTZ Control

You can use the PTZ control panel to perform the operations such as directing camera in eight directions, adjusting zoom, focus and iris settings, and quick positioning.

Basic PTZ Control Panel





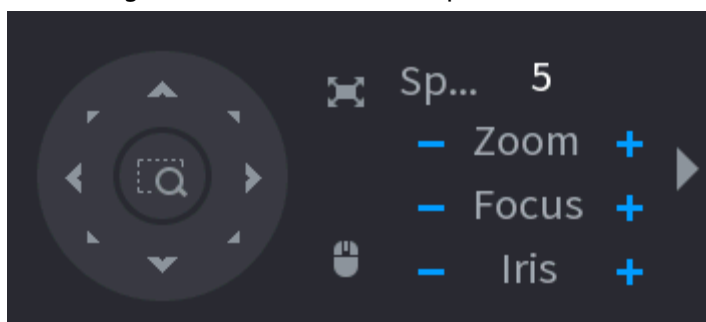

Right-click the live page, and then select **PTZ Control**.





Figure 5-33 Basic PTZ control panel



- The gray button means system does not support current function.
- For some model, the PTZ function is available only in one-window mode.

Table 5-12 PTZ control parameters

Parameter	Description
Speed	Controls the movement speed. The bigger the value, the faster the movement.
Zoom	 : Zoom out.  : Zoom in.
Focus	 : Focus far.  : Focus near.
Iris	 : Image darker.  : Image brighter.

Parameter	Description
PTZ movement	Supports eight directions.
	Fast positioning button. <ul style="list-style-type: none"> Positioning: Click the icon, and the click any point on the live page. The PTZ will turn to this point and locate this point in the center. Zooming: Click the icon, and then drag to draw a square on the view. The square supports zooming. <ul style="list-style-type: none"> Drag upward to zoom out, and drag downward to zoom in. The smaller the square, the larger the zoom effect.  <p>This function is available on select models, and can only be controlled through mouse operations.</p>
	Click the icon, and then you can control the four directions (left, right, up, and down) of PTZ movement through mouse operation.
	Open the expanded PTZ control panel.

Expanded PTZ Control Panel









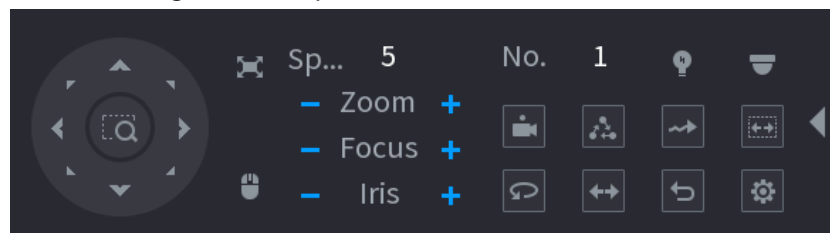

On the basic PTZ control panel, click  to open the expanded PTZ control panel to find more options. See Figure 5-34.

Figure 5-34 Expanded PTZ control bar



- The functions with buttons in gray are not supported by the system.
- Right-click once to return to the interface of PTZ basic control panel.

Table 5-13 PTZ functions

Icon	Function	Icon	Function
	Preset		Pan
	Tour		Flip
	Pattern		Reset
	Scan		Click the AUX Config icon to open the PTZ functions settings interface.
	AUX Switch		Click the Enter Menu icon to open the PTZ Menu interface.

5.6.7.3 Configuring PTZ Functions

5.6.7.3.1 Configuring Presets

Procedure

Step 1 On the expanded PTZ control panel, click .

Figure 5-35 Preset



Step 2 Click the direction arrows to the required position.

Step 3 In the **Preset** box, enter the value to represent the required position.

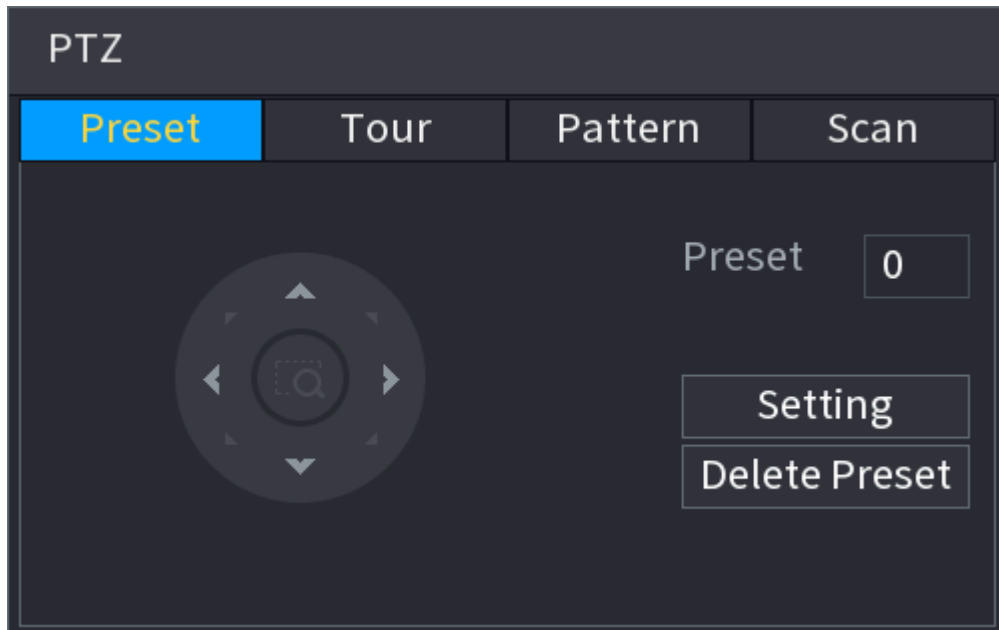
Step 4 Click **Setting** to complete the preset settings.

5.6.7.3.2 Configuring Tours

Procedure

Step 1 On the expanded PTZ control panel, click .

Step 2 Click the **Tour** tab.

Figure 5-36 Tour

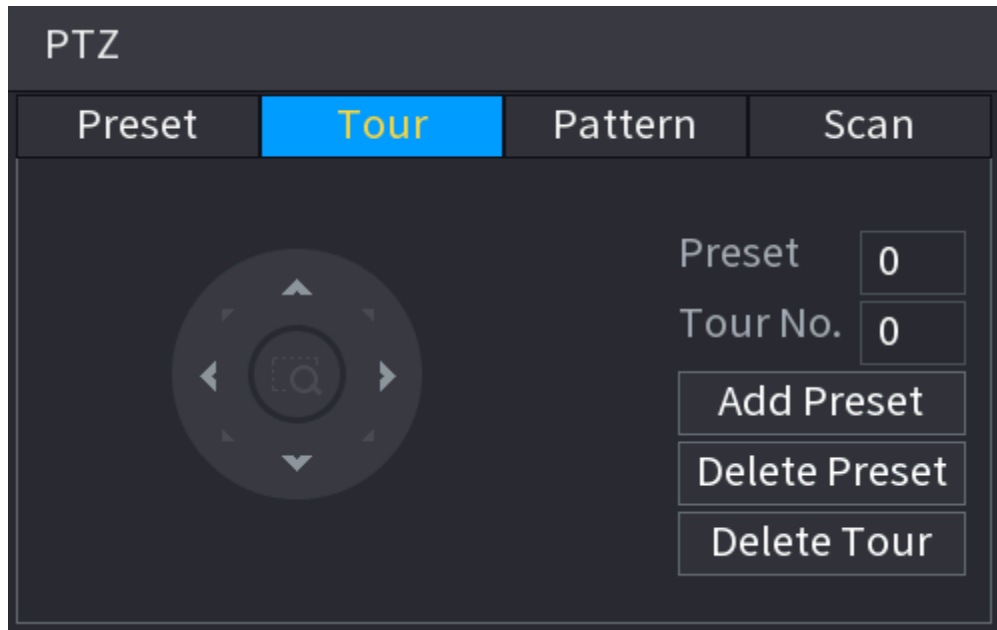

Step 3 In the **Tour No.** box, enter the value for the tour route.

Step 4 In the **Preset** box, enter the preset value.

Step 5 Click **Add Preset**.

A preset will be added for this tour.



- You can repeat adding more presets.
- Click **Delete Preset** to delete the preset for this tour. This operation can be repeated to delete more presets. Some protocols do not support deleting.

5.6.7.3.3 Configuring Patterns

Procedure

Step 1 On the expanded PTZ control panel, click .

Step 2 Click the **Pattern** tab.

Figure 5-37 Pattern

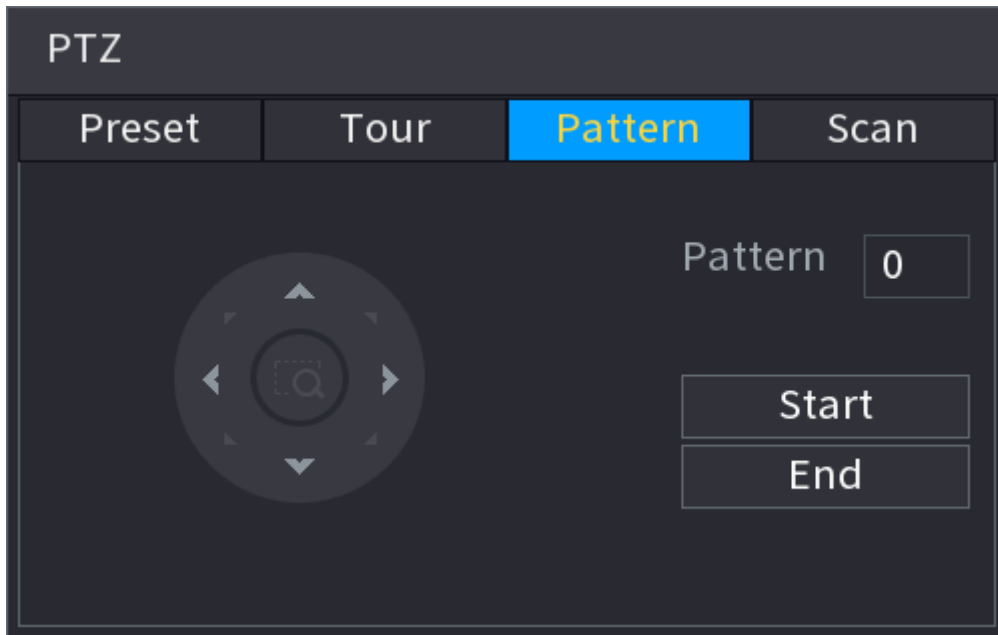

- Step 3 In the **Pattern** box, enter the value for pattern.
- Step 4 Click **Start** to perform the directions operations. You can also go to the PTZ Control Panel to perform the operations of adjusting zoom, focus, iris, and directions.
- Step 5 On the **PTZ** window, click **End** to complete the settings.

5.6.7.3.4 Configuring AutoScan

Procedure

- Step 1 On the expanded PTZ control panel, click .
- Step 2 Click the **Scan** tab.

Figure 5-38 Scan



- Step 3 Click the direction arrows to position the left and right limits.

5.6.7.4 Using PTZ Functions

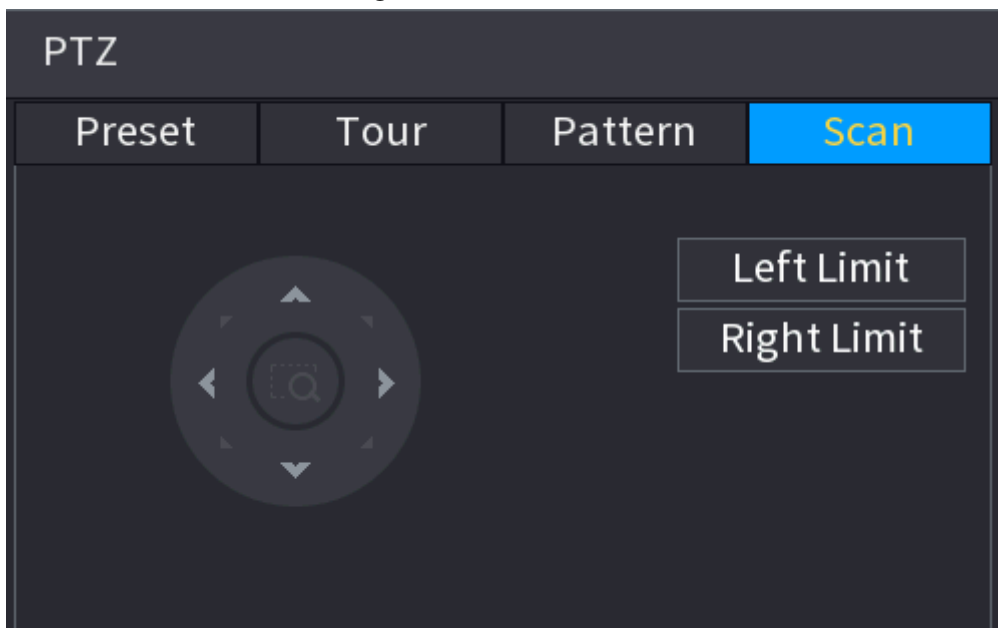

After you have configured the PTZ settings, you can use the PTZ functions from the expanded PTZ control panel.

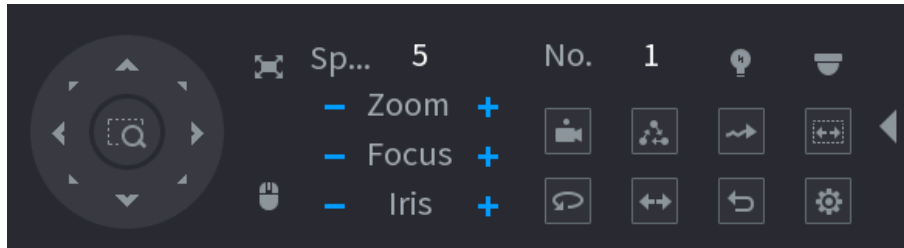
Figure 5-39 Expanded PTZ control panel





5.6.7.4.1 Presets

Procedure

- Step 1 On the expanded PTZ control panel, in the **No.** box, enter the value of the preset.
- Step 2 Click  to call the preset.
- Step 3 Click  again to stop calling the preset.



5.6.7.4.2 Tours

Procedure

- Step 1 On the expanded PTZ control panel, in the **No.** box, enter the value of the tour.
- Step 2 Click  to call the tour.
- Step 3 Click  again to stop calling the tour.



5.6.7.4.3 Patterns

Procedure

- Step 1 On the expanded PTZ control panel, in the **No.** box, enter the value of the pattern.
- Step 2 Click  to call the pattern.
The PTZ camera moves according to the configured pattern repeatedly.
- Step 3 Click  again to stop calling the pattern.



5.6.7.4.4 AutoScan

Procedure

- Step 1 On the expanded PTZ control panel, in the **No.** box, enter the value of the border.
- Step 2 Click .
The PTZ camera performs scanning according to the configured borders.
- Step 3 Click  again to stop auto scanning.

5.6.7.4.5 Calling AutoPan

Procedure

- Step 1** On the expanded PTZ control panel, click  to start moving in horizontal direction.
- Step 2** Click  again to stop moving.

5.6.7.4.6 Auxiliary Button

- On the expanded PTZ control panel, click .
- In the **Shortcut Aux** list, select the option that corresponds to the applied protocol.
- In the **Aux No.** box, enter the number that corresponds to the AUX switch on the decoder.

Figure 5-40 Auxiliary



5.6.8 Wireless Pairing

You can use the wireless pairing to quickly add IPCs to the NVR.

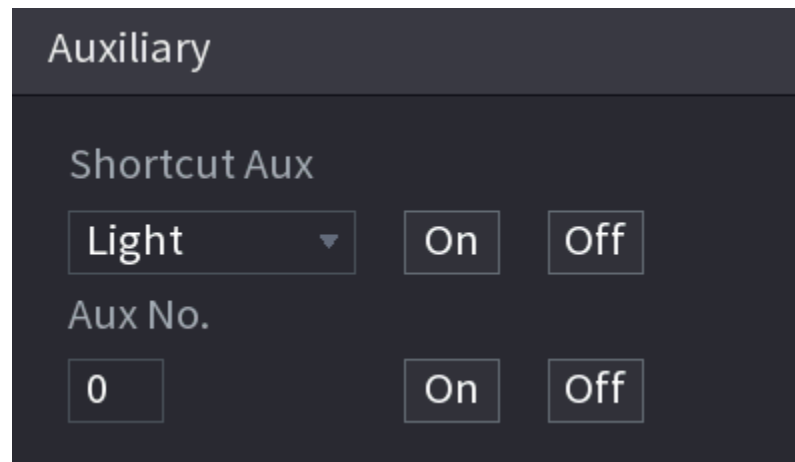

Make sure that the IPC and NVR are on the same network segment.

Right-click the live page, and then select **Wireless Pairing**. The system starts a 120-second pairing countdown. You can see the video of the paired IPC after pairing is successful.

Figure 5-41 Wireless pairing



5.6.9 Sequence

Background Information

You can configure the sequence of the channels displayed on the live page.

Procedure

Step 1 Right-click the live page, and then select **Sequence**.



- After you select **Sequence**, the system automatically switches to the max split amount mode.
- The channel list on the **Sequence** panel displays the added camera channel number and channel name. ● means camera is online. ● means camera is offline.

Figure 5-42 Sequence

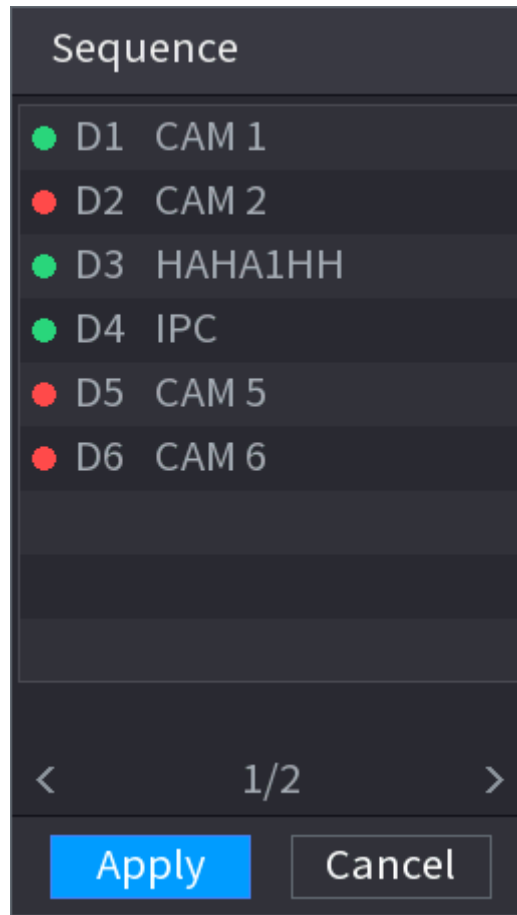

- Step 2 On the **Sequence** panel, drag the channel to the desired window, or drag on the live window to switch the position.
- Check the channel number at the right bottom corner to view the current channel sequence.

Figure 5-43 Channel number

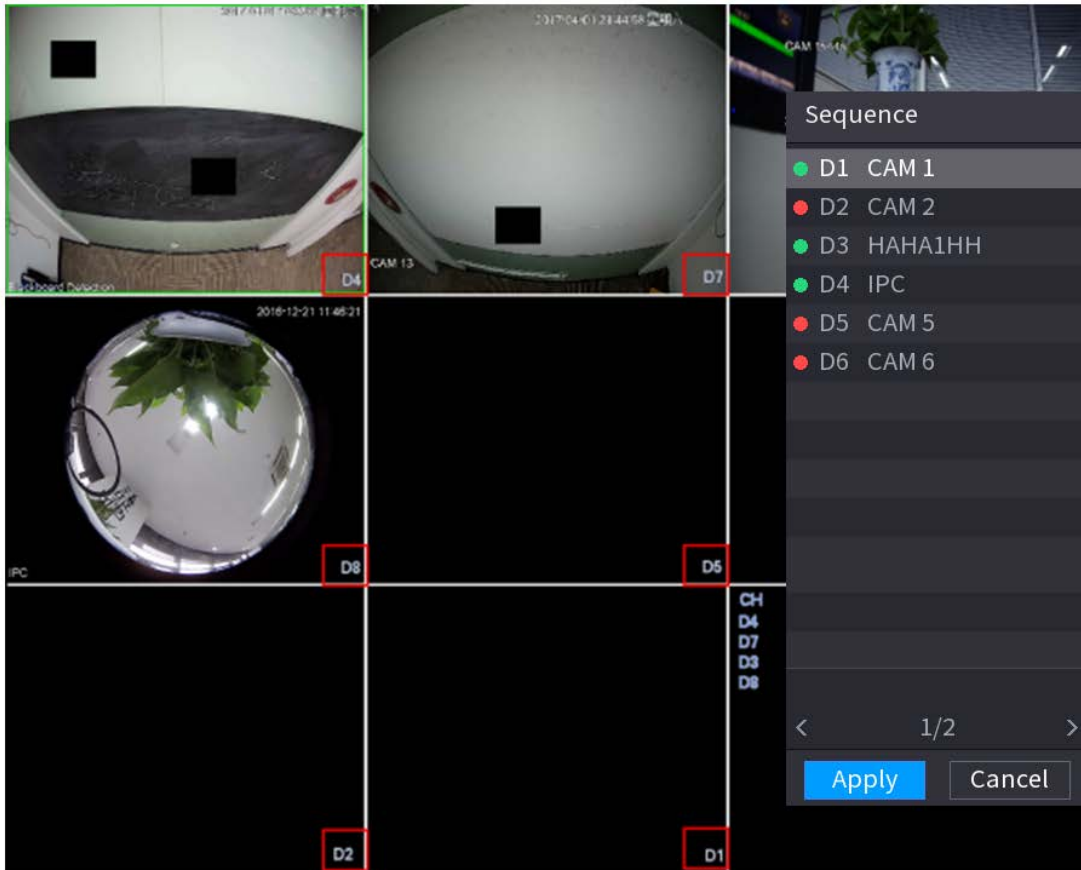

Step 3 Click **Apply**.

After you change the channel sequence, click **Cancel** or right-click the live view page, the system prompts you whether to save the sequence change.

- Click **OK** to save current settings.
- Click **No** to exit without saving the settings.

Figure 5-44 Note for saving sequence

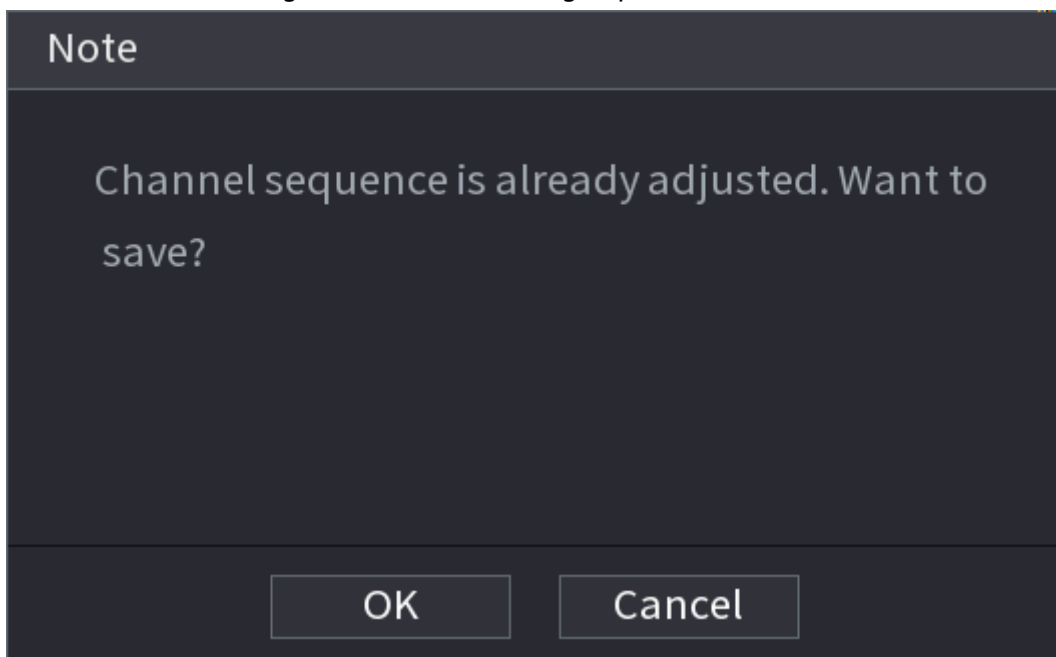

5.6.10 Fisheye

This function is for some models only.

5.6.10.1 Fisheye De-warp on Live View Interface

The fisheye camera (panoramic camera) has wide video of angle but its video is seriously distorted. The de-warp function can present the proper and vivid video suitable for human eyes. On the live page, right-click the fisheye channel, and then select **Fisheye**. You can set fisheye installation mode and display mode.



- For the non-fish eye channel, the system prompts you it is not a fisheye channel and does not support de-warp function.
- If system resources are insufficient, the system prompts you the de-warp function is not available.

Figure 5-45 Fisheye

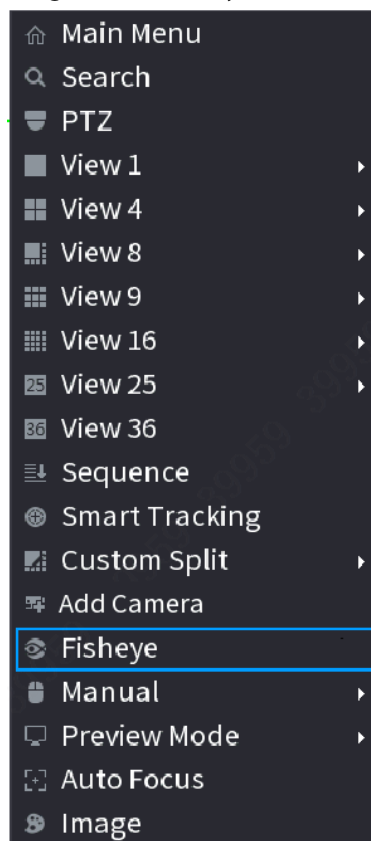

There are three installation modes: ceiling mount, wall mount, and ground mount.



- The different installations modes have different de-warp modes.
- Some models support de-warp of 180° fisheye camera. 180° fisheye camera supports de-warp in wall mount mode only.

Figure 5-46 Fisheye settings

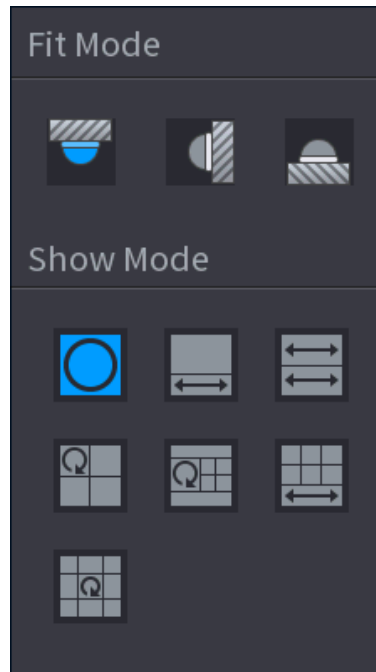

Table 5-14 Installation mode

Installation mode	Icon	Description
(Ceiling mount) (Ground mount)		360° panorama original view
		1 de-warp window+1 panorama stretching
		2 panorama stretching views
		1 360° panorama view+3 de-warp windows
		1 360°panorama view+4 de-warp windows
		4 de-warp windows+1 panorama stretching
		1 360° panorama view+8 de-warp windows
(Wall mount)		360°panorama original view
		Panorama stretching
		1 panorama unfolding view+3 de-warp windows
		1 panorama unfolding view +4 de warp windows
		1 panorama unfolding view +8 de warp windows

Figure 5-47 De-warp



You can adjust the color pane on the left pane or use your mouse to change the position of the small images on the right pane to realize fish eye de-warp.



Operation: Use mouse to zoom in, zoom out, move, and rotate the image (Not for wall mount mode.)

5.6.10.2 Fisheye De-warp During Playback

Background Information

When playing back the fisheye record file, you can use de-warp function to adjust video.

Procedure

- Step 1 On the main menu, click **BACKUP**.
- Step 2 Select 1-window playback mode and corresponding fish eye channel, click  to play.
- Step 3 Right-click , and then you can go to the de-warp playback page. For detailed information, see Figure 5-47.

5.6.11 Temperature Monitoring

Background Information

When NVR connects to the camera that supports temperature detection, the system can display instant temperature.



- This function might collect the human temperature in the surveillance video.
- This function is available on select models.

Procedure

- Step 1 Go to **Main Menu > DISPLAY > Display** to enable the temperature test function.
- Step 2 On the live page, click any position on the thermal channel video. The temperature at the position is displayed.

Figure 5-48 Temperature display

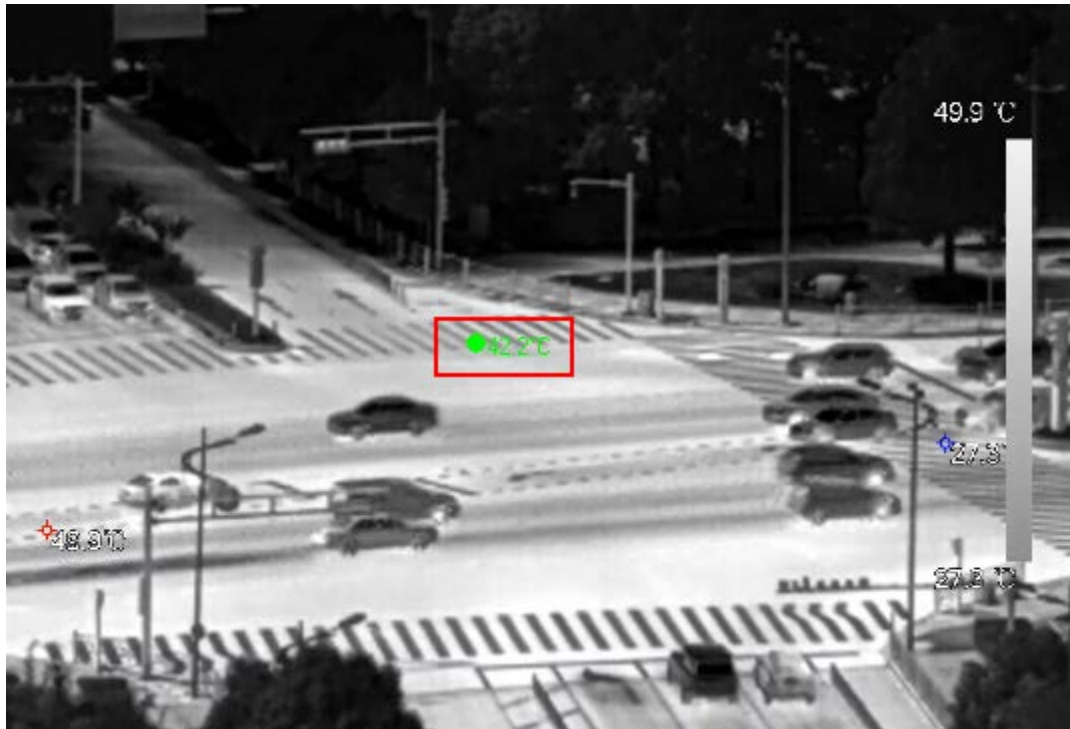

5.6.12 Shortcut Menu to Add Camera

Background Information

You can add cameras on the live page.

Procedure

- Step 1** On the live page, point to a channel window.
There is an icon + on the channel window.

Figure 5-49 Add icon

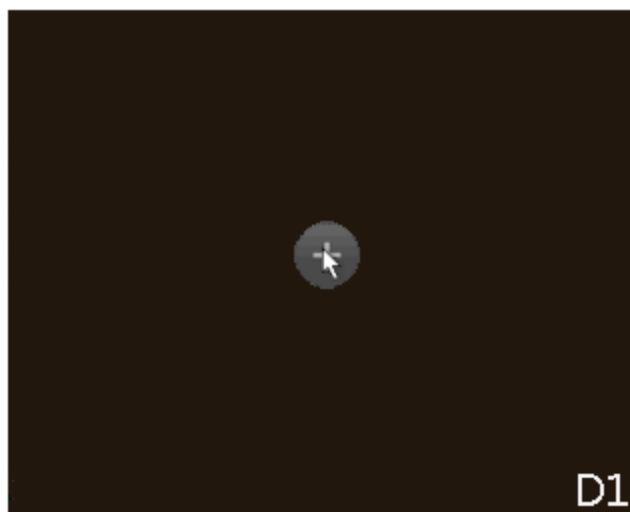

- Step 2** Click "+", and then configure the parameters to add the remote device. For details, see "5.7.2 Adding Remote Devices".

5.6.13 Smart Tracking

Track targets manually or automatically. This function is only available on the multi-sensor panoramic camera + PTZ camera.

Background Information



Make sure that the linked tracking function has been enabled.

Procedure

- Step 1** Right-click the live video, and then select **Smart Tracking**.
- Step 2** Select the tracking method.
- Manual positioning: Click a spot or select a zone on the bullet camera video, and then the PTZ camera will automatically rotate there and zoom in.
 - Manual tracking: Click or select a target on the bullet camera video, and then the PTZ camera automatically rotates and tracks it.
 - Automatic tracking: The tracking action is automatically triggered by tripwire or intrusion alarms according to the pre-defined rules.

5.7 Camera

5.7.1 Initializing Remote Devices

Background Information

You can change the login password and IP address of a remote device when you initialize it.



- When you connect a camera to the NVR via PoE port, NVR automatically initializes the camera. The camera adopts NVR current password and email information by default.
- When you connect a camera to the NVR via PoE port after NVR is upgraded to the new version, the NVR might fail to initialize the camera. You need to initialize the camera manually.

Procedure

- Step 1** Log in to the local system of the Device.
- Step 2** Right-click the live page and then select **Main Menu > CAMERA > Camera List > Camera List**.
- Step 3** Click **Uninitialized**, and then click **Search Device**.
The Device displays cameras to be initialized.
- Step 4** Select a camera to be initialized and then click **Initialize**.

Figure 5-50 Enter password

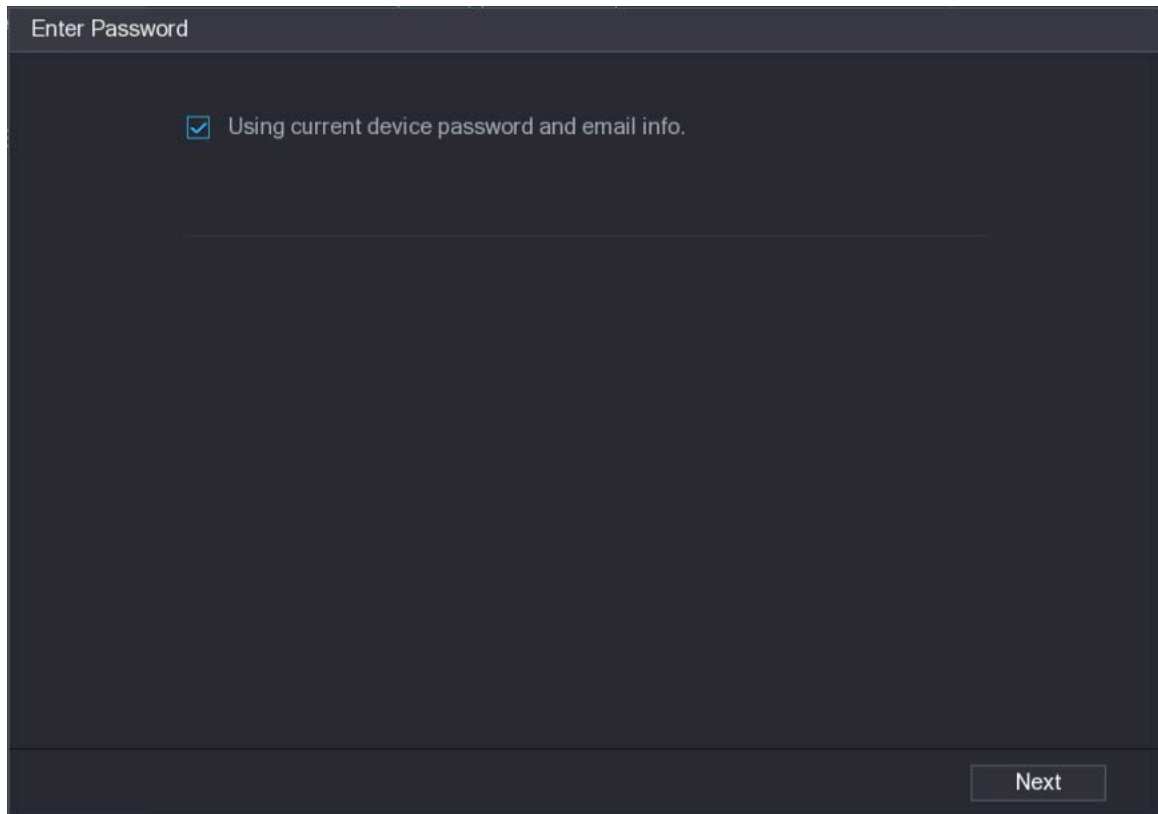

Step 5 Set password and email information for the remote device.



If you select **Using current device password and email info**, the remote device automatically uses NVR admin account information (login password and email). You can skip this step.

- 1) Cancel the selection of **Using current device password and email info**.

Figure 5-51 Password

Enter Password

Using current device password and email info.

User admin

Password

Use a password that has 8 to 32 characters, it can be a combination of letter(s), number(s) and symbol(s) with at least two kinds of them.(please do not use special symbols like ' ' ; : &)

Confirm Password

Next

- 2) Enter the password and then confirm it.



For your device security, we recommend you create a strong password according to the password strength indication and change your password regularly.

- 3) Click **Next**.

Figure 5-52 Password protection

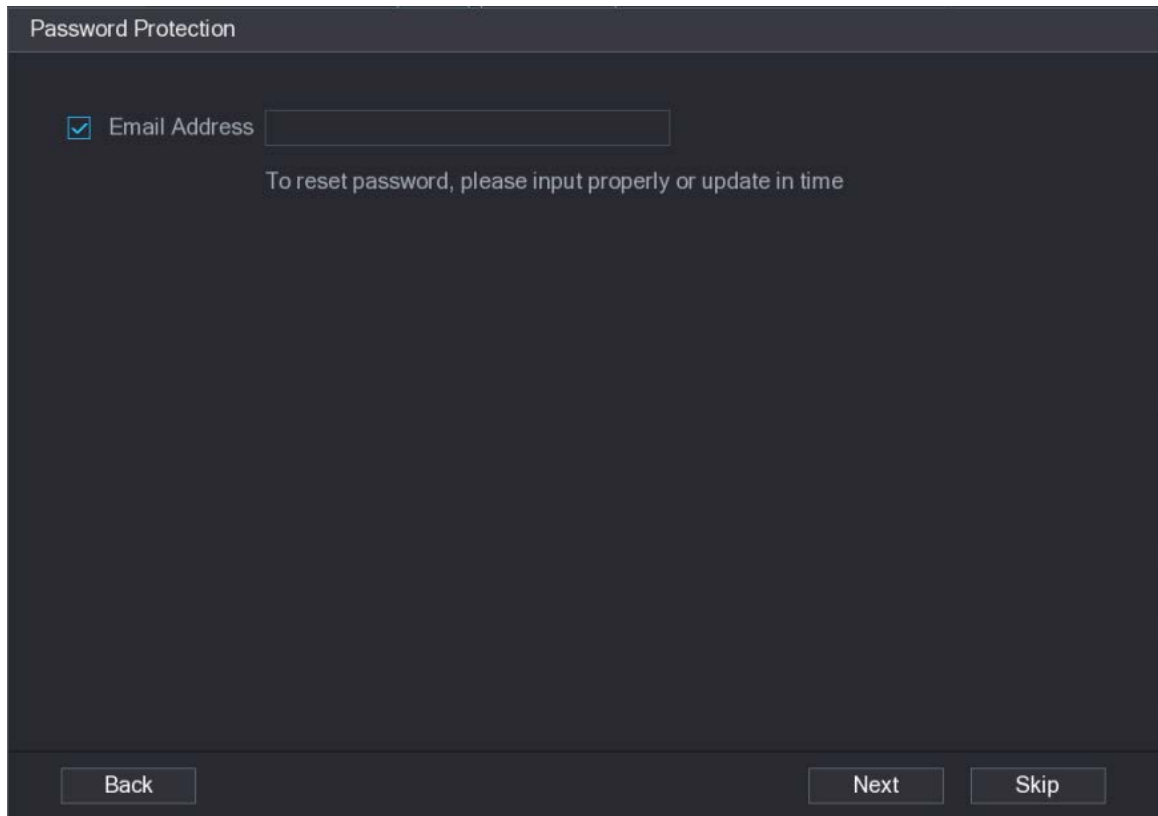

- 4) Enter your email address, and then click **Next**.

The email address is used to receive the security code for password resetting.



If you do not want to enter email information, cancel the selection of the checkbox and then click **Next** or **Skip**.

Step 6 Set camera IP address.

- **DHCP**: There is no need to enter IP address, subnet mask, and default gateway. Device automatically allocates the IP address to the camera.
- **Static**: You need to enter IP address, subnet mask, and default gateway.



- When you are changing IP addresses of several devices at the same time, enter incremental value. The system can add the fourth decimal digit of the IP address one by one to automatically allocate the IP addresses.
- If an IP conflict occurs when you change static IP address, the system will notify you of the issue. If you change IP addresses in batches, the system automatically skips the conflicted IP and begins the allocation according to the incremental value.

Figure 5-53 Modify IP

Modify IP
Checked Device No.: 1

DHCP

STATIC

IP Address

Subnet Mask

Default Gateway

Username

Password

Incremental Value

1	Serial No.	IP Address
1		192.168.1.24

Step 7 Click **Next**.

Figure 5-54 Device initialization

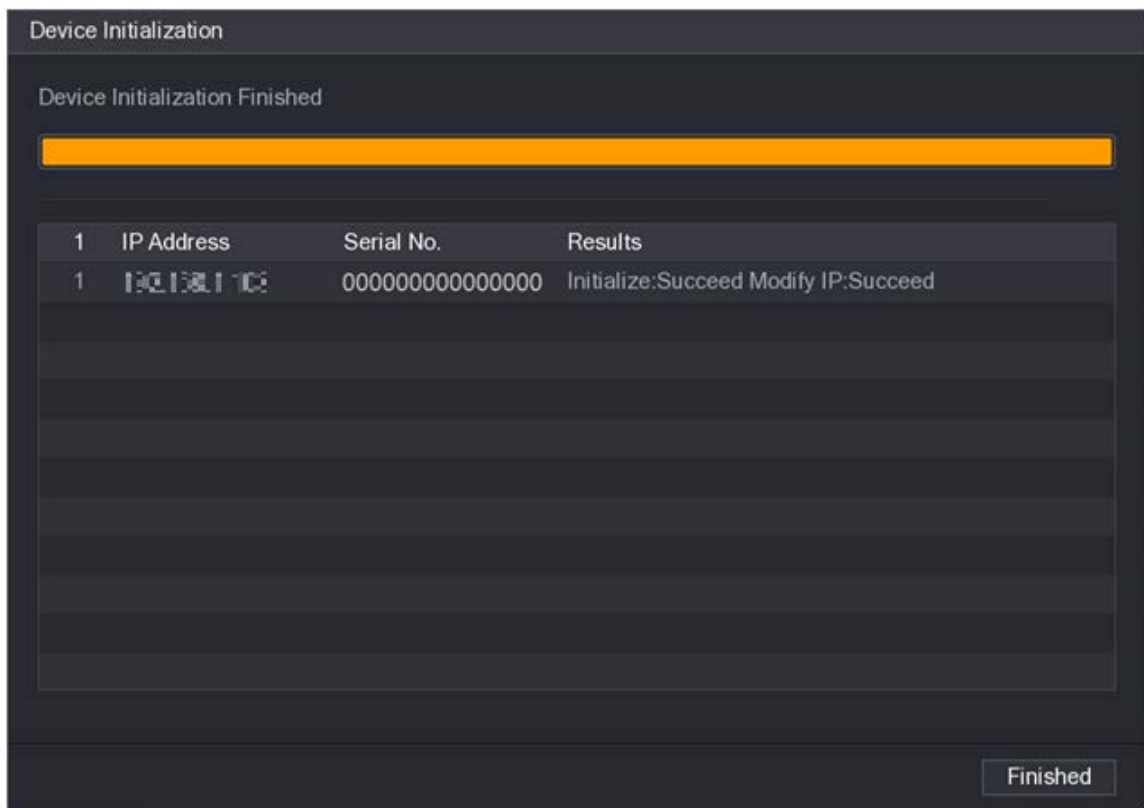

Step 8 Click **Finished**.

5.7.2 Adding Remote Devices

Add remote devices to the NVR to receive, store, and manage the video streams of the remote device.



Before adding the remote devices, make sure that the devices have been initialized.

5.7.2.1 Adding Cameras from Search

Background Information

Search for the remote devices that are on the same network with the NVR, and then add the remote devices from the search results.



We recommend this method when you do not know the specific IP address of the remote device.

Procedure

Step 1 Select **Main Menu > CAMERA > Camera List > Camera List**.

Step 2 Click **Search Device**.

The remote devices found are displayed at the upper pane. Devices already added are not included in the searched results.

Figure 5-55 Search device

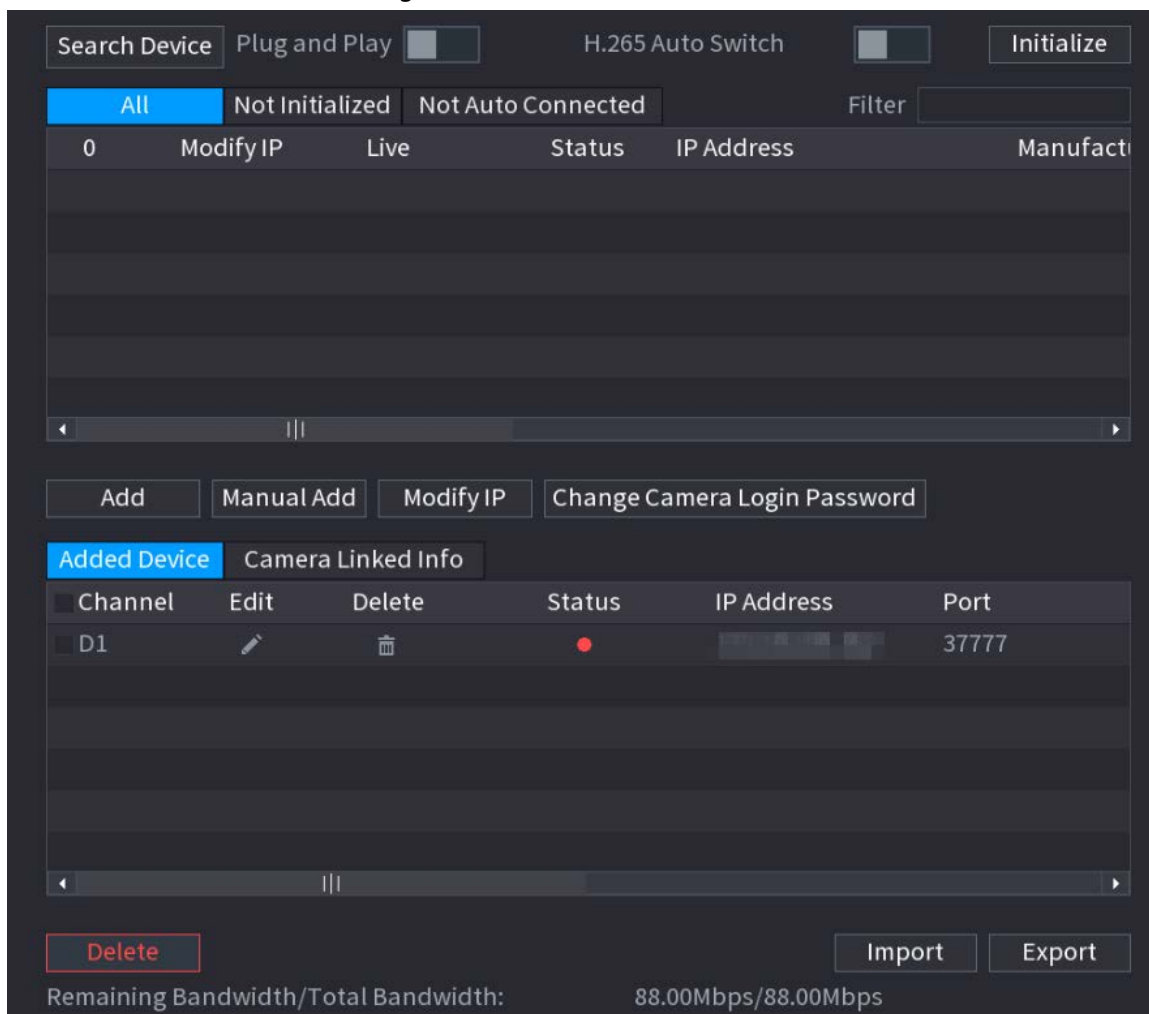

- For cameras accessed through private protocol, you can click **LIVE** and then enter the username and password to play live video.
- To filter the remote devices, you can enter all or part of device name in the **Filter** box.
- To filter out the uninitialized devices, click the **Not Initialized** tab, and then you can initialize the devices. For details, see "5.7.1 Initializing Remote Devices".
- To view all remote devices added through plug and play, you can click the **Not Auto Connected** tab. You can remove devices added through plug and play, and they can be automatically added again after plug and play is enabled.

Step 3 (Optional) Enable **Plug and Play**.

When **Plug and Play** is enabled, the NVR automatically adds remote devices on the same subnet.



For uninitialized remote devices, the NVR automatically initializes them before adding them.



Step 4 (Optional) Enable **H.265 Auto Switch**.



When **H.265 Auto Switch** is enabled, the video compression standard of added remote devices is switched to H.265 automatically.

- Step 5** Double-click a remote device, or select a remote device and then click **Add** to register it to the **Added Device** list.

Related Operations

- Change camera login password.
Select an added camera, and then click **Change Camera Login Password** to change the password.
- Edit camera information.
On the **Added Device** list, click  to change the IP address, username, password and other information.
- Import and export cameras.
You can export the information of the connected cameras and import camera information to the system to add cameras in batches. For details, see "5.7.2.3 Importing Cameras".
- View linked information.
If the remote device has multiple channels, you can click the **Camera Linked Info** to view linked information of the remote device.
- Delete cameras.
 - ◇ Delete one by one.
Click  to delete the corresponding camera.
 - ◇ Delete in batches.
Select one or more cameras, and then click **Delete**.

5.7.2.2 Adding Cameras Manually

Background Information

Configure the IP address, username, password and other information of the remote device manually to add to the NVR.



We recommend this method when you want to add only a few remote devices and know their IP addresses, usernames and passwords.

Procedure

- Step 1** Select **Main Menu > CAMERA > Camera List > Camera List**.
- Step 2** (Optional) Enable **H.265 Auto Switch**.



When **H.265 Auto Switch** is enabled, the video compression standard of added remote devices is switched to H.265 automatically.

- Step 3** Click **Manual Add**.

Figure 5-56 Manual add

Manual Add

Channel	<input type="text" value="D3"/>	▼	
Manufacturer	<input type="text" value="Private"/>	▼	
IP Address	<input type="text" value="192.168.1.1"/>		
TCP Port	<input type="text" value="37777"/>		
Username	<input type="text" value="admin"/>		
Password	<input type="password"/>		<input type="button" value="Connect"/>
Total Channels	<input type="text" value="1"/>		<input type="button" value="Setting"/>
Remote CH No.	<input type="text" value="D1"/>	▼	
Decode Strategy	<input type="text" value="General"/>	▼	

Step 4 Configure the parameters.



The parameters might vary depending on the manufacturer that you select.

Table 5-15 Remote channel parameters

Parameter	Description
Channel	Select the channel that you want use on the Device to connect the remote device.
Manufacturer	Select the manufacturer of the remote device.
IP Address	Enter the IP address of the remote device.
RTSP Port	Enter the RTSP port number. The default value is 554.
HTTP Port	Enter the HTTP port number. The default value is 80.
TCP Port	The default value is 37777. You can enter the value as needed.
Username	Enter the username of the remote device.
Password	Enter the password of the user for the remote device.
Total Channels	Click Connect to get the total number of channels of the remote device.
Remote CH No.	Enter the remote channel number of the remote device.
Decode Strategy	Select Default, Realtime, or Fluent .

Parameter	Description
Protocol Type	<ul style="list-style-type: none"> If the remote device is added through private protocol, the default type is TCP. If the remote device is added through ONVIF protocol, the system supports Auto, TCP, UDP, or MULTICAST. If the remote device is added through other manufacturers, the system supports TCP and UDP.
Encryption	<p>If the remote device is added through ONVIF protocol, select the Encrypt checkbox and then the system will provide encryption protection to the data being transmitted.</p>  <p>To use this function, make sure that the HTTPS function is enabled for the remote IP camera.</p>

Step 5 Click **OK**.

5.7.2.3 Importing Cameras

Background Information

You can import remote devices in batches.



We recommend this method when you want to add lots of remote devices whose IP addresses, usernames and passwords are not the same.

Procedure

Step 1 Select **Main Menu > CAMERA > Camera List > Camera List**.

Step 2 Export the template.



The exported template includes the information of the added remote device. Pay attention to your data security.

1) Click **Export**.

Figure 5-57 Backup encryption

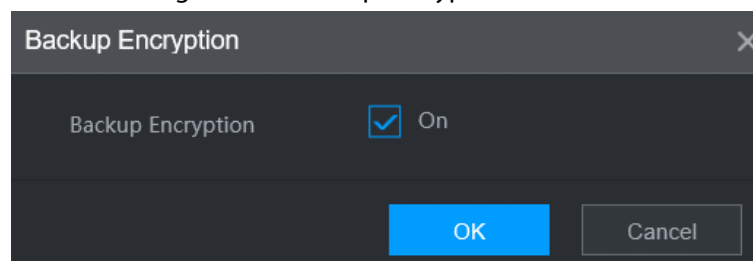

2) Cancel the selection of the **On** checkbox to disable backup encryption, and then click **OK**.



- If **Backup Encryption** is enabled, the file format is .backup.
- If **Backup Encryption** is disabled, the file format is .csv. Keep unencrypted files well to avoid data leakage.

3) Select the storage path and then click **Save**.

- The template file is named RemoteConfig_20220222191255.csv. 20220222191255 represents the export time.
- The template includes the IP address, port, remote channel No., manufacturer, username, password and other information.

Step 3 Fill in the template and then save the file.



Do not change the file extension of the template. Otherwise, the template cannot be imported.

Step 4 Click **Import**, select the template file and then open it.

The remote devices in the template are added to the NVR. If the remote device in the template has been added, the system will prompt you whether to replace the existing one on the device list.

- If you select **Yes**, the system deletes the existing one and import the device again.
- If you select **No**, the system retains the existing one and add the device to another unoccupied channel.

5.7.3 Changing IP Address of Remote Device

The procedures to change the IP addresses of connected and unconnected cameras are different.



You can change the IP address only when the camera is online.

5.7.3.1 Changing IP Address of Connected Remote Device

Procedure

- Step 1 Select **Main Menu > CAMERA > Camera List > Camera List**.
- Step 2 On the **Added Device** list, double-click a remote device or click .
- Step 3 Change the IP address.
- Step 4 Click **OK**.

5.7.3.2 Changing IP Address of Unconnected Cameras

Procedure

- Step 1 Select **Main Menu > CAMERA > Camera List > Camera List**.
- Step 2 Click **Search Device**.
The remote devices found are displayed at the upper pane.
- Step 3 Click  or select one or more remote devices and then click **Modify IP**.



When changing the IP addresses of multiple remote devices at the same time, make sure that they share the same username and password.

- Step 4 Enter username and password of the remote device, and then configure the IP address.
- **DHCP:** The remote device gets a dynamic IP address automatically.
 - **Static:** You need to enter static IP address, subnet mask, and default gateway. When changing IP addresses of multiple remote devices at the same time, enter the incremental value so that the system can add the fourth decimal digit of the IP address one by one according to the incremental value.
- Step 5 Click **OK**.

5.7.4 Configuring Image Settings

Background Information

You can set network camera parameters according to different environments to get the best video effect.

Procedure

- Step 1 Select **Main Menu > CAMERA > Image**.

Figure 5-58 Image

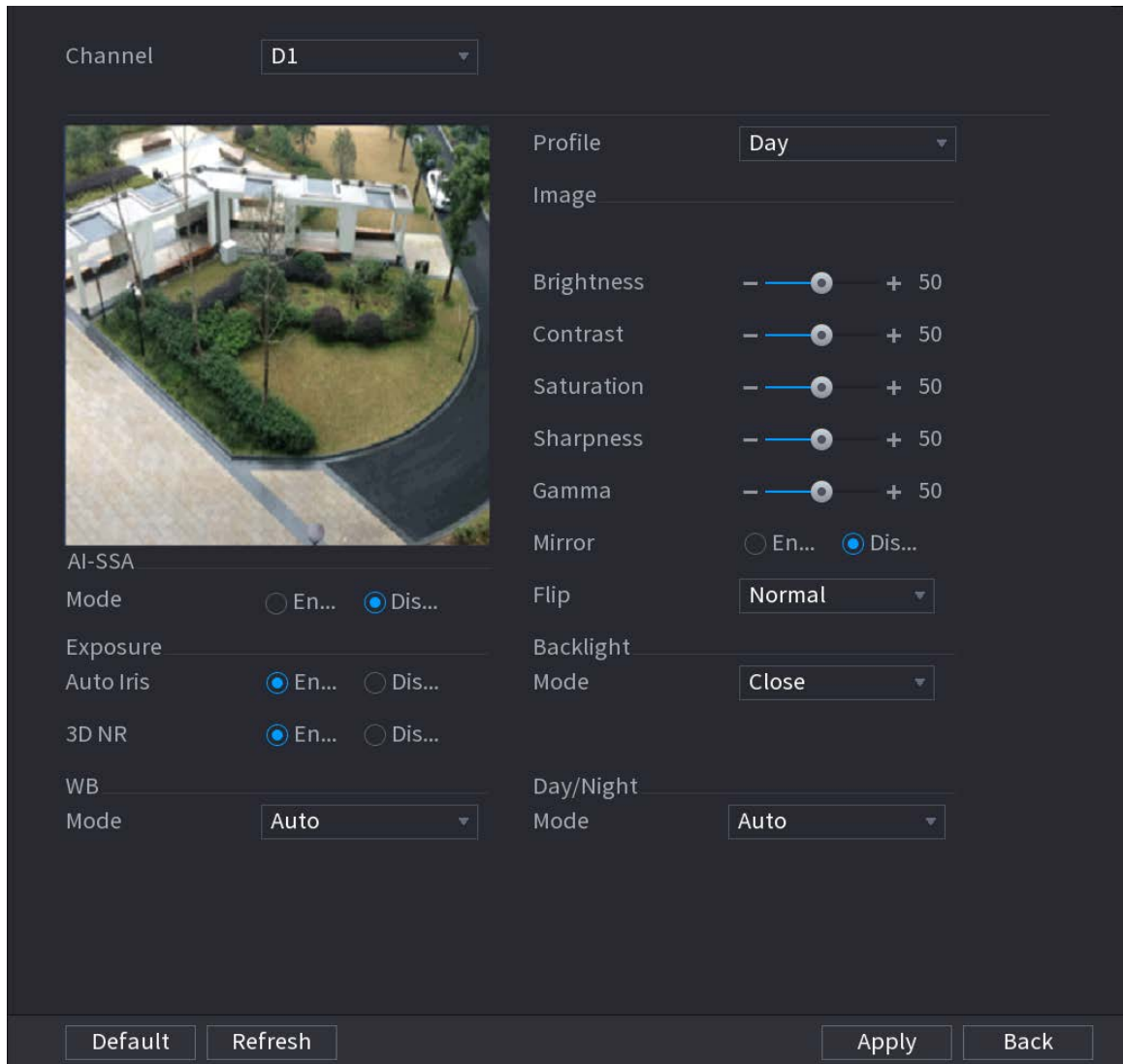



Step 2 Select a channel and then configure parameters.





The parameters might vary depending on the camera model.

Table 5-16 Image parameters

Parameter	Description
Profile	There are three configuration files. The system has configured the corresponding parameters for each file. You can select according to your actual situation.
Brightness	Adjust the image brightness. The bigger the value is, the brighter the image will become.
Contrast	Adjust the image contrast. The bigger the value is, the more obvious the contrast between the light area and dark area will become.
Saturation	Adjust the color shades. The bigger the value, the lighter the color will become.
Sharpness	Adjust the sharpness of image edge. The bigger the value is, the more obvious the image edge is.

Parameter	Description	
Gamma	Adjust image brightness and enhance the image dynamic display range. The bigger the value is, the brighter the video is.	
Mirror	Switch the left and right sides of the video image. It is disabled by default.  This function is available on select models.	
Flip	Set video display direction. It includes normal, 180°, 90°, and 270°.	
AI SSA	After you enable AI SSA (AI Scene Self-adaptation), the camera can detect environmental conditions, such as rain, fog, backlight, low light and flicker, to adjust the parameters of the image to suit the conditions, ensuring that clear images are always produced.  When AI SSA is enabled, some image parameters such as exposure and backlight mode will become unavailable.	
Exposure	Auto Iris	<ul style="list-style-type: none"> • This function is available when the camera is equipped with the auto iris lens. • After you enable auto iris function, the iris can automatically zoom in and zoom out according to the brightness of the environment and the image brightness changes accordingly. • If you disable the auto iris function, the iris is at the biggest value. The iris does not automatically zoom in or zoom out according to the brightness of the environment.
	3D NR	This function specially applies to the image whose frame rate is configured as 2 at least. It reduces the noise by using the information between two frames. The bigger the value is, the better the effect.

Parameter	Description
Backlight Mode	<p>You can set camera backlight mode.</p> <ul style="list-style-type: none"> ● SSA: In the backlight environment, the system can automatically adjust image brightness to clearly display the object. ● BLC: <ul style="list-style-type: none"> ◇ Default: The device performs automatic exposures according to the environment situation to make the darkest area of the video clear. ◇ Customize: After you select the specified zone, the system can expose the specific zone so that the zone can reach the proper brightness. ● WDR: In backlight environment, the system lowers the high bright section and enhances the brightness of the low bright section, so that you can view these two sections clearly at the same time. ● HLC: In the backlight environment, the system lowers the brightness of the brightest section, reduces the area of the halo and lowers the brightness of the whole video. ● Close: Disable the BLC function.
WB Mode	<p>You can set camera white balance mode. The system adjusts the overall image hue to make the image color display precisely as it is.</p>  <p>Different cameras support different white balance modes, such as auto, manual, natural light, and outdoor.</p>
Day/Night Mode	<p>Configure the color and black & white mode of the image. This parameter is not affected by the configuration files.</p> <ul style="list-style-type: none"> ● Color: The camera outputs color image only. ● Auto: The camera outputs color images or black and white images according to ambient brightness ● B/W: The camera outputs black and white image only. ● Sensor: Use this mode when there is peripheral IR light connected.  <p>The Sensor mode is available on select non-IR models.</p>

Step 3 Click **Apply**.

5.7.5 Configuring Overlay Settings

You can set parameters for overlay and private masking.

5.7.5.1 Overlay

Background Information

You can add the information of time and channel in the live view interface.

Procedure

Step 1 Select **Main Menu > CAMERA > Overlay > Overlay.**

Step 2 Select a channel and then configure parameters.

Table 5-17 Video overlay parameters

Parameter	Description
Time Title	Display the time tile on the video image in live view and playback. 1. Select Time Title . 2. Drag the time title to a desired place. 3. Click Apply .
Channel Title	Display the channel tile on the video image in live view and playback. 1. Select Channel Title and then edit the channel title. 2. Drag the channel title to a desired place. 3. Click Apply .
Custom Title	You can customize title to be overlaid on the video image. Click Setting to set the information such as font size, title content and text alignment, and then click OK .
Default	Restore the overlay settings to default configuration.
Copy to	Copy the overlay settings to other channels.

Step 3 Click **Apply**.

5.7.5.2 Privacy Masking

You can mask certain areas of the video image for privacy protection.

Procedure

Step 1 Select **Main Menu > CAMERA > Overlay > Privacy Masking.**

Figure 5-59 Privacy masking

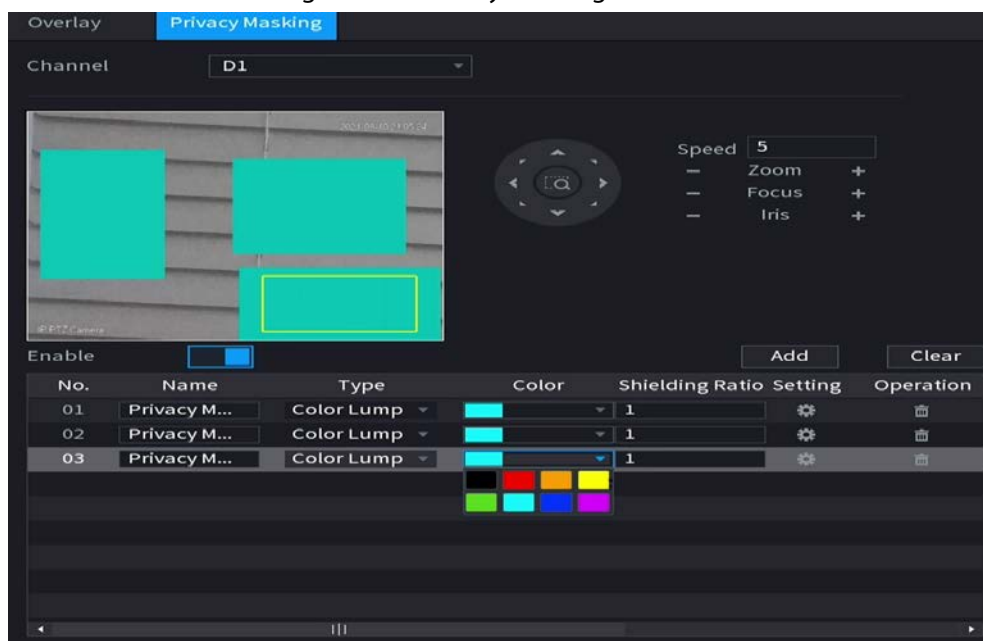

- Step 2 Select a channel.
- Step 3 Click  to enable privacy masking.
- Step 4 Click **Add**, select the masking type and color, and then draw mosaic or color blocks in the image as needed.
A masking block appears on the video image.



- The number of masking blocks that you can add might differ depending on the camera. You can add up to 24 masking blocks.
- Click **Clear** to delete all masking areas. Click  to delete a masking area.

- Step 5 Drag the masking block to a desired position and then configure the type, color and other parameters.
- Step 6 Click **Apply**.

5.7.6 Configuring Encoding Settings

You can set video bit stream and image parameters.

5.7.6.1 Configuring Audio and Video Encoding Settings

Background Information

You can set audio and video encoding parameters such as bit stream type, compression, and resolution.

Procedure

- Step 1 Select **Main Menu > CAMERA > Encode > Audio/Video**.

Figure 5-60 Audio/video



Step 2 Select a channel and then configure parameters.



The parameters for main stream and sub stream are different. Some models support three streams: main stream, sub stream 1, sub stream 2.

Table 5-18 Audio/video parameters

Parameter	Description
Coding Strategy	<ul style="list-style-type: none"> ● General: Use general coding strategy. ● Smart Codec: Enable the smart codec function. This function can reduce the video bit stream for non-important recorded video to maximize the storage space. ● AI Codec: Enable the AI codec function. This function can reduce the camera code stream, network transmission pressure, and hard drive storage space without affecting the image quality.
Type	Select the recording type for main stream from General , Motion (motion detection), or Alarm .
Compression	Select the encoding mode. <ul style="list-style-type: none"> ● H.265: Main profile encoding. This setting is recommended. ● H.264H: High profile encoding. Low bit stream with high definition. ● H.264: Main profile encoding. ● H.264B: Baseline profile encoding. This mode requires higher bit stream compared with other modes for the same definition.

Parameter	Description
Resolution	Select resolution for the video.  The maximum video resolution might be different depending on your device model.
Frame Rate (FPS)	Configure the frames per second for the video. The higher the value is, the clearer and smoother the image will become. Frame rate changes along with the resolution. Generally, in PAL format, you can select the value from 1 through 25; in NTSC format, you can select the value from 1 through 30. However, the actual range of frame rate that you can select depends on the capability of the Device.
Bit Rate Type	<ul style="list-style-type: none"> • CBR (constant bit rate): The bit rate changes slightly around the defined value. We recommended selecting CBR when there might be only small changes in the monitoring environment. • VBR (variable bit rate): The bit rate changes with monitoring scenes. Select variable stream when there might be big changes in the monitoring environment.
Quality	The bigger the value is, the better the image will become.  This parameter is available if you select VBR as Bit Rate Type .
I Frame Interval	The interval between two reference frames.
Bit Rate (Kb/S)	<ul style="list-style-type: none"> • Main stream: The higher the value, the better the image quality. • Sub stream: For constant stream, the bit rate changes near the defined value; for variable stream, the bit rate changes along with the image but the maximum value still stays near the defined value.

Step 3 Click **More**.

Figure 5-61 More settings

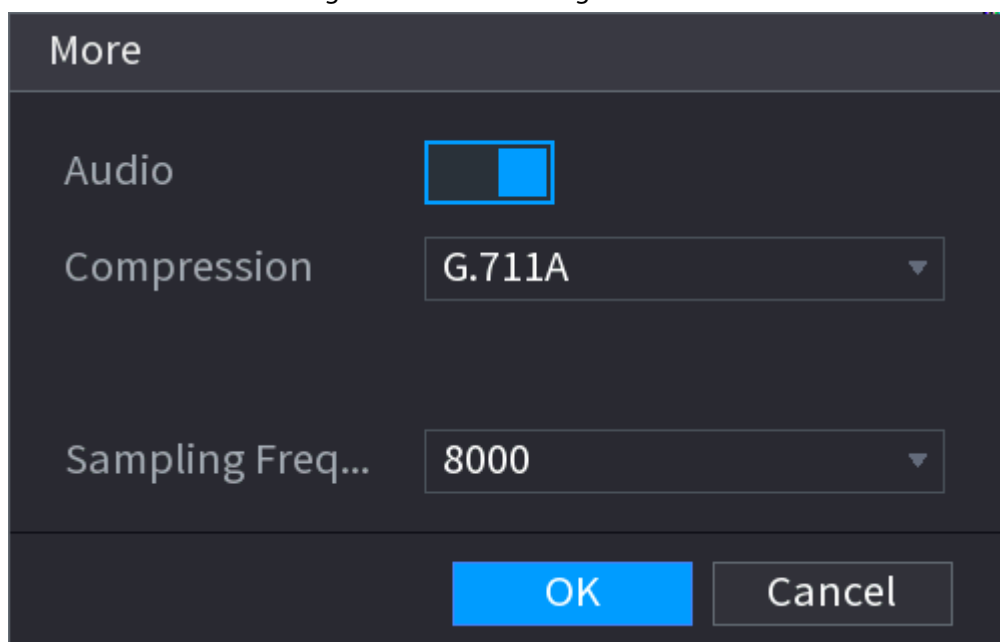

Step 4 Configure audio compression parameters.

Table 5-19 Audio compression parameters

Parameter	Description
Audio	This function is enabled by default for main stream. You need to manually enable it for sub stream. Once this function is enabled, the recorded video file is composite audio and video stream.
Compression	Select an audio compression format.
Sampling Frequency	Set how many times per second a sound is sampled. The bigger the value, the more natural the sound.

Step 5 Click **OK**.

Step 6 Click **Apply**.

5.7.6.2 Snapshot

Background Information

You can set snapshot mode, image size, quality and interval.

Procedure

Step 1 Select **Main Menu > CAMERA > Encode > Snapshot**.

Figure 5-62 Snapshot

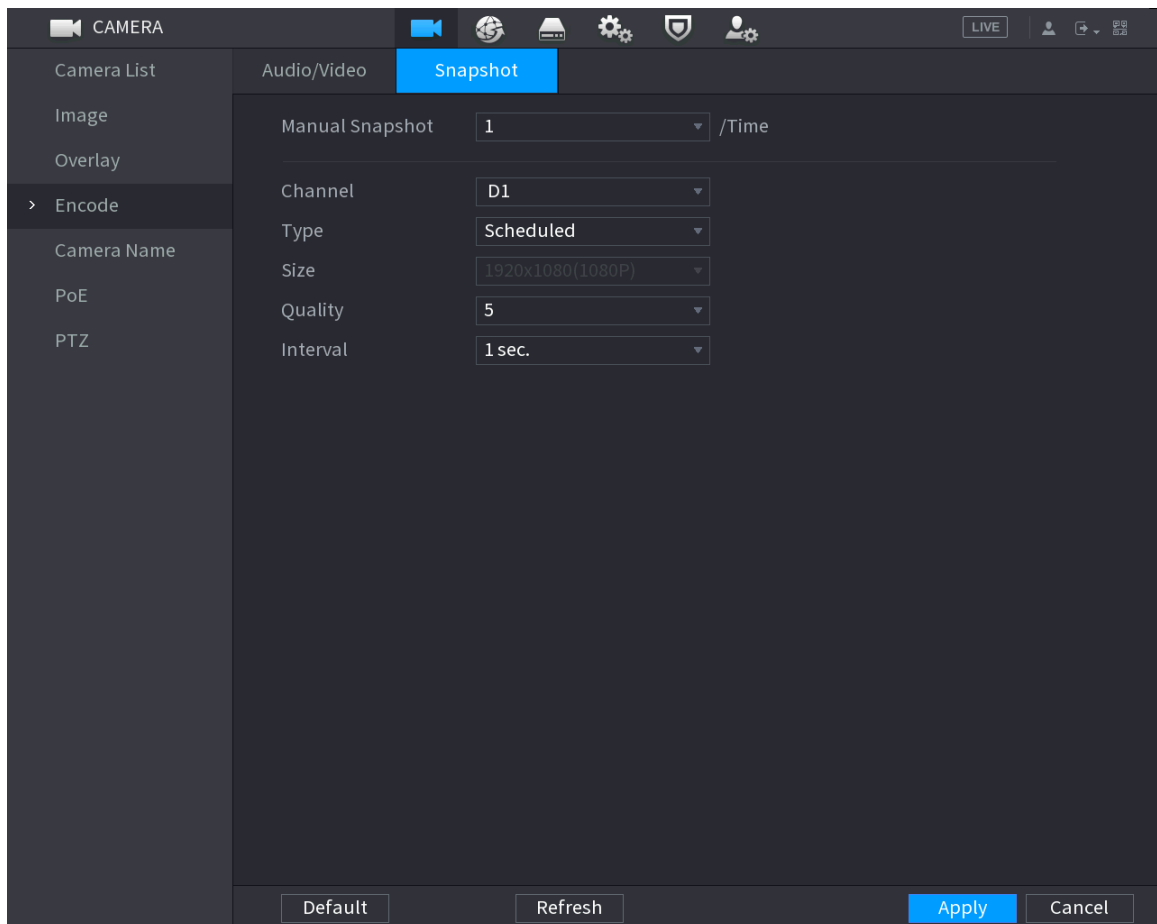

Step 2 Configure parameters.

Table 5-20 Snapshot parameters

Parameter	Description
Manual Snapshot	Select the number of snapshots that you want to take each time.
Channel	Select the channel that you want to configure the settings for.
Type	<ul style="list-style-type: none">• Scheduled: The snapshot is taken during the scheduled period.• Event: The snapshot is taken for motion detection, video loss, local alarms and other events.
Size	The size is determined by the resolution of the main stream or sub stream of the channel.
Quality	Configure the image quality. The higher the level is, the better the image will become. Level 6 represents the best quality.
Interval	Select or customize how frequently snapshots are to be taken.

Step 3 Click **Apply**.

5.7.7 Modifying Channel Name

Background Information

You can customize channel name.

Procedure

Step 1 Select **Main Menu > CAMERA > Camera Name**.

Figure 5-63 Camera name

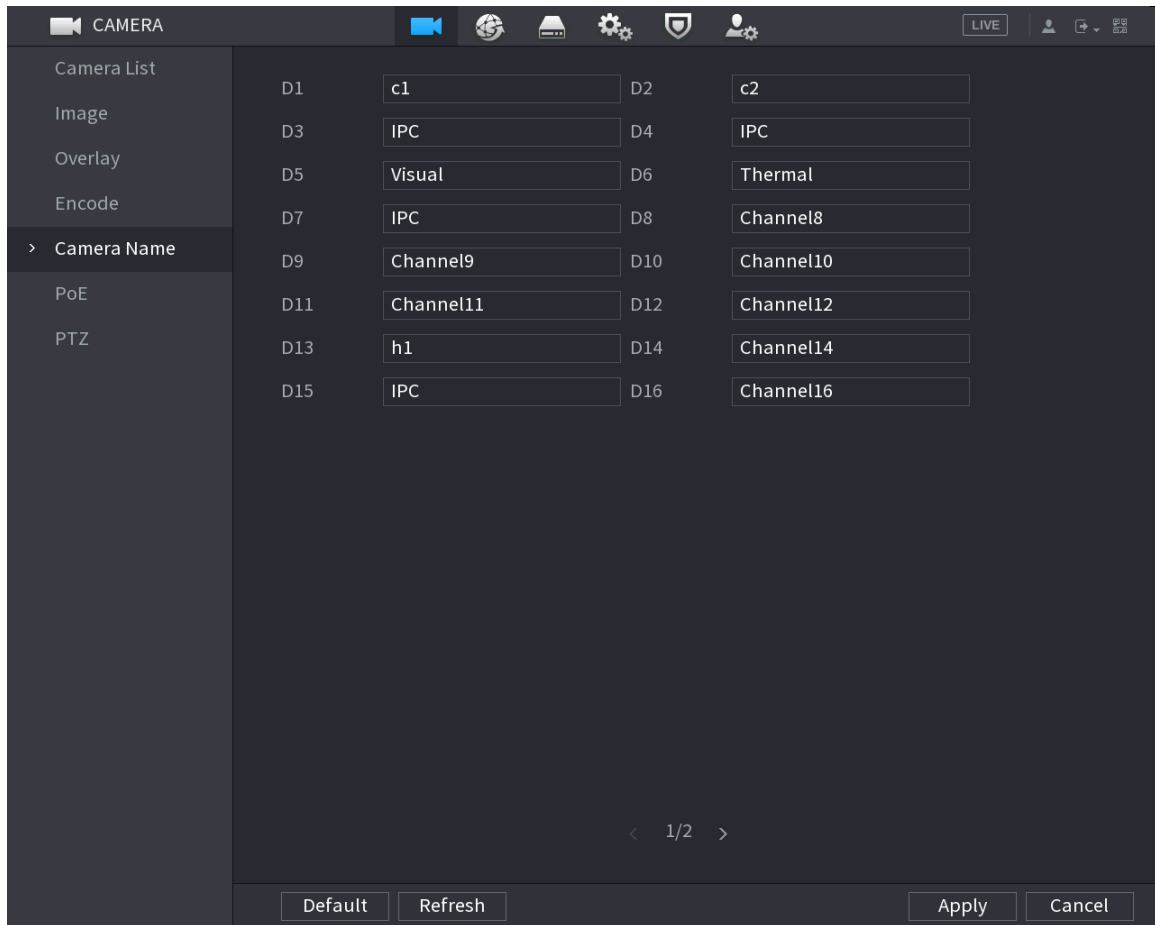

Step 2 Modify a channel name.



- You can only change the name of the camera connected via the private protocol.
- You can enter up to 63 English characters for a channel name.

Step 3 Click **Apply**.

5.7.8 Checking the PoE Status

You can check the status of PoE ports and set enhancement mode for each PoE port.

Procedure

Step 1 Select **Main Menu > CAMERA > PoE**.

Figure 5-64 PoE

Connected/Total		Actual/Total Power(W)			
0/16		0.0/150.0			
Status	Port	Link Quality	Enhancement Mode	Rate(Mbps)	Power(W)
	1	0	Off	-	-
	2	0	Off	-	-
	3	0	Off	-	-
	4	0	Off	-	-
	5	0	Off	-	-
	6	0	Off	-	-
	7	0	Off	-	-
	8	0	Off	-	-
	9	0	Off	-	-

Note:

- About icon : for PoE connection status, green circle means the device is connected and red circle means the device is disconnected ;
- Power protection function : Once the system detects the connected total power consumption exceeds the threshold, it begins to disconnect device one by one according to the port number (N-1). System stops disconnecting when the total power consumption is restored to rated power ;
- Link quality : It mainly contains three levels: poor, average and good. Try to enable signal enhancement mode when the link quality is poor.

Step 2 (Optional) Set **Enhancement Mode** to **On** or **Off**.



When enhancement mode is enabled, the transmission distance of the PoE port will be extended.

5.7.9 Updating Remote Devices

Background Information

You can update the firmware of the connected network camera through online update or file update.

Procedure

Step 1 Select **Main Menu > CAMERA > Camera List > Update**.

Figure 5-65 Update

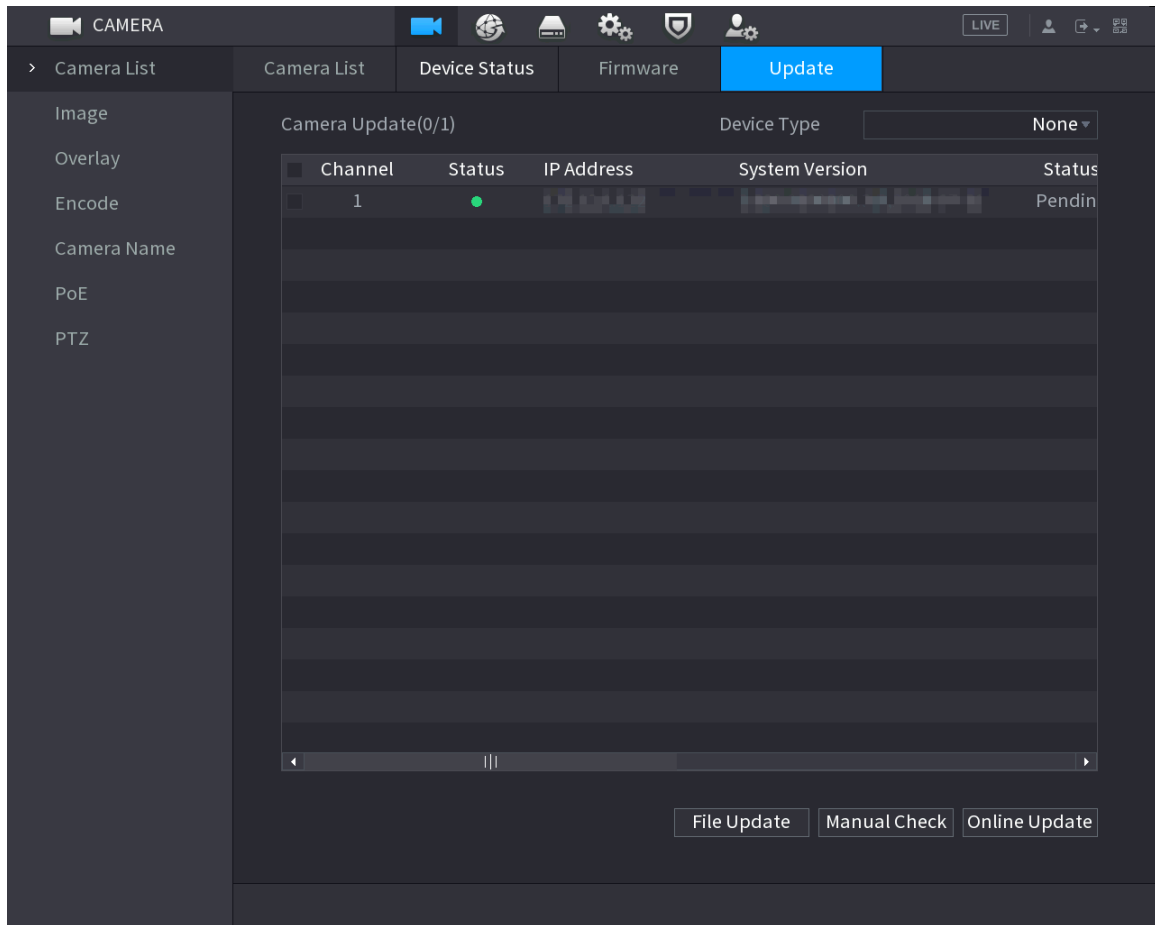

Step 2 Update the firmware of the connected remote device.

- Online update.
 1. Select a remote device and then click **Manual Check**

The system checks for available updates.

2. Select a remote device that has an update available for it, and then click **Online Update**.

- File update.
 1. Select a channel and then click **File Update**.
 2. Select an update file.
 3. Click **OK**.



If there are too many remote devices, you can filter them on the **Device Type** list.

5.7.10 Viewing Remote Device Information

5.7.10.1 Device Status

You can view the connection and alarm status of the corresponding channel.

Select **Main Menu > CAMERA > Camera List > Device Status**.

Figure 5-66 Device status

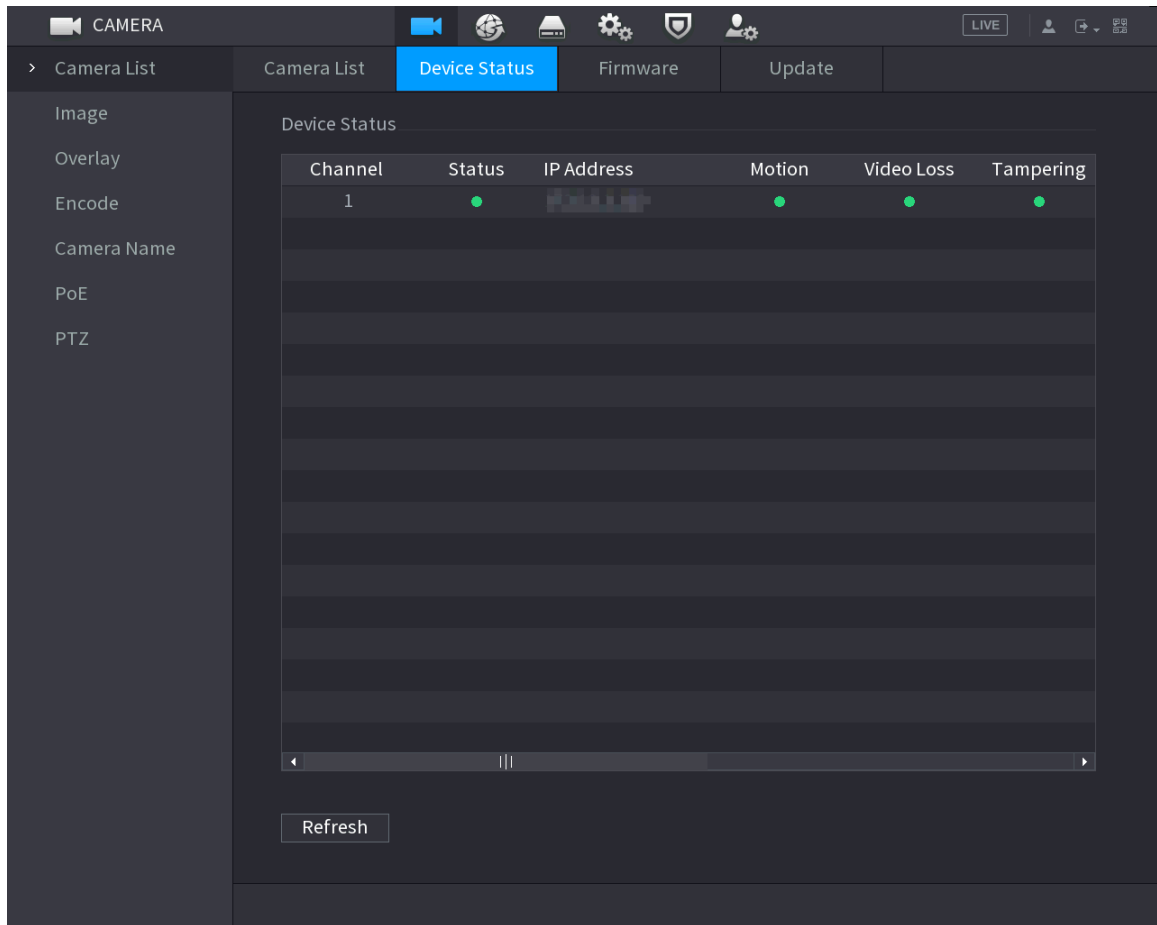

Table 5-21 Parameters of device status

Icon	Description	Icon	Description
	IPC works properly.		IPC is not supported.
	Alarm.		Video loss.

5.7.10.2 Firmware

You can view the IP address, manufacturer, type, and system version of the connected remote device.

Select **Main Menu > CAMERA > Camera List > Firmware**.

Figure 5-67 Firmware

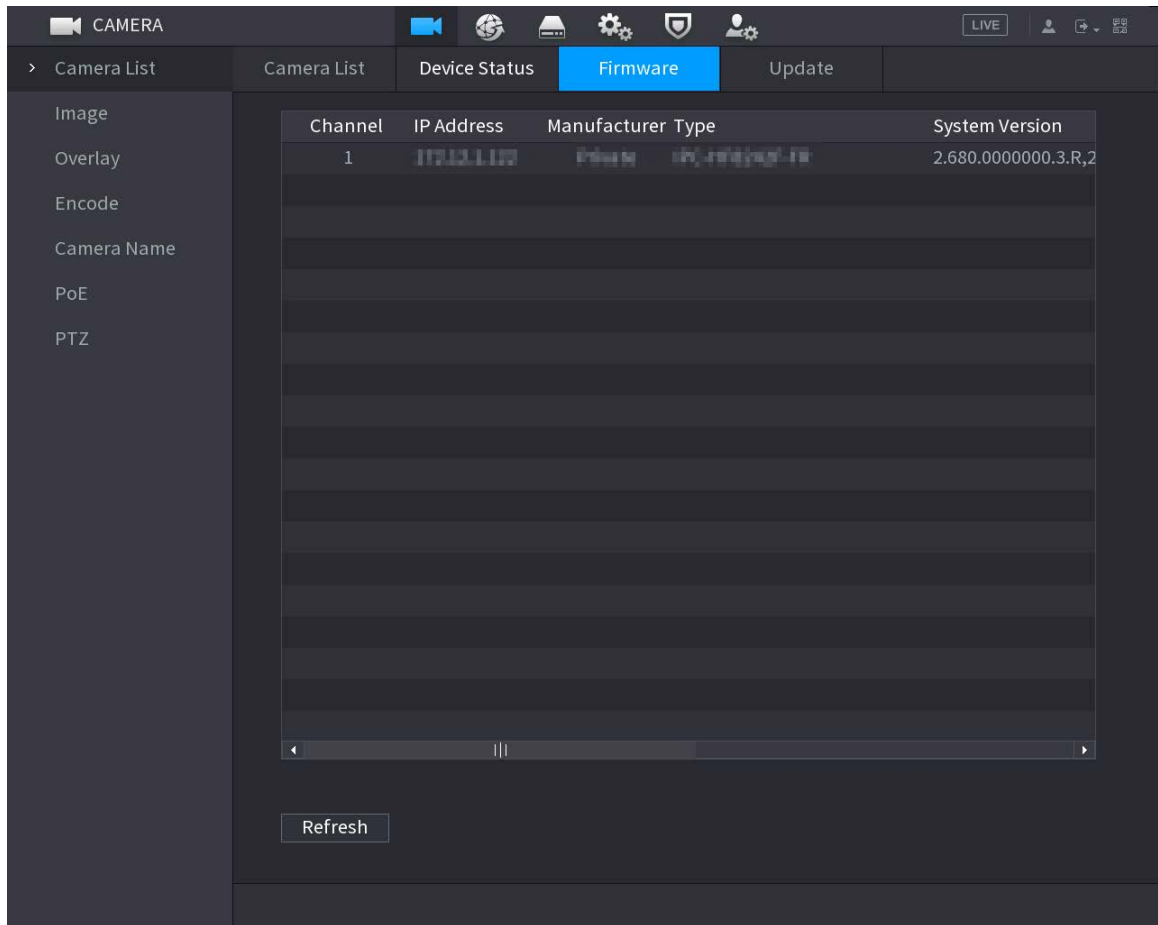

5.8 Recording Management

5.8.1 Recording Schedule

After you set the recording schedule for videos and snapshots, the Device can automatically record videos and snapshots at the scheduled time.

5.8.1.1 Configuring Video Recording Schedule

Background Information

After you set the schedule for videos, the Device will record videos according to the period you set. For example, if the alarm recording period is from 6:00–18:00 on Monday, the Device will make a recording on Mondays from 6:00-18:00.

Procedure

Step 1 Right-click the live page, and then select **Main Menu > STORAGE > Schedule > Record**.

Figure 5-68 Video schedule

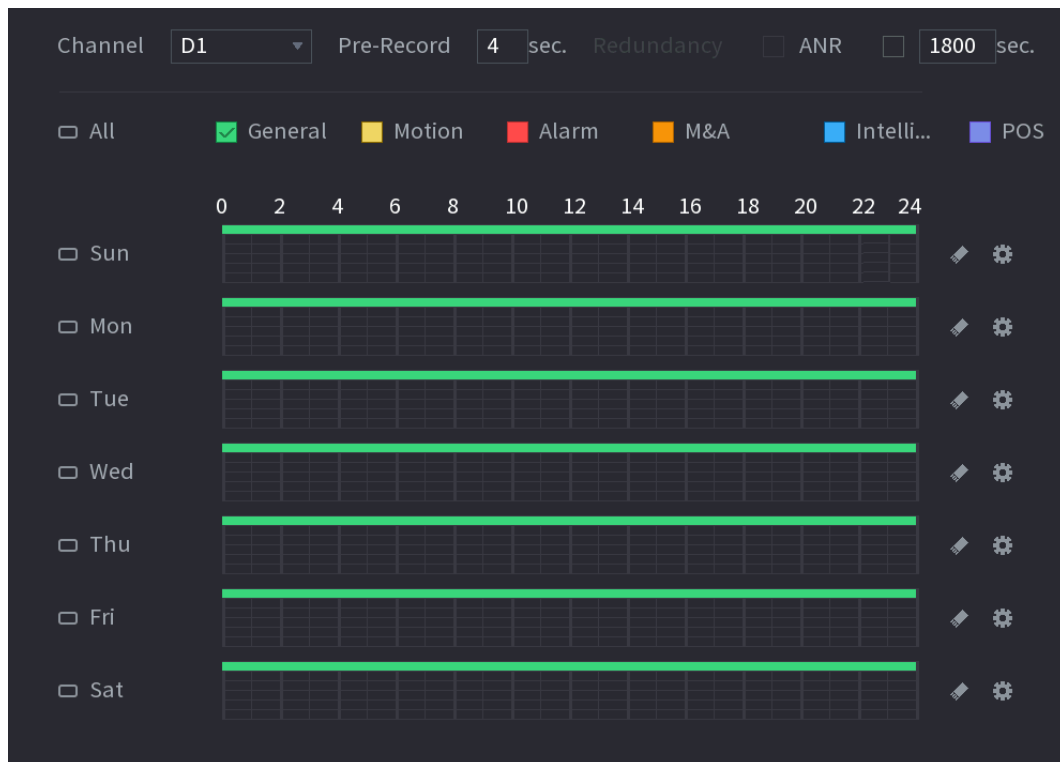

Step 2 Configure the parameters.

Table 5-22 Video schedule parameters

Parameter	Description
Channel	Select a channel to record a video.
Pre-record	Enter the amount of time that you want the pre-recording to last. A recording will be made prior to the event.
Redundancy	<p>If there are several HDDs installed to the Device, you can set one of the HDDs as the redundant HDD to save the recorded files into different HDDs. If one of the HDDs becomes damaged, you can find the backup on the other HDD.</p> <ul style="list-style-type: none"> ● Select Main Menu > STORAGE > Disk Manager, and then set a HDD as redundant HDD. ● Select Main Menu > STORAGE > Schedule > Record, and then select the Redundancy checkbox. <ul style="list-style-type: none"> ◇ If the selected channel is not recording, the redundancy function will take effect the next time that you record, whether or not you select the checkbox. ◇ If the selected channel is recording, the current recorded files will be packed, and then start recording according to the new schedule. <p> This function is for some models only.</p> <ul style="list-style-type: none"> ● The redundant HDD only backs up the recorded videos but not snapshots.

Parameter	Description
ANR	<p>You can set the ANR (auto network resume) function.</p> <ul style="list-style-type: none"> The IPC continues recording once the NVR and IPC connection fails. After the network becomes normal, the NVR can download recording files while it is disconnected from the IPC. This is to help protect against data loss from the current IPD channel that is connected. Set the maximum recording upload period. If the offline period is longer than the period you set, IPC will only upload the recording file during the specified period. <p> Make sure that SD card is installed and the recording function is enabled on the IPC.</p>
Period	<p>Set a period during which the configured recording setting is active.</p> <p> The system only activates the alarm in the defined period.</p>
Copy to	Click Copy to to copy the settings to other channels.

Figure 5-69 Period

Step 3 Set one or more recording types from **General**, **Motion** (motion detection), **Alarm**, **M&A** (motion detection and alarm), **Intelligent** and **Alarm**.

Figure 5-70 Recording type

Step 4 Set recording period.



If you have added a holiday, you can set the recording period for the holiday.

Figure 5-71 Set record period

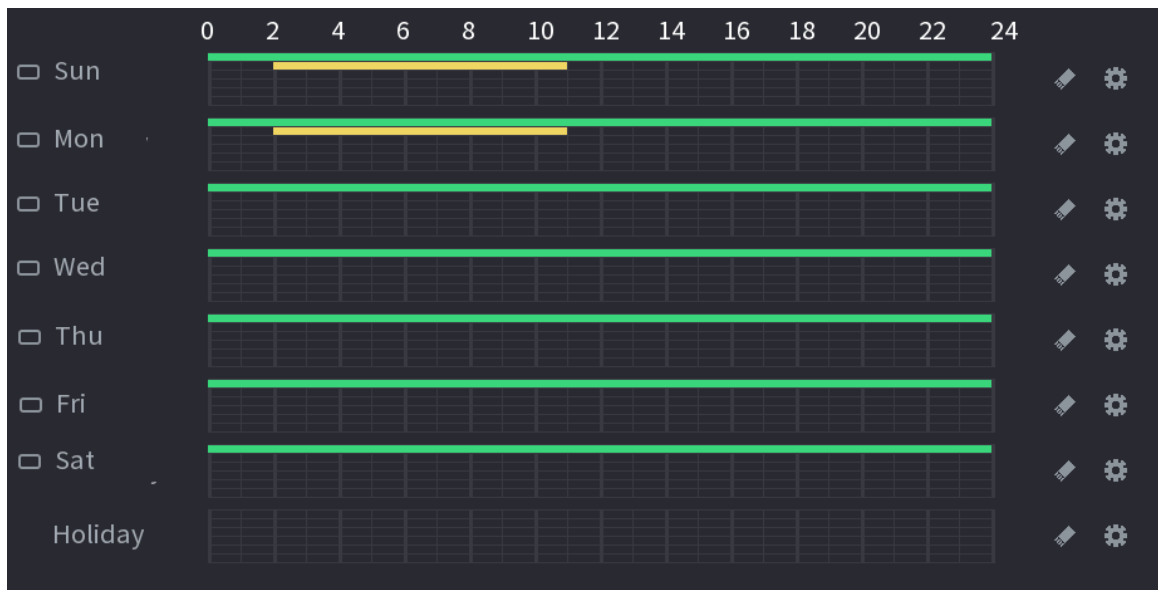

- Define the period by drawing.
 1. Select a corresponding date to set.
 - ◇ Define for the whole week: Click next to **All**. All the icon switch to . You can define the period for all the days simultaneously.
 - ◇ Define for several days of a week: Click before each day one by one. The icon switches to . You can define the period for the selected days simultaneously.
 2. On the timeline, drag to define a period.
 - ◇ Once the time period overlaps, the recording priority is: **M&A > Alarm > POS > Intelligent > Motion > General**.
 - ◇ Select a recording type and then click the of the corresponding date to clear the corresponding period.

Figure 5-72 Set period by drawing



The MD record and alarm record function are both null if you enabled MD&Alarm function.

- Define the period by editing.
 1. Select a date and then click .

Figure 5-73 Set period by editing

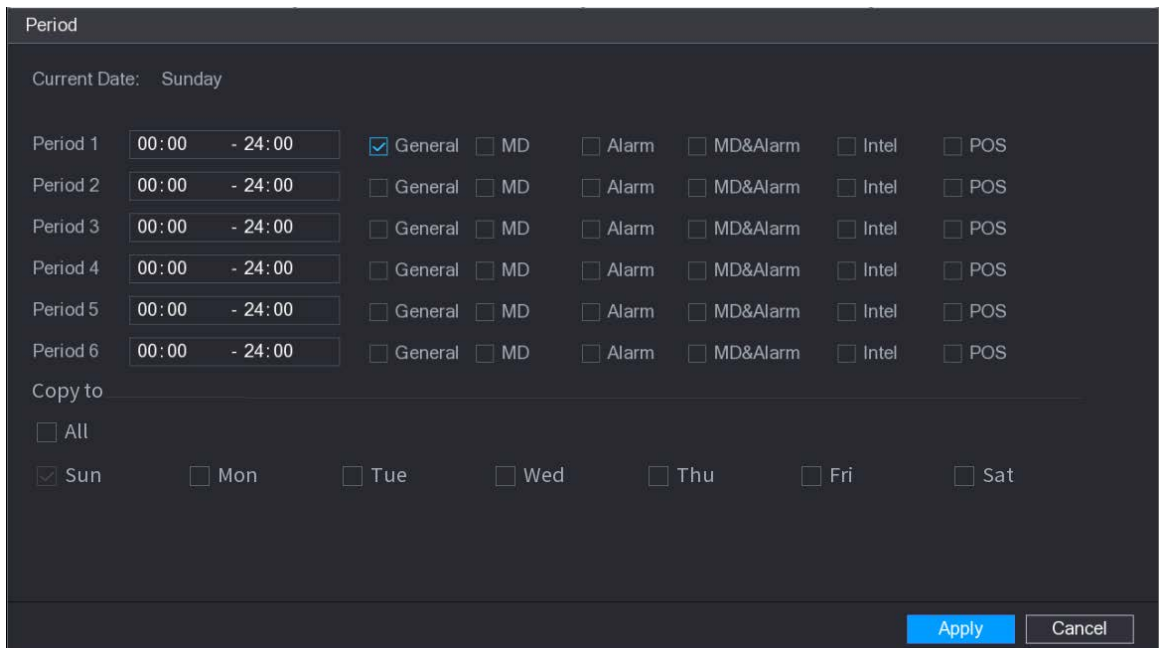

2. Set the recording type for each period.
 - ◇ There are six periods for you to set for each day.
 - ◇ Under **Copy to**, select **All** to apply the settings to all the days of the week, or

select specific days that you want to apply the settings to.

3. Click **Apply**.

Step 5 Click **Apply** to complete the settings.

5.8.1.2 Configuring Snapshot Schedule

Background Information

Configure recording schedule for snapshots.

Procedure

Step 1 Right-click the live page, and then select **Main Menu > STORAGE > Schedule > Snapshot**.

Figure 5-74 Snapshot

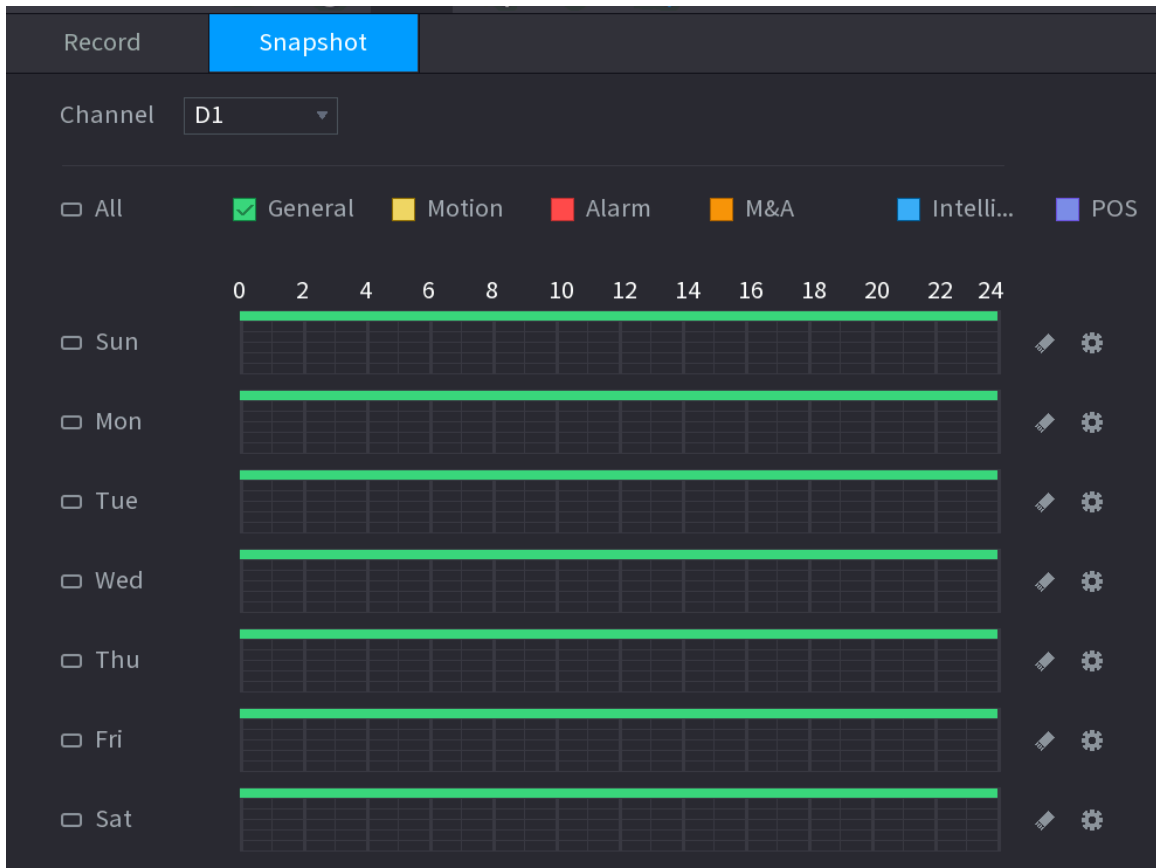

Step 2 Select a channel to set schedule snapshot.

Step 3 Set a recording type.

Figure 5-75 Recording type



Step 4 Set snapshot period. For details, see Step 4 in "5.8.1.1 Configuring Video Recording Schedule".

Step 5 Click **Apply**.

5.8.1.3 Configuring Recording Mode

Background Information

After you set schedule record or schedule snapshot, you need to enable the auto record and snapshot function so that the system can automatically record or take snapshot.

- Auto: The system automatically records the videos and snapshots according to the defined schedule.
- Manual: The system records general files for the entire day.



You need to have storage authorities to use the **Manual** recording mode.

Procedure

Step 1 Right-click the live page, and then select **Main Menu > STORAGE > Record**.

Figure 5-76 Recording mode

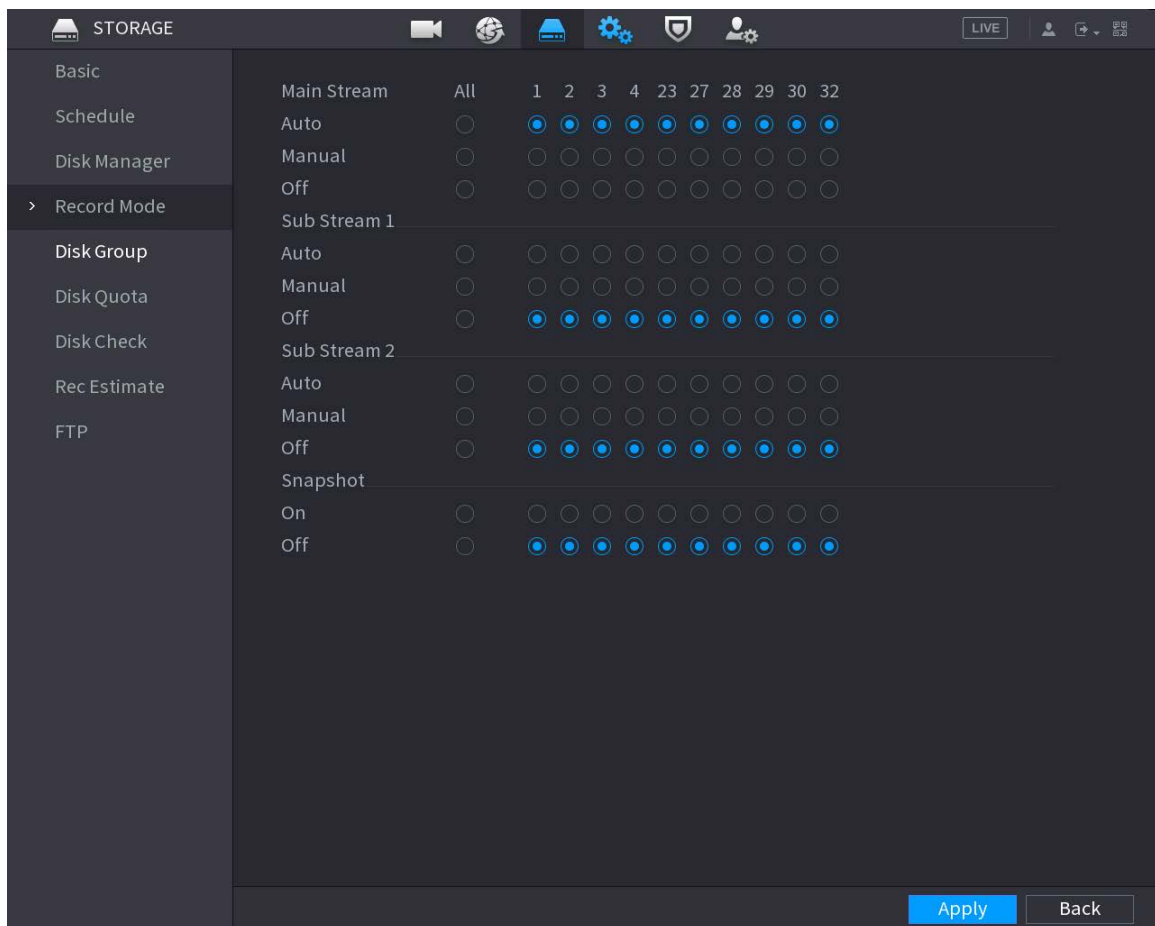

Step 2 Configure parameters.

Table 5-23 Recording mode parameters

Parameter	Description
Channel	Displays all the connected channels. You can select a single channel or select All .

Parameter	Description
Recording status	<ul style="list-style-type: none"> • Auto: Automatically make recordings according to the schedule. • Manual: Makes a general recording within 24 hours for the selected channel. • Off: Do not record.
Snapshot status	Enable or disable the scheduled snapshot for the corresponding channels.

Step 3 Click **Apply**.

5.8.2 Search and Playback

5.8.2.1 Search Page

You can search for and play back the recorded files on the NVR.

Select **Main Menu > SEARCH**, or right-click on the live view page and then select **Search**.













The following figure is for reference only.

Figure 5-77 Search



Table 5-24 Search page description

No.	Function	Description
1	Display window	<p>Display the searched recorded video or picture. The system supports playing in single-channel, 4-channel, 9-channel, and 16-channel simultaneously.</p>  <p>When playing back in the single-channel mode, hold down the left mouse button to select the area that you want to enlarge. The area is enlarged after the left mouse button is released. To exit the enlarged status, right-click the image.</p>
2	Playback controls bar	Playback control buttons.
	Clip	Click  to clip the recording file and then save the footage. See "5.8.2.4 Clipping Videos" for details.
	Backup	Click  to back up recordings.
3	Time bar	<p>Display the type and time period of the current recorded video.</p> <ul style="list-style-type: none"> In the 4-channel layout, 4 time bars are displayed. In other view layouts, only 1 time bar is displayed. Click the colored area to start playback from a certain time. When you are configuring the settings, rotate the wheel button on the time bar to zoom in from 0. When a playback is being played, rotate the wheel button on the time bar, the time bar will zoom into the time point where the playback is located. Time bar colors: Green for general type; red for external alarm; yellow for motion detection; blue for intelligent events; purple for POS events. Click and hold the time bar, and the mouse pointer changes to a hand icon, and then you can drag to view the playback of the target time. You can drag the vertical orange line on the time bar to rapidly view the playback in iframe format. When playing back a video in one channel mode, point to the time bar for 0.1 seconds, and then you can view 4 pictures before and after the selected time, and the thumbnail picture of the selected time. For some models, when you click the blank area in the time bar, the system automatically jumps to the next time point where there is a recorded video located.
4	Play status	Includes 2 playback status: Play and Stop .
	Record type	Select the checkbox to define the recording type to search for.

No.	Function	Description
5	Search type	Select the content to play back: Record , Picture , and Subperiod .
6	Calendar	Click the date that you want to search for.  The dates with recordings or snapshots have a small solid circle under the date.
7	View layout and channel selection	<ul style="list-style-type: none"> In the Camera Name list, select one or more channels that you want to play back. The window split is decided by how you select the channels. For example, if you select 1 channel, the playback is displayed in the single-channel view. If you select two to four channels, the playback is displayed in the four-channel view. The maximum is eight channels. Click  to switch the streams.  indicates main stream, and  indicates sub stream.
8	List display	This area includes Tag List and File List .  The icons displayed might vary with models. <ul style="list-style-type: none"> : Click Tag List to view the marked recorded video list. Double-click the file to start playing. : Click File List to view the files that were found. You can lock and unlock the files. See "5.8.2.6 File List" for detailed information. : fisheye dewarp. See "5.6.10.2 Fisheye De-warp During Playback" for detailed information.
9	Time bar unit	You can select 24 hr, 2 hr, 1 hr, or 30 min as the unit of time bar.



All the operations for playback might vary with hardware versions. Some functions are available on select models.

5.8.2.2 Playback

Background Information

You can search for and play back videos, images or video clips. The operations are similar. This section uses video playback as an example.

Procedure

Step 1 Select **Main Menu > Search**, or right-click the live page and then select **Search**.

Step 2 Select **From R/W Disk** or **From I/O Device**.

- From R/W Disk: Search for recorded files on the HDD of the Device.

Figure 5-78 Search from R/W disk

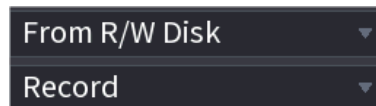

- From I/O Device: Search for recorded files from external storage device. Click **Browse**, select the storage path of the recorded video file that you want to play. Double-click the video file or click to start playing.

Figure 5-79 Search from I/O device

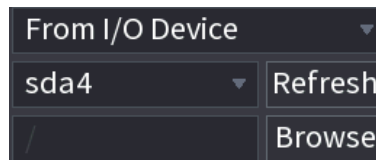

Step 3 Select **Record** as the search type.

Step 4 Select the date, and channel.

Step 5 Click or any position on the time bar.

The system starts playback. You can use the playback controls to control the playback process.

Figure 5-80 Playback control



Table 5-25 Playback control description

Icon	Function
	Play/Pause In slow play mode, click it to switch between play/pause.
	Stop When playing back, click to stop current playback process.
	Rewind In normal play mode, left-click the button, the file begins to rewind. Click it again to pause it. While it is rewinding, click or to restore normal play.
	Display previous frame/next frame. When you pause the normal playback file, click or to play back frame by frame. In frame by frame playback mode, click or to resume normal playback mode.
	Slow play In playback mode, click it to use various slow play modes such as slow play 1, slow play 2, and more.
	Fast forward In playback mode, click to realize various fast play modes such as fast play 1, fast play 2 and more.

Icon	Function
	Adjust the volume of the playback.
	Smart search. See "5.8.2.3 Smart Search Playback" for detailed information.
	Smart motion detection. You can click the icon to select a human or motor vehicle, and the system plays detected videos of the person or motor vehicle. Human and motor vehicle can be selected at the same time.
	Click the snapshot button in the full-screen mode to take one snapshot. System supports custom snap picture saved path. Connect the peripheral device first, click snap button on the full-screen mode, you can select or create a path. Click Start button, the snapshot picture can be saved to the specified path.
	Mark button. This function is available on select models. Make sure there is a mark button in the playback control pane. See "5.8.2.7 Tag Playback" for detailed information.
	Display and hide POS information. In 1-channel playback mode, you can click it to display/hide POS information on the video.
	In 1-channel playback mode, click it to enable or disable display IVS rule information on the video. This function is for some series only.
	Picture search. For details, see "5.6.3.7 Picture Search".
	Quick pick. For details, see "5.6.3.8 Quick Pick".

5.8.2.3 Smart Search Playback

Background Information



This function is for some models only.

During the playback process, the system can analyze the motion detection zone in the scene and give the analysis result.



Make sure that motion detection has been enabled in **Main Menu > ALARM > Video Detection > Motion Detection.**

Procedure

Step 1 Select a channel to playback video and then click . You can view the grids on the playback video.



- This function is for one-channel playback mode.
- In multiple-channel playback mode, double-click a channel to switch to one-channel playback mode.

Step 2 Select smart search zones (22*18(PAL), 22*15(NTSC)).

Step 3 Click  to go to smart search and playback. The system is going to play back all motion detection record footage.

Step 4 Click  again to stop smart search.



- The motion detection region cannot be the full screen zone.
- The motion detection region adopts the current whole play pane by default.
- The time bar unit switch, rewinding, frame by frame are not available when the system is playing a motion detection file.

5.8.2.4 Clipping Videos

Background Information

You can clip some footage from recorded videos to a new file and then save to the USB device.

Procedure

Step 1 Select a record first and then click  to play back.

Step 2 Select a time on the time bar and then click  to start clip.

Step 3 Select a time on the time bar and then click  to stop clip.

Step 4 Click , the system pops up dialogue box to save the clip file.

Figure 5-81 Clip



5.8.2.5 Backing Up

Background Information

You can back up recorded videos, images, or video clips to a USB storage device.

Procedure

Step 1 Select the files that you want to back up.

- Videos or images. Click  at the lower-right corner of the search page, and then on

the file list, select the files for backup.

- Video clips. See "5.8.2.4 Clipping Videos".

Step 2 Click .

Figure 5-82 Backup

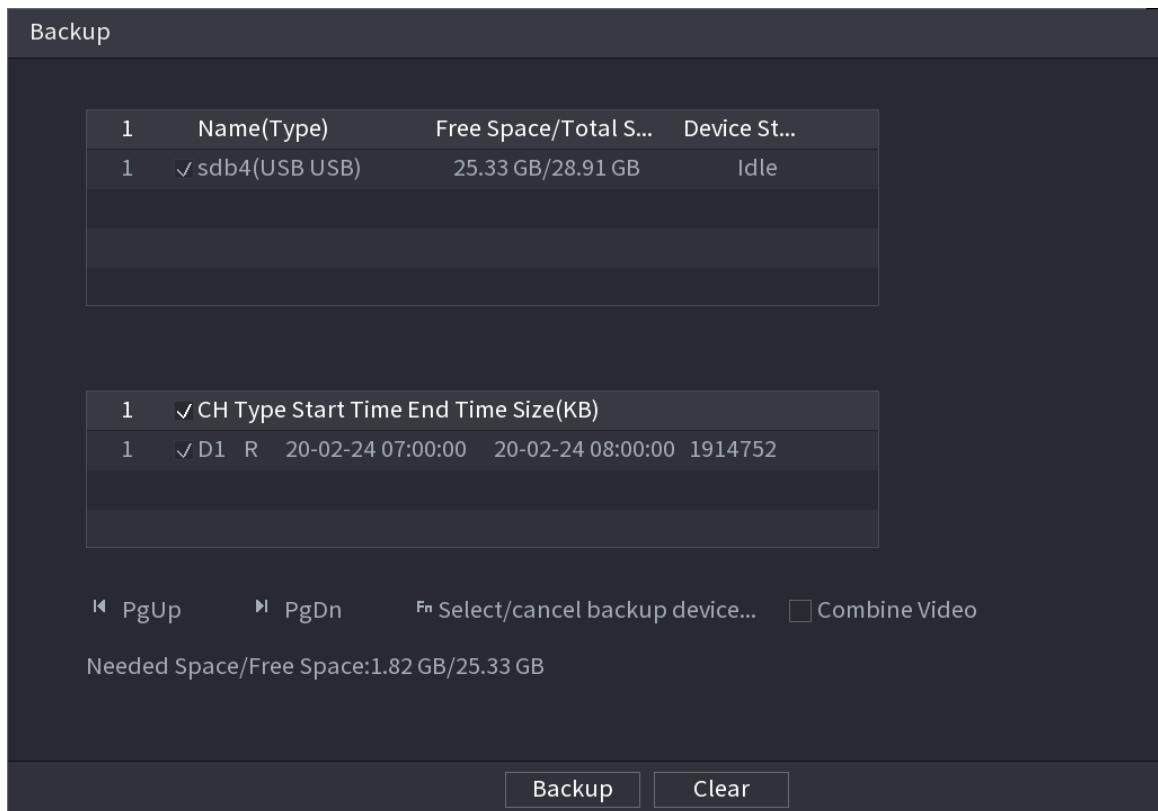





Step 3 Select the storage device, and then click **Backup**.



- You can cancel the selection of the files that you do not want to back up.
- Select **Combine Video** to merge several videos into one.

5.8.2.6 File List

On the search page, select a channel, and then click  to view the file list. On the file list, you can manage the files of the selected channel.

- Play.
Double-click a file to play.
- Search.
Select a specific time and then click .
- Lock or unlock files.
 - ◇ To lock files, on the file list, select one or more files, and then click . The locked files will not be overwritten.
 - ◇ To unlock files, click , and then select one or more files and then click **Unlock**.
- Go back to the previous page.
Click  to return to the page with calendar.

5.8.2.7 Tag Playback

When you are playing back a video, you can add a tag to mark an important point in time on the video. After playback, you can use time or the tag keywords to search for the corresponding video and then play.

Adding Tag

When the system is playing back, click , and then configure the tag name.

Playing back Tag

During single-channel playback, click , and then on the tag list, double-click a file to play back.



To search for tagged videos by time, select the tag time and then click .

Playing before Tagged Time

You can choose to play back from the previous N seconds of the tag time.



The system can play back previous N seconds before the tagged time if there is a video at that point. Otherwise, the system plays back as much as there is.

Managing Tags

On the tag list, click .

Figure 5-83 Tag management

The screenshot shows a 'Manager' window with the following fields and table:

- Channel: 5
- Start Time: 2017 - 11 - 08 00 : 00 : 00
- End Time: 2017 - 11 - 09 00 : 00 : 00
- Search button

2	CH	Mark Time	Name
1	5	2017-11-08 03:19:30	123
2	5	2017-11-08 10:30:34	456

Buttons: Delete, Cancel

- To search for the tagged video, select channel number, start time and end time, and then click

Search.

- To change the tag name, double-click a tagged video, and then enter the new name.
- To delete tags, select one or more tagged videos, and then click **Delete**.

5.8.3 Recording Information

Select **Main Menu > MAINTAIN > System Info** to view the recording information.

Figure 5-84 Recording information

Version	Disk	Record	BPS	Legal Info
Device Name	Start Time	End Time		

5.9 AI

AI detection is to process and analyze the image and extract the key information, and then compare the key information with the preset detection rule. An alarm is triggered when the detected behavior matches the detection rule.



The following figures are for reference only and might differ from the actual situation.

5.9.1 Overview

AI detection falls into AI by camera and AI by recorder.

- AI by camera: Some cameras themselves support AI detection. The cameras perform AI detection and send the detection results to the NVR for display. When using AI by camera, make sure to connect the Device to the cameras that support the corresponding AI detection functions.
- AI by recorder: The cameras send videos to NVR for detection, analysis and result display.



- Some models support AI by camera only.
- The AI functions might vary with models.
- Different AI functions might conflict with each other. You cannot enable two conflicting AI functions for the same channel.

5.9.2 Smart Plan

Background Information

To use AI by camera for face detection, face recognition and other detection functions, you need to enable the corresponding smart plan first.

Procedure

Step 1 Select **Main Menu > AI > Parameters > Smart Plan**.

Step 2 Select a channel.



The page might differ depending on which smart plans that the remote device supports.

Figure 5-85 Smart plan

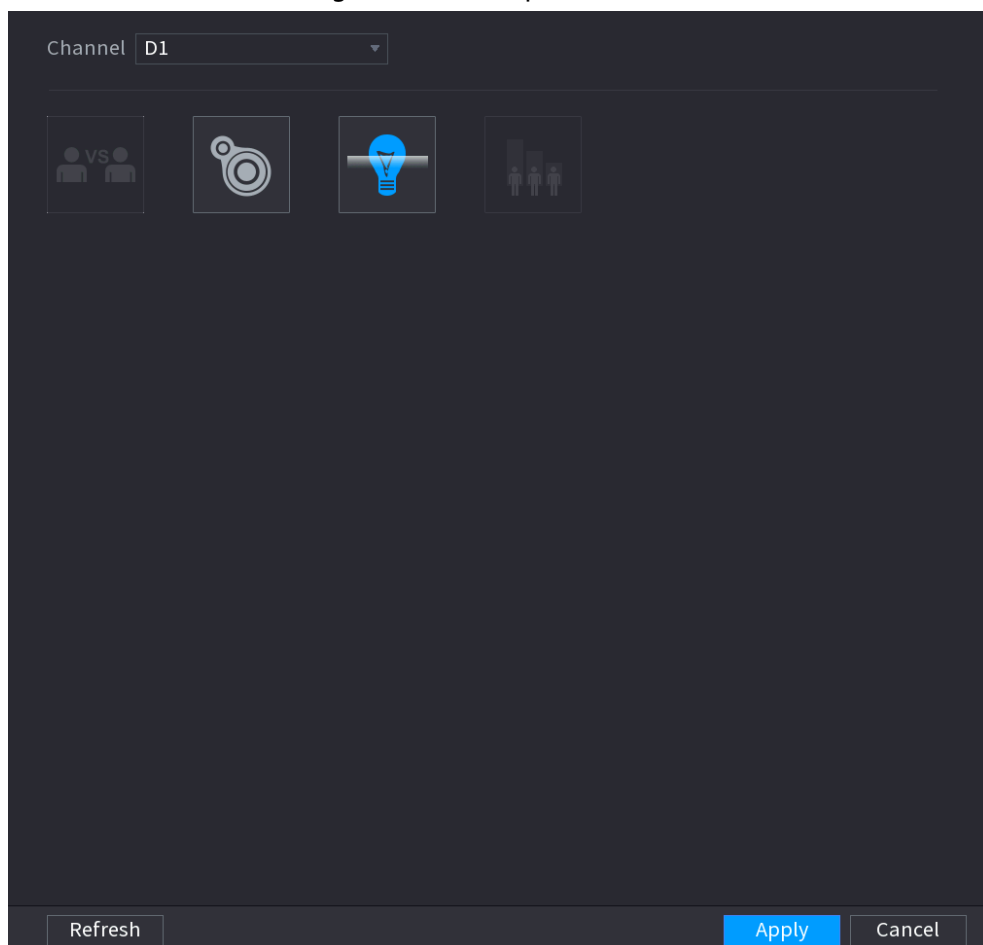

Step 3 Click the icon that represents the smart plan to enable it. The icon becomes highlighted.



If the channel is connected to a PTZ camera, you can set smart plans separately for each preset point.

Figure 5-86 Smart plan (PTZ)

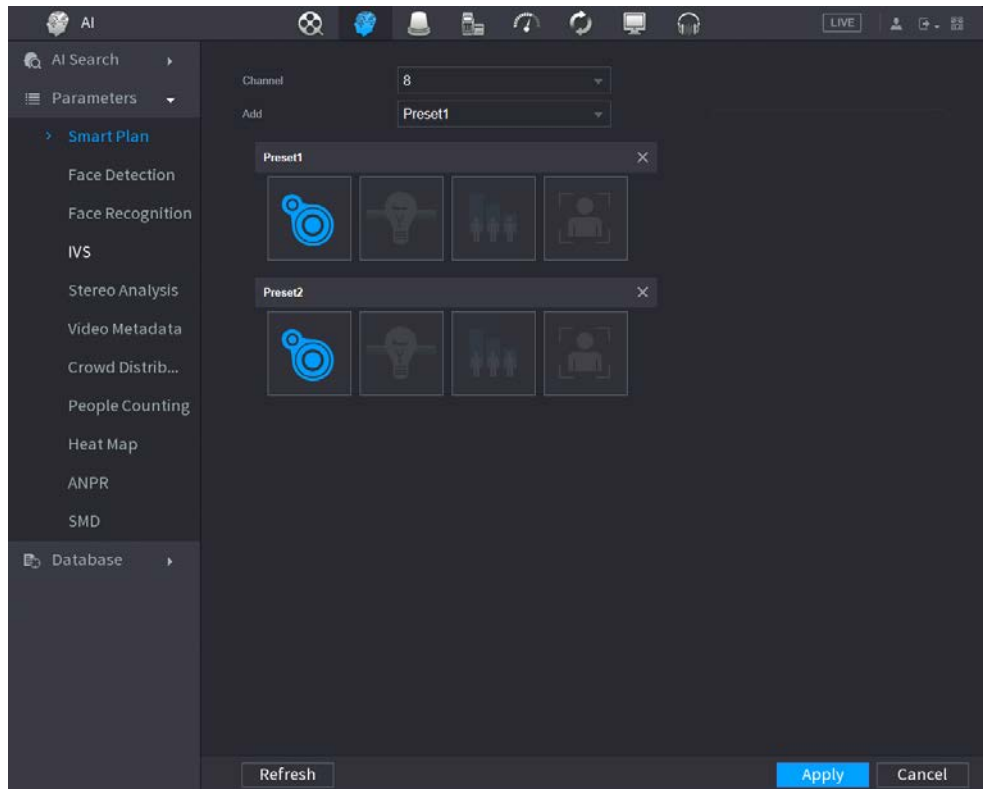

Step 4 Click **Apply**.

5.9.3 Face Detection

The Device can detect faces on the video image.

5.9.3.1 Enabling Smart Plan

To use AI by camera, you need to enable the smart plan first. For details, see "5.9.2 Smart Plan".

5.9.3.2 Configuring Face Detection

Background Information

Configure alarm rules for face detection.

Procedure

Step 1 Select **Main Menu > AI > Parameters > Face Detection**.

Figure 5-87 Face detection

Step 2 Select a channel, and then select **AI by Reorder** or **AI by Camera** as **Type**.



When **AI by Camera** is selected, you can enable **Face Enhancement** to improve face detection efficiency.

Step 3 Click  to enable face detection.

Step 4 Click **Setting** next to **Rule** to draw areas to filter the target.

You can configure two target filters (maximum size and minimum size). The system triggers an alarm when the size of detected target is between the maximum size and the minimum size.

Step 5 Click **Setting** next to **Schedule** to configure the arming period.

The system triggers corresponding alarm actions only during the arming period.

- On the time line, drag to set the period.
- You can also click  to set the period.

Step 6 Configure alarm linkage actions. For details, see [Step 7](#).

Step 7 Click **Apply**.

5.9.3.3 AI Search (Face Detection)

Background Information

You can search for the detected faces and play back related recordings.

Procedure

Step 1 Select **Main Menu > AI > AI Search > Face Detection**.

Figure 5-88 Face search

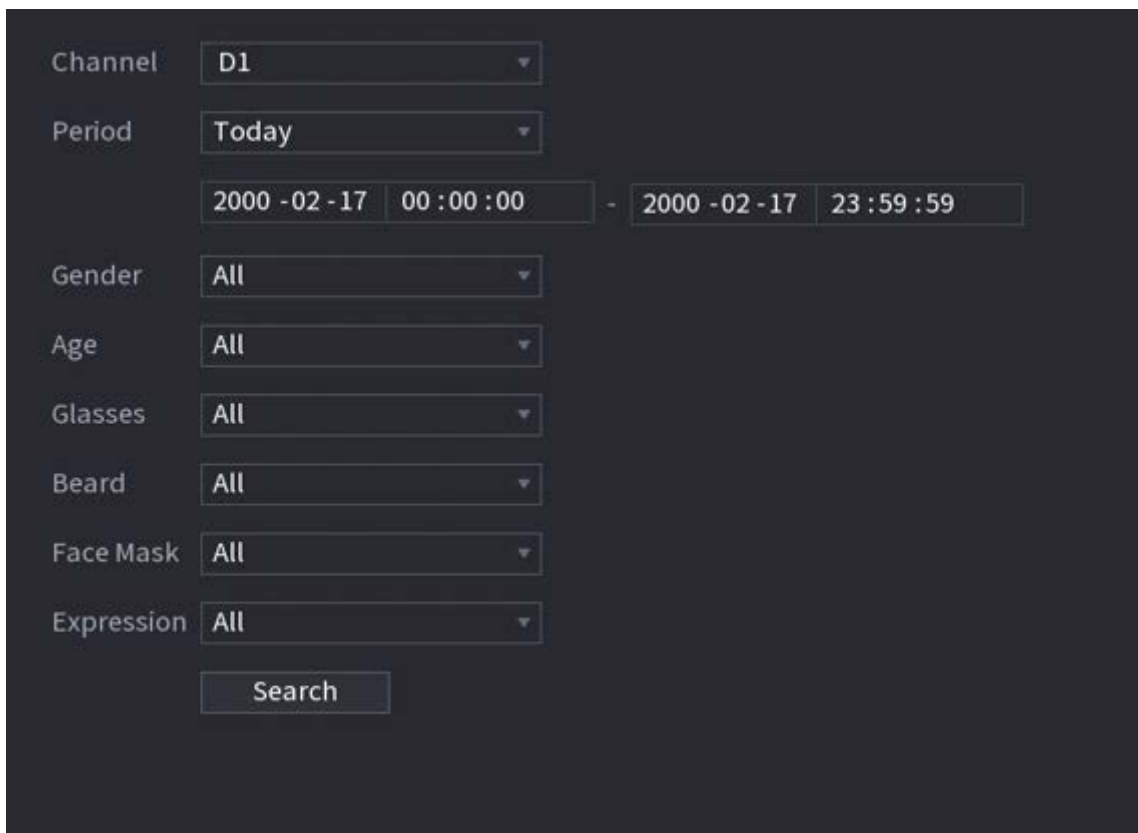

The screenshot shows a dark-themed search interface with the following fields and values:

- Channel: D1
- Period: Today
- Time Range: 2000 -02 -17 00 :00 :00 - 2000 -02 -17 23 :59 :59
- Gender: All
- Age: All
- Glasses: All
- Beard: All
- Face Mask: All
- Expression: All

A Search button is located at the bottom of the form.

Step 2 Select the channel, enter the start time and end time, and select the attributes.

Step 3 Click **Search**.

The results are displayed.



For privacy reason, the human faces in the image are intentionally blurred. The actual image is clear.

Figure 5-89 Search results

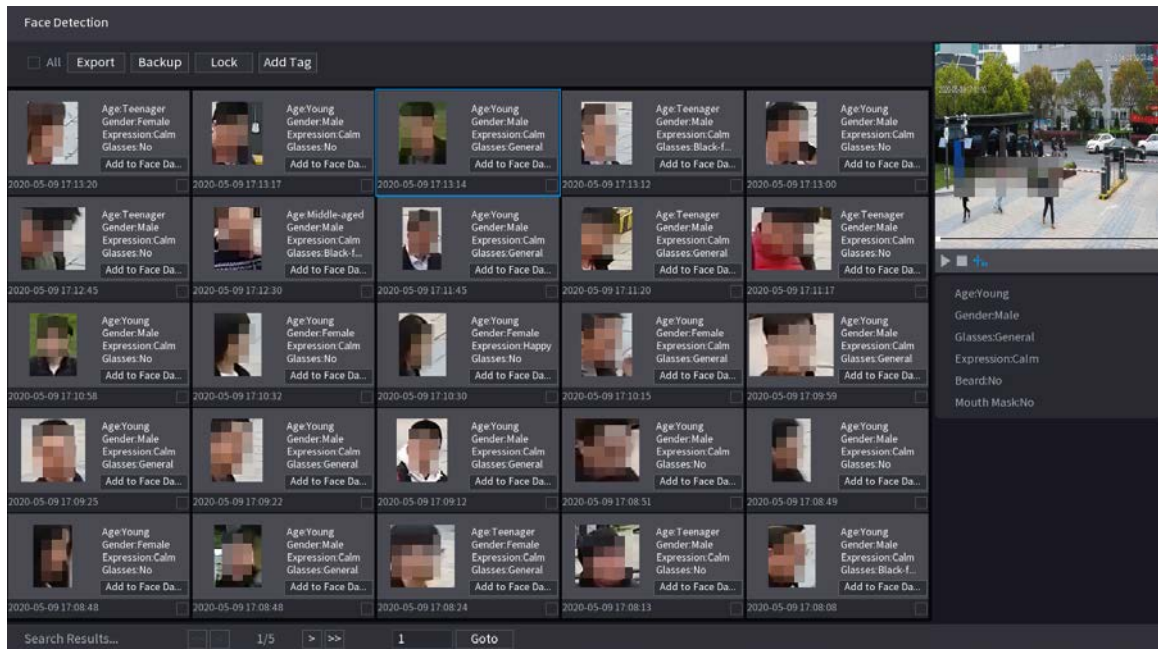

Related Operations

- Play related video.
Click a face and then click . The system plays back the video around the snapshot time.
- Export.
Click **Export** to export results in Excel format.
- Back up.
Select one or more images, click **Backup**, select the storage path and file type, and then click **Start** to back up the selected files to an external storage device.
- Lock.
Select one or more images and then click **Lock**. The locked files will not be overwritten.
- Add tags.
Select one or more images and then click **Add Tag**.
- Add to face database.
Click **Add to Face Database**, enter corresponding information, and then add the image to the face database.

Figure 5-90 Add face image to database

Register

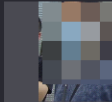

Name

Gender Male Female

Birthday Year M D

Province Anhui

Crede... ID Card

Region China

Add...

Cre...

1	Name	Register No.	Failed No.	Error No.
1	1	0	0	0

5.9.4 Face & Body Detection

After enabling face & body detection, you can view the face and body snapshots and related attributes on the live page.

5.9.4.1 Enabling Smart Plan

To use AI by camera, you need to enable the smart plan first. For details, see "5.9.2 Smart Plan".

5.9.4.2 Configuring Face & Body Detection

Background Information

Configure alarm rules for face and body detection.

Procedure

Step 1 Select **Main Menu > AI > Parameters > Face Detection**.

Figure 5-91 Face and body detection

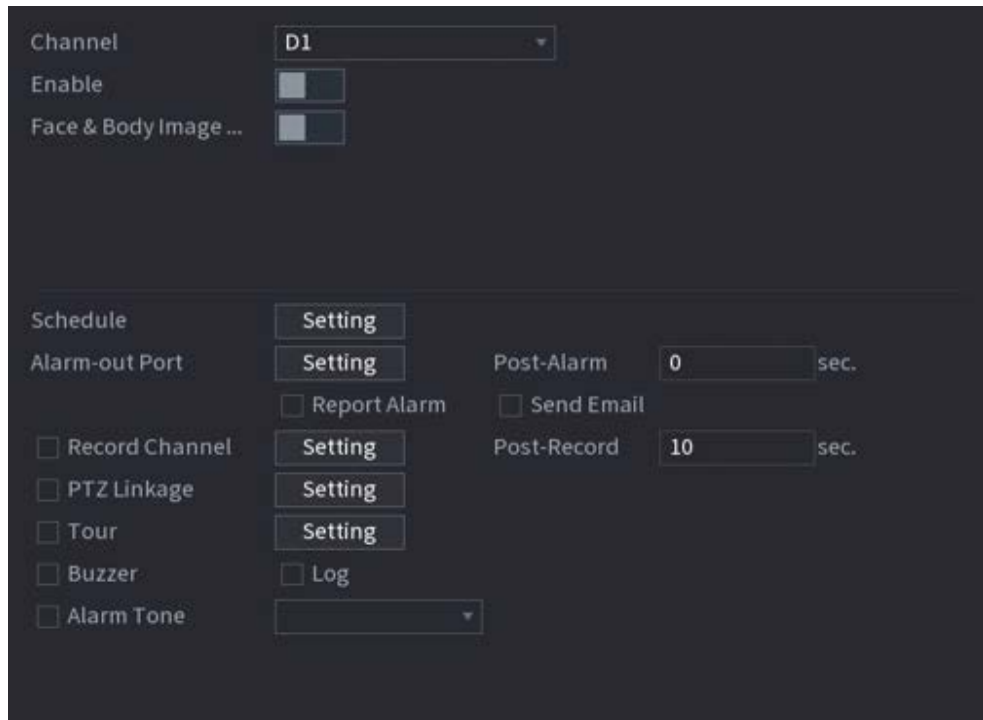

Step 2 Select a channel, and then click  to enable the function.

Step 3 Enable **Face & Body Image Enhancement** to improve detection efficiency.

Step 4 Configure target filters.

You can configure two target filters (maximum size and minimum size). The system triggers an alarm when the size of detected target is between the maximum size and the minimum size.

Step 5 Click **Setting** next to **Schedule** to configure the arming period.

The system triggers corresponding alarm actions only during the arming period.

- On the time line, drag to set the period.
- You can also click  to set the period.

Step 6 Configure alarm linkage actions. For details, see [Step 7](#).

Step 7 Click **Apply**.

5.9.4.3 AI Search (Face & Body Detection)

To search for face detection results, see "5.9.3.3 AI Search (Face Detection)". To search for body detection results, see "5.9.8.3.1 Human Detection".

5.9.5 Face Recognition

The system compares the detected faces with the faces in the database to judge whether the detected face belongs to the database. When the similarity reaches the defined threshold, an alarm is triggered.

5.9.5.1 Enabling Smart Plan

To use AI by camera, you need to enable the smart plan first. For details, see "5.9.2 Smart Plan".

5.9.5.2 Creating Face Database

Create face databases to manage face images for face recognition.

5.9.5.2.1 Creating Local Face Databases

You can create face databases on the Device to manage face images for face recognition by Device.

Procedure

Step 1 Select **Main Menu > AI > Database > Face Database Config.**

Figure 5-92 Face database configuration

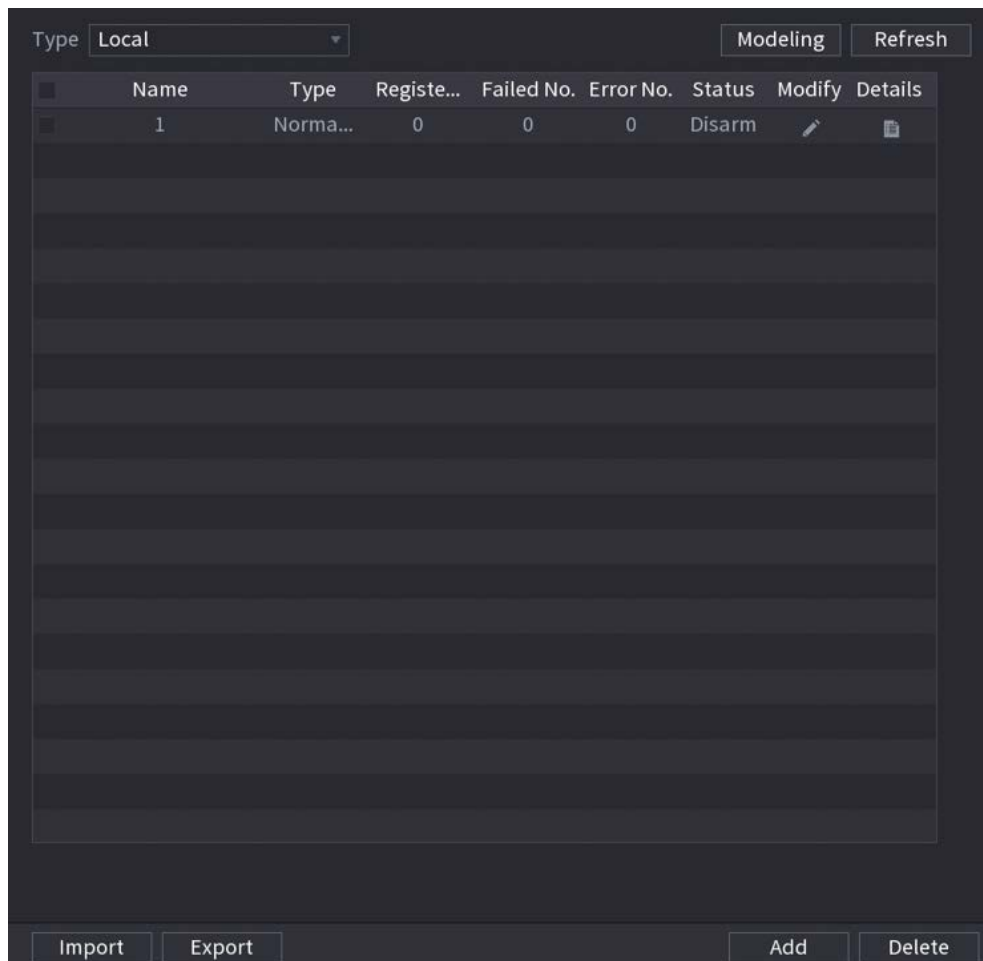

Step 2 Select **Local** as **Type**, and then click **Add**.

Figure 5-93 Add database

Step 3 Select **Normal Database** from the **Type** list, and then enter database name.

Step 4 Click **OK**.

5.9.5.2.2 Creating Remote Face Databases

The Device can get face databases from the remote devices, and also allows creating face databases for remote devices. The remote device face database is suitable for face recognition by Camera.

Procedure

Step 1 Select **Main Menu > AI > Database > Face Database Config**.

Step 2 Select **Remote** as **Type**, select a channel and then click **Add**.

Step 3 Enter database name.

Step 4 Click **OK**.

5.9.5.2.3 Creating the Passerby Database

Background Information

If you use the passerby database for alarm linkage, when the detected face is not in the face database, the system automatically captures the face image, and then save it to the passerby database.



This function is available on select models.

Procedure

Step 1 Select **Main Menu > Database > Face Database Config**.

Step 2 Select **Local** as **Type**, and then click **Add**.



You can create only one passerby database.

Figure 5-94 Add database

Step 3 Select **Passerby Database** from the **Type** list, and then configure other parameters.

Table 5-26 Passerby database parameters

Parameter	Description
Name	Enter a name for the passerby database.
Number of Images	Configure the number of images that the database can contain.
Storage Full	Select the storage strategy when space is full. <ul style="list-style-type: none"> • Stop: No more images can be added. • Overwrite: The newest images overwrite the oldest images. Back up the old images as necessary.
Time	Set the period in which the system removes duplicate face images from the database.

Step 4 Click **OK**.

5.9.5.3 Adding Images to Face Database

You can add face images to the existing databases one by one or in batches.

5.9.5.3.1 Adding Face Images One by One

Background Information

You can add one face image to the database. It is for the scenario that the registered human face picture amount is small.

Procedure

Step 1 Select **Main Menu > AI > Database > Face Database Config**.

Step 2 Click of the database that you want to configure.

Figure 5-95 Databases details

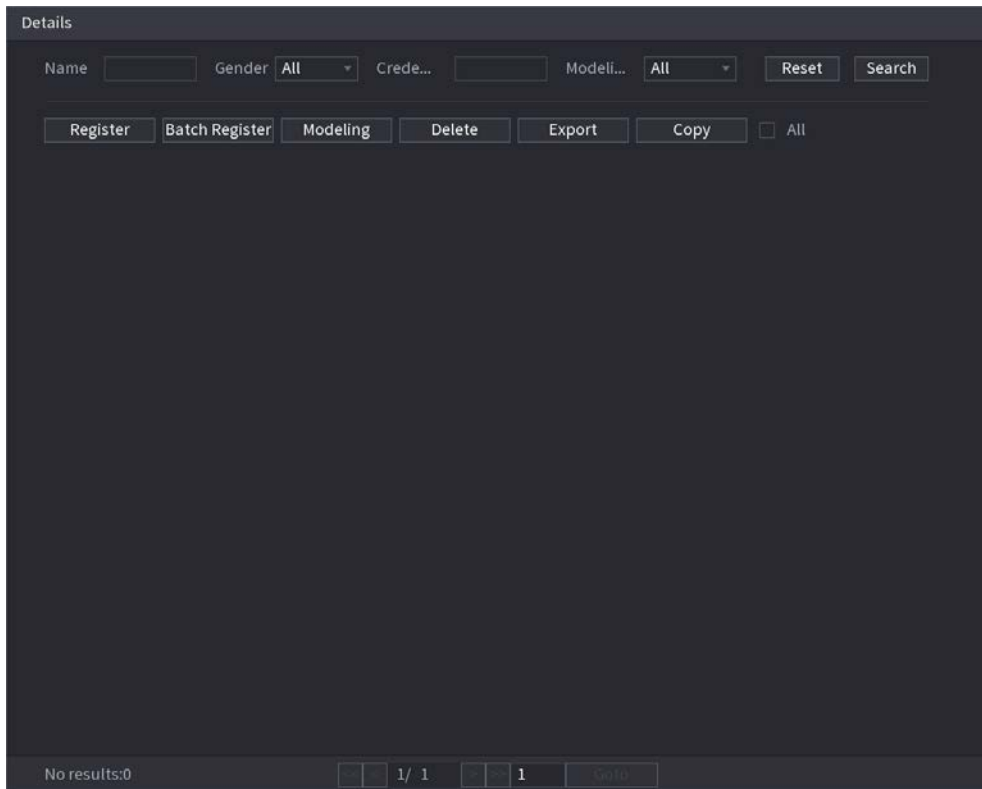

Step 3 Click **Register**.

Figure 5-96 Register

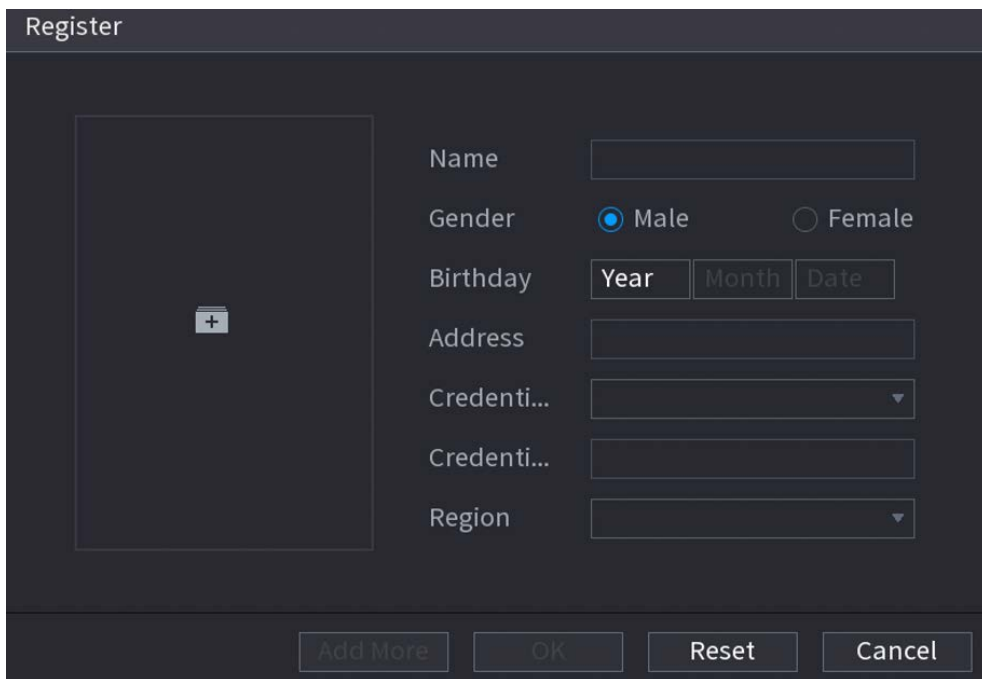

Step 4 Click  to add a face image.

Figure 5-97 Browse

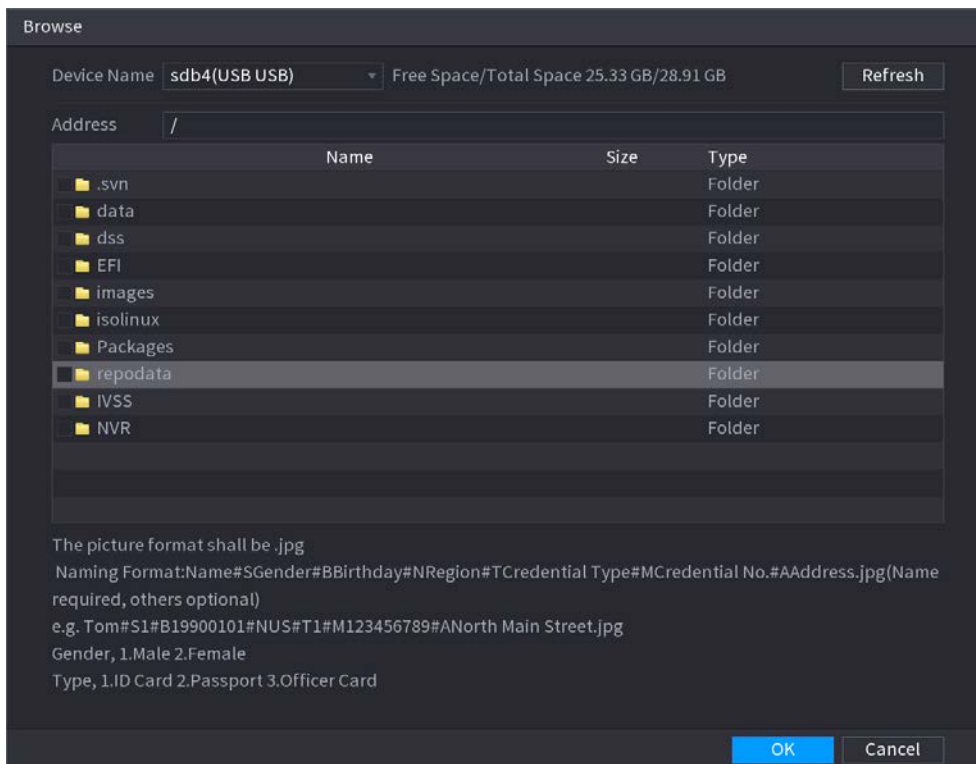

Step 5 Select a face image and then enter the registration information.

Step 6 Click **OK**.

The system prompts the registration is successful.

Step 7 On the **Details** page, click **Search**.

The system prompts modeling is successful.



If the system prompts modeling is in process, wait a while and then click **Search** again. If modeling failed, the registered face image cannot be used for face recognition.

Related Operations

- Edit registration information.

Click  to modify the registration information.

- Model face images.

The face images are modeled automatically after added to face database. You can also model face images manually.

- ◇ On the **Database Config** page, select a database, and then click **Modeling** to model all the face images in the database.
- ◇ On the **Details** page, select one or more face images, and then click **Modeling** to model the selected images.

- Export face images.

Select one or more face images, and then click **Export**.

- Delete face images.

Select one or more face images, and then click **Delete**.

5.9.5.3.2 Adding Face Images in Batches

Background Information

The system supports batch add if you want to import several human face image at the same time.

Procedure

Step 1 Give a name to the face picture by referring to the following table.

Table 5-27 Naming rule

Naming format	Description
Name	Enter the name.
Gender	Enter 1 or 2. 1 represents male, and 2 represents female.
Birth day	Enter numbers in the format of yyyy-mm-dd.
Region	Enter the abbreviation of region. For example, CN for China.
Credential Type	1 represents ID card; 2 represents passport; 3 represents officer card.
Credential No.	Enter the credential number.
Address	Enter the address.

Step 2 Select **Main Menu > AI > Database > Face Database Config.**

Step 3 Click  of the database that you want to configure.

Step 4 Click **Batch Register.**

Figure 5-98 Batch register

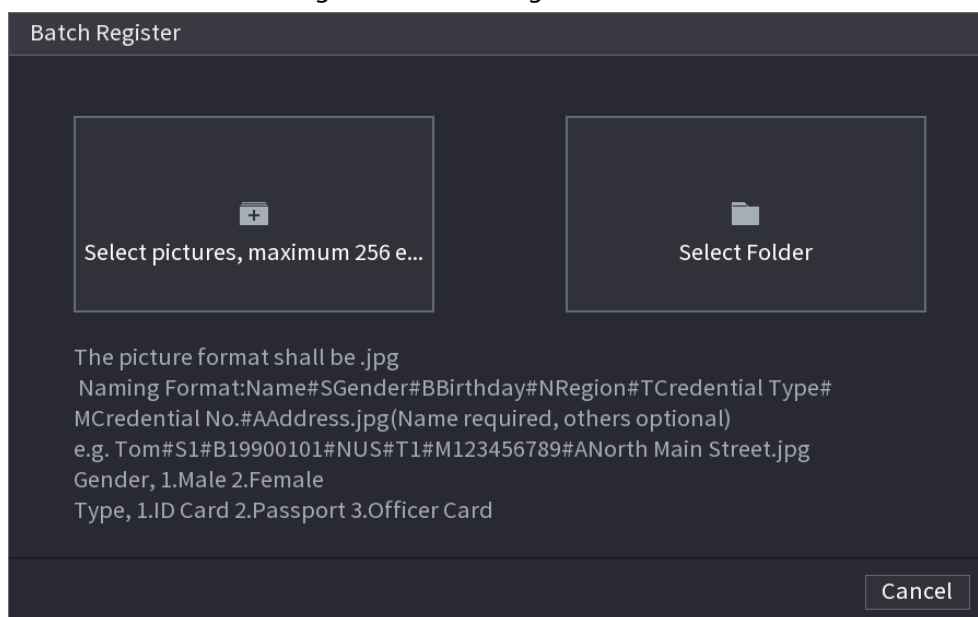

Step 5 Click  or  to import face images.

Step 6 Click **OK.**

Related Operations

- Edit registration information.
Click  to modify the registration information.
- Model face images.
The face images are modeled automatically after added to face database. You can also model

face images manually.

- ◇ On the **Database Config** page, select a database, and then click **Modeling** to model all the face images in the database.
- ◇ On the **Details** page, select one or more face images, and then click **Modeling** to model the selected images.
- Export face images.
Select one or more face images, and then click **Export**.
- Delete face images.
Select one or more face images, and then click **Delete**.

5.9.5.4 Configuring Face Recognition

Background Information

Configure alarm rules for face recognition.

5.9.5.4.1 Configuring AI by Recorder

Prerequisites

Make sure the face detection function is enabled at corresponding channel.

Procedure

Step 1 Select **Main Menu > AI > Parameters > Face Recognition**.

Step 2 Select the channel, enable the function, and select **AI by Recorder** in the **Type** list.

Figure 5-99 AI by recorder

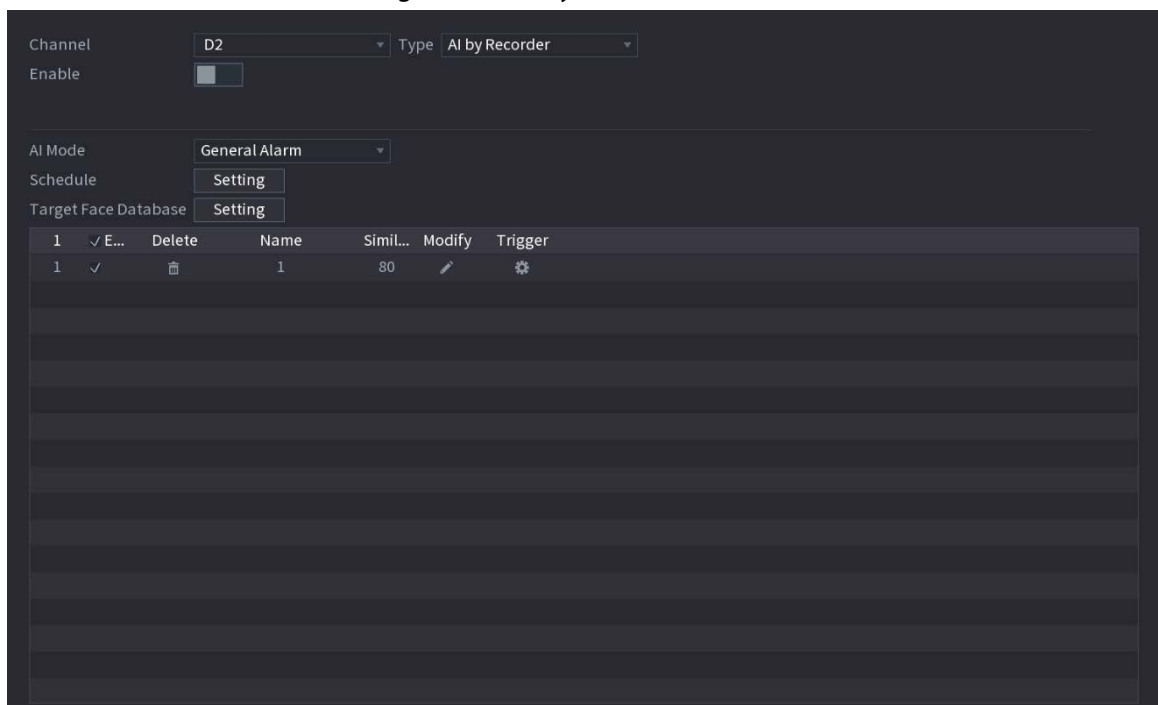

Step 3 Click **Setting** next to **Schedule** to configure arming periods. The corresponding alarm actions are linked by the alarm events triggered during armed period.

Step 4 Arm target face database.

- **General Alarm:** The alarm is triggered when the similarity of detected faces reaches

the defined value.





1. Select **General Alarm** in **AI Mode**.
 2. Click **Setting** next to **Target Face Database**.
 3. Select the face database that you want to arm, and then click **OK**.
 4. Click  to modify similarity.
 5. Click  to configure alarm linkages.
- **Stranger Alarm:** The alarm is triggered when the similarity of detected faces does not reach the defined value.

Figure 5-100 Stranger alarm (AI by recorder)

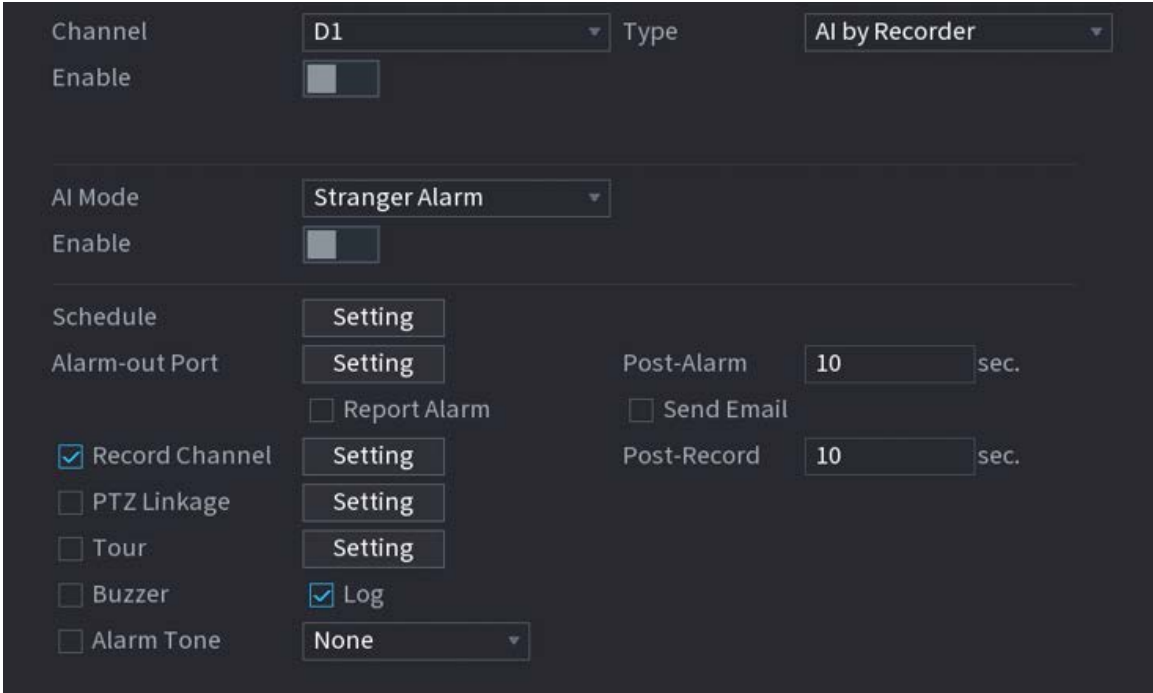

1. Select **Stranger Alarm** in **AI Mode**.
2. Click  enable the function.
3. Configure the alarm linkage actions. For details on alarm linkage, see Table 5-43.

Step 5 Click **Apply**.

5.9.5.4.2 Configuring AI by Camera

Prerequisites

Make sure the connected camera supports face recognition.

Procedure

- Step 1 Select **Main Menu** > **AI** > **Parameters** > **Face Recognition**.
- Step 2 Select the channel, enable the function, and select **AI by Camera** in the **Type** list.

Figure 5-101 AI by camera

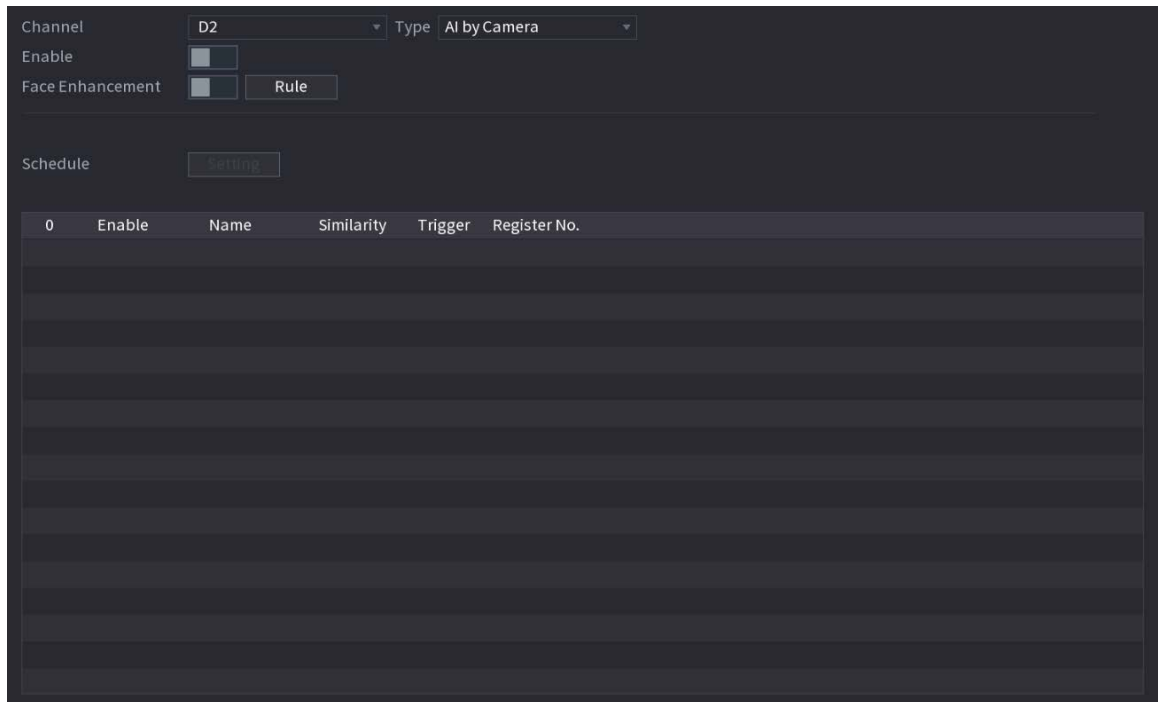

Step 3 Enable **Face Enhancement** to make the faces displayed more clear.

Step 4 Click **Rule** to draw areas to filter the target.

You can configure two target filters (maximum size and minimum size). When the target is smaller than the minimum size or larger than the maximum size, no alarms will be activated.

Step 5 Select target face database, and then click  to configure alarm linkage. For details on alarm linkage, see Table 5-43.

Step 6 Click **Apply**.

5.9.5.5 AI Search (Face Recognition)

You can search for the face recognition results by attributes or by image.

5.9.5.5.1 Search by Attributes

Procedure

Step 1 Select **Main Menu > AI > AI Search > Face Recognition > Search by Attributes**.

Figure 5-102 Search by attributes

Step 2 Select the channel and set the parameters including start time, end time, gender, age, glasses, beard, mask, name and similarity.

Step 3 Click **Search**.





The faces in the image are intentionally blurred for privacy protection. The actual images are clear.

Figure 5-103 Search results

Related Operations

- Play back video.
Click an image, and then click to play back the related video.
During playback, you can:
 - ◇ Click to pause.

- ◇ Click  to stop.
- ◇ Click  to display AI rule. The icon changes to .
- Add tags.
Select one or more images, and then click **Add Tag**.
- Lock.
Select one or more images, and then click **Lock**. The locked files will not be overwritten.
- Export.
Select one or more images, and then click **Export** to export selected search results in excel.
- Back up.
Select one or more images, click **Backup**, select the storage path and file type, and then click **Start** to export files to external storage device.

5.9.5.5.2 Search by Image

Procedure

- Step 1 Select **Main Menu > AI > AI Search > Face Recognition > Search by Picture**.

Figure 5-104 Search by image

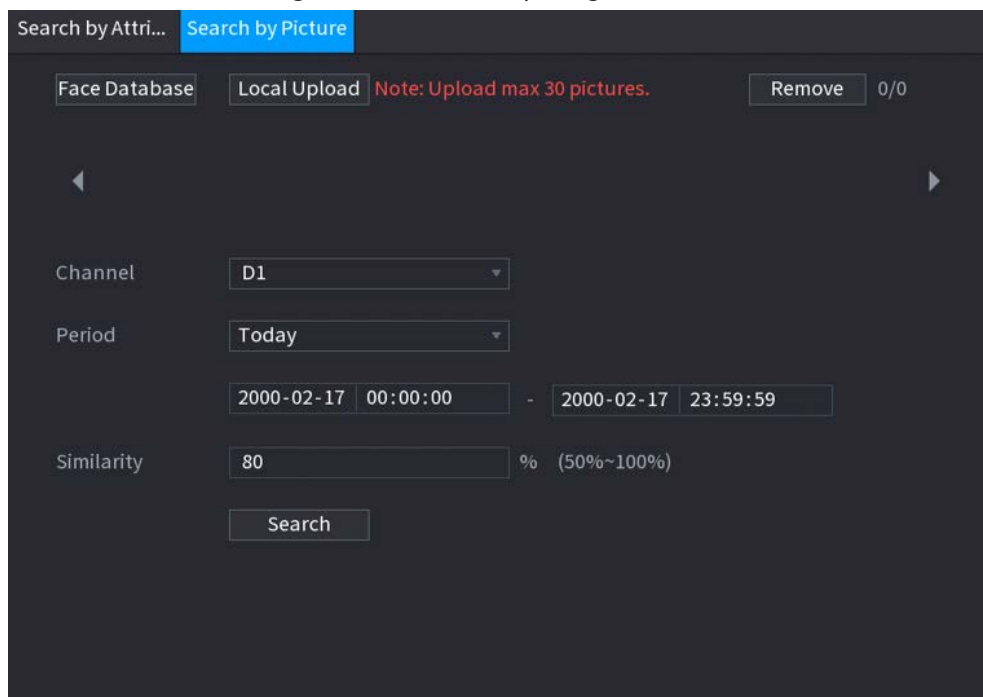

- Step 2 Upload face images.
- **Face Database:** Upload face images from database.
 - **Local Upload:** Upload face images from external storage device.
- Step 3 Select the image used to search and then set the parameters including channel, start time, end time, gender, age, glasses, beard, mask, and similarity.
- Step 4 Click **Search**.
The search results are displayed.

Related Operations

- Play back video.
Click an image, and then click  to play back the related video.

During playback, you can:

- ◇ Click to pause.
- ◇ Click to stop.
- ◇ Click to display AI rule. The icon changes to .
- Add tags.
Select one or more images, and then click **Add Tag**.
- Lock.
Select one or more images, and then click **Lock**. The locked files will not be overwritten.
- Export.
Select one or more images, and then click **Export** to export selected search results in excel.
- Back up.
Select one or more images, click **Backup**, select the storage path and file type, and then click **Start** to export files to external storage device.

5.9.5.5.3 Report Query

Background Information

You can search for and export face statistics.



- The statistics might be overwritten when the storage space runs out. Back up in time.
- When you restore the Device to factory settings, all the data except data in the external storage device will be cleared. You can clear the data in the external storage device through formatting or other methods.

Procedure

Step 1 Select **Main Menu > AI > Report Query > Face Statistics**.

Figure 5-105 Face statistics

Step 2 Select the report type, start time and end time, and then click **Search**.

Related Operations

- Switch chart type.
Click **Bart Chart** or **Line Chart** to switch the chart type.
- Export.
Select file type, and then click **Export** to export the report in picture or csv format.

5.9.6 IVS

The IVS function processes and analyzes the images to extract the key information to match the specified rules. When the detected behaviors match the rules, the system activates alarms.



- This function is available on select models.
- IVS and face detection cannot be enabled at the same time.

5.9.6.1 Enabling Smart Plan

To use AI by camera, you need to enable the smart plan first. For details, see "5.9.2 Smart Plan".

5.9.6.2 Configuring IVS

5.9.6.2.1 Tripwire

Background Information

When the detection target crosses the warning line along the set direction, the system performs an alarm linkage action.

Procedure

Step 1 Select **Main Menu > AI > Parameters > IVS**.

Figure 5-106 IVS

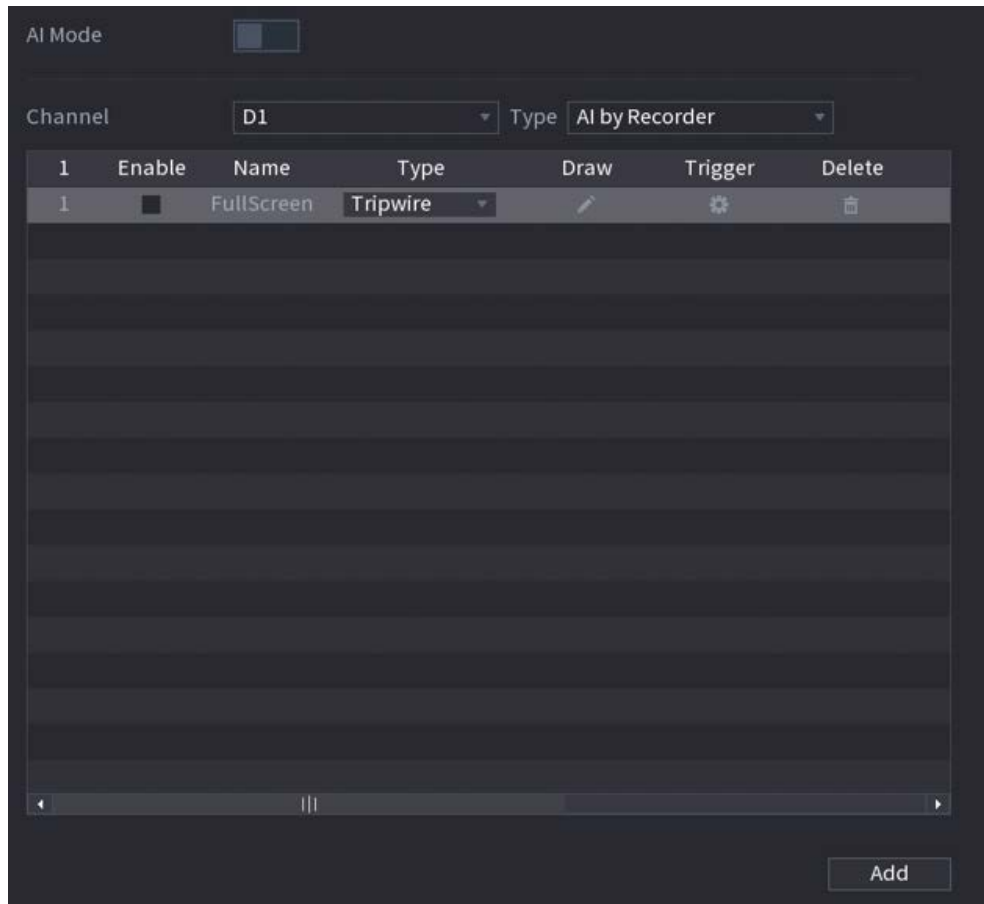

Step 2 Select channel and AI type.

Step 3 Click **Add** to add a rule.

Step 4 On the **Type** list, select **Tripwire**.

Step 5 Draw the detection rule.

- 1) Click  to draw a straight line or a curve on the surveillance video image. Right-click the image to stop drawing.

Figure 5-107 Tripwire (AI by camera)

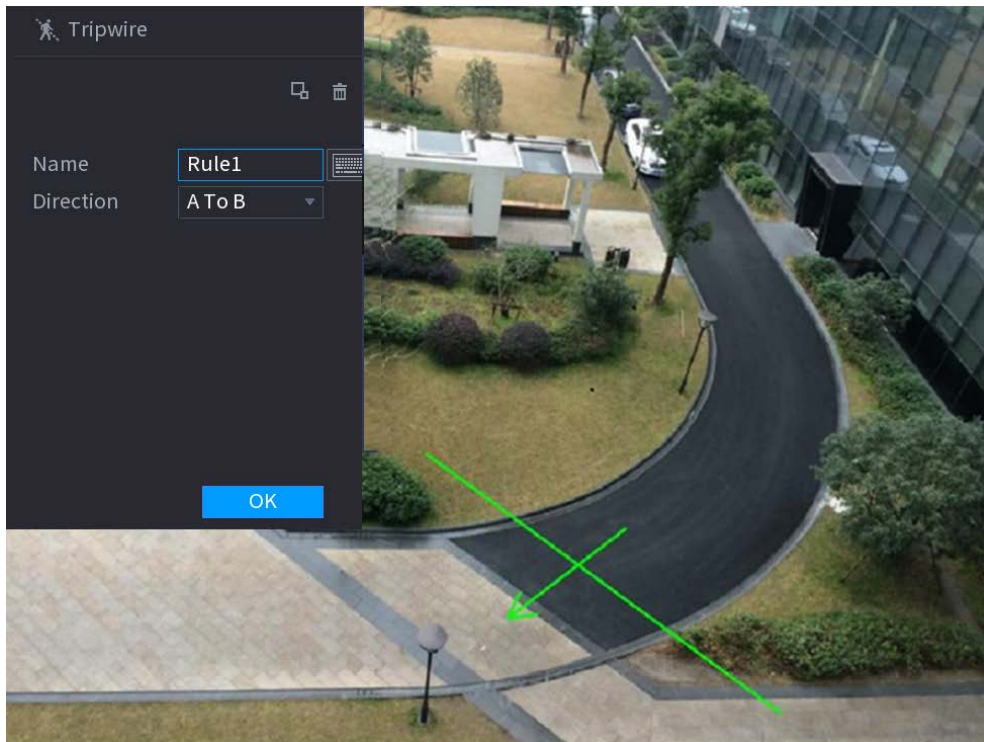
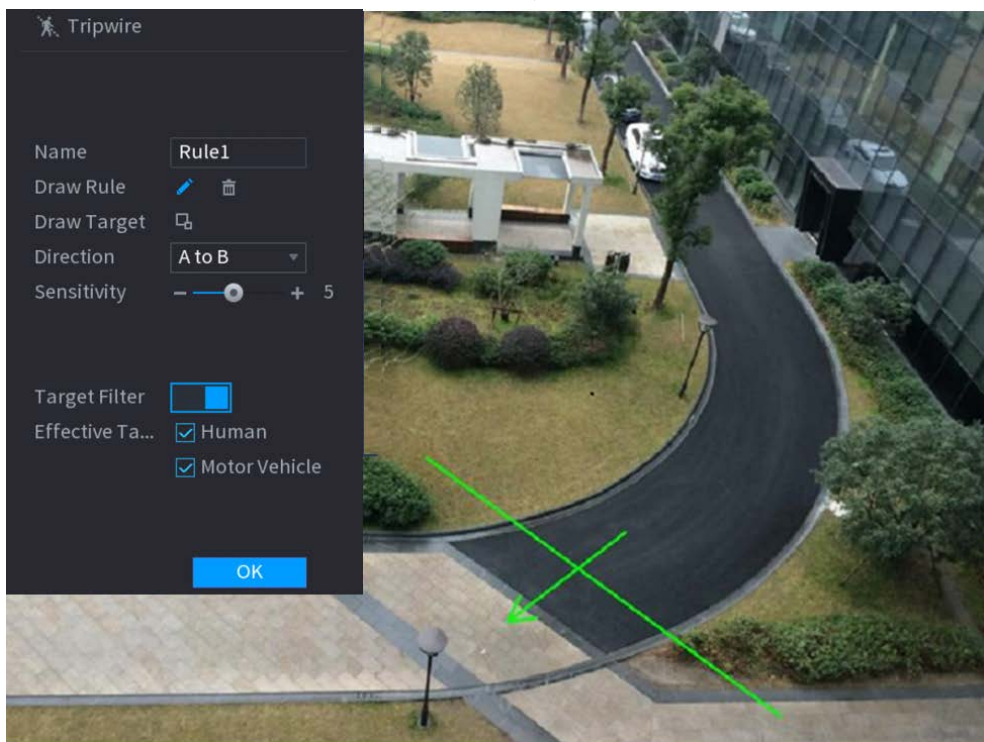

Figure 5-108 Tripwire (AI by recorder)





- 2) Click  to draw the minimum size or maximum size to filter the target.
The system triggers an alarm only when the size of detected target is between the maximum size and the minimum size.
- 3) Configure the parameters.

Table 5-28 Tripwire parameters

Parameter	Description
Name	Customize the rule name.
Direction	Set the tripwire direction, including A→B, B→A and A↔B.
Target Filter	Click  and then select effective target. With Human and Motor Vehicle selected by default, the system automatically identifies the person and motor vehicle appeared within the monitoring range.

4) Click **OK**.

Step 6 Configure alarm schedule and linkage.

Figure 5-109 Schedule and alarm linkage

1) Click .

2) Click **Setting** next to **Schedule** to configure the alarm period.

The system performs linkage actions only for alarms during the arming period.

- On the time line, drag to set the period.
- You can also click  to set the period.

3) Configure alarm linkage. For details, see Table 5-43.

4) Click **Apply**.

Step 7 Select the **Enable** checkbox and then click **Apply**.

5.9.6.2.2 Intrusion

Background Information

When the detection target passes the edge of the monitoring area, and enters, leaves or traverses the monitoring area, the system performs an alarm linkage action.

Procedure

Step 1 Select **Main Menu > AI > Parameters > IVS**.

Figure 5-110 IVS

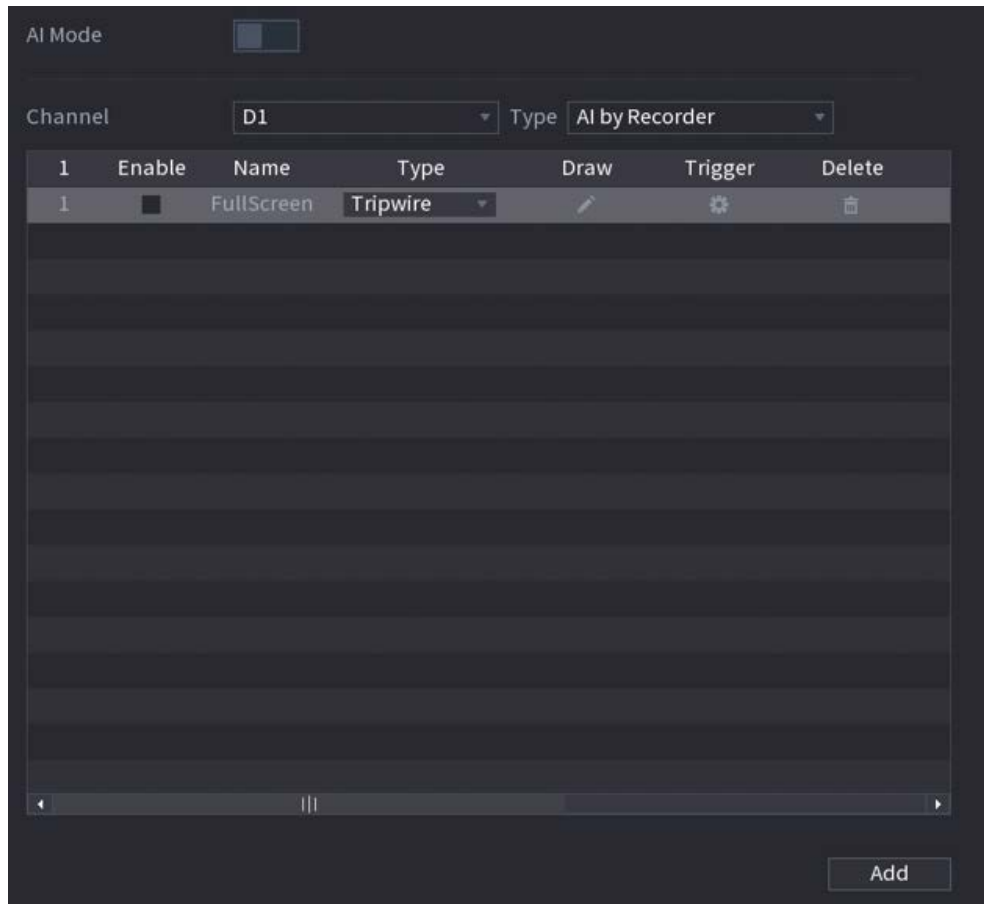

Step 2 Select channel and AI type.

Step 3 Click **Add** to add a rule.

Step 4 On the **Type** list, select **Intrusion**.

Step 5 Draw the detection rule.

- 1) Click  to draw the rule on the surveillance video image. Right-click the image to stop drawing.

Figure 5-111 Intrusion (AI by camera)

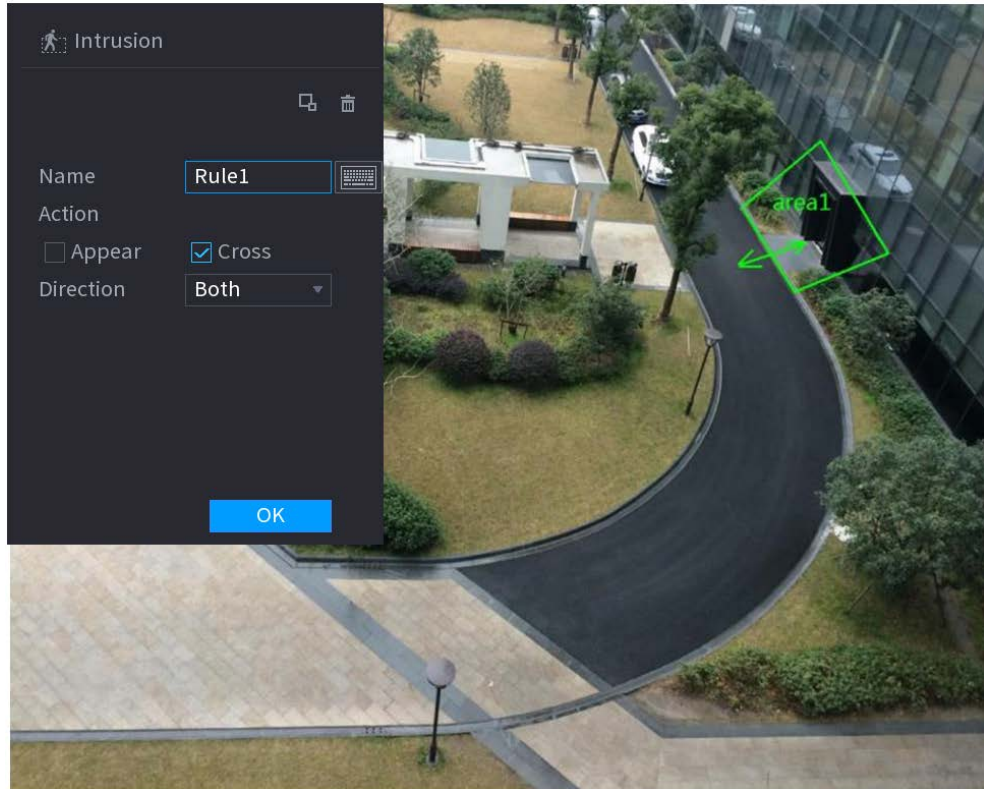
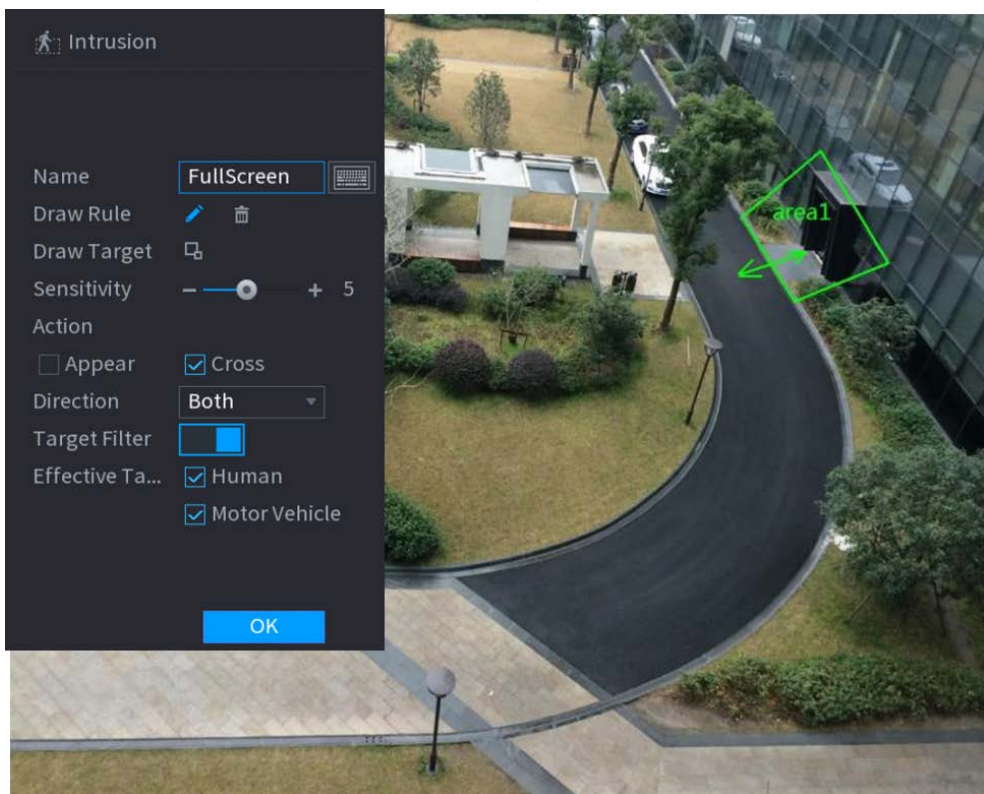

Figure 5-112 Intrusion (AI by recorder)





- 2) Click  to draw the minimum size or maximum size to filter the target.
The system triggers an alarm only when the size of detected target is between the maximum size and the minimum size.
- 3) Configure the parameters.

Table 5-29 Intrusion parameters

Parameter	Description
Name	Customize the rule name.
Action	Set the intrusion action, including appear and crossing area.
Direction	Set the direction to cross the area, including enter, exit and both.
Target Filter	Click  and then select effective target. With Human and Motor Vehicle selected by default, the system automatically identifies the person and motor vehicle appeared within the monitoring range.

4) Click **OK**.

Step 6 Configure alarm schedule and linkage.

Figure 5-113 Schedule and alarm linkage

1) Click .

2) Click **Setting** next to **Schedule** to configure the alarm period.

The system performs linkage actions only for alarms during the arming period.

- On the time line, drag to set the period.
- You can also click  to set the period.

3) Configure alarm linkage. For details, see Table 5-43.

4) Click **Apply**.

Step 7 Select **Enable** checkbox and then click **Apply**.

5.9.6.2.3 Abandoned Object Detection

Background Information

The system generates an alarm when there is an abandoned object in the specified zone.

Procedure

Step 1 Select **Main Menu > AI > Parameters > IVS**.

Figure 5-114 IVS

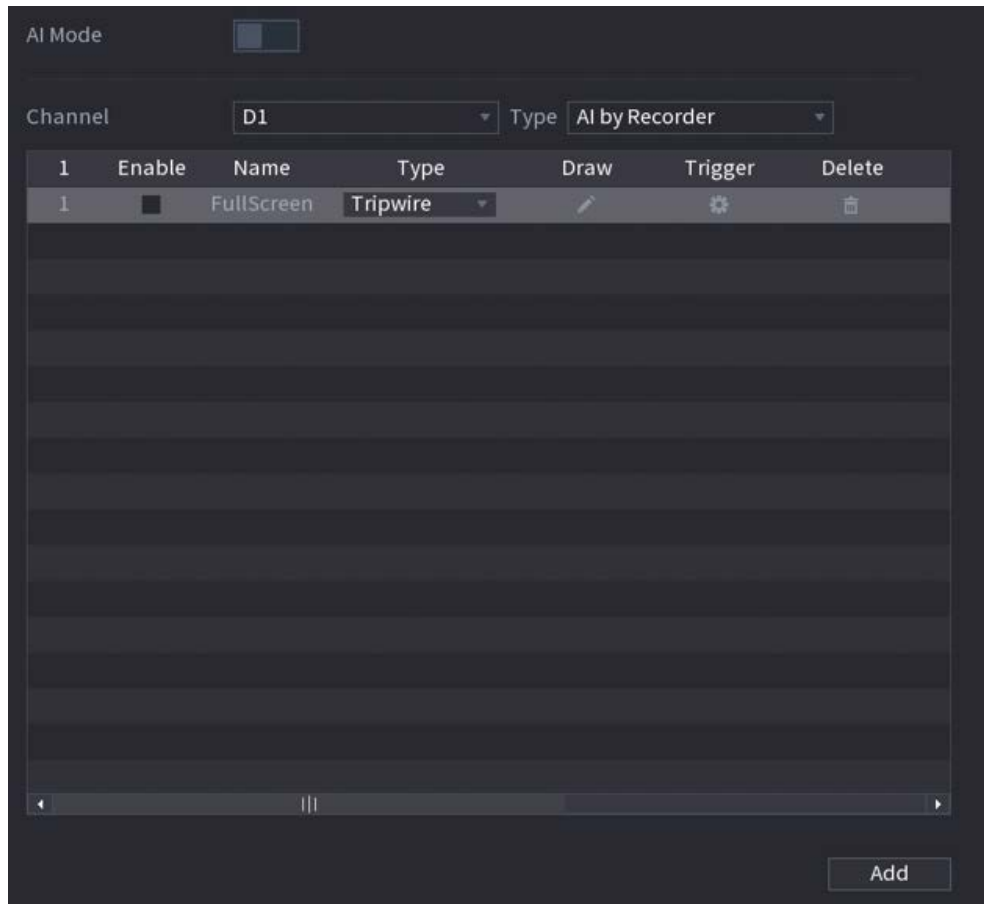

Step 2 Select channel and AI type.

Step 3 Click **Add** to add a rule.

Step 4 On the **Type** list, select **Abandoned Object**.

Step 5 Draw the detection rule.



- 1) Click  to draw a rectangle on the surveillance video image. Right-click the image to stop drawing.

Figure 5-115 Abandoned object rule

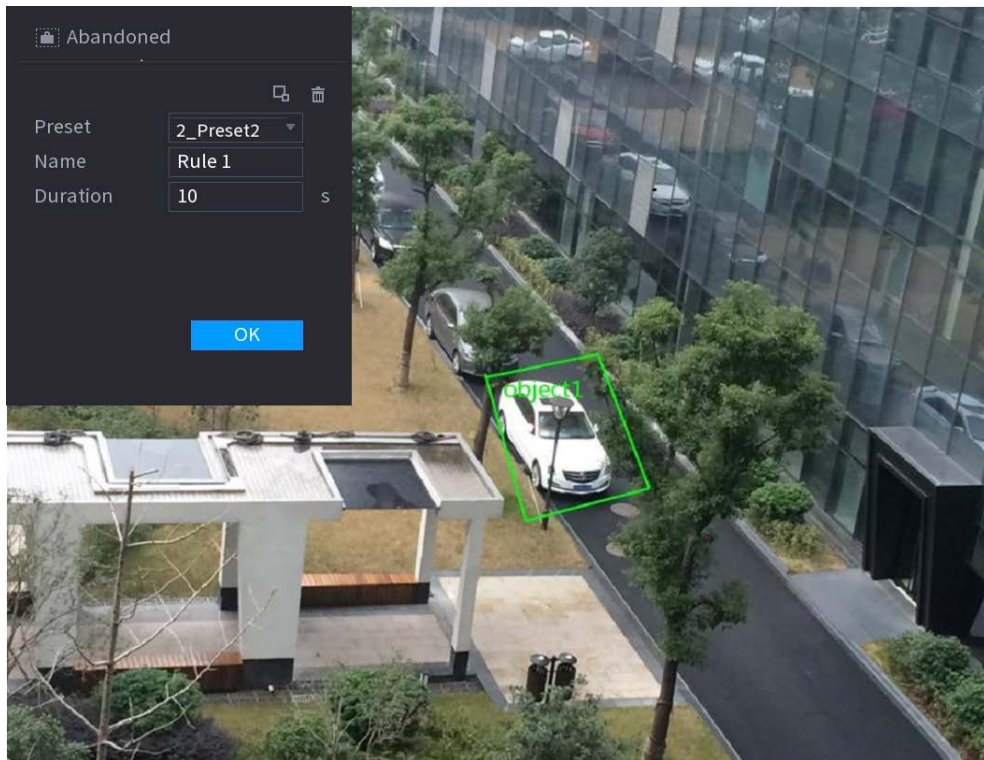

2) Click  to draw the minimum size or maximum size to filter the target.

The system triggers an alarm only when the size of detected target is between the maximum size and the minimum size.

3) Configure parameters.

Table 5-30 Parameters of abandoned object detection



Parameter	Description
Preset	Select a preset you want to use IVS.
Name	Customize the rule name.
Duration	The system generates an alarm once the object is in the zone for the defined period.

4) Click **OK**.

Step 6 Configure alarm schedule and linkage.

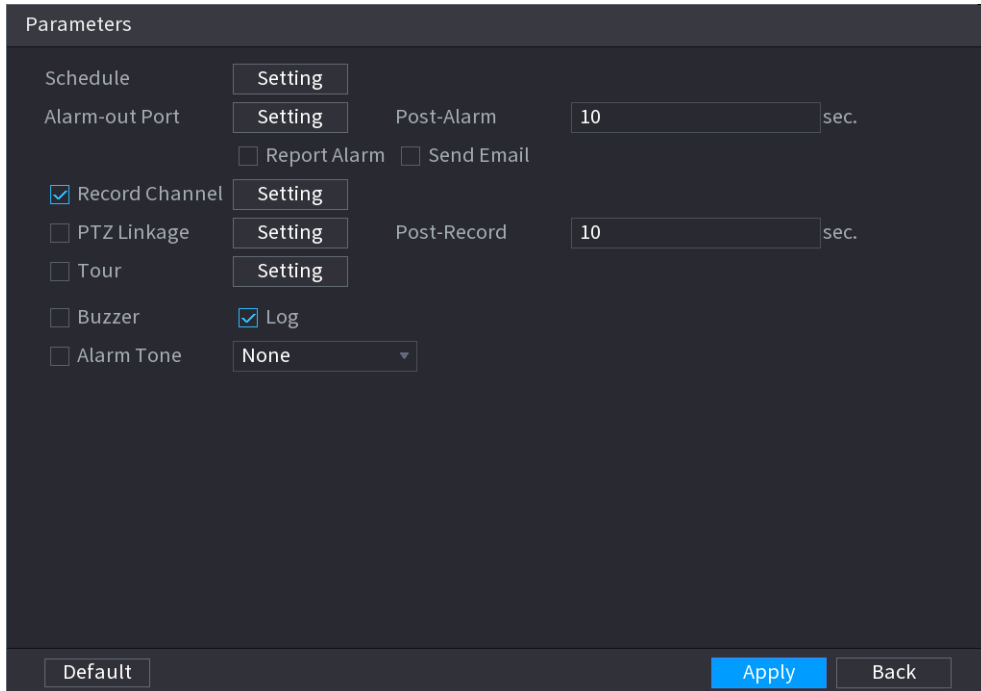
Figure 5-116 Schedule and alarm linkage



- 1) Click .
- 2) Click **Setting** next to **Schedule** to configure the alarm period.
 - The system performs linkage actions only for alarms during the arming period.
 - On the time line, drag to set the period.
 - You can also click  to set the period.
- 3) Configure alarm linkage. For details, see Table 5-43.
- 4) Click **Apply**.

Step 7 Select **Enable** checkbox and then click **Apply**.

5.9.6.2.4 Fast Moving

Background Information

You can detect the fast moving object in the specified zone.

Procedure

Step 1 Select **Main Menu > AI > Parameters > IVS**.

Figure 5-117 IVS

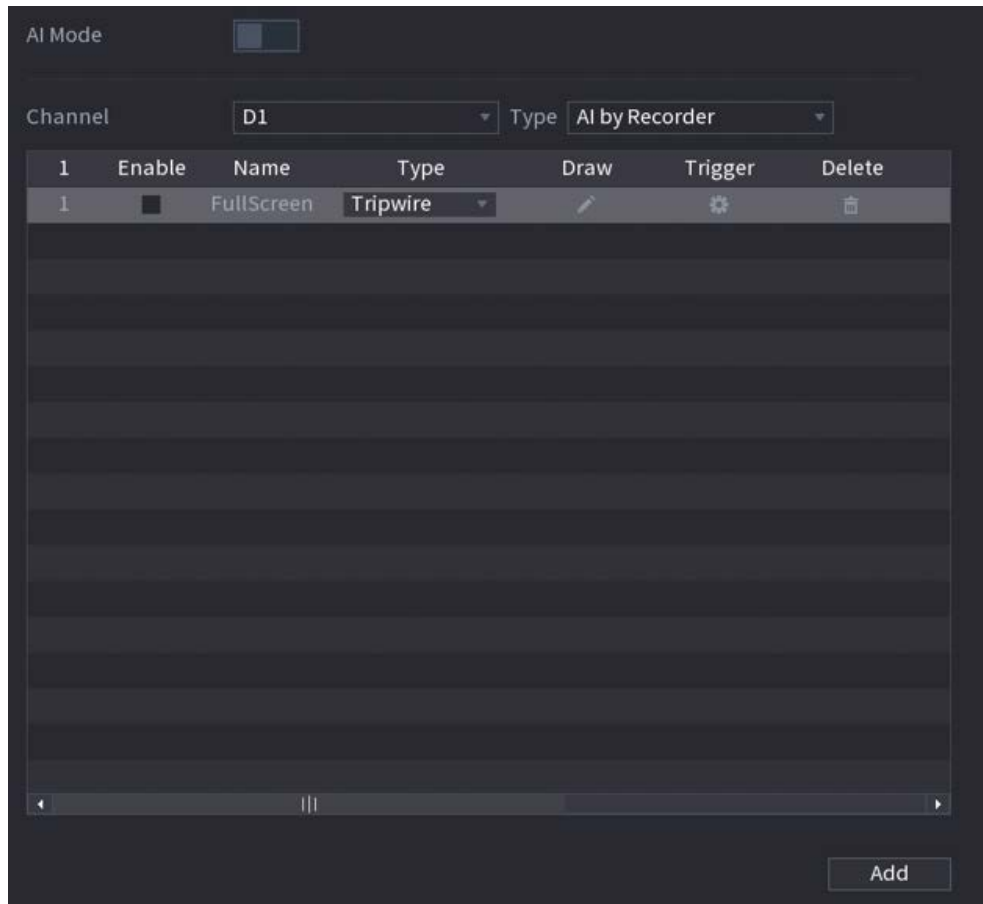

Step 2 Select channel and AI type.

Step 3 Click **Add** to add a rule.

Step 4 On the **Type** list, select **Fast Moving**.

Step 5 Draw the detection rule.



- 1) Click  to draw a rectangle on the surveillance video image. Right-click the image to stop drawing.

Figure 5-118 Fast moving

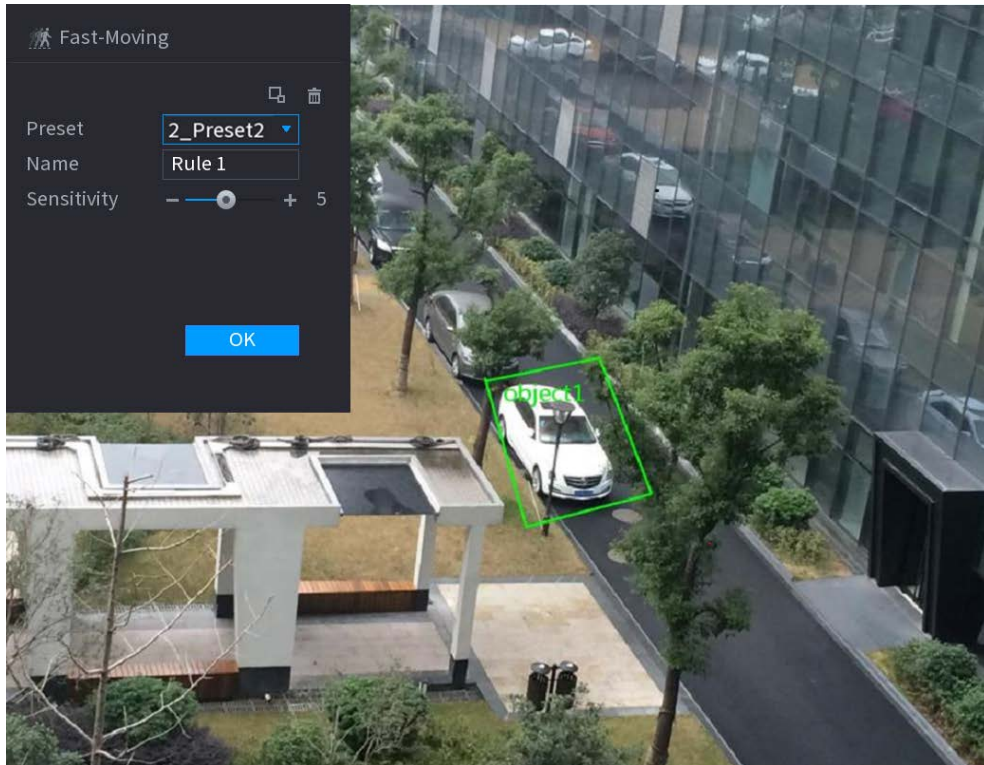

2) Click  to draw the minimum size or maximum size to filter the target.

The system triggers an alarm only when the size of detected target is between the maximum size and the minimum size.

3) Configure parameters.

Table 5-31 Fast moving parameters



Parameter	Description
Preset	Select a preset you want to use IVS.
Name	Customize the rule name.
Sensitivity	You can set alarm sensitivity. The higher the value, the easier to detect a fast moving object but meanwhile the higher false alarm rate.

4) Click **OK**.

Step 6 Configure alarm schedule and linkage.

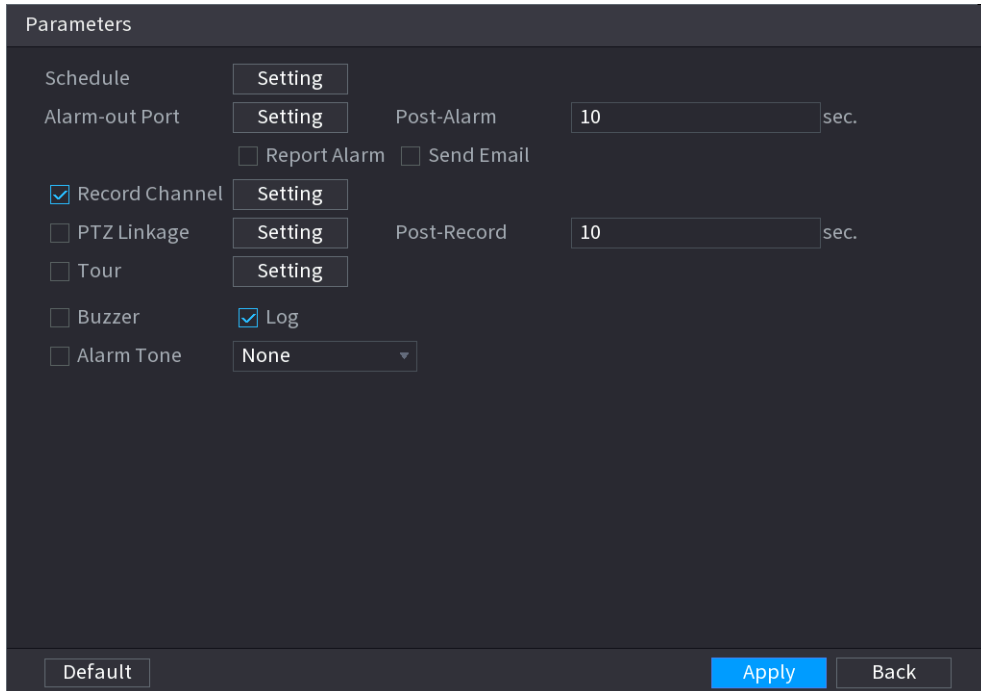
Figure 5-119 Schedule and alarm linkage



- 1) Click .
- 2) Click **Setting** next to **Schedule** to configure the alarm period.
The system performs linkage actions only for alarms during the arming period.
 - On the time line, drag to set the period.
 - You can also click  to set the period.
- 3) Configure alarm linkage. For details, see Table 5-43.
- 4) Click **Apply**.

Step 7 Select **Enable** checkbox and then click **Apply**.

5.9.6.2.5 Parking

Background Information

When the detection target stays in the monitoring area longer than the set duration, the system performs alarm linkage action.

Procedure

Step 1 Select **Main Menu > AI > Parameters > IVS**.

Figure 5-120 IVS

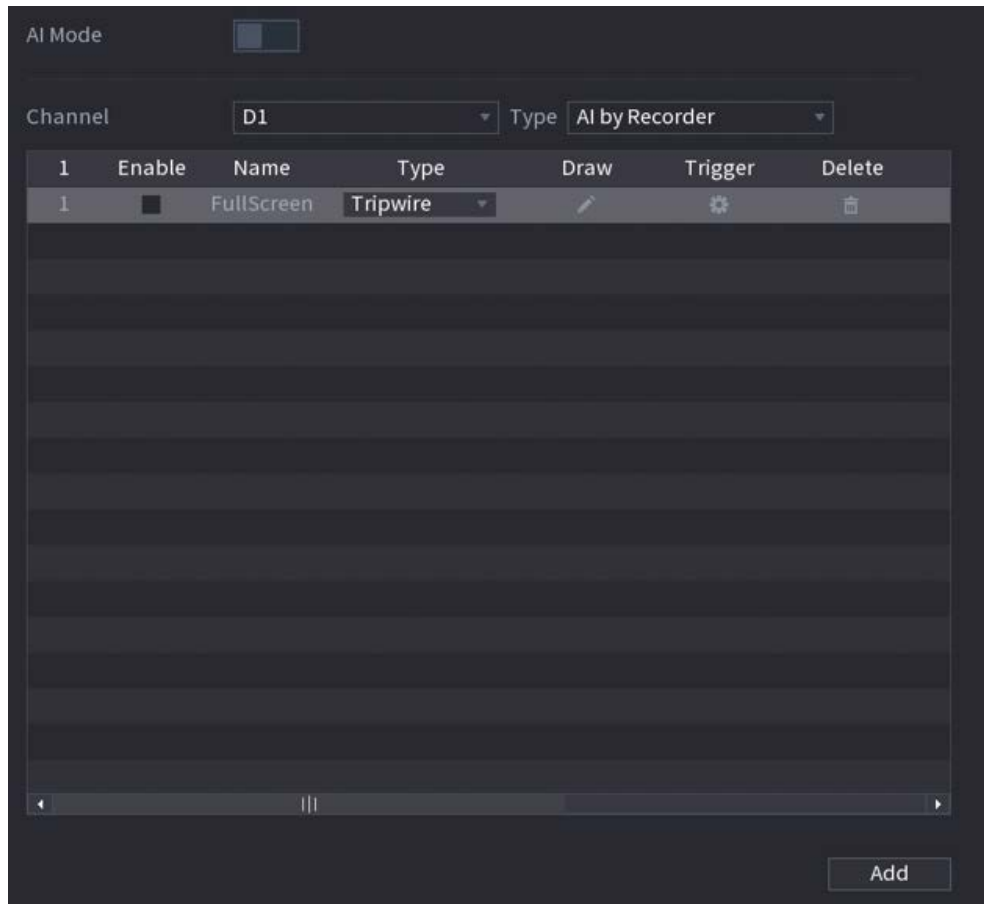

Step 2 Select channel and AI type.

Step 3 Click **Add** to add a rule.

Step 4 On the **Type** list, select **Parking**.

Step 5 Draw the detection rule.

- 1) Click  to draw a rectangle on the surveillance video image. Right-click the image to stop drawing.

Figure 5-121 Parking



- 2) Click  to draw the minimum size or maximum size to filter the target.
The system triggers an alarm only when the size of detected target is between the maximum size and the minimum size.
- 3) Configure parameters.

Table 5-32 Parking parameters

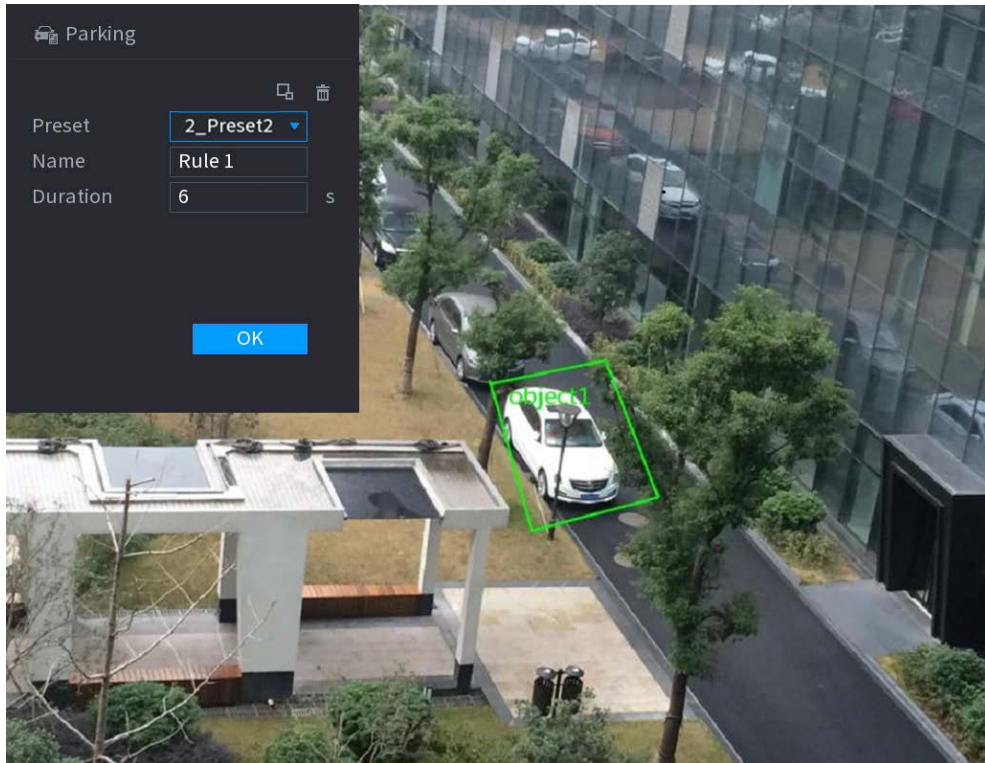

Parameter	Description
Preset	Set the preset point for IVS detection.
Name	Customize the rule name.
Duration	Set how long the object stays until the alarm is triggered.

- 4) Click **OK**.

Step 6 Configure alarm schedule and linkage.

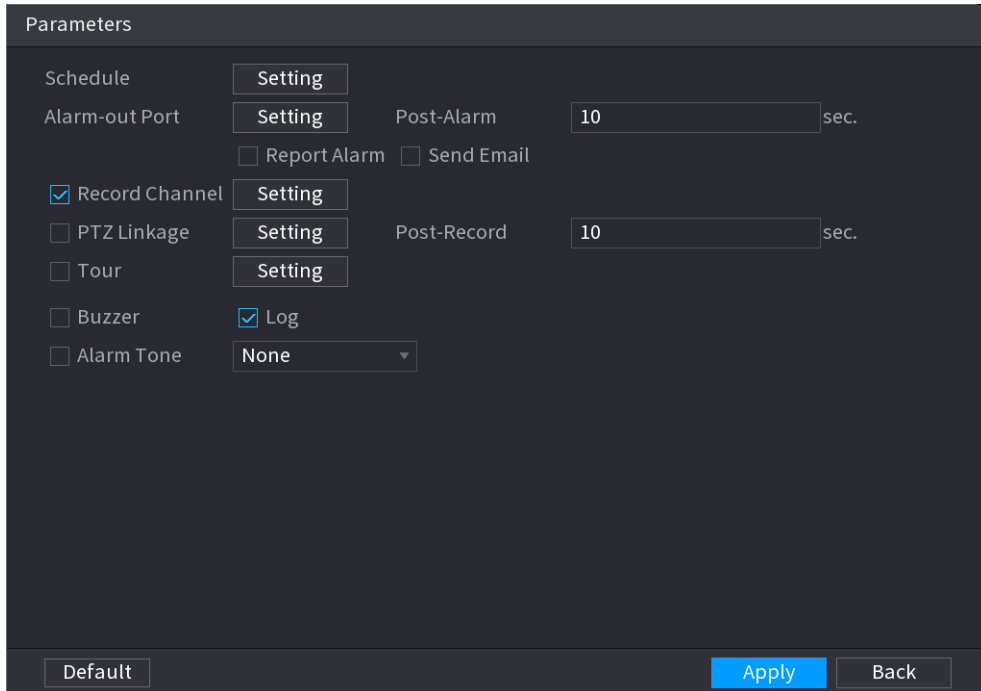
Figure 5-122 Schedule and alarm linkage



- 1) Click .
- 2) Click **Setting** next to **Schedule** to configure the alarm period.
The system performs linkage actions only for alarms during the arming period.
 - On the time line, drag to set the period.
 - You can also click  to set the period.
- 3) Configure alarm linkage. For details, see Table 5-43.
- 4) Click **Apply**.

Step 7 Select **Enable** checkbox and then click **Apply**.

5.9.6.2.6 Crowd Gathering

Background Information

The system generates an alarm once people are gathering in the specified zone longer than the defined duration.

Procedure

Step 1 Select **Main Menu > AI > Parameters > IVS**.

Figure 5-123 IVS

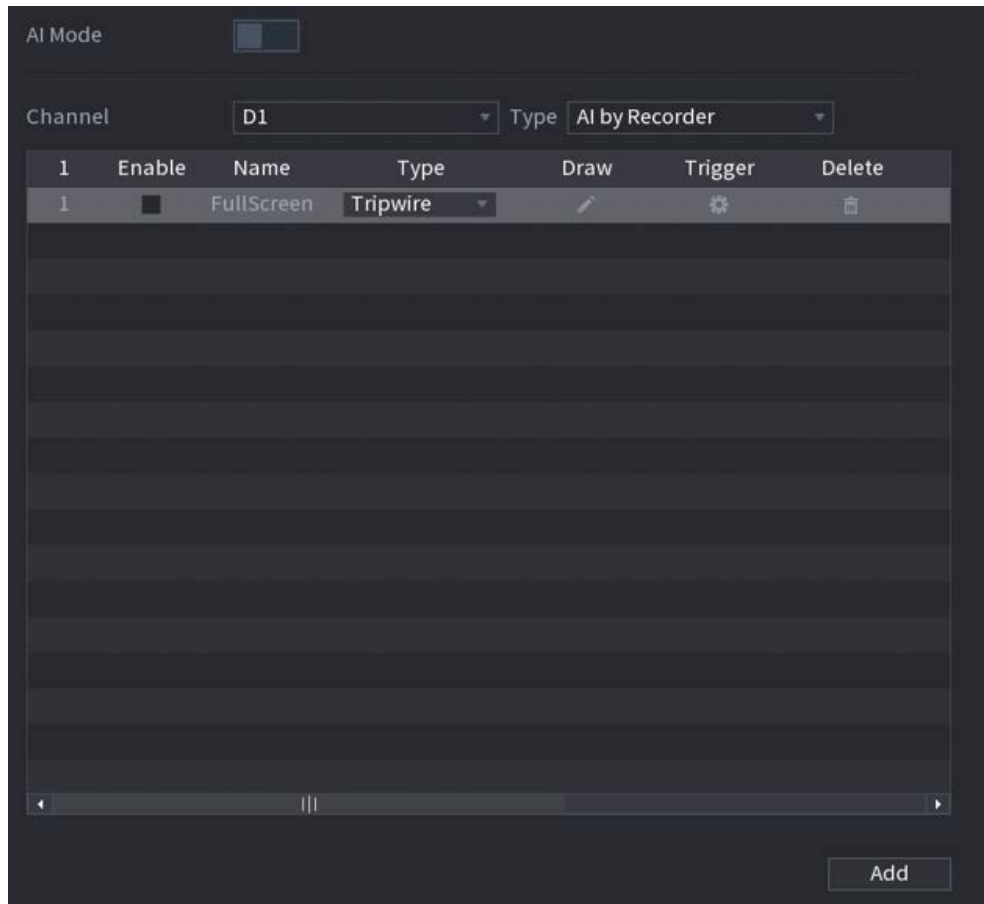

Step 2 Select channel and AI type.

Step 3 Click **Add** to add a rule.

Step 4 On the **Type** list, select **Crowd Gathering Estimation**.

Step 5 Draw the detection rule.



- 1) Click  to draw a rectangle on the surveillance video image. Right-click the image to stop drawing.

Figure 5-124 Crowd gathering

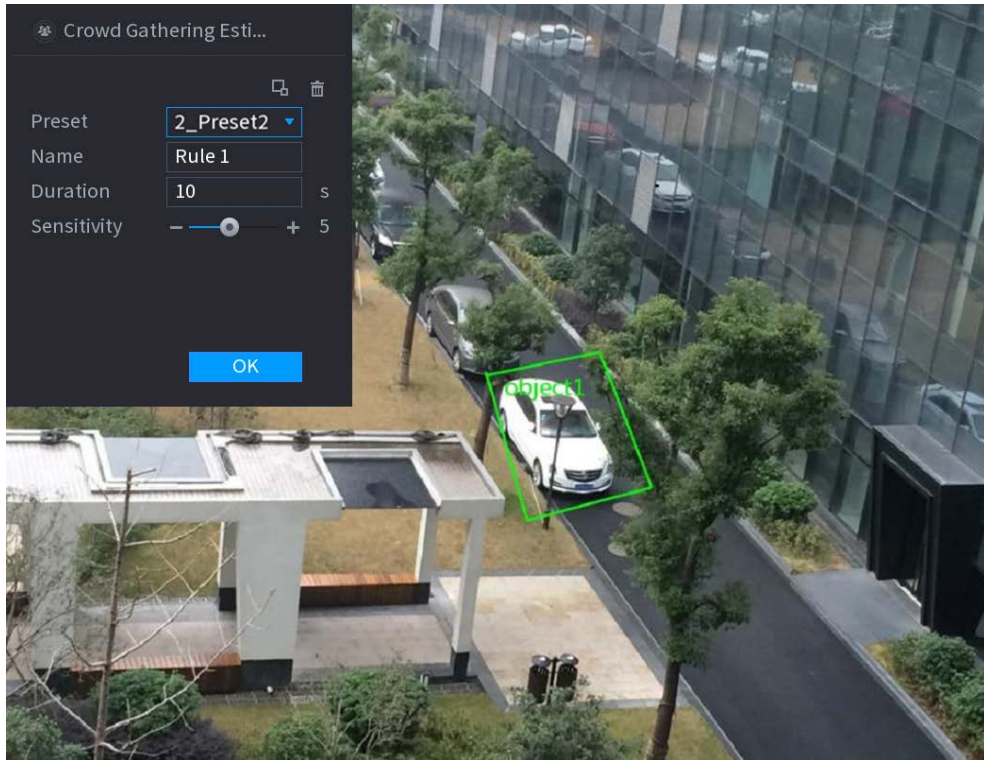

2) Click  to draw the minimum size or maximum size to filter the target.

The system triggers an alarm only when the size of detected target is between the maximum size and the minimum size.

3) Set parameters.

Table 5-33 Crowd gathering parameters



Parameter	Description
Preset	Select a preset you want to use IVS.
Name	Customize the rule name.
Duration	Set how long the object stays until the alarm is triggered.
Sensitivity	You can set alarm sensitivity. The higher the value, the easier to detect crowd gathering but meanwhile the higher false alarm rate.

4) Click **OK**.

Step 6 Configure alarm schedule and linkage.

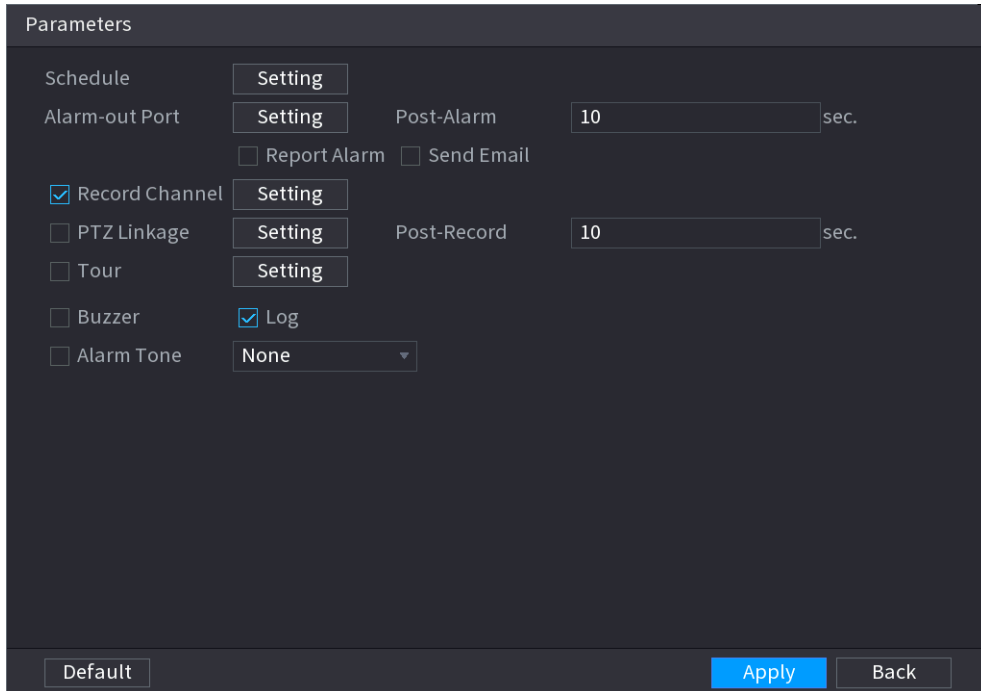
Figure 5-125 Schedule and alarm linkage



- 1) Click .
- 2) Click **Setting** next to **Schedule** to configure the alarm period.
 - The system performs linkage actions only for alarms during the arming period.
 - On the time line, drag to set the period.
 - You can also click  to set the period.
- 3) Configure alarm linkage. For details, see Table 5-43.
- 4) Click **Apply**.

Step 7 Select **Enable** checkbox and then click **Apply**.

5.9.6.2.7 Missing Object Detection

Background Information

The system generates an alarm when there is missing object in the specified zone.

Procedure

Step 1 Select **Main Menu > AI > Parameters > IVS**.

Figure 5-126 IVS

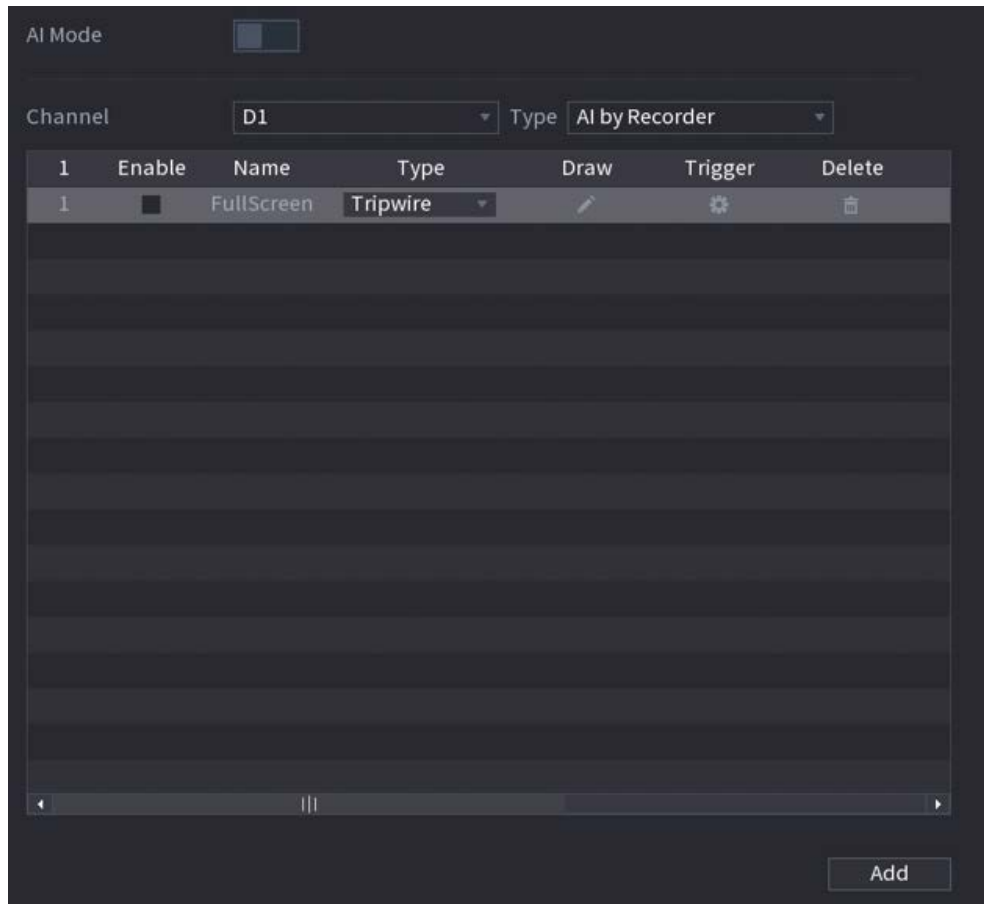

Step 2 Select channel and AI type.

Step 3 Click **Add** to add a rule.

Step 4 On the **Type** list, select **Missing**.

Step 5 Draw the detection rule.



- 1) Click  to draw a rectangle on the surveillance video image. Right-click the image to stop drawing.

Figure 5-127 Missing object

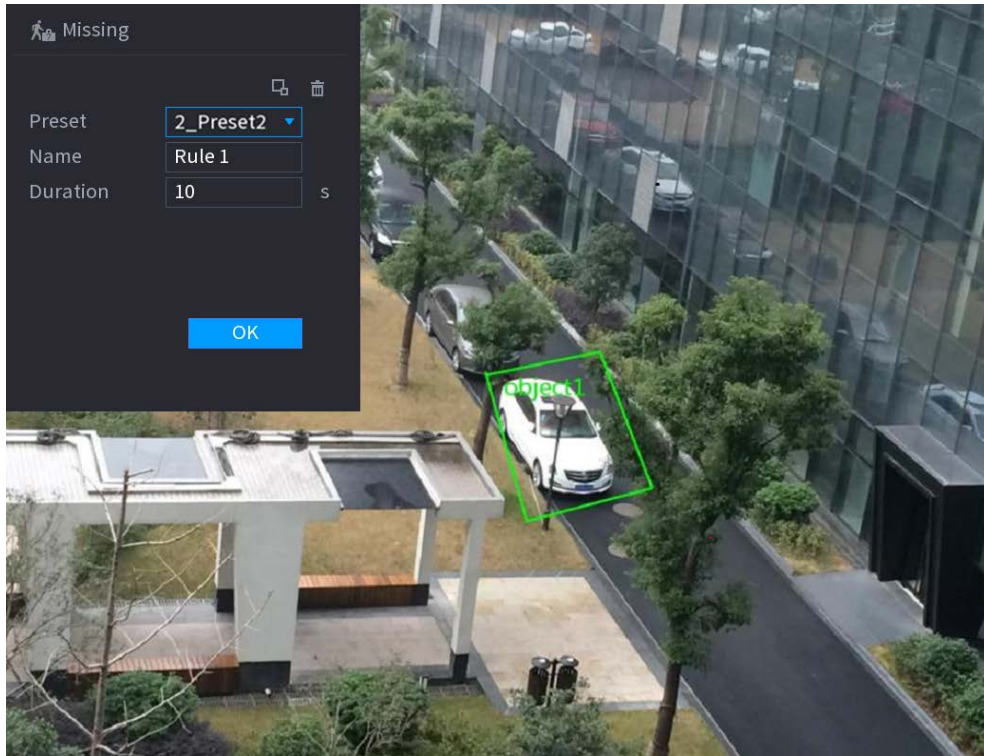

2) Click  to draw the minimum size or maximum size to filter the target.

The system triggers an alarm only when the size of detected target is between the maximum size and the minimum size.

3) Configure parameters.

Table 5-34 Parameters of missing object detection



Parameter	Description
Preset	Set the preset point for IVS detection according to the actual needs.
Name	Customize the rule name.
Duration	Set how long the object stays until the alarm is triggered.

4) Click **OK**.

Step 6 Configure alarm schedule and linkage.

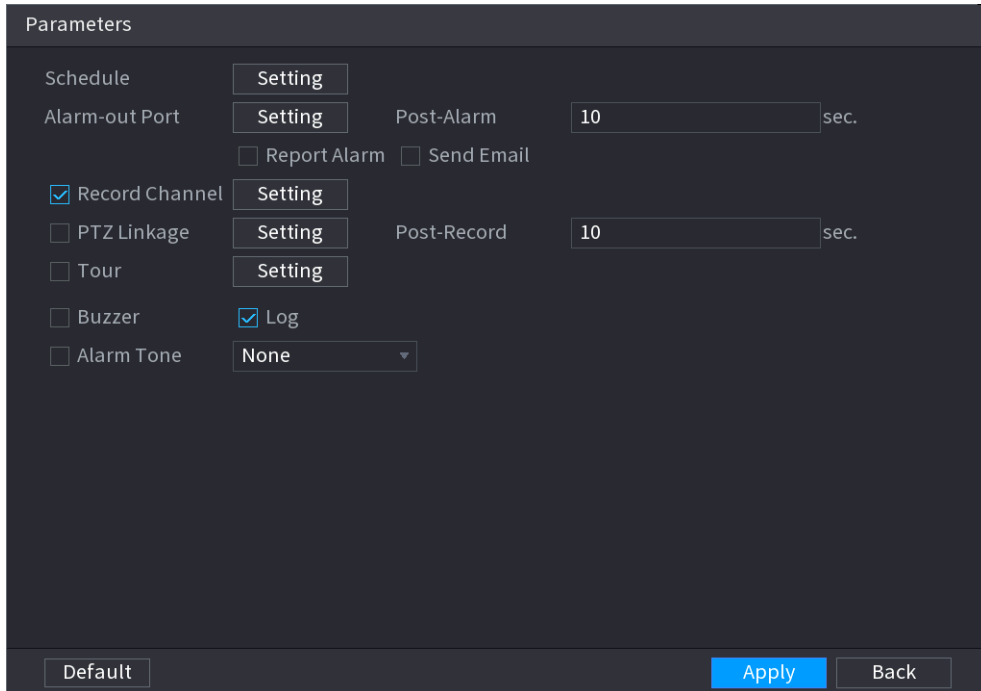
Figure 5-128 Schedule and alarm linkage



- 1) Click .
- 2) Click **Setting** next to **Schedule** to configure the alarm period.
The system performs linkage actions only for alarms during the arming period.
 - On the time line, drag to set the period.
 - You can also click  to set the period.
- 3) Configure alarm linkage. For details, see Table 5-43.
- 4) Click **Apply**.

Step 7 Select **Enable** checkbox and then click **Apply**.

5.9.6.2.8 Loitering Detection

Background Information

The system generates an alarm once the object is staying in the specified zone longer than the defined duration.

Procedure

Step 1 Select **Main Menu > AI > Parameters > IVS**.

Figure 5-129 IVS

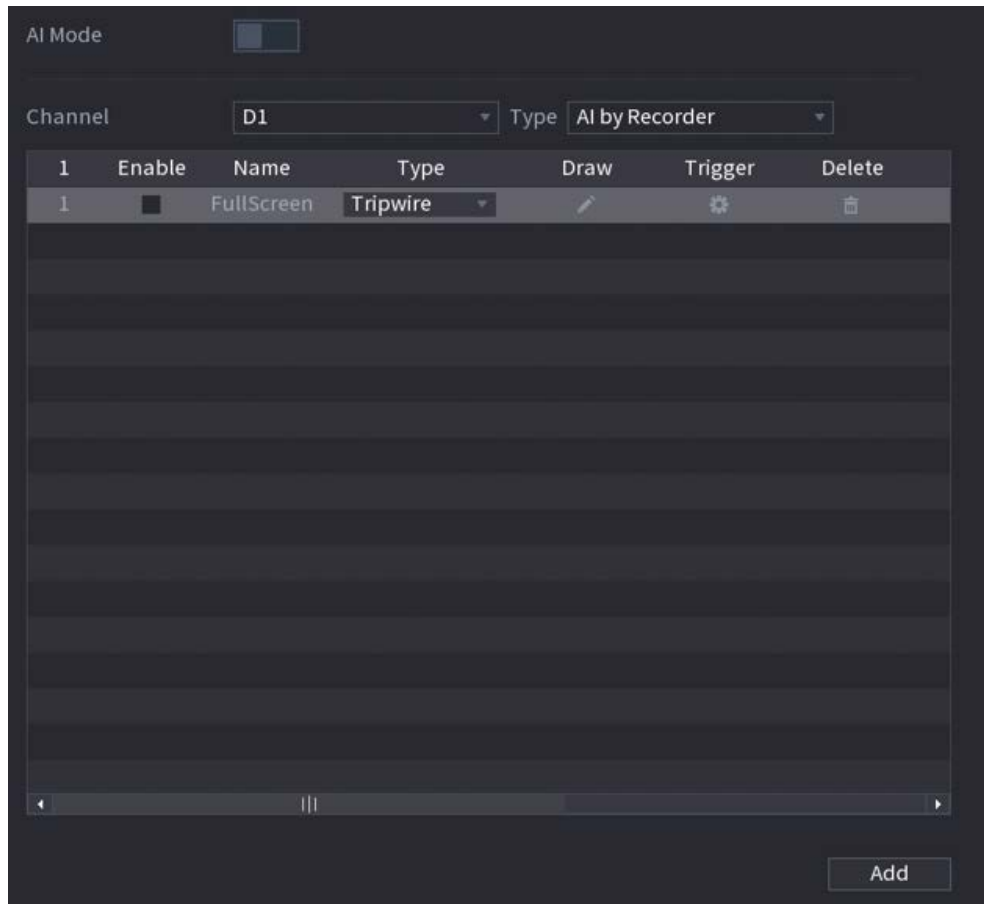

Step 2 Select channel and AI type.

Step 3 Click **Add** to add a rule.

Step 4 On the **Type** list, select **Loitering Detection**.

Step 5 Draw the detection rule.

- 1) Click  to draw a rectangle on the surveillance video image. Right-click the image to stop drawing.

Figure 5-130 Loitering detection



- 2) Click  to draw the minimum size or maximum size to filter the target.
The system triggers an alarm only when the size of detected target is between the maximum size and the minimum size.
- 3) Configure parameters.

Table 5-35 Loitering detection parameters

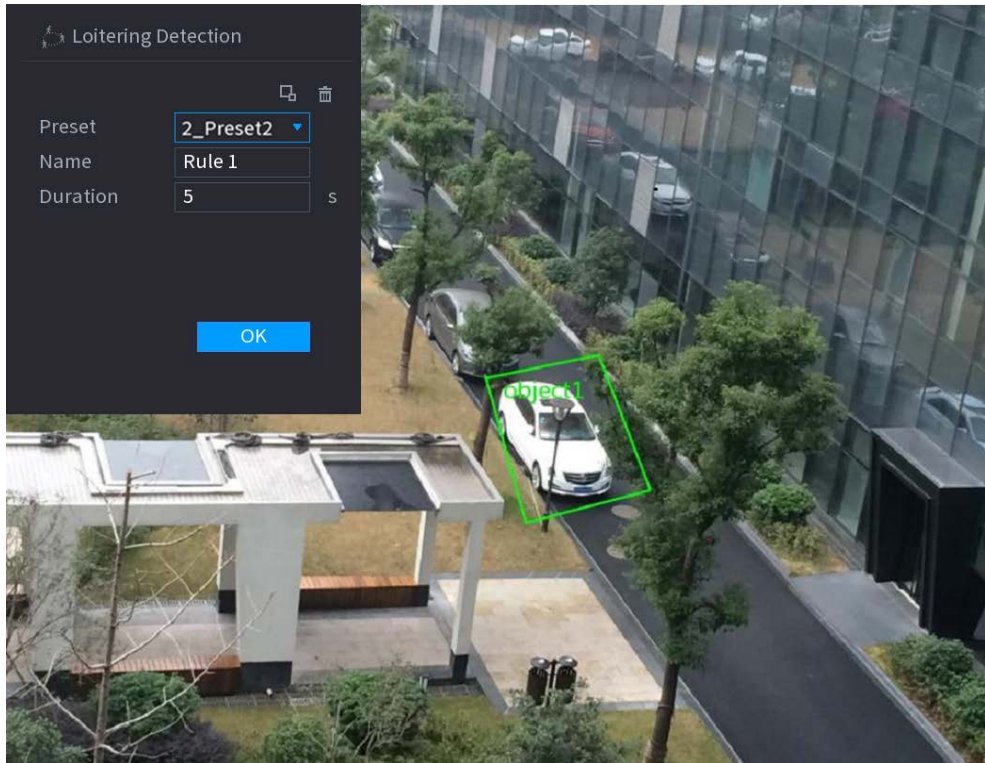

Parameter	Description
Preset	Set the preset point for IVS detection.
Name	Customize the rule name.
Duration	Set how long the object stays until the alarm is triggered.

- 4) Click **OK**.

Step 6 Configure alarm schedule and linkage.

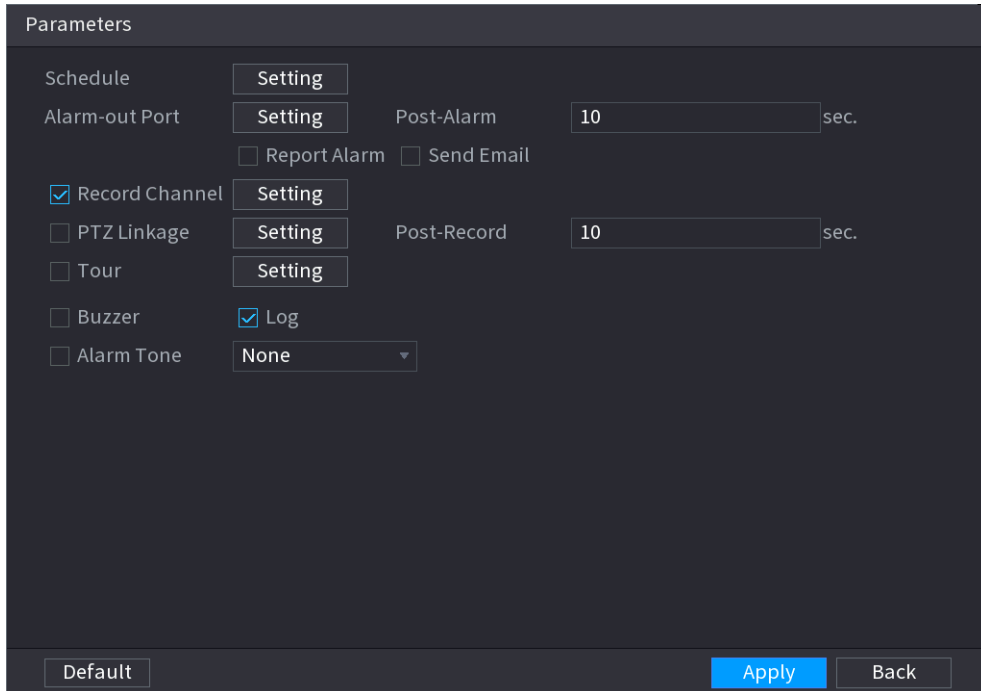
Figure 5-131 Schedule and alarm linkage



- 1) Click .
- 2) Click **Setting** next to **Schedule** to configure the alarm period.
 - The system performs linkage actions only for alarms during the arming period.
 - On the time line, drag to set the period.
 - You can also click  to set the period.
- 3) Configure alarm linkage. For details, see Table 5-43.
- 4) Click **Apply**.

Step 7 Select **Enable** checkbox and then click **Apply**.

5.9.6.3 AI Search (IVS)

Background Information

You can search for IVS detection results.

Procedure

Step 1 Select **Main Menu > AI > AI Search > IVS**.

Figure 5-132 IVS search

- Step 2** Select a channel, start time, end time, event type, and then click **Search**.
The search results are displayed.

Related Operations

- Play back video.
Click an image, and then click to play back the related video.
During playback, you can:
 - ◇ Click to pause.
 - ◇ Click to stop.
 - ◇ Click to display AI rule. The icon changes to .
- Add tags.
Select one or more images, and then click **Add Tag**.
- Lock.
Select one or more images, and then click **Lock**. The locked files will not be overwritten.
- Export.
Select one or more images, and then click **Export** to export selected search results in excel.
- Back up.
Select one or more images, click **Backup**, select the storage path and file type, and then click **Start** to export files to external storage device.

5.9.7 Stereo Analysis

By drawing and setting the rules of stereo behavior analysis, the system will perform alarm linkage actions when the video matches the detection rule. Types of events include: people approach detection, fall detection, violence detection, people No. exception detection and people stay detection.



- This function requires access to a camera that supports stereo behavior analysis.
- Stereo analysis and IVS are mutually exclusive and cannot be enabled at the same time.

5.9.7.1 Enabling Smart Plan

To use AI by camera, you need to enable the smart plan first. For details, see "5.9.2 Smart Plan".

5.9.7.2 Configuring Stereo Analysis

5.9.7.2.1 People Approach Detection

When two people stay in the same detection area longer than the defined duration or when the distance between two people is larger or smaller than the defined threshold, an alarm will be triggered.

Procedure

Step 1 Select **Main Menu > AI > Parameters > Stereo Analysis**.

Step 2 Select a channel and then click **Add**.

Step 3 Select **Enable** and then set **Type** to **People Approach Detection**.

Step 4 Draw detection rule.

- 1) Click , and then draw a detection area on the video image. Right-click the image to stop drawing.
- 2) Configure parameters.



Table 5-36 Parameters of people approach detection

Parameter	Description
Name	Customize the rule name.
Sensitivity	Set alarm sensitivity.
Duration	Set how long two people stay in the same detection area until an alarm is triggered.
Repeat Alarm Time	Set repeat alarm time. If the alarm-triggering event continues, an alarm will be triggered again when repeat alarm time passed.
Interval Threshold	When the distance between people in the area is greater than or less than the defined threshold, an alarm will be triggered.

- 3) Click **OK**.

Step 5 Configure alarm schedule and linkage.

Figure 5-133 Schedule and alarm linkage

- 1) Click .
- 2) Click **Setting** next to **Schedule** to configure the alarm period.
The system performs linkage actions only for alarms during the arming period.
 - On the time line, drag to set the period.
 - You can also click  to set the period.
- 3) Configure alarm linkage. For details, see Table 5-43.
- 4) Click **Apply**.

Step 6 Click **Apply**.

5.9.7.2.2 Fall Detection

When someone falls from a height in the detection area and the duration of the action is greater than the defined threshold, an alarm will be triggered.

Procedure

- Step 1 Select **Main Menu > AI > Parameters > Stereo Analysis**.
- Step 2 Select a channel and then click **Add**.
- Step 3 Select **Enable** and then set **Type** to **Fall Detection**.
- Step 4 Draw detection rule.
 - 1) Click , and then draw a detection area on the video image. Right-click the image to stop drawing.
 - 2) Configure parameters.

Table 5-37 Parameters of fall detection

Parameter	Description
Name	Customize the rule name.
Sensitivity	Set alarm sensitivity.

Parameter	Description
Duration	Set the minimum time of triggering an alarm when people fall.
Repeat Alarm Time	Set repeat alarm time. If the alarm-triggering event continues, an alarm will be triggered again when repeat alarm time passed.

3) Click **OK**.

Step 5 Configure alarm schedule and linkage.

Figure 5-134 Schedule and alarm linkage

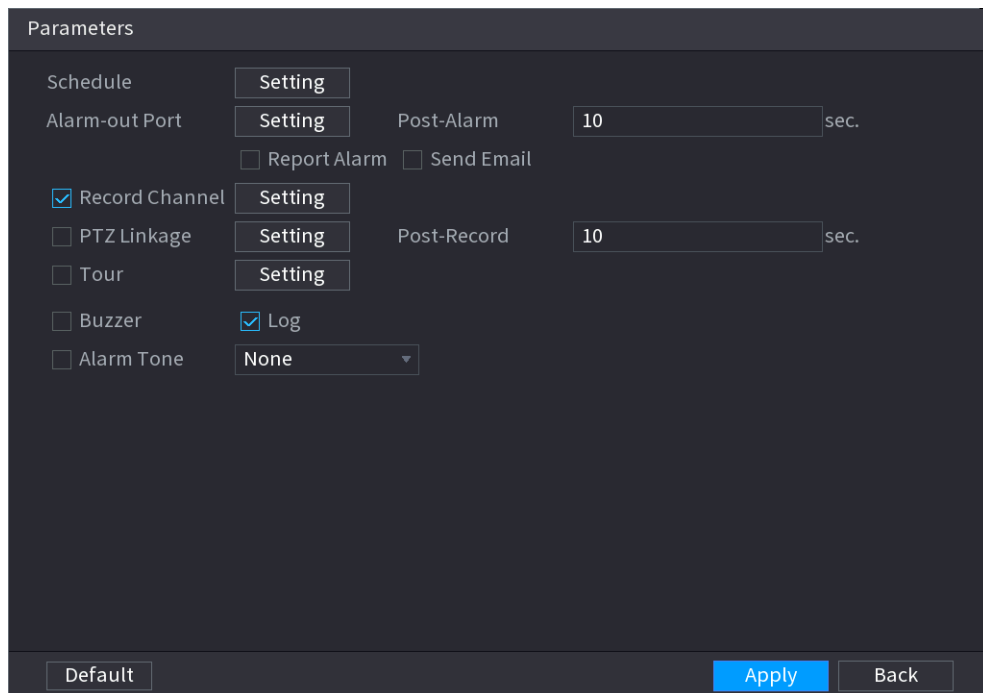

1) Click .

2) Click **Setting** next to **Schedule** to configure the alarm period.

The system performs linkage actions only for alarms during the arming period.

- On the time line, drag to set the period.
- You can also click  to set the period.

3) Configure alarm linkage. For details, see Table 5-43.

4) Click **Apply**.

Step 6 Click **Apply**.

5.9.7.2.3 Violence Detection

When the target in the detection region has large body movements such as smashing and fighting, an alarm will be triggered.

Procedure

Step 1 Select **Main Menu > AI > Parameters > Stereo Analysis**.

Step 2 Select a channel and then click **Add**.

Step 3 Select **Enable** and then set **Type** to **Violence Detection**.

Step 4 Draw detection rule.

1) Click , and then draw a detection area on the video image. Right-click the image to

- stop drawing.
- 2) Configure parameters.



Table 5-38 Parameters of violence detection

Parameter	Description
Name	Customize the rule name.
Sensitivity	Set alarm sensitivity.

- 3) Click **OK**.

Step 5 Configure alarm schedule and linkage.

Figure 5-135 Schedule and alarm linkage

- 1) Click .
- 2) Click **Setting** next to **Schedule** to configure the alarm period.
The system performs linkage actions only for alarms during the arming period.
 - On the time line, drag to set the period.
 - You can also click  to set the period.
- 3) Configure alarm linkage. For details, see Table 5-43.
- 4) Click **Apply**.

Step 6 Click **Apply**.

5.9.7.2.4 People No. Exception Detection

When the system detects an abnormal number of people in the same detection area, an alarm will be triggered.

Procedure

- Step 1** Select **Main Menu > AI > Parameters > Stereo Analysis**.
- Step 2** Select a channel and then click **Add**.
- Step 3** Select **Enable** and then set **Type** to **People No. Exception Detection**.

- Step 4** Draw detection rule.
- 1) Click , and then draw a detection area on the video image. Right-click the image to stop drawing.
 - 2) Configure parameters.



Table 5-39 Parameters of people No. exception detection

Parameter	Description
Name	Customize the rule name.
Sensitivity	Set alarm sensitivity.
Duration	Set the minimum time to trigger an alarm after the system detects an abnormal number of people.
Repeat Alarm Time	Set repeat alarm time. If the alarm-triggering event continues, an alarm will be triggered again when repeat alarm time passed.
Alarm People No.	When the number of people in the area is greater than, equal to, or less than the defined threshold, an alarm will be triggered.

- 3) Click **OK**.

- Step 5** Configure alarm schedule and linkage.

Figure 5-136 Schedule and alarm linkage

- 1) Click .
- 2) Click **Setting** next to **Schedule** to configure the alarm period.
 - The system performs linkage actions only for alarms during the arming period.
 - On the time line, drag to set the period.
 - You can also click  to set the period.
- 3) Configure alarm linkage. For details, see Table 5-43.
- 4) Click **Apply**.

- Step 6** Click **Apply**.

5.9.7.2.5 People Stay Detection

When the target stays in the detection area longer than the defined duration, an alarm will be triggered.

Procedure

- Step 1 Select **Main Menu > AI > Parameters > Stereo Analysis**.
- Step 2 Select a channel and then click **Add**.
- Step 3 Select **Enable** and then set **Type** to **People Stay Detection**.
- Step 4 Draw detection rule.
 - 1) Click , and then draw a detection area on the video image. Right-click the image to stop drawing.
 - 2) Configure parameters.

Table 5-40 Parameters of people stay detection

Parameter	Description
Name	Customize the rule name.
Sensitivity	Set alarm sensitivity.
Duration	Set low long people stay in the detection area until an alarm is triggered.
Repeat Alarm Time	Set repeat alarm time. If the alarm-triggering event continues, an alarm will be triggered again when repeat alarm time passed.

- 3) Click **OK**.

- Step 5 Configure alarm schedule and linkage.

Figure 5-137 Schedule and alarm linkage

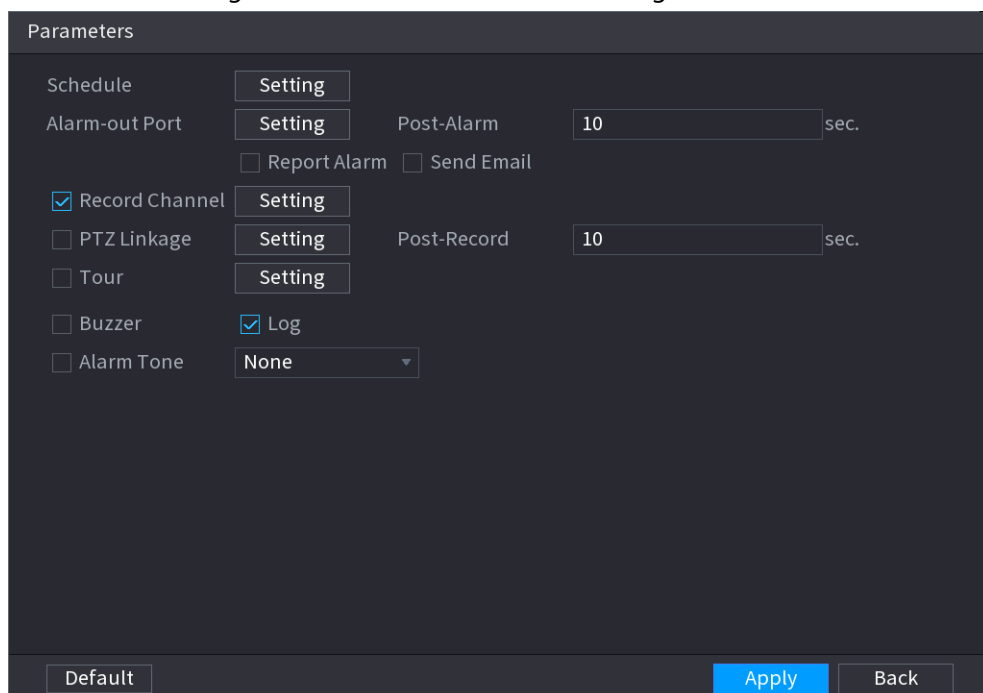

- 1) Click .
- 2) Click **Setting** next to **Schedule** to configure the alarm period.
The system performs linkage actions only for alarms during the arming period.

- On the time line, drag to set the period.
 - You can also click  to set the period.
- 3) Configure alarm linkage. For details, see Table 5-43.
- 4) Click **Apply**.

Step 6 Click **Apply**.

5.9.7.3 AI Search (Stereo Analysis)

Background Information

You can search for detection results of stereo analysis.

Procedure



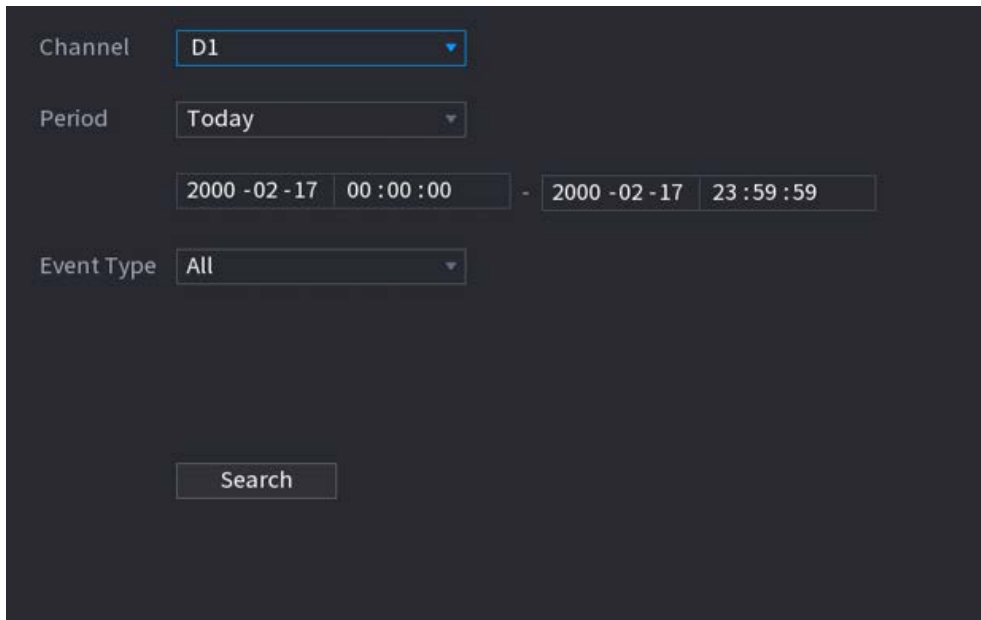

Step 1 Select **Main Menu > AI > AI Search > Stereo Analysis**.

Figure 5-138 Stereo analysis search



Step 2 Select a channel, start time, end time, event type, and then click **Search**.
The search results are displayed.

Related Operations

- Play back video.
Click an image, and then click  to play back the related video.
During playback, you can:
 - ◇ Click  to pause.
 - ◇ Click  to stop.
 - ◇ Click  to display AI rule. The icon changes to .
- Add tags.
Select one or more images, and then click **Add Tag**.
- Lock.
Select one or more images, and then click **Lock**. The locked files will not be overwritten.
- Export.
Select one or more images, and then click **Export** to export selected search results in excel.

- Back up.
Select one or more images, click **Backup**, select the storage path and file type, and then click **Start** to export files to external storage device.

5.9.8 Video Metadata

The system analyzes real-time video stream to detect the existence of human, motor vehicle, and non-motor vehicle. Once a target is detected, an alarm is triggered.

5.9.8.1 Enabling Smart Plan

To use AI by camera, you need to enable the smart plan first. For details, see "5.9.2 Smart Plan".

5.9.8.2 Configuring Video Metadata

When a metadata alarm is triggered, the system links the corresponding camera to record videos and logs and take snapshots. Other alarm linkage actions are not supported for video metadata.

Procedure

Step 1 Select **Main Menu > AI > Parameters > Video Metadata**.

Figure 5-139 Video metadata

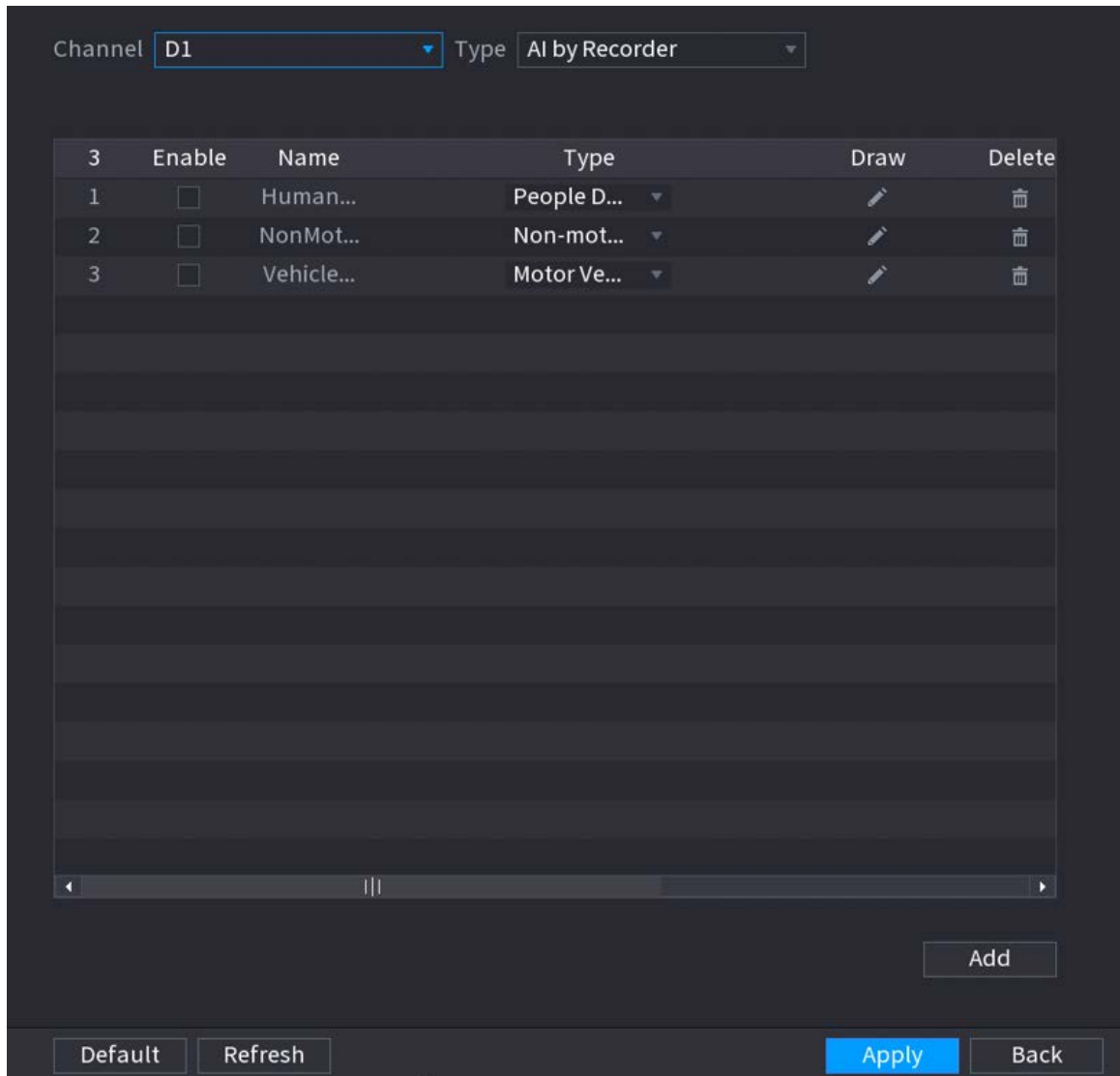

Step 2 Select a channel and AI type.



AI by Recorder is available on select models.

Step 3 Click **Add** to add a rule.



Step 4 Select **Enable** and then set **Type** to **People Detection**, **Non-motor Vehicle Detection** or **Motor Vehicle Detection**.

Step 5 Draw detection rule.

- 1) Click and then draw a detection area on the video image. Right-click the image to stop drawing.

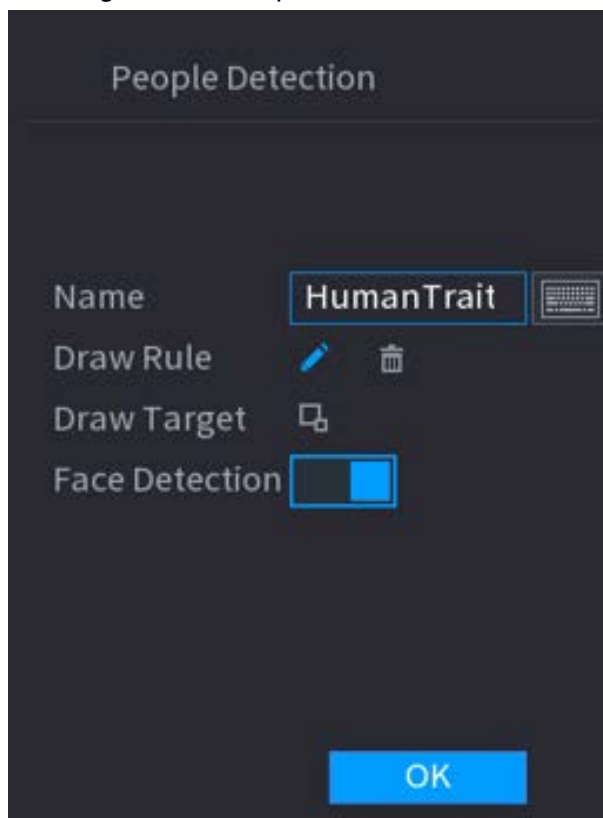
Figure 5-140 People detection



- 2) Enter the rule name.
- 3) Click  to draw the minimum size or maximum size to filter the target.
The system triggers an alarm only when the size of detected target is between the maximum size and the minimum size.
- 4) Click  to enable face detection.
- 5) Select **A to B**, **B to A**, or **Both** as direction for tripwire counting.



Tripwire counting is available when AI by Camera is used and the camera supports this function.

- 6) Click **OK**.

Step 6 Click **Apply**.

5.9.8.3 AI Search (Video Metadata)

You can search for the video metadata detection results and play back related videos.

5.9.8.3.1 Human Detection

Procedure

Step 1 Select **Main Menu > AI > AI Search > Human Detection**.

Figure 5-141 Human detection

Step 2 Select a channel, start time, end time, and set corresponding parameters.

Step 3 Click **Search**.



For privacy protection, the faces are intentionally blurred.

Figure 5-142 Search results

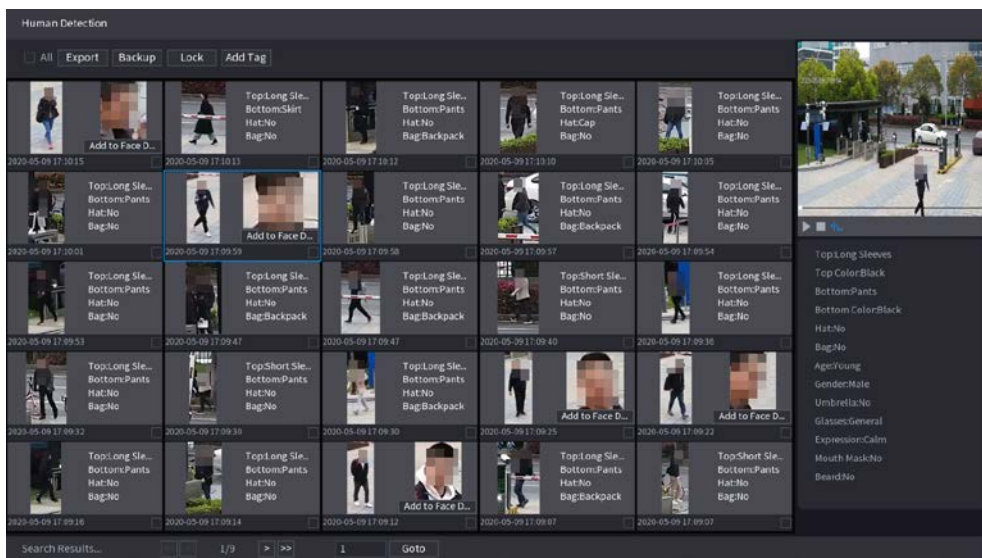





Related Operations

- Play back video.

Click an image, and then click  to play back the related video.

During playback, you can:

- ◇ Click  to pause.
- ◇ Click  to stop.
- ◇ Click  to display AI rule. The icon changes to .

- Add tags.

Select one or more images, and then click **Add Tag**.

- Lock.

Select one or more images, and then click **Lock**. The locked files will not be overwritten.

- Export.

Select one or more images, and then click **Export** to export selected search results in excel.

- Back up.

Select one or more images, click **Backup**, select the storage path and file type, and then click **Start** to export files to external storage device.

5.9.8.3.2 Motor Vehicle Detection

Background Information

You can search for motor vehicle detection results according to the vehicle parameters.



This function is available on select models.

Procedure

Step 1 Select **Main Menu > AI > AI Search > Motor Vehicle Detection**.

Figure 5-143 Motor vehicle detection

Step 2 Select a channel and then set parameters.







- The system supports fuzzy search of plate numbers.
- The system searches all plate numbers by default if you have not set a plate number.

Step 3 Click **Search**.

The search results are displayed.

Related Operations

- Play back video.
Click an image, and then click  to play back the related video.
During playback, you can:
 - ◇ Click  to pause.
 - ◇ Click  to stop.
 - ◇ Click  to display AI rule. The icon changes to .
- Add tags.
Select one or more images, and then click **Add Tag**.
- Lock.
Select one or more images, and then click **Lock**. The locked files will not be overwritten.
- Export.
Select one or more images, and then click **Export** to export selected search results in excel.
- Back up.
Select one or more images, click **Backup**, select the storage path and file type, and then click

Start to export files to external storage device.

5.9.8.3.3 Non-motor Vehicle Detection

Background Information

You can search for non-motor vehicle detection results according to the non-motor vehicle parameters.



This function is available on select models.

Procedure

Step 1 Select **Main Menu > AI > AI Search > Non-Motor Vehicle Detection** .

Figure 5-144 Non-motor vehicle detection

Channel	D1
Period	Today
	2000 -02 -17 00 :00 :00 - 2000 -02 -17 23 :59 :59
Type	All
Color	All
Number of Passengers	All
Hat	All
	Search

Step 2 Select a channel and then set parameters.

Step 3 Click **Search**.

Figure 5-145 Search results

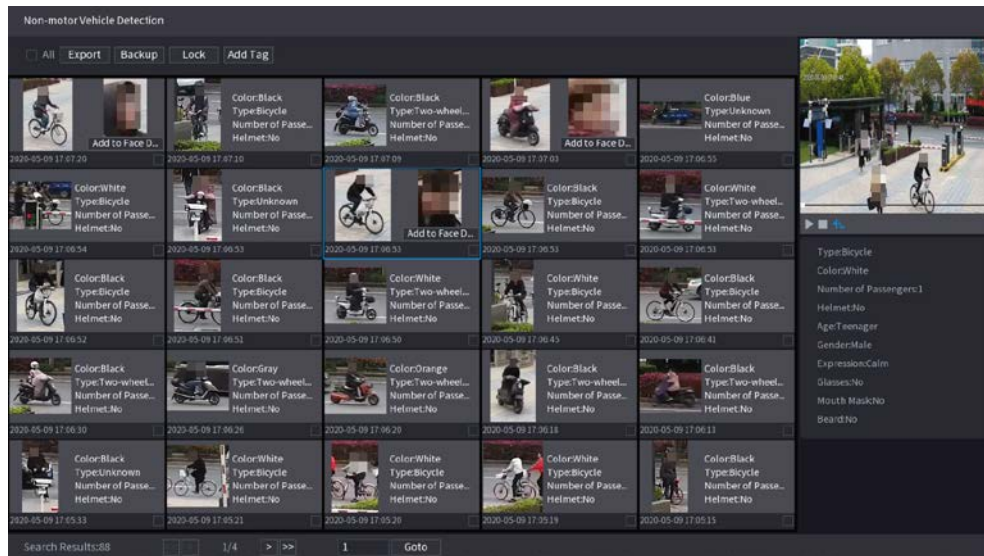

Related Operations

- Play back video.
Click an image, and then click to play back the related video.
During playback, you can:
 - ◇ Click to pause.
 - ◇ Click to stop.
 - ◇ Click to display AI rule. The icon changes to .
- Add tags.
Select one or more images, and then click **Add Tag**.
- Lock.
Select one or more images, and then click **Lock**. The locked files will not be overwritten.
- Export.
Select one or more images, and then click **Export** to export selected search results in excel.
- Back up.
Select one or more images, click **Backup**, select the storage path and file type, and then click **Start** to export files to external storage device.

5.9.8.3.4 Report Query

Background Information

You can search for and export video metadata statistics.



- The statistics might be overwritten when the storage space runs out. Back up in time.
- When you restore the Device to factory settings, all the data except data in the external storage device will be cleared. You can clear the data in the external storage device through formatting or other methods.

Procedure

Step 1 Select **Main Menu > AI > Report Query > Video Metadata**.

Figure 5-146 Metadata statistics

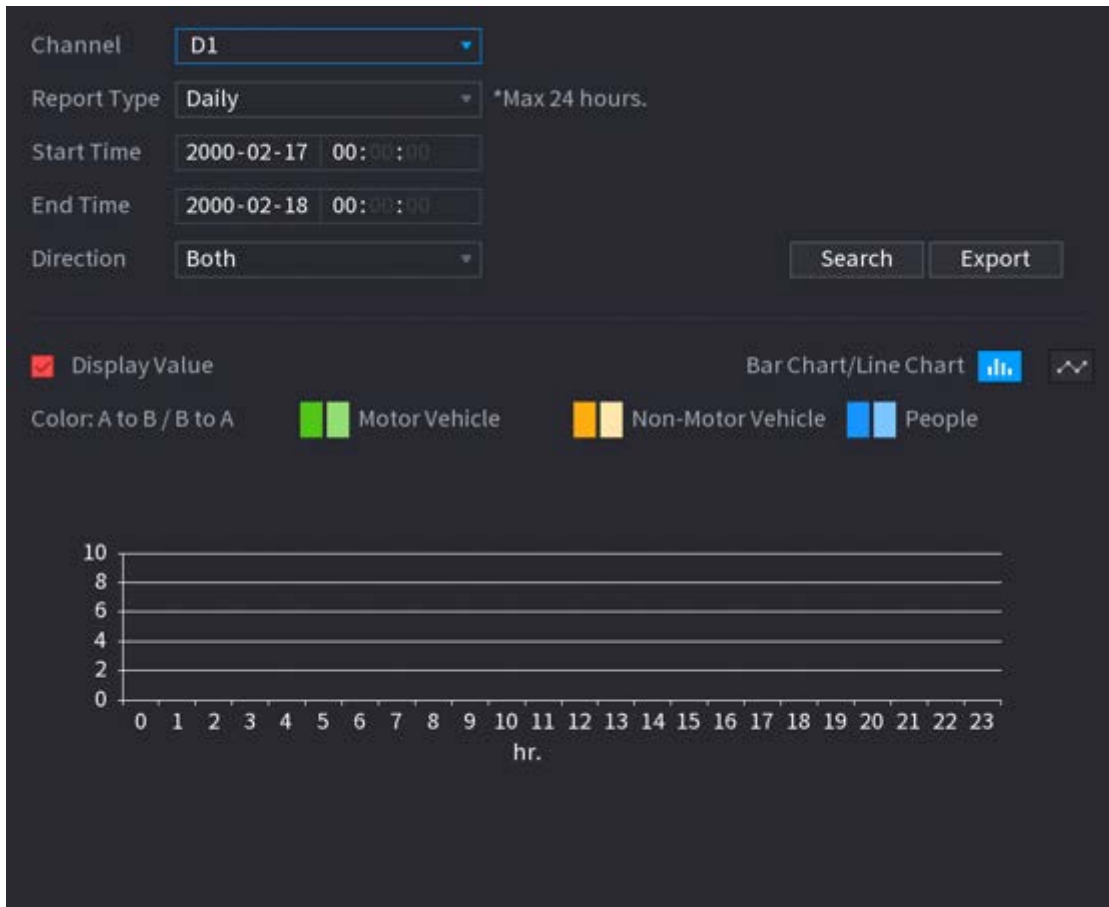

Step 2 Select channel, report type, start time and end time, direction and then click **Search**.

Related Operations

- Switch chart type.
Click **Bar Chart** or **Line Chart** to switch the chart type.
- Export.
Select file type, and then click **Export** to export the report in picture or csv format.

5.9.9 ANPR

The system extracts the plate number on the surveillance video and then compare it with the specified plate information. When a match is detected, the system triggers an alarm.

5.9.9.1 Adding Vehicle Blocklist and Allowlist

Background Information

To facilitate vehicle management, you can add the plate numbers to the blocklist or allowlist. The system can compare the detected plate information with the plate on the blocklist and allowlist and then trigger the corresponding alarm linkage.

- With the blocklist and allowlist enabled, on the live page, the plate on the blocklist is displayed as red on the plate list and the plate on the allowlist is displayed as green. For the plate not on the blocklist or allowlist, the color is white.

- The added blacklist and allowlist will be synchronized to the connected ITC camera.

Procedure

Step 1 Select **Main Menu > AI > Database > Vehicle Blocklist/Allowlist.**

Figure 5-147 Vehicle blocklist/allowlist

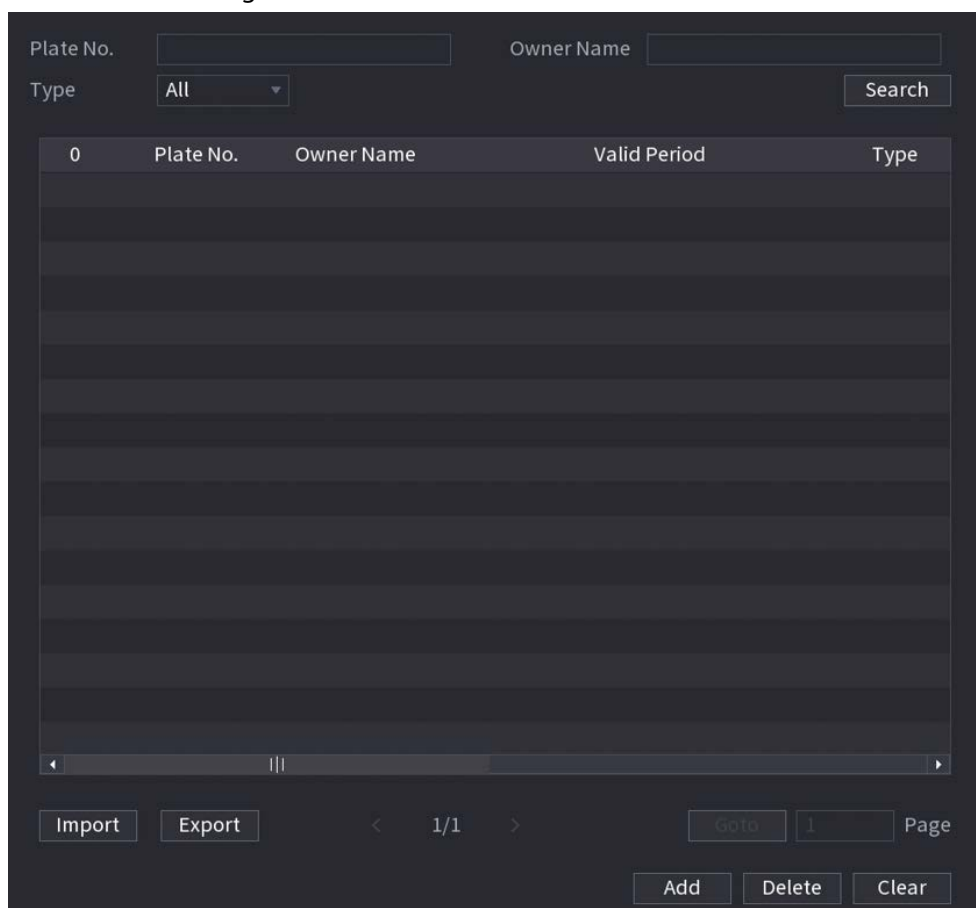

Step 2 Click **Add.**

Step 3 Set plate information such as plate number, car owner name, select **Block List** or **Allow List**, and then set validity period.

Step 4 Click **OK.**

Related Operations

- Search.
Enter keywords for **Plate No.** and **Owner Name**, select type and then click **Search.**
- Import and export plate information.
 - ◇ Import: Click **Import**, select the corresponding file, and then click **Browse** to import the file.
 - ◇ Export: Click **Export**, select the file storage path and then click **Save.**
- Delete plate information.
 - ◇ Delete one by one: Click the  of the corresponding plate number.
 - ◇ Delete in batches: Select the plate numbers and then click **Delete.**

5.9.9.2 Configuring ANPR

Background Information

Configure the ANPR alarm rules.

Procedure

Step 1 Select **Main Menu > AI > Parameters > ANPR**.

Figure 5-148 ANPR

Step 2 Select a channel and then select the **Enable** checkbox to enable ANPR.

Step 3 (Optional) Enable **Sync Vehicle Blocklist/Allowlist** to synchronize the blocklist and allowlist on the NVR to the connected camera.

Step 4 Click **General** (default), **Blocklist** or **Allowlist** tab.



Before enabling the blocklist alarm or allowlist alarm, you need to add the corresponding plate information.

- **General:** The system triggers an alarm when it detects any plate number.
- **Block List:** The system triggers an alarm when it detects plate number on the blocklist.
- **Allow List:** The system triggers an alarm when it detects plate number on the allowlist.

Step 5 Click **Setting** next to **Schedule** to configure the arming period.

The system triggers corresponding alarm actions only during the arming period.

- On the time line, drag to set the period.
- You can also click  to set the period.

Step 6 Configure alarm linkage actions. For details, see Step 7.

Step 7 Click **Apply**.

5.9.9.3 AI Search (ANPR)

You can search for the ANPR detection results. For details, see "5.9.8.3.2 Motor Vehicle Detection".

5.9.10 Crowd Distribution

The system detects the crowd distribution. When the crowd density exceeds the defined threshold, an alarm is triggered.

5.9.10.1 Enabling Smart Plan

To use AI by camera, you need to enable the smart plan first. For details, see "5.9.2 Smart Plan".

5.9.10.2 Configuring Crowd Distribution

Configure the alarm rules of crowd distribution detection.

Prerequisites

Make sure that the connected camera supports the crowd distribution function.

Background Information

Procedure

Step 1 Select **Main Menu > AI > Parameters > Crowd Distribution**.

Figure 5-149 Crowd distribution

Step 2 Select a channel and then click  next to **Enable**.

Step 3 Configure parameters.

Table 5-41 Crowd distribution parameters

Parameter	Description
Crowd Density (Global)	Click  and then configure the density threshold.
Crowd Density	
Alarm Tracking	After an alarm occurs, the system tracks the target automatically.

Step 4 Click **Setting** next to **Schedule** to configure the arming period.
The system triggers corresponding alarm actions only during the arming period.

- On the time line, drag to set the period.
- You can also click  to set the period.

Step 5 Configure alarm linkage actions. For details, see [Step7](#).

Step 6 Click **Apply**.

5.9.10.3 Report Query

Background Information

You can search for and export video metadata statistics.



- The statistics might be overwritten when the storage space runs out. Back up in time.
- When you restore the Device to factory settings, all the data except data in the external storage device will be cleared. You can clear the data in the external storage device through formatting or other methods.

Procedure

Step 1 Select **Main Menu > AI > Report Query > Crowd Density**.

Step 2 Select the channel, report type, start time and end time, and then click **Search**.

Related Operations

- Switch chart type.
Click **Bart Chart** or **Line Chart** to switch the chart type.
- Export.
Select the file type, and then click **Export** to export the report in picture or csv format.

5.9.11 People Counting

The system can calculate the number of entry or exit people in the detection zone. An alarm is triggered when the number has exceeded the threshold.



Make sure that the connected camera supports people counting.

5.9.11.1 Enabling Smart Plan

To use AI by camera, you need to enable the smart plan first. For details, see "5.9.2 Smart Plan".

5.9.11.2 Configuring People Counting

Background Information

The system counts the number of people in and out of the detection area. When the number of entry, exit or staying people exceeds the threshold, an alarm is triggered.

Procedure

Step 1 Select **Main Menu > AI > Parameters > People Counting > People Counting**.

Figure 5-150 People counting

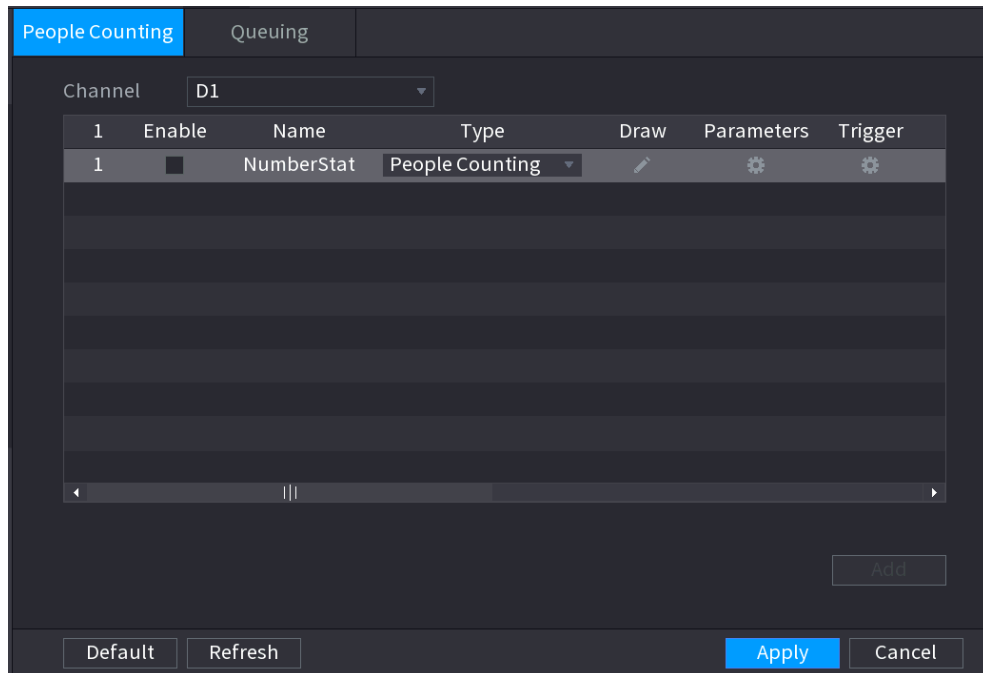

Step 2 Select a channel and then click **Add**.

Step 3 Select the **Enable** checkbox and then set **Type** to **People Counting**.

Step 4 Draw people counting rule.

- 1) Click to draw people counting rule. Right-click the image to stop drawing.

Figure 5-151 People counting rule

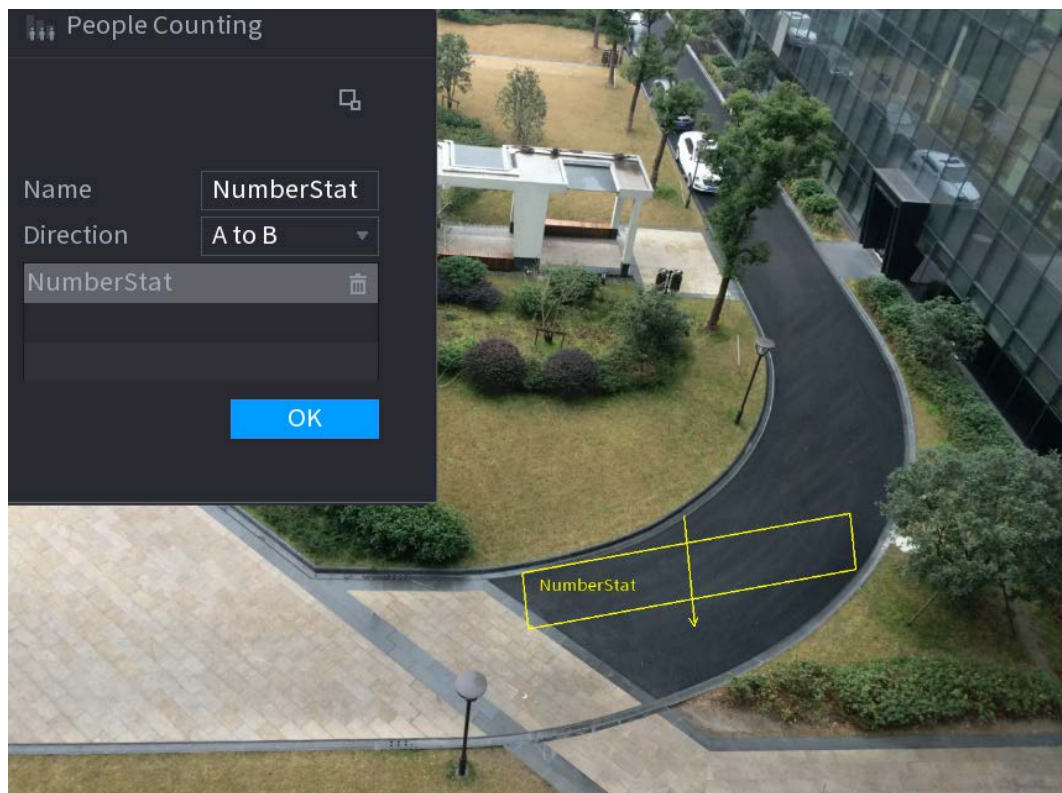

- 2) Customize the rule name and then select direction.

- 3) Click **OK**.

Step 5 Click under **Parameters** and then configure the parameters.

Table 5-42 People counting parameters

Parameter	Description
OSD	<ul style="list-style-type: none"> • Select Enter No., and then the number of people entering the detection zone will be displayed on the live page. • Select Exit No., and then the number of people leaving the detection zone will be displayed on the live page.
Setting	<ul style="list-style-type: none"> • Enter No.: An alarm is triggered when the number of people entering the detection zone exceeds the defined threshold. • Exit No.: An alarm is triggered when the number of people leaving the detection zone exceeds the defined threshold. • Stay No.: An alarm is triggered when the number of people staying the detection zone exceeds the defined threshold.

Step 6 Click  under **Trigger** to configure alarm schedule and linkage. For details on alarm linkage, see Table 5-43.

Step 7 Click **Apply**.

5.9.11.3 Configuring In Area No.

Background Information

When the number of people in the detection area is larger or lower than the defined threshold, or when the staying period exceeds the defined duration, an alarm is triggered.

Procedure

Step 1 Select **Main Menu > AI > Parameters > People Counting > People Counting**.

Figure 5-152 People counting

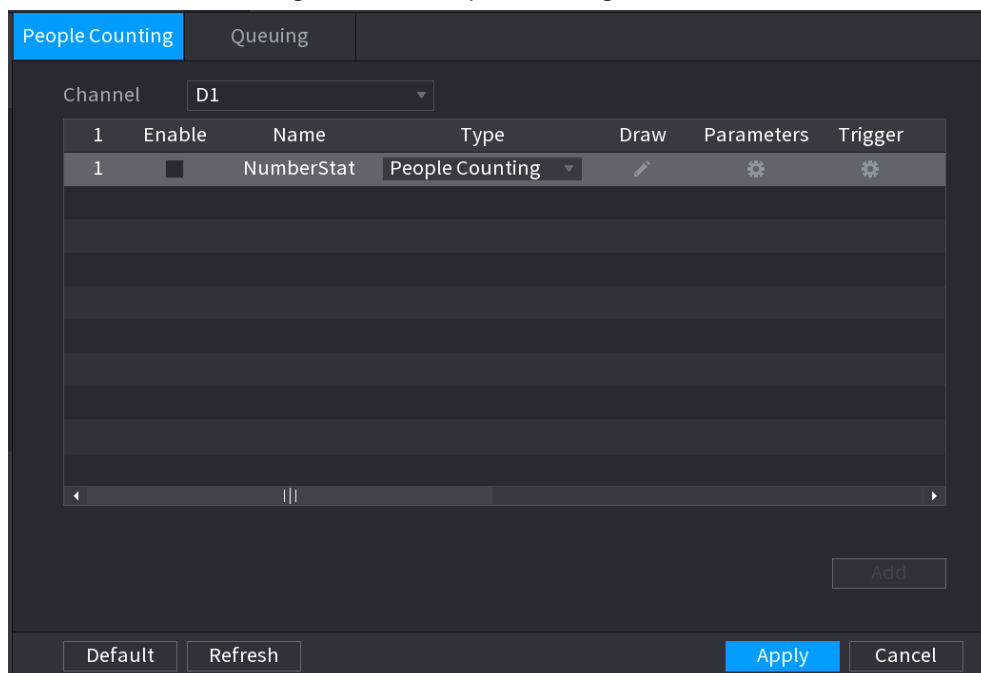

Step 2 Select a channel and then click **Add**.

Step 3 Select the **Enable** checkbox and then set **Type** to **In Area No.**

Step 4 Draw people counting rule.

- 1) Click to draw a rule. Right-click the image to stop drawing.
- 2) Configure the parameters.
- 3) Click **OK**.

Step 5 Click and then enable in-area people number alarm and stay alarm.

Step 6 Click under **Trigger** to configure the alarm schedule and linkage

Step 7 Click **Apply**.

5.9.11.4 Queuing

Background Information

After configuring queuing alarm, the system can realize the corresponding linkage actions once the number of people in the queue or the waiting time has triggered an alarm.

Procedure

Step 1 Select **Main Menu > AI > Parameters > People Counting > Queuing**.

Figure 5-153 Queuing

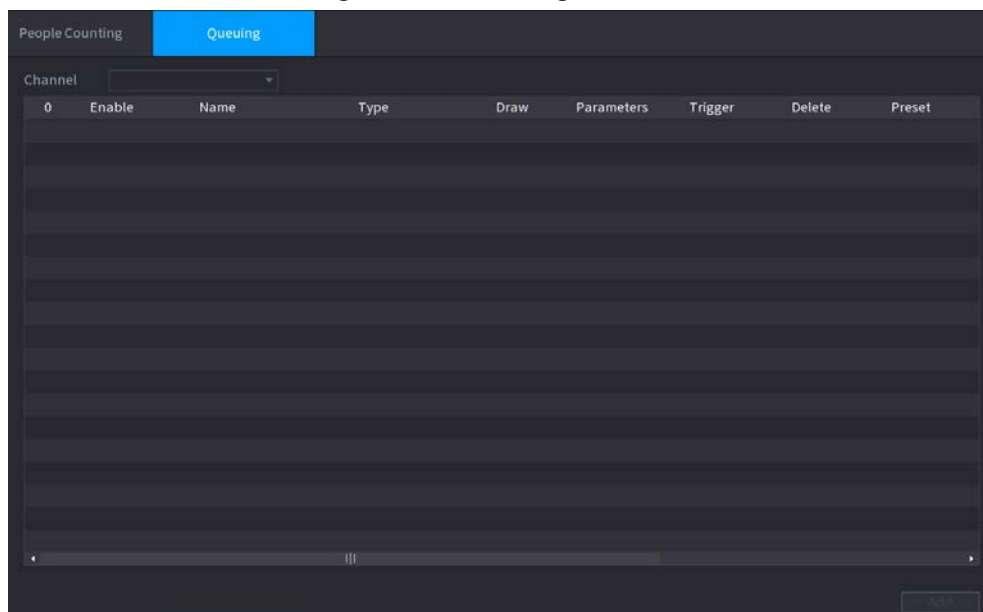

Step 2 Select a channel, and then click **Add**.

Step 3 Select the **Enable** checkbox.

Step 4 Click to draw queuing rule and area.

Step 5 Click under **Parameters**, and then enable **Queue People No. Alarm** or **Queue Time Alarm**.

Step 6 Click under **Trigger** to configure alarm schedule and linkage.

Step 7 Click **Apply**.

5.9.11.5 Report Query

Background Information

You can search for and export the people counting statistics.



- The statistics might be overwritten when the storage space runs out. Back up in time.
- When you restore the Device to factory settings, all the data except data in the external storage device will be cleared. You can clear the data in the external storage device through formatting or other methods.

Procedure

Step 1 Select **Main Menu > AI > Report Query > People Counting**.

Figure 5-154 People counting

Step 2 Select channel, rule, report type, start and end time, and direction, and then click **Search**.

Related Operations

- Switch chart type.
Click **Bart Chart** or **Line Chart** to switch the chart type.
- Export.
Select file type, and then click **Export** to export the report in picture or csv format.

5.9.12 Heat Map

The Device can monitor the distribution of active objects in the detection zone during a period of time, and use different colors to display the objects on the heat map.

5.9.12.1 Enabling Smart Plan

To use AI by camera, you need to enable the smart plan first. For details, see "5.9.2 Smart Plan".

5.9.12.2 Configuring Heat map

Background Information

Heat map technology can monitor the active objects distribution status on the specified zone during a period of time, and use different colors to display on the heat map.

Procedure

Step 1 Select **Main Menu > AI > Parameters > Heat Map**.

Figure 5-155 Heat map

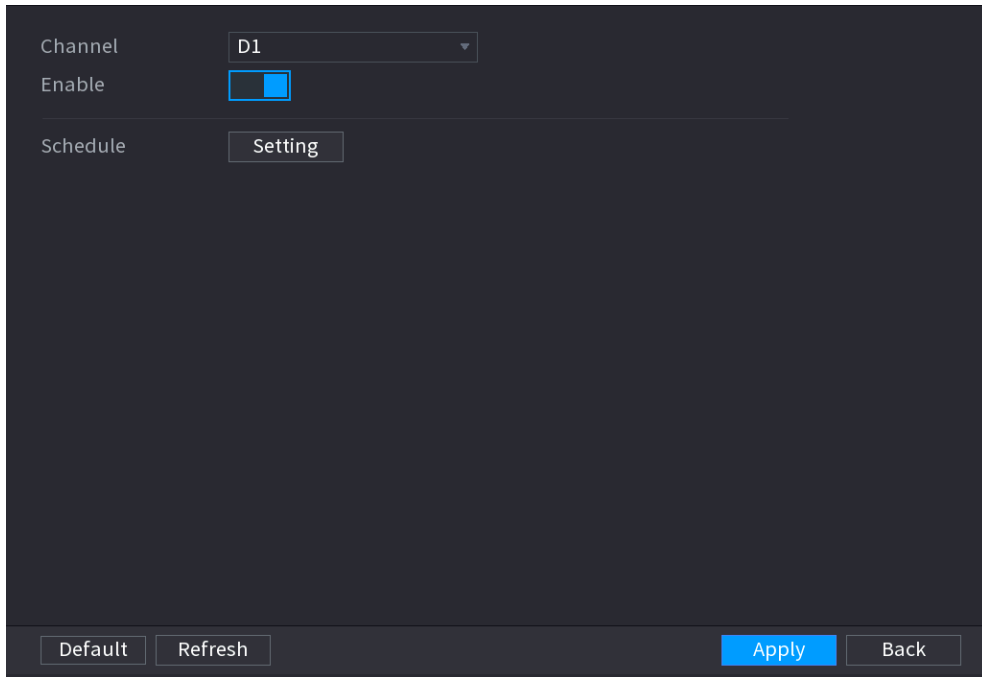

Step 2 Select a channel and then click  to enable the function.

Step 3 Click **Setting** to configure the alarm schedule.

Figure 5-156 Schedule



Step 4 Click **Apply**.

5.9.12.3 Report Query

You can search for and export the heat map report of general and fisheye cameras.

5.9.12.3.1 General

Procedure

Step 1 Select **Main Menu > AI > Report Query > Heat Map > General**.

Figure 5-157 General

The screenshot shows a web interface for generating a heat map report. It features a dark theme with a top navigation bar containing two tabs: 'General' (highlighted in blue) and 'Fisheye'. Below the tabs, there are several input fields: a 'Channel' dropdown menu set to 'D1', a 'Period' dropdown menu set to 'Today', and a date range selector showing '2000-02-17 00:00:00' to '2000-02-17 23:59:59'. A note '*Max 1 month.' is positioned below the date range. To the right of the date range are two buttons: 'Search' and 'Export'. At the bottom of the interface, the text 'Heat Map' is centered above a bar chart that displays a series of vertical bars of varying heights, representing the data for the selected period.

Step 2 Select the channel, start time, and end time.

Step 3 Click **Search**.

Step 4 Click **Export** to export the heat map.

5.9.12.3.2 Fisheye

Procedure

Step 1 Select **Main Menu > AI > Report Query > Heat Map > Fisheye**.

Figure 5-158 Fisheye

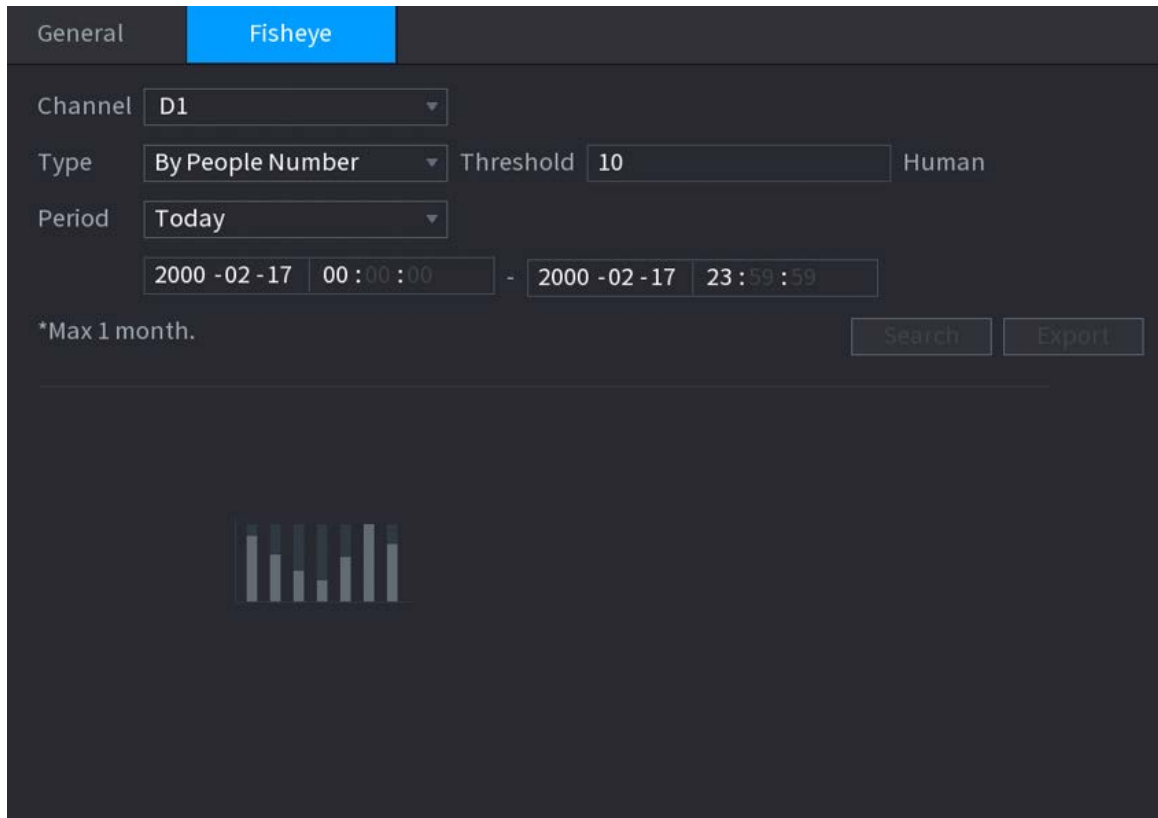

General **Fisheye**

Channel

Type Threshold Human

Period

-

*Max 1 month.

Step 2 Set channel, type and period, and then click **Search**.

Step 3 Click **Export** to export the heat map.

5.9.13 SMD

You can use SMD (Smart Motion Detection) to detect humans and vehicles in the video, and store the detection results in structured storage for fast retrieval.

5.9.13.1 Enabling Smart Plan

To use AI by camera, you need to enable the smart plan first. For details, see "5.9.2 Smart Plan".

5.9.13.2 Configuring SMD

Procedure

Step 1 Select **Main Menu > AI > Parameters > SMD**.

Figure 5-159 SMD

The screenshot shows the SMD configuration interface with the following settings:

- Channel: D1
- Type: AI by Recorder
- Enable:
- Sensitivity: Medium
- Effective Target: Human, Motor Vehicle
- Schedule: Setting
- Anti-Dither: 5 sec.
- Alarm-out Port: Setting
- Post-Alarm: 10 sec.
- Show Message: Report Alarm: Send Email:
- Record Channel: Setting
- PTZ Linkage: Setting
- Post-Record: 10 sec.
- Tour: Setting
- Picture Storage:
- Buzzer: Log:
- Alarm Tone: None

SMD linkage configuration synchronizes with MD linkage configuration.

Step 2 Select a channel and AI type.

Step 3 Click to enable the function.

Step 4 Configure the sensitivity.

The higher the value, the easier it is to trigger an alarm. But meanwhile, the false alarm might occur. The default value is recommended.







Step 5 Select effective target from **Human** and **Motor Vehicle**.

Step 6 Click **Setting** next to schedule to configure the alarm period.

Step 7 Configure alarm linkage.

Table 5-43 Alarm linkage parameters

Parameter	Description
Anti-Dither	The system records only one motion detection event within the defined period.
Alarm-out Port	When an alarm occurs, the NVR links the alarm output device to generate an alarm. The alarm lasts a period of time depending on the defined value for Post-Alarm .
Post-Alarm	 <ul style="list-style-type: none"> Make sure that the alarm devices are connected to the alarm output port of NVR. In Main Menu > ALARM > Alarm-out Port, set the mode to Auto so that the system can link the alarm output device to generate an alarm.

Parameter	Description
Show Message	Enable on-screen prompt when an alarm occurs.
Report Alarm	<p>Enable the system to report the alarm to the alarm center.</p>  <p>Make sure that alarm center has been configured in Main Menu > NETWORK > Alarm Center.</p>
Send Email	<p>Enable the system to send an email to notify you when an alarm occurs.</p>  <p>Make sure that the email settings have been configured in Main Menu > NETWORK > Email.</p>
Record Channel	<p>When an alarm occurs, the system activates recording of the selected channel. After the alarm ends, the recording continues for a period of time depending on the defined value for Post-Record.</p>  <p>Make sure that intelligent recording schedule and auto recording have been configured. For details, see "5.8.1 Recording Schedule".</p>
Post-Record	
PTZ Linkage	<p>When an alarm occurs, the NVR associates the channel to perform the corresponding PTZ action. For example, rotate the PTZ to the preset point.</p>  <p>Make sure that PTZ actions have been configured. For details, see "5.6.7 PTZ".</p>
Tour	<p>When an alarm occurs, the local interface of the NVR displays the image of the selected channels in turn.</p>  <p>Make sure that the time interval and mode for tour have been configured in Main Menu > DISPLAY > Tour Setting.</p>
Picture Storage	<p>When an alarm occurs, the system takes a snapshot of the channel and stores the snapshot on the Device.</p>  <p>Make sure that snapshot schedule and snapshot mode have been configured. For details, see "5.8.1 Recording Schedule".</p>
Buzzer	The system activates the buzzer when an alarm occurs.
Log	When an alarm occurs, the system records the event in the logs.
Alarm Tone	<p>When an alarm occurs, the system plays the selected audio file.</p>  <p>Make sure that the audio files have been uploaded to the system. For details, see "5.18.1 File Management".</p>

Step 8 Click **Apply**.

5.9.13.3 AI Search (SMD)

You can search for and play back videos that triggered SMD alarms.

Procedure

- Step 1 Select **Main Menu > AI > AI Search > SMD**.
- Step 2 Select channel, type, start time and end time, and then click **Search**.
- Click  to play back the video.
 - Select a video and click **Export** to export video file to a USB flash drive.

5.9.14 Vehicle Density

You can configure the rules for traffic congestion and parking upper limit, , and view the counting data on the live page.

- Traffic congestion: The system counts the vehicles in the detection area. When the counted vehicle number and the continuous congestion time exceed the configured values, an alarm is triggered and the system performs an alarm linkage.
- Parking upper limit: The system counts the vehicles in the detection area. When the counted vehicle number exceeds the configured value, an alarm triggered and the system performs an alarm linkage.

5.9.14.1 Enabling Smart Plan

To use AI by camera, you need to enable the smart plan first. For details, see "5.9.2 Smart Plan".



5.9.14.2 Configuring Vehicle Density

Procedure

- Step 1 Select **Main Menu > AI > Parameters > Vehicle Density**.

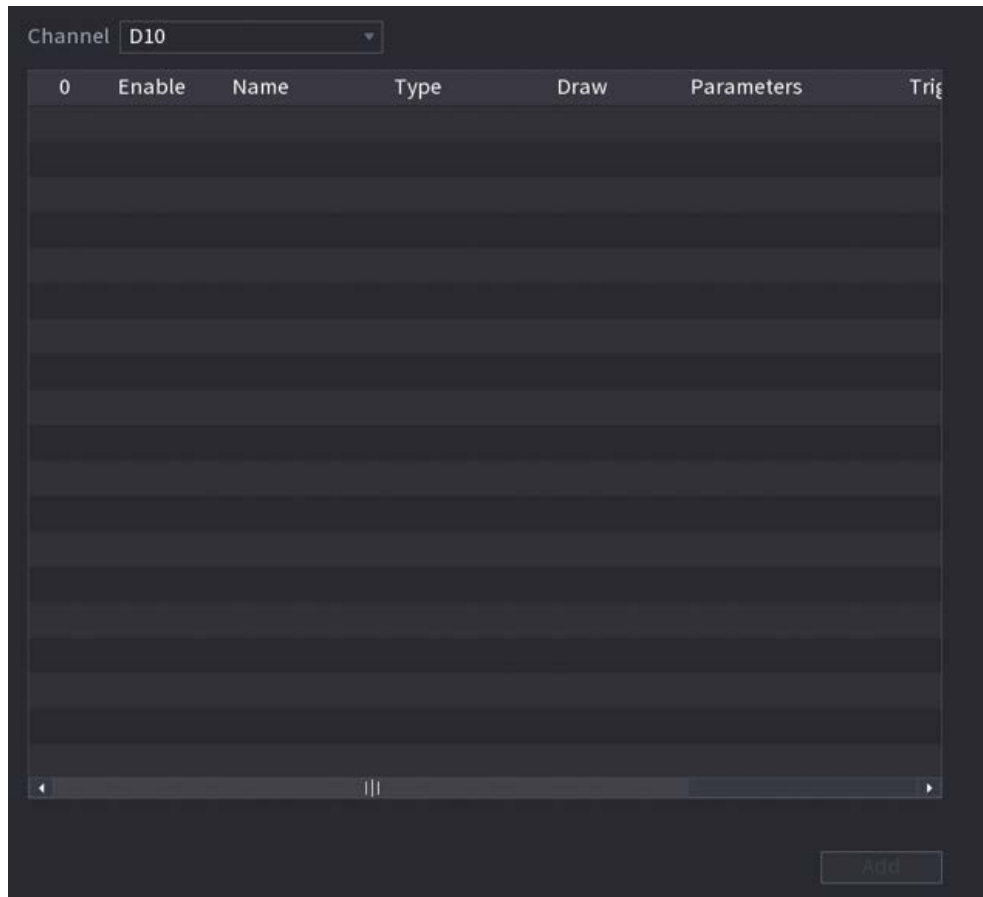
Figure 5-160 Vehicle density



- Step 2** Select a channel and then click **Add**.
- Step 3** Select the **Enable** checkbox and then select a detection type.
- Step 4** Click  to draw the detection rule.
- Step 5** Click  under **Parameters** and then configure the parameters.
- Step 6** Click  under **Trigger** to configure alarm schedule and linkage.
- Step 7** Click **Apply**.

5.9.14.3 Report Query

Background Information

You can search for and export statistics on vehicle density.



- The statistics might be overwritten when the storage space runs out. Back up in time.
- When you restore the Device to factory settings, all the data except data in the external storage device will be cleared. You can clear the data in the external storage device through formatting or other methods.

Procedure

- Step 1** Select **Main Menu > AI > Report Query > Vehicle Density**.

Figure 5-161 Vehicle density

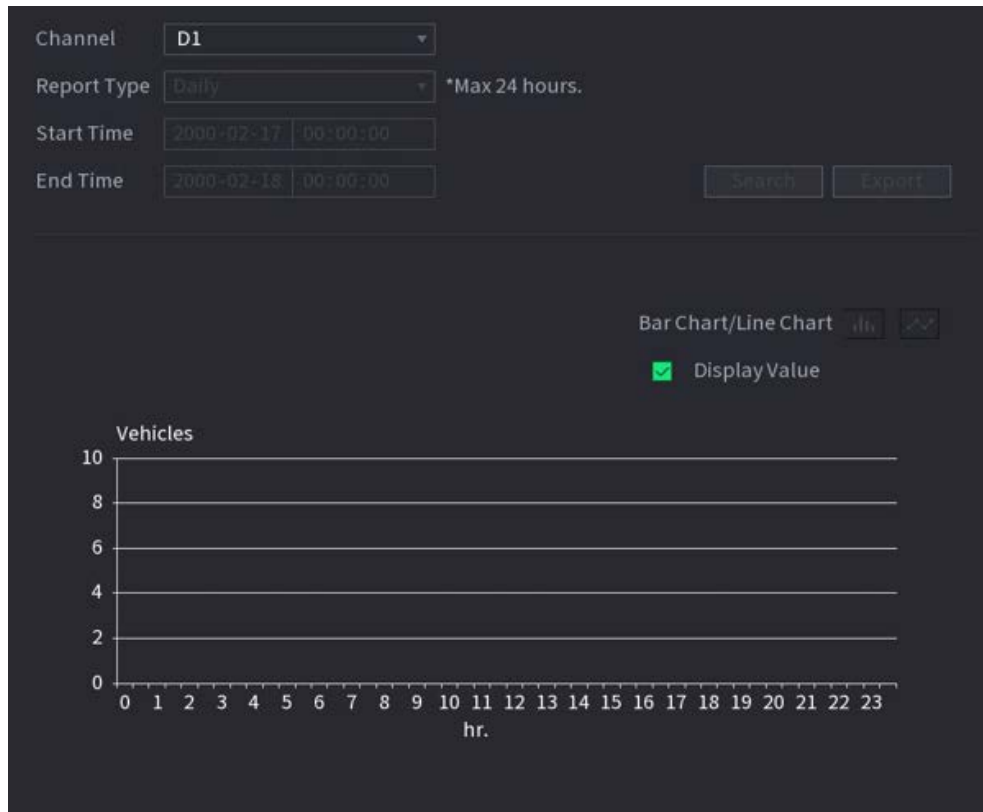

Step 2 Select channel, report type, start and end time, and then click **Search**.

Related Operations

- Switch chart type.
Click **Bar Chart** or **Line Chart** to switch the chart type.
- Export.
Select file type, and then click **Export** to export the report in picture or csv format.

5.9.15 Main-sub Tracking

Main-sub tracking refers to fisheye camera and speed dome linkage system. The fisheye camera serves as the main camera and captures panoramic videos. The speed dome serves as the sub camera and captures details of the video.

Prerequisites

- The monitoring areas of fisheye camera and speed dome are the same area.
- Fisheye camera and speed dome are added through private protocol.

Background Information



This function is available on select models.

Procedure

- Step 1** Select **Main Menu > AI > Parameters > Main-Sub Tracking**.
- Step 2** Add monitoring area.

- 1) Click **Add**.
- 2) Configure parameters.

Table 5-44 Main-sub tracking parameters

Parameter	Description
Type	Select a type according to the number of fisheye and PTZ cameras: <ul style="list-style-type: none"> • 1 Fisheye + 1 PTZ. • 1 Fisheye + 2 PTZ. • 1 Fisheye + 3 PTZ.
Scene Name	Customize the scene name.
Main Camera	Select a fisheye camera. <ol style="list-style-type: none"> 1. Click Select in Main Camera line. 2. Select a fisheye camera. 3. Click Apply.
Sub Camera	Select speed domes as needed. <ol style="list-style-type: none"> 1. Click Select in Sub Camera line. 2. Select speed domes. 3. Click Apply.



Step 3 Click **Apply**.

The monitoring area is successfully added.

Step 4 Configure calibration points to set the binding relationship of fisheye camera and speed dome.



Set a distant place as the first calibration point to improve accuracy.

- 1) Click  or double-click the target scene.
- 2) Click the target place on the video of fisheye camera, or move  to the target place.



The video at upper-left corner is the fisheye camera screen, and the video at upper-right corner is the speed dome screen.

- 3) Adjust position through the icons below the speed dome screen to make the center of speed dome identical to the  of fisheye camera.





The  on the speed dome screen is the center of speed dome.

Table 5-45 Icon description

Icon	Description
	Zoom in and zoom out.
	Adjust resolution.
	Adjust height.
	Electronic mouse. You can use this icon to move the mouse to control PTZ direction.

Icon	Description
	Quick positioning key. Click this icon to select a place, and the screen will be focused and centered on the selected place.

4) Click **Add**.

The calibration point will be displayed on the list at lower-right corner.

Step 5 Click to save the newly added calibration point.

Step 6 Repeat Step 2 to Step 5 to add more calibration points.



Set 3–8 calibration points for a speed dome.

Step 7 Click **Apply**.

5.9.16 Video Quality Analytics

When conditions such as blurry, overexposure, or the color changes appear on the screen, the system triggers the alarm.



- This function takes effect only when the remote IPC supports video quality analytics.
- This function is available on select models.

5.9.16.1 Configuring Video Quality Analytics

Procedure

Step 1 Select **Main Menu > AI > Parameters > Video Quality Analytics**.

Step 2 Select a channel and click **Enable**.

Figure 5-162 Video quality analytics

Step 3 Click **Setting** next to **Rule**.

Step 4 Select items and set thresholds as needed.

Figure 5-163 Video quality analytics settings

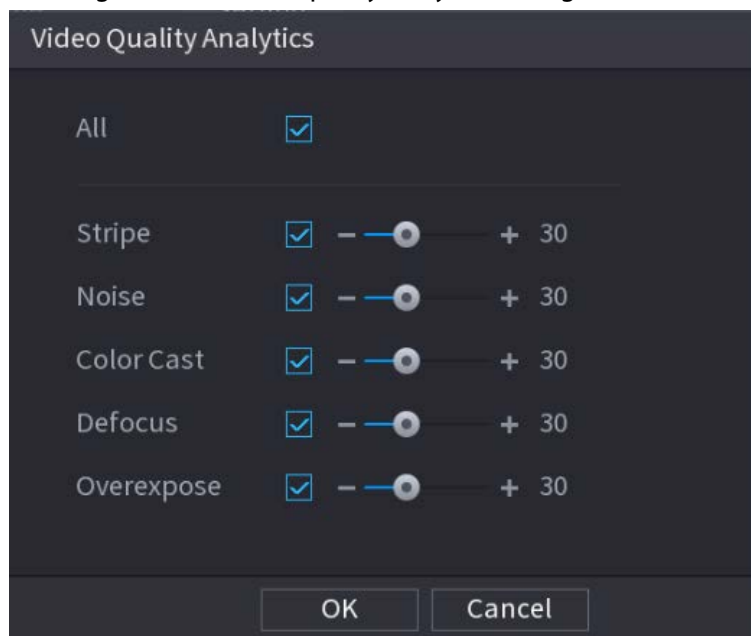

The value range of threshold is 0–100, and the default value is 30. When the value exceeds the set threshold, an alarm will be triggered.

Table 5-46 Video quality analytics parameters

Parameter	Description
Stripe	Stripes refer to the striped interferences in the video which might be due to device aging or signal interference. The stripe might be horizontal, vertical, or oblique.
Noise	Video noise refers to the distortion of optical system or the degradation of image quality caused by hardware equipment during transmission.
Color Cast	An image in the video is generally a colorful image that contains color information, such as RGB. When these three components appear at some unusual scale in an image, the image is biased.
Defocus	An image with high resolution contains more details, but image blur is a common problem of image quality decrease which is caused by many factors in the process of image acquisition, transmission and processing, and is defined as virtual focus in video diagnosis.
Overexpose	The brightness of the image refers to the intensity of the image pixels. Black is the darkest and white is the brightest. Black is represented by 0 and white is represented by 255. When the brightness value exceeds the threshold, the image is over exposed.

Step 5 Click **OK**.

Step 6 Click **Setting** next to **Schedule** to configure the arming period.

The system triggers corresponding alarm actions only during the arming period.

- On the time line, drag to set the period.
- You can also click  to set the period.

Step 7 Configure alarm linkage actions. For details, see [Step 7](#).

Step 8 Click **Apply**.

5.9.16.2 Analytics List

Background Information

Search for the results of video quality analytics.

Procedure

- Step 1** Select **Main Menu > AI > AI Search > Analytics List**.
- Step 2** Select the start time and end time.
- Step 3** Select one or more channels.
- Step 4** Click **Search**.

Figure 5-164 Analytics list

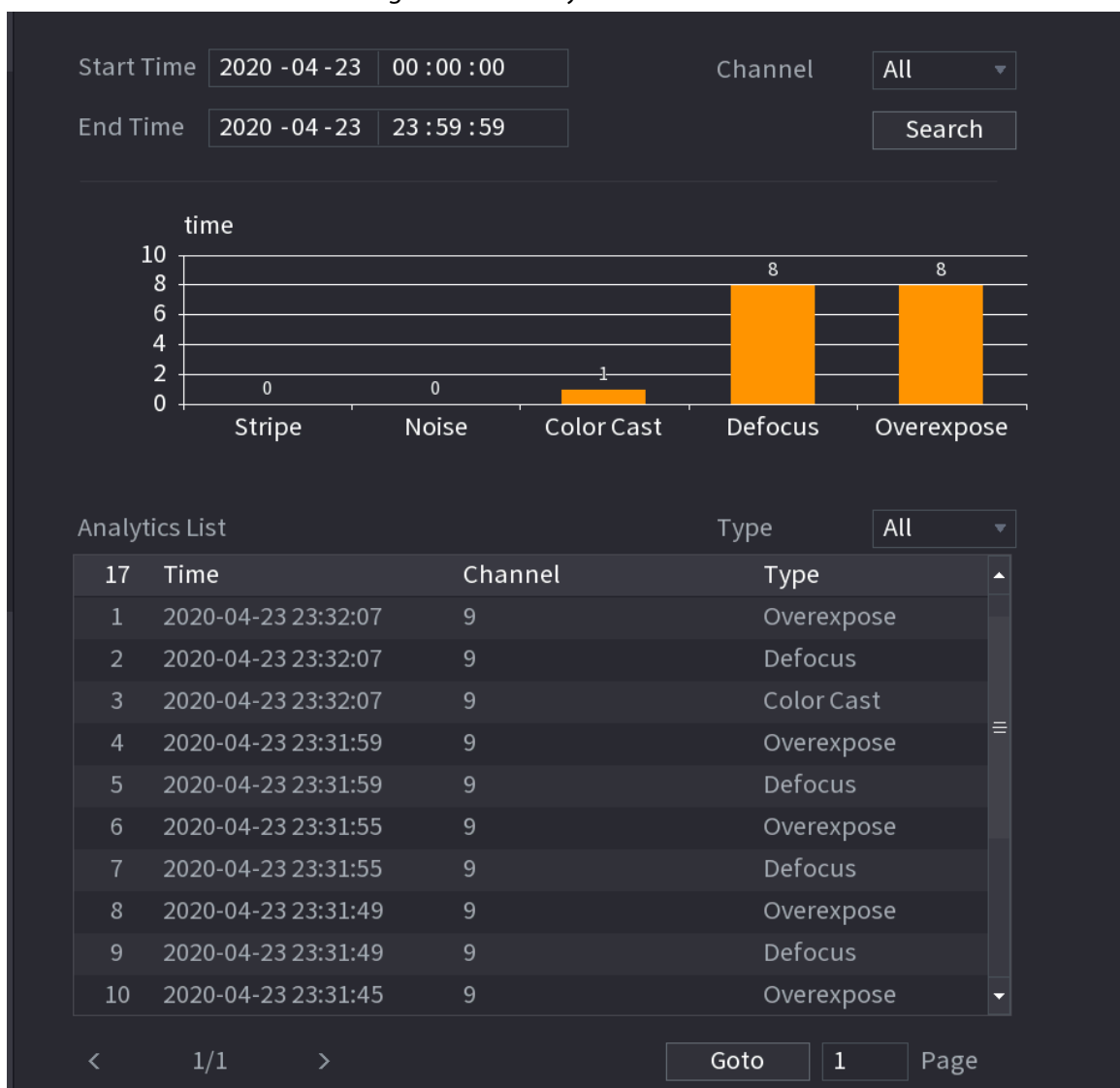

5.9.17 Entries Frequency

Background Information

After setting entries frequency, when the entries detected of a person reach or exceed the threshold, an alarm is triggered.

Procedure

Step 1 Select **Main Menu > AI > Parameters > Face Recognition > Entries Frequency**.

Figure 5-165 Entries frequency

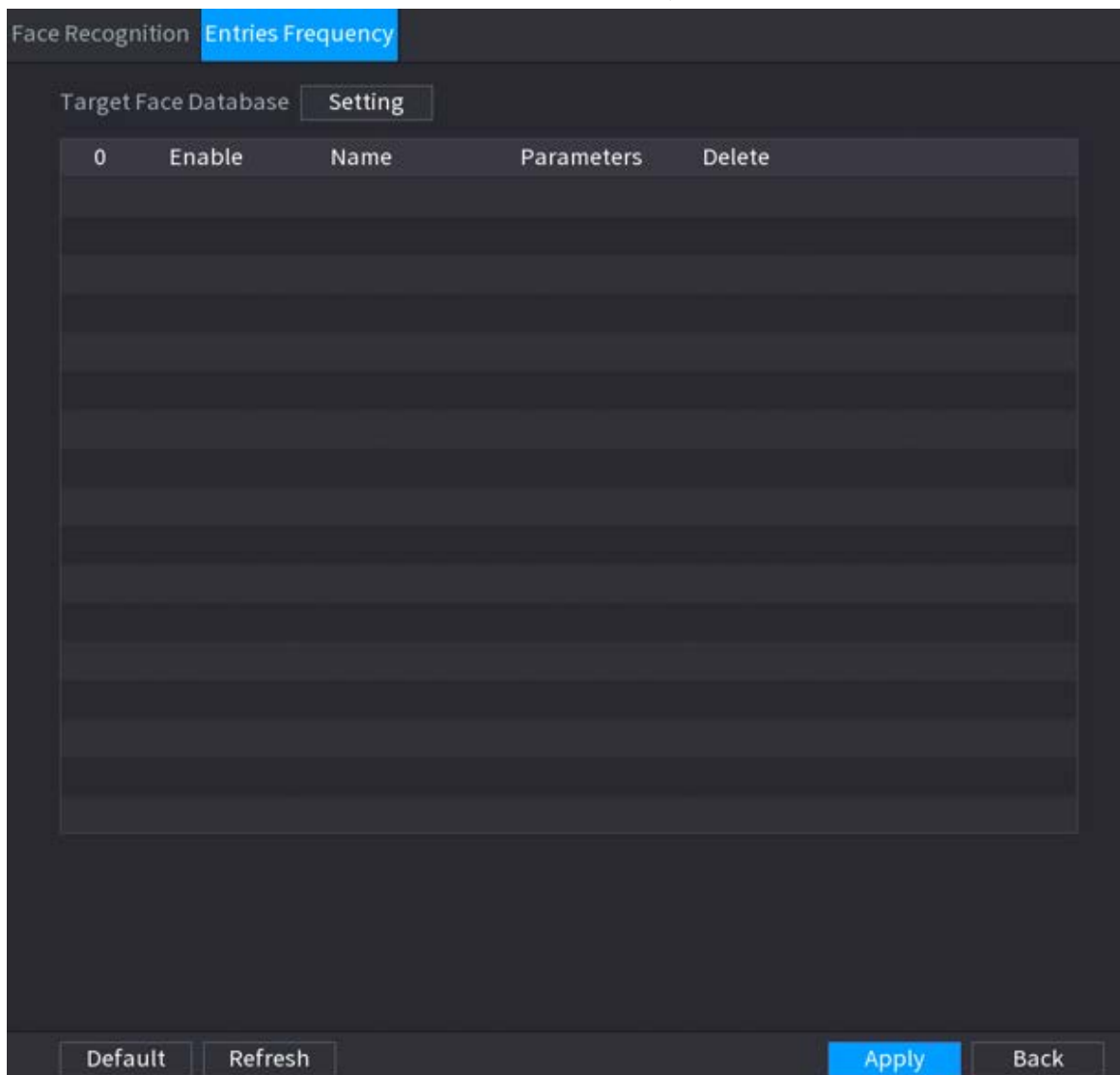

Step 2 Click **Setting** to select a database and then click **OK**.

Step 3 Click  and then configure the parameters.

Figure 5-166 Configure entries frequency



The screenshot shows a dark-themed dialog box titled "Parameters". It contains three input fields: "Statistical Cycle" with the value "1" and the unit "Days", "Entries Detected" with the value "10" and the unit "time", and "Alarm Name" with the value "Entries Frequency". Below these fields is a "Reset" button. At the bottom right of the dialog are "OK" and "Cancel" buttons.

Table 5-47 Entries frequency parameters

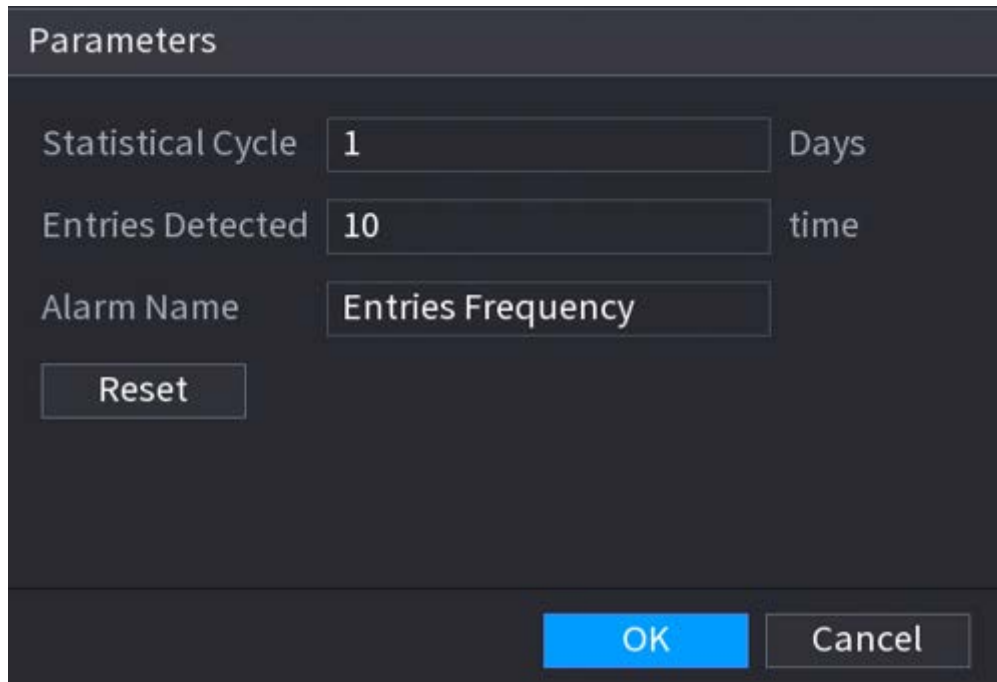
Parameter	Description
Statistical Cycle	Set the cycle for counting the entries frequency.
Entries Detected	Set the threshold of entries frequency. When the entries detected reaches or exceeds the threshold, an alarm is triggered.
Alarm Name	The name is Entries Frequency by default. You can change the name.

Step 4 Click **Apply**.

5.10 Alarm Settings

5.10.1 Alarm Information

Background Information

You can search for, view and back up the alarm information.

Procedure

Step 1 Select **Main Menu > ALARM > Alarm Info**.

Figure 5-167 Alarm information

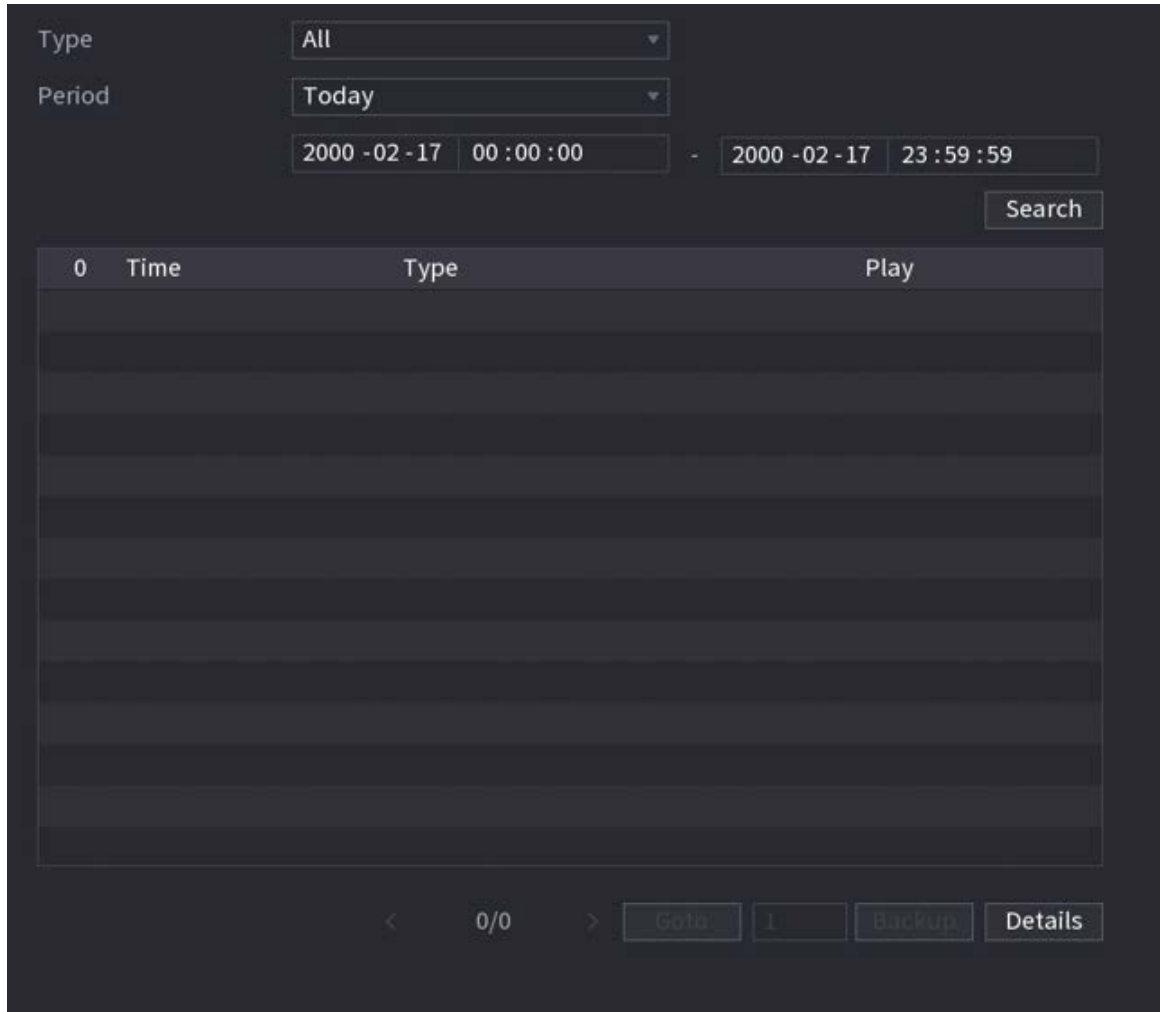

The screenshot displays a web interface for alarm information. At the top, there are two dropdown menus: 'Type' set to 'All' and 'Period' set to 'Today'. Below these are two date-time input fields showing '2000 -02 -17 00:00:00' and '2000 -02 -17 23:59:59', separated by a minus sign. A 'Search' button is located to the right of the date fields. Below the search area is a table with the following header:

0	Time	Type	Play

At the bottom of the interface, there are navigation controls including a left arrow, '0/0', a right arrow, and buttons labeled 'Goto', '1', 'Backup', and 'Details'.

Step 2 Select the event type, and then set the search period.

Step 3 Click **Search**.

The search results are displayed.

Related Operations

- Play back alarm videos.
Select an alarm event log, click  to play the recorded video of alarm event.
- Back up.
Select an alarm event log and then click **Backup** to back up it to peripheral USB device.
- View alarm details.
Double-click a log or click **Details** to view the detailed information of the event.

5.10.2 Alarm Status

You can view NVR alarm event, and remote channel alarm event.

Select **Main Menu > ALARM > Alarm Status**.

Figure 5-168 Alarm status

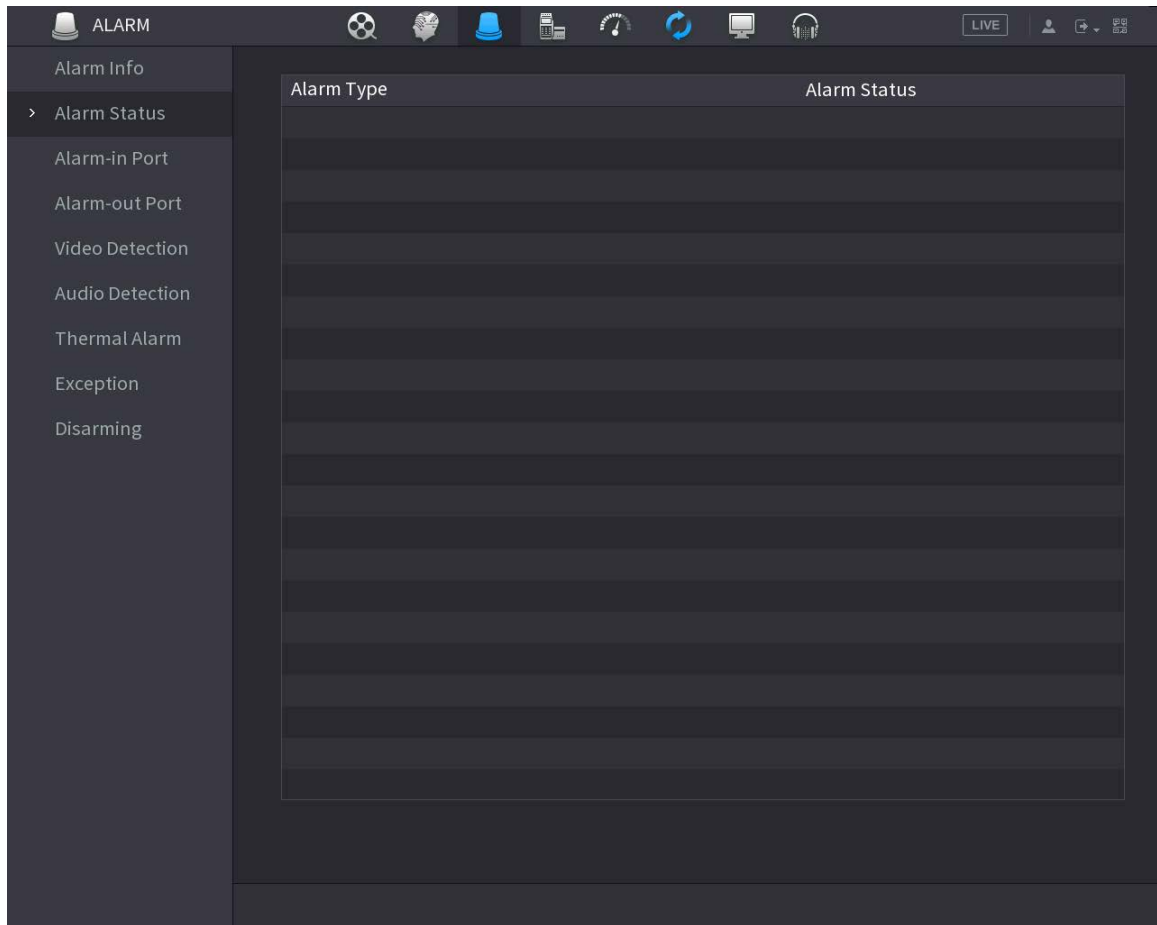

5.10.3 Alarm Input

Procedure

Step 1 Select **Main menu > ALARM > Alarm-in Port**.

Step 2 Click each tab to configure alarm input settings.

- Local alarm: After connect the alarm device to the NVR alarm input port, the system performs alarm linkage actions when there is an alarm signal from the alarm input port to the NVR.
- Alarm box: You can connect the alarm box to the RS-485 port of the Device. When the alarm is detected by the alarm box, the alarm information will be uploaded to the Device, and then the Device performs alarm linkage actions.
- Network alarm: NVR performs alarm linkage actions when it receives the alarm signal via the network transmission.
- IPC external alarm: When the peripheral device connected to the camera has triggered an alarm, the camera uploads the alarm signal to the NVR via the network transmission. The system performs the corresponding alarm linkage actions.
- IPC offline alarm: When the network connection between the NVR and the network camera is off, the system performs alarm linkage actions.

Figure 5-169 Local alarm

Local	Alarm Box	Network	CAM Ext	CAM Offline
Alarm-in Port	1	Alarm Name	Alarm-in Port1	
Enable	<input checked="" type="checkbox"/>	Device Type	NO	
Schedule	Setting		Anti-Dither	5 sec.
Alarm-out Port	Setting		Post-Alarm	10 sec.
<input type="checkbox"/> Show Message	<input type="checkbox"/> Report Alarm	<input type="checkbox"/> Send Email		
<input type="checkbox"/> Record Channel	Setting		Post-Record	10 sec.
<input type="checkbox"/> PTZ Linkage	Setting		<input type="checkbox"/> Picture Storage	
<input type="checkbox"/> Tour	Setting		Setting	
<input type="checkbox"/> Buzzer	<input checked="" type="checkbox"/> Log			
<input type="checkbox"/> Alarm Tone	None			
<input type="checkbox"/> Disarming				
Default		Copy to		Apply Back

Step 3 Click **Setting** next to **Schedule** to configure the alarm schedule.

Step 4 Configure the anti-dither period.

If multiple alarms occur during the anti-dither period, the system only record the event once.

Step 5 Configure alarm linkage. For details, see Table 5-43.

Step 6 Enable **Disarming** so that you can connect a switch to the alarm input port for disarming control.

Step 7 Click **Apply**.

5.10.4 Alarm Output

Background Information

You can set proper alarm output mode to auto, manual or off. After you connect the alarm device to the alarm output port of NVR, and set the mode to auto, the system performs alarm linkage actions when an alarm occurs.

- Auto: Once an alarm event occurs, the system generates an alarm.

- Manual: Alarm device is always on the alarming mode.
- Off: Disable alarm output function.

Procedure

Step 1 Select **Main Menu > ALARM > Alarm-out Port**.

Figure 5-170 Alarm-out port

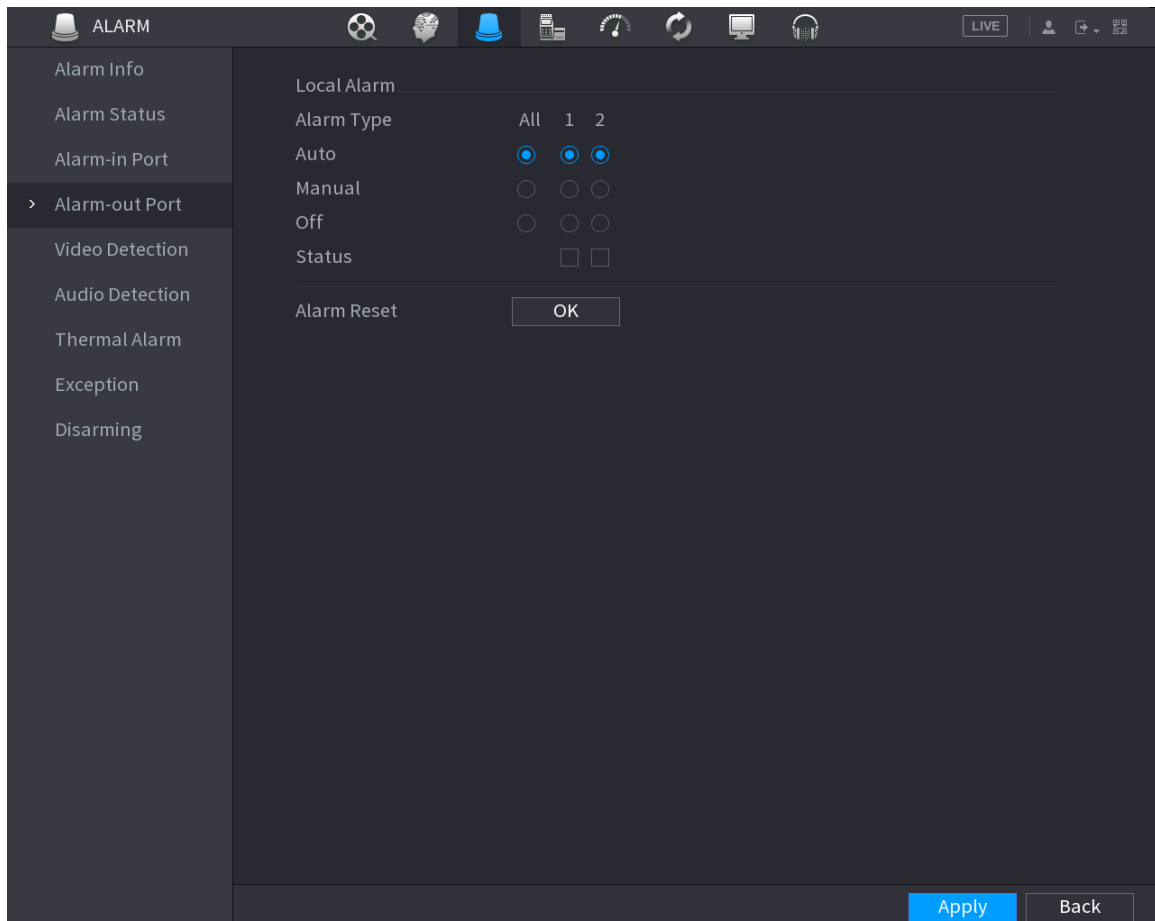

Step 2 Select the alarm mode of the alarm output channel.

Step 3 Click **Apply**.

- Click **OK** next to **Alarm Reset** to clear all alarm output statuses.
- View the alarm output status on the **Status** column.

5.10.5 Video Detection

The system can analyze the video and check whether there is considerable change or not. Once video has changed considerably (for example, there is any moving object, video is distorted), the system performs alarm linkage actions.

5.10.5.1 Motion Detection

Background Information

When the moving object appears and moves fast enough to reach the preset sensitivity value, the system performs alarm linkage actions.

Procedure

Step 1 Select **Main Menu > ALARM > Video Detection > Motion Detection**.

Step 2 Select a channel and then click  to enable the function.

Step 3 Configure the detection region.

- 1) Click **Setting** next to **Region**.
- 2) Point to the middle top of the page.
- 3) Select one region, for example, click .
- 4) Drag on the screen to select the region that you want to detect.
- 5) Configure the parameters.

Table 5-48 Detection region parameters

Parameter	Description
Name	Enter a name for the region.
Sensitivity	Every region has an individual sensitivity value. The bigger the value is, the easier to trigger an alarm.
Threshold	Adjust the threshold for motion detection. Every region of every channel has an individual threshold.



You can configure up to four detection regions. When any one of the four regions activates motion detection alarm, the channel where this region belongs to will activate motion detection alarm.

- 6) Right-click the page to exit.

Step 4 Click **Setting** next to **Schedule** to configure the alarm schedule.

Step 5 Configure the anti-dither period.

If multiple alarms occur during the anti-dither period, the system only record the event once.

Step 6 Configure alarm linkage. For details, see *Network Video Recorder_User's Manual*. This section uses associating siren as an example.

Enable **Alarm Hub**, select the alarm hub as needed, and then select siren as needed. **Step 7**

Click **Apply**.

5.10.5.2 Video Loss

Background Information

When the video loss occurs, the system performs alarm linkage actions.

Procedure

Step 1 Select **Main Menu > ALARM > Video Detection > Video Loss**.

Figure 5-171 Video Loss

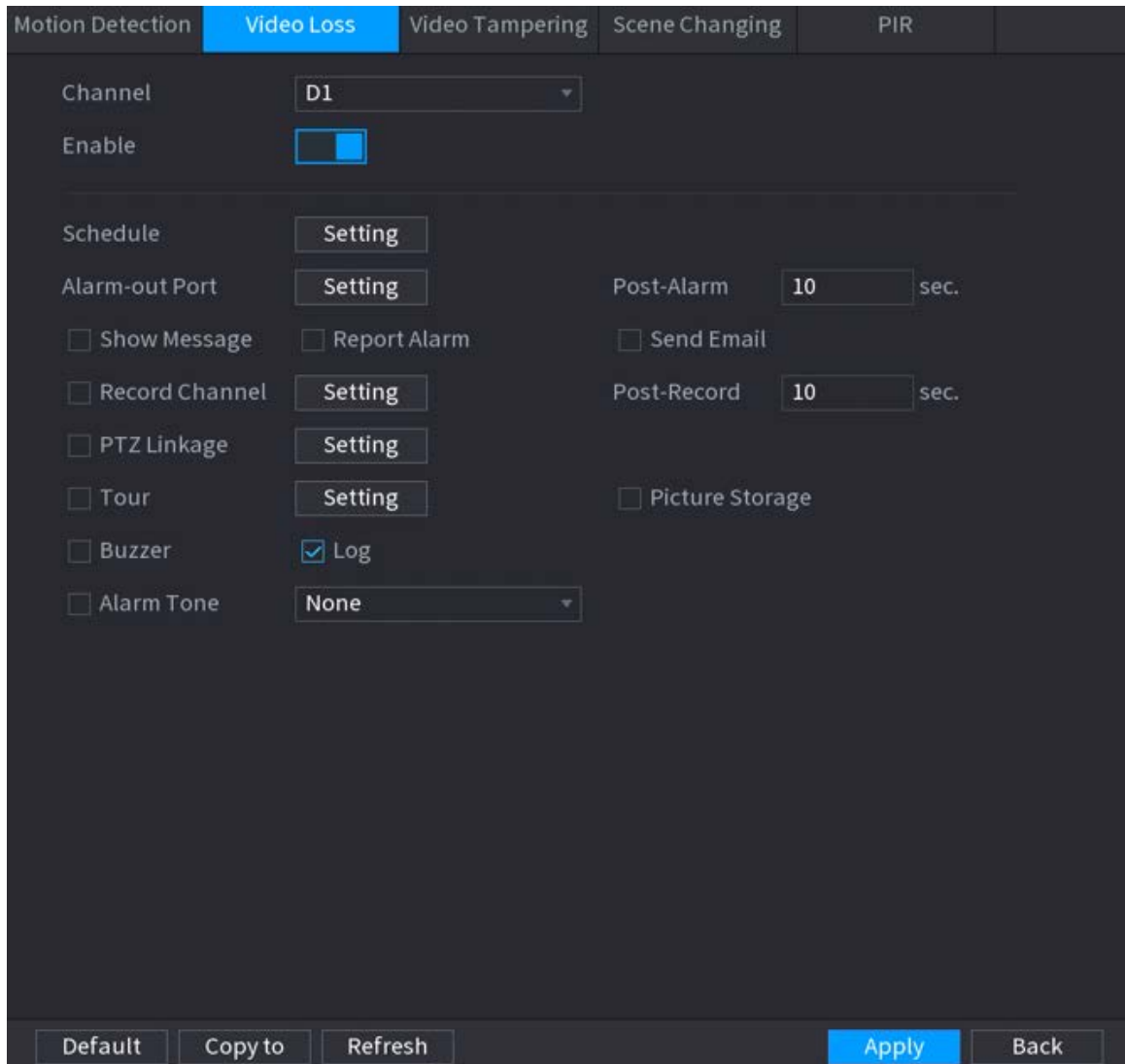

- Step 2** Select a channel and then click  to enable the function.
- Step 3** Click **Setting** next to **Schedule** to configure the alarm schedule.
- Step 4** Configure alarm linkage. For details, see *Network Video Recorder_User's Manual*.
- Step 5** Click **Apply**.

5.10.5.3 Video Tampering

Background Information

When the camera lens is covered, or the video is displayed in a single color because of sunlight status, the monitoring cannot be continued normally. To avoid such situations, you can configure the tampering alarm settings.

Procedure

- Step 1** Select **Main Menu > ALARM > Video Detection > Video Tampering**.

Figure 5-172 Video tampering

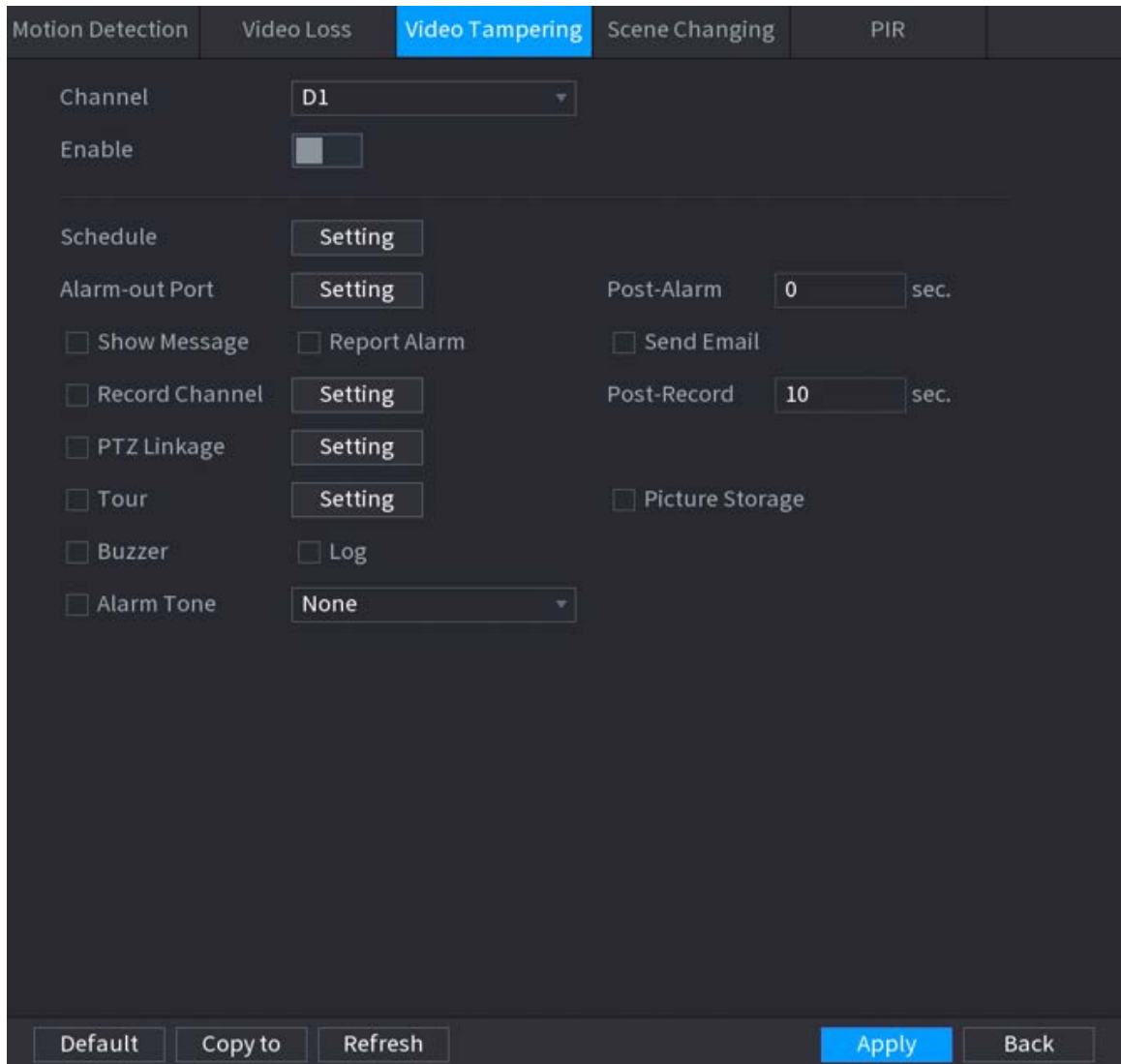

- Step 2** Select a channel and then click to enable the function.
- Step 3** Click **Setting** next to **Schedule** to configure the alarm schedule.
- Step 4** Configure alarm linkage. For details, see *Network Video Recorder_User's Manual*.
- Step 5** Click **Apply**.

5.10.5.4 Scene Change

Background Information

When the detected scene has changed, system performs alarm linkage actions.

Procedure

- Step 1** Select **Main Menu > ALARM > Video Detection > Scene Changing**.

Figure 5-173 Scene changing

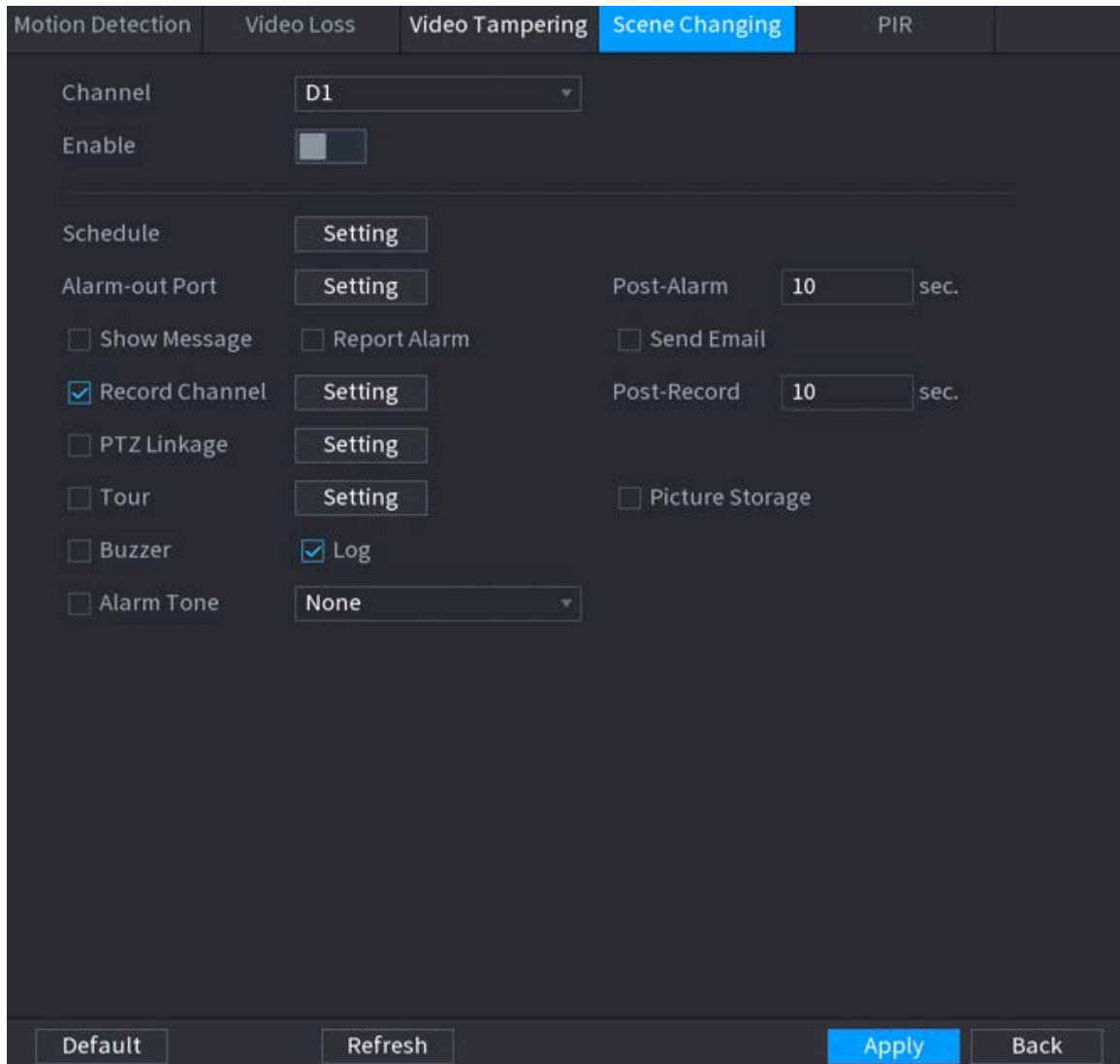

- Step 2** Select a channel and then click  to enable the function.
- Step 3** Click **Setting** next to **Schedule** to configure the alarm schedule.
- Step 4** Configure alarm linkage. For details, see *Network Video Recorder_User's Manual*.
- Step 5** Click **Apply**.

5.10.5.5 PIR Alarm

Background Information

PIR function helps enhancing the accuracy and validity of motion detect. It can filter the meaningless alarms that are activated by the objects such as falling leaves and flies. The detection range by PIR is smaller than the field angle.

PIR function is enabled by default if it is supported by the cameras. Enabling PIR function will get the motion detection to be enabled automatically to generate motion detection alarms.

Procedure

- Step 1** Select **Main Menu > ALARM > Video Detection > PIR**.

Figure 5-174 PIR

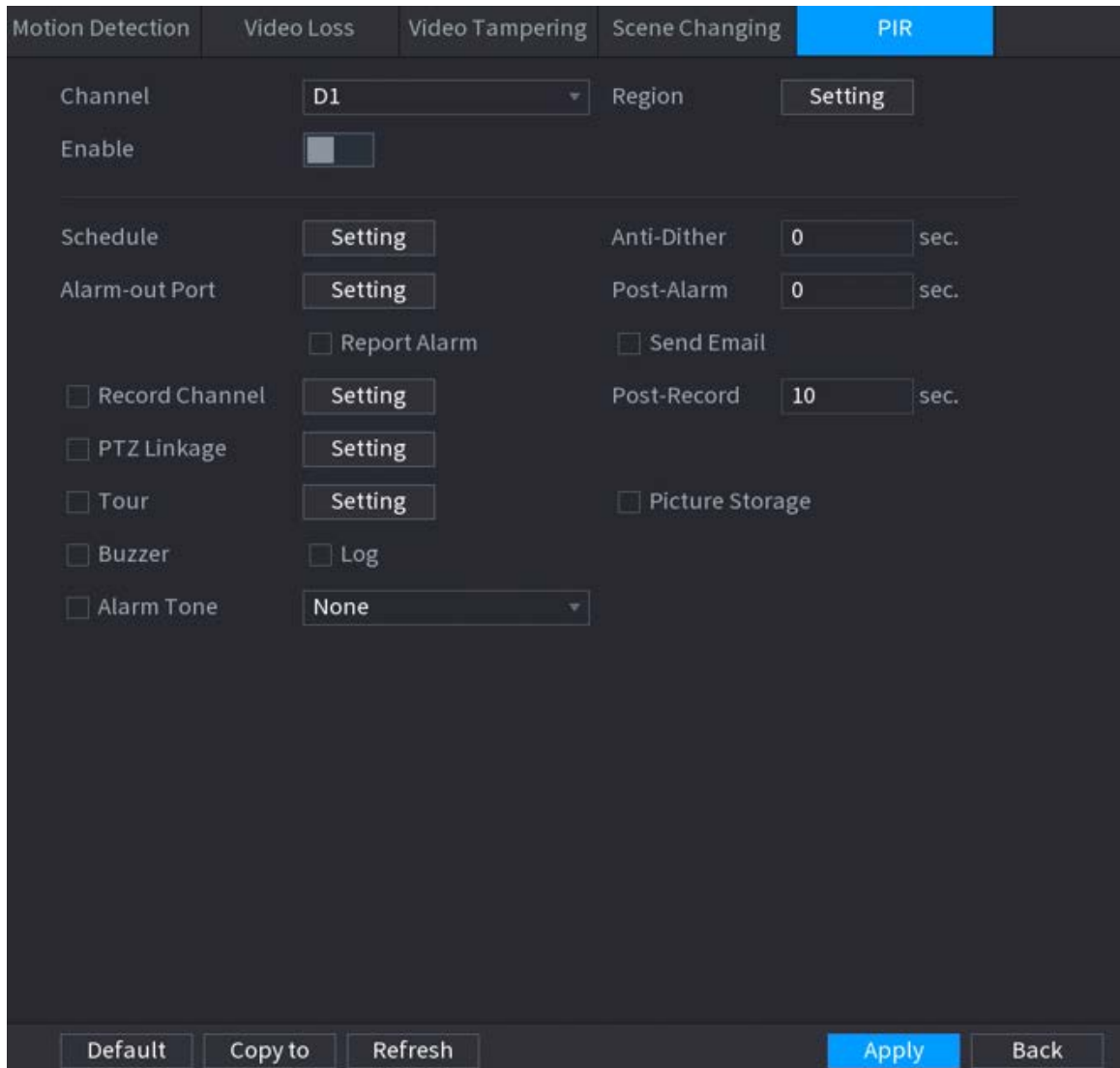

Step 2 Select a channel and then click to enable the function.

Step 3 Configure the detection region.

- 1) Click **Setting** next to **Region**.
- 2) Point to the middle top of the page.
- 3) Select one region, for example, click .
- 4) Drag on the screen to select the region that you want to detect.
- 5) Configure the parameters.

Table 5-49 Detection region parameters

Parameter	Description
Name	Enter a name for the region.
Sensitivity	Every region of every channel has an individual sensitivity value. The bigger the value is, the easier to trigger an alarm.
Threshold	Adjust the threshold for motion detection. Every region of every channel has an individual threshold.



You can configure up to four detection regions. When any one of the four regions activates an alarm, the channel where this region belongs to will activate an alarm.

6) Right-click to exit the page.

Step 4 Click **Setting** next to **Schedule** to configure the alarm schedule.

Step 5 Configure the anti-dither period.

If multiple alarms occur during the anti-dither period, the system only record the event once.

Step 6 Configure alarm linkage. For details, see *Network Video Recorder_User's Manual*.

Step 7 Click **Apply**.

5.10.6 Audio Detection

Background Information

The system can generate an alarm once it detects the audio is not clear, the tone color has changed or there is abnormal or audio volume change.

Procedure

Step 1 Select **Main Menu > ALARM > Audio Detection**.

Step 2 Select a channel and then click  to enable detection of audio exception and intensity change.

- **Audio Exception:** The system generates an alarm when the audio input is abnormal.
- **Intensity Change:** Set the sensitivity and threshold. An alarm is triggered when the change in sound intensity exceeds the defined threshold.

Step 3 Click **Setting** next to **Schedule** to configure the alarm schedule.

Step 4 Configure alarm linkage. For details, see Table 5-43.

Step 5 Click **Apply**.

5.10.7 Thermal Alarm

Background Information

After receiving the alarm signal from the connected thermal devices, the system can recognize the alarm type, and then trigger the corresponding alarm actions.

The system supports heat alarm, temperature (temperature difference) and cold/hot alarm.

- Heat alarm: The system generates an alarm once it detects there is a fire.
- Temperature (temperature difference): The system triggers an alarm once the temperature difference between two positions is higher or below the specified threshold.
- Cold/hot alarm: The system triggers an alarm once the detected position temperature is higher or below the specified threshold.



- Make sure that the connected camera supports temperature monitoring function.
- This function is available on select models.
- The thermal detection functions might vary depending on the connected camera. This section uses heat alarm as an example.

Procedure

Step 1 Select **Main Menu > ALARM > Thermal Alarm**.

Figure 5-175 Thermal alarm

Step 2 Select a channel and set alarm type to heat alarm, and then enable the function.

Step 3 Select fire mode. The system supports preset mode and zone excluded mode.

- Preset mode: Select a preset and then enable the function. The system generates an alarm once it detects there is a fire.
- Zone excluded mode: The system filters the specified high temperature zone. The system generates an alarm once the rest zone has fire.

Step 4 Configure alarm linkage. For details, see Table 5-43.

Step 5 Click **Apply**.

5.10.8 Exception

Background Information

When an error in HDD, network, and device occurs, the system performs alarm linkage actions.

Procedure

Step 1 Select **Main Menu > ALARM > Exception**.

Figure 5-176 Disk exception

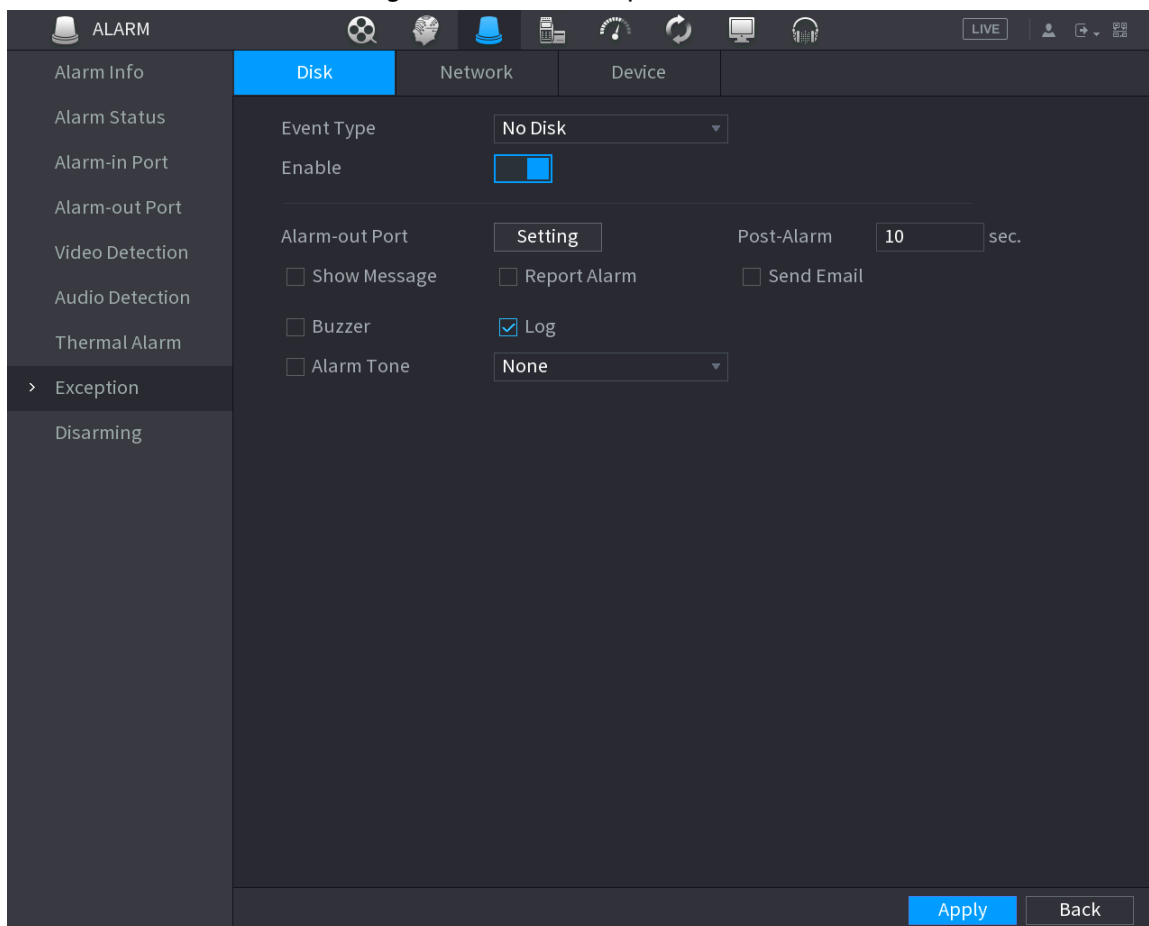

Step 2 Click each tab and then select an event type.

- **Disk:** The system detects HDD error, no HDD, no space, and other HDD events.
- **Network:** The system detects network errors such as disconnection, IP conflict, and MAC conflict.
- **Device:** The system detects device errors such as abnormal fan speed and network security error.

Step 3 Click to enable the function.

Step 4 (Optional) If the event type is **Low Space**, you need to configure the threshold of storage space.

When the storage space is lower than the threshold, an alarm is triggered.

Step 5 Configure alarm linkage. For details, see Table 5-43.

Step 6 Click **Apply**.

5.10.9 Disarming

You can disarm all alarm linkage actions as needed through one click.

Procedure

Step 1 Select **Main Menu > ALARM > Disarming**.

Step 2 Select **On** for **Disarming** to enable disarming.

Figure 5-177 Disarming

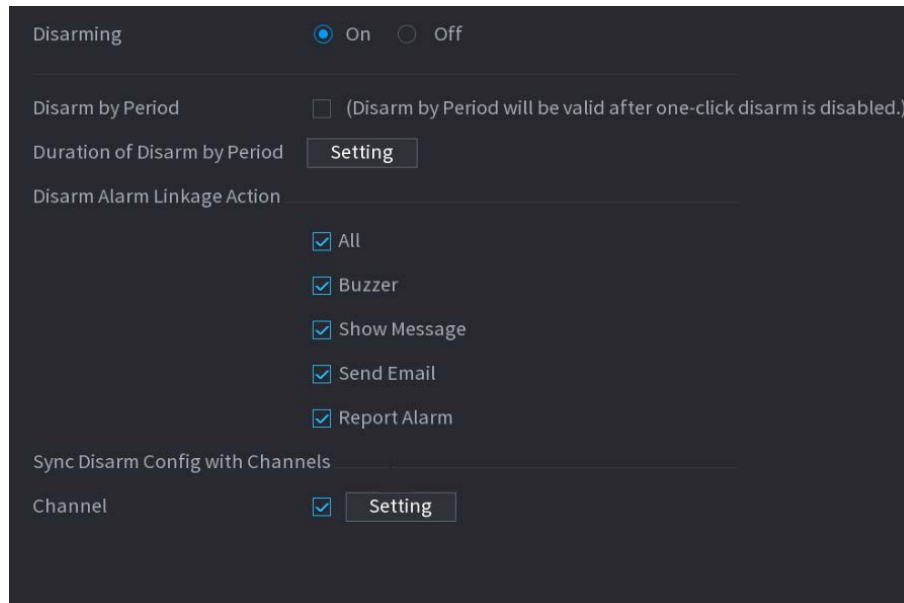

Step 3 (Optional) To enable scheduled disarming, click **Setting** next to **Duration of Disarm by Period**, and then set periods.



Scheduled disarming is only effective when **Disarming** is **Off**.

Figure 5-178 Scheduled disarming

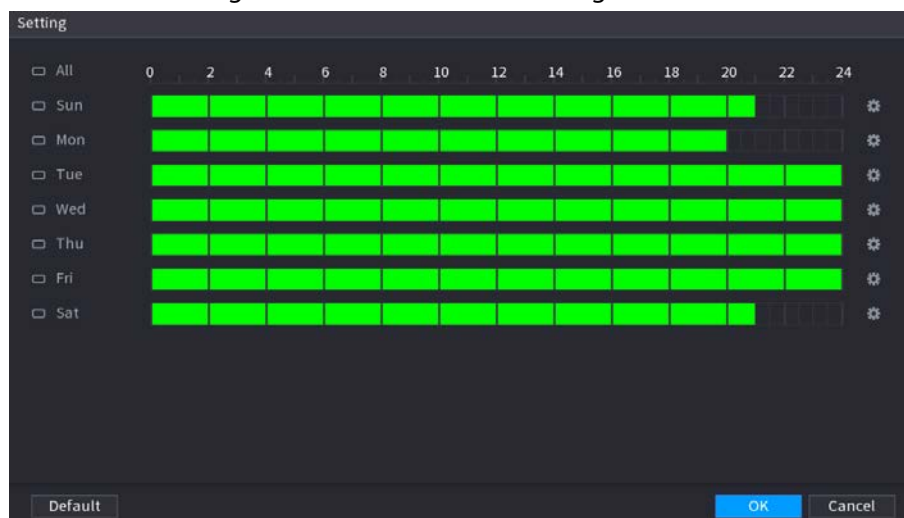

- Drag your mouse to select time blocks.
- Green blocks indicates that disarming is enabled.
- You can also click to set time periods. One day can have 6 periods at most.

Step 4 Select the alarm linkage actions to disarm.



All alarm linkage actions will be disarmed if you select **All**.

Step 5 To disarm remote channels, select the checkbox at **Channel**, and then click **Setting** to select channels.



This function is only effective when the connected camera supports one-click disarming.

Step 6 Click **Apply**.

5.11 Network

Configure the network settings to ensure the Device can communicate with other devices on the same LAN.

5.11.1 TCP/IP

Background Information

You can configure the settings for the Device such as IP address, DNS according to the networking plan.

Procedure

Step 1 Select **Main Menu > NETWORK > TCP/IP**.

Figure 5-179 TCP/IP

NIC Name	IP Address	Network ...	NIC Member	Modify	Unbind
NIC1	192.168.1.1	Single NIC	1		

IP Address: 192.168.1.1 Default Gateway: 192.168.1.1 MTU: 1500
MAC Address: 00:12:34:56:78:9A Subnet Mask: 255.255.255.0 Mode: Static

IP Version: DHCP

Preferred DNS:

Alternate DNS:

Default Card:



Virtual Host:

Step 2 Click to configure the NIC card, and then click **OK**.

Figure 5-180 TCP/IP

Table 5-50 TCP/IP parameters

Parameter	Description
Network Mode	<ul style="list-style-type: none"> • Single NIC: The current NIC card works independently. If the current NIC card is disconnected, the Device becomes offline. • Fault Tolerance: Two NIC cards share one IP address. Normally only one NIC card is working. When this card fails, the other NIC card will start working automatically to ensure the network connection. The Device is regarded as offline only when both NIC cards are disconnected. • Load Balance: Two NIC cards share one IP address and work at the same time to share the network load averagely. When one NIC card fails, the other card continues to work normally. The Device is regarded as offline only when both NIC cards are disconnected. <p> The Device with single Ethernet port does not support this function.</p>
NIC Member	<p>When the network mode is Fault Tolerance or Load Balance, you need to select the checkbox to bind NIC cards.</p> <p></p> <ul style="list-style-type: none"> • Make sure that at least two NIC cards are installed. • NIC cards using different ports such as optical port and electrical port cannot be bound together. • After binding NIC cards, you need to restart the Device to make the change effective.

Parameter	Description
IP Version	Select IPv4 or IPv6. Both versions are supported for access.
MAC Address	Displays the MAC address of the Device.
DHCP	<p>Enable the system to allocate a dynamic IP address to the Device. There is no need to set IP address manually.</p>  <ul style="list-style-type: none"> • If you want to manually configure the IP information, disable the DHCP function first. • If PPPoE connection is successful, the IP address, subnet mask, default gateway, and DHCP are not available for configuration.
IP Address	<p>Enter the IP address and configure the corresponding subnet mask and default gateway.</p>  <ul style="list-style-type: none"> • The IP address and default gateway must be on the same network segment. • Click Test to check whether the IP address is available.
Subnet Mask	
Default Gateway	
MTU	Displays the MTU value of the NIC card.

Step 3 On the **TCP/IP** page, configure the DNS server.



This step is compulsive if you want to use the domain service.

- Obtain DNS server automatically.
When there is DHCP server on the network, you can enable **DHCP** so that the Device can automatically obtain a dynamic IP address.
- Configure DNS server manually.
Select the IP version, and then enter the IP addresses of preferred and alternate DNS server.

Step 4 Select a NIC card as the default card.

Step 5 Click **Apply**.

5.11.2 Routing Table

Background Information

You can configure the routing table so that the system can automatically calculate the best path for data transmission.

Procedure

Step 1 Select **Main Menu > NETWORK > TCP/IP > Routing Table**.

Figure 5-181 Routing table

Auto Add

Manual Add

Destination Address: 0 0 0 0

Netmask: 0 0 0 0

Gateway: 0 0 0 0

Interface: NIC1

Custom Routing Table Info (0/8)

Destination Address	Netmask	Gateway	Interface	Delete

Step 2 Add the routing table.

- Auto add.
When you add a camera to the NVR and the IP address of the camera is not on the existing routing table, the system will add the routing information.
- Manual add.
Configure the parameters such as destination address, netmask, and gateway, and then click **Add**.



- ◇ The destination address and netmask must not be on the same LAN.
- ◇ The netmask must be valid and on the same LAN with the NIC card.
- ◇ You can configure up to eight pieces of routing information.

Step 3 Click **Apply**.

5.11.3 Port

Background Information

You can configure the maximum connection for accessing the Device from web, platform, mobile phone or other clients at the same time, and configure each port number.

Procedure

Step 1 Select **Main Menu > NETWORK > Port**.

Figure 5-182 Port

Max Connection	128	(0-128)
TCP Port	37777	(1025-65535)
UDP Port	37778	(1025-65535)
HTTP Port	80	(1-65535)
HTTPS Port	443	(1-65535)
RTSP Port	554	(1-65535)
NTP Server Port	123	(1-65535)
POS Port	38800	(1025-65535)
RTSP Format	rtsp://<Username>:<Password>@<IP Address>:<Port>/cam/realmonitor?channel=1&subtype=0 channel: Channel, 1-24; subtype: Stream Type, Main Stream 0, Sub Stream 1.	

Step 2 Configure the parameters.



The parameters except **Max Connection** take effect after the Device restarts.

Table 5-51 Port parameters

Parameter	Description
Max Connection	The allowable maximum clients accessing the Device at the same time, such as web client, platform, and mobile client.
TCP Port	Transmission control protocol port. Enter the value according to your actual situation.
UDP Port	User datagram protocol port. Enter the value according to your actual situation.
HTTP Port	The default value setting is 80. You can enter the value according to your actual situation. If you change the HTTP port number to, for example, 70, then you need to enter 70 after the IP address when logging in to the Device through the browser.
HTTPS Port	HTTPS communication port. The default value is 443. You can enter the value according to your actual situation.
RTSP Port	The default value is 554. You can enter the value according to your actual situation.
POS Port	POS data transmission port. The value range from 1 through 65535. The default value is 38800.

Step 3 Click **Apply**.

5.11.4 External Wi-Fi

The Device can be connected to wireless network with an external Wi-Fi module.

Prerequisites

Make sure that external Wi-Fi module is installed on the Device.

Background Information



This function is available on select models.

Procedure

Step 1 Select **Main Menu > NETWORK > Wi-Fi**.

Figure 5-183 Wi-Fi

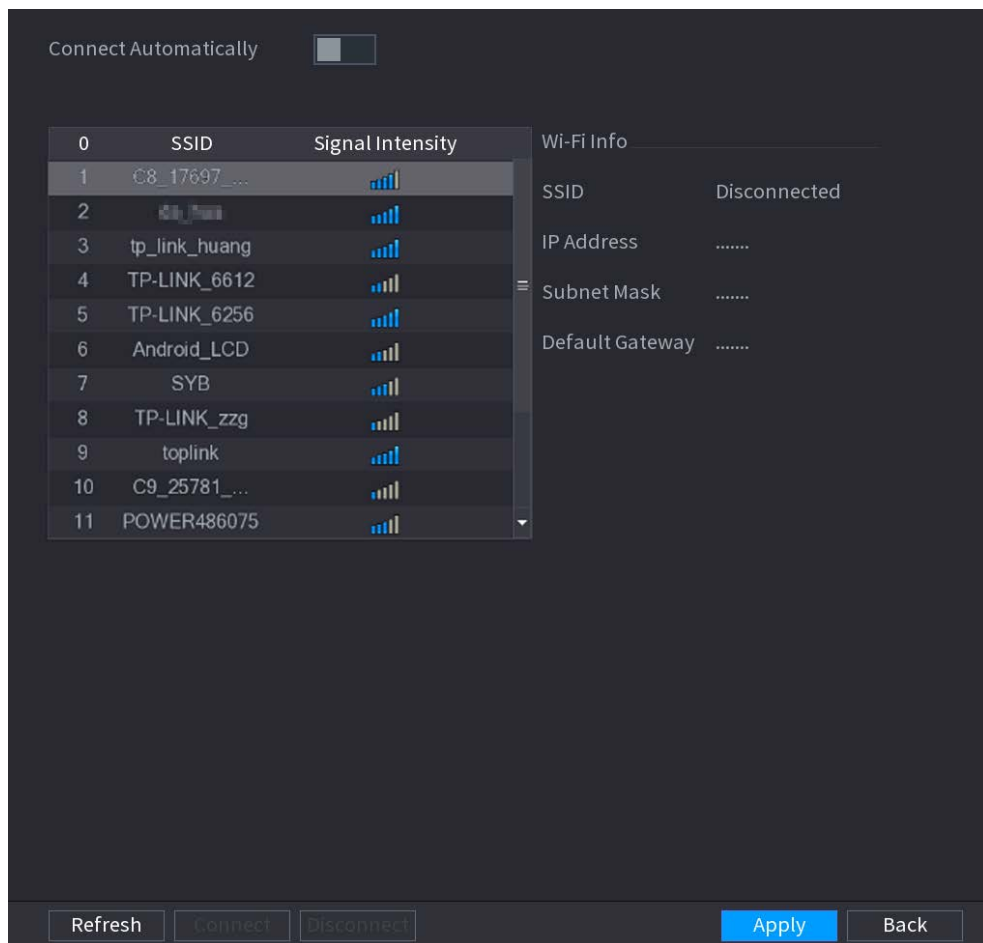

Step 2 Configure the parameters.

Table 5-52 Wi-Fi parameters

Parameter	Description
Connect Automatically	After the function is enabled, the NVR will connect to the nearest site that was previously successfully connected after the Device starts.
Refresh	Search for the sites again.
Disconnect	Disconnect the current connection.

Parameter	Description
Connect	Select an available site and then click Connect .

Step 3 Click **Apply**.



- After the connection is successful, a Wi-Fi connection signal flag appears in the upper-right corner of the live view page.
- The Wi-Fi module models currently supported are D-LINK, dongle and EW-7811UTC wireless cards.

5.11.5 Wi-Fi AP

Background Information

You can configure Wi-Fi parameters for the NVR to ensure that a wireless IPC can connect to the NVR through Wi-Fi AP.



This function requires the built-in Wi-Fi module in the Device.

5.11.5.1 General Settings

Background Information

You can configure SSID, encryption type, password and channel of the device.



- This function is supported on select wireless models.
- When the wireless IPC and NVR are matched, the pairing will be completed in 120 seconds after they are powered on.

Procedure

Step 1 Select **Main Menu > NETWORK > Wi-Fi AP > General**.

Figure 5-184 General settings

Step 2 Select **Wi-Fi** to enable Wi-Fi.

Step 3 Configure parameters.

Table 5-53 Parameters of general settings

Parameter	Description
SSID	Wi-Fi name for the device.
Hide SSID	Hide the Wi-Fi name.
Encryption Type	Select an encryption mode from WPA2 PSK and WPA PSK.
Password	Set the Wi-Fi password for the Device.
Select Channel	Select the channel for device communication.
Network Proxy	Enable the external network access through the Device for a wireless IPC.

Step 4 Click **Apply**.

5.11.5.2 Advanced Settings

Background Information



This function is supported on select wireless models.

You can configure IP address, subnet mask, default gateway, DHCP server of the Device.

Procedure

Step 1 Select **Main Menu > NETWORK > Wi-Fi AP > Advanced**.

Figure 5-185 Advanced settings

Step 2 Configure parameters.

Table 5-54 Parameters of advanced settings

Parameter	Description
IP Address	Set IP address, subnet mask and default gateway for the Wi-Fi of NVR. IP address and default gateway must be on the same network segment.
Subnet Mask	
Default Gateway	
Start IP	Set the start IP address and end IP address of the DHCP server.
End IP	
Preferred DNS	Set preferred and alternate DNS server address.
Alternate DNS	

Step 3 Click **Apply**.

5.11.6 3G/4G

Prerequisites

Make sure that 3G/4G module is installed on the device.

Background Information



This function is available on select models.

Procedure

Step 1 Select **Main Menu > NETWORK > 3G/4G**.

Figure 5-186 3G/4G

The page is divided into three main areas:

- Zone 1 displays a 3G/4G signal indication.
- Zone 2 displays 3G/4G module configuration information.
- Zone 3 displays the status information of the 3G/4G module.



Zone 2 displays the corresponding information when the 3G/4G module is connected, while Zone 1 and Zone 3 will only display the corresponding content when the 3G/4G is enabled.

Step 2 Configure parameters.

Table 5-55 3G/4G parameters

Parameter	Description
NIC Name	Select a NIC name.

Parameter	Description
Network Type.	Select a 3G/4G network type to distinguish between 3G/4G modules from different vendors.
APN, Dial-up No.	Main parameters of PPP dial.
Authentication Type	Select PAP, CHAP or NO_AUTH. NO_AUTH represents no authentication for 3G/4G.

Step 3 Click **Apply**.

5.11.7 Cellular Network

Connect the Device to mobile network and view network status and traffic of the cellular network.

Prerequisites

A SIM card is inserted in the recorder.

Background Information



This function is available on select models.

Procedure

Step 1 Select **Main Menu > NETWORK > Cellular Network > Cellular Network**.

Step 2 Enable cellular network and configure parameters.

Figure 5-187 Configuring cellular network

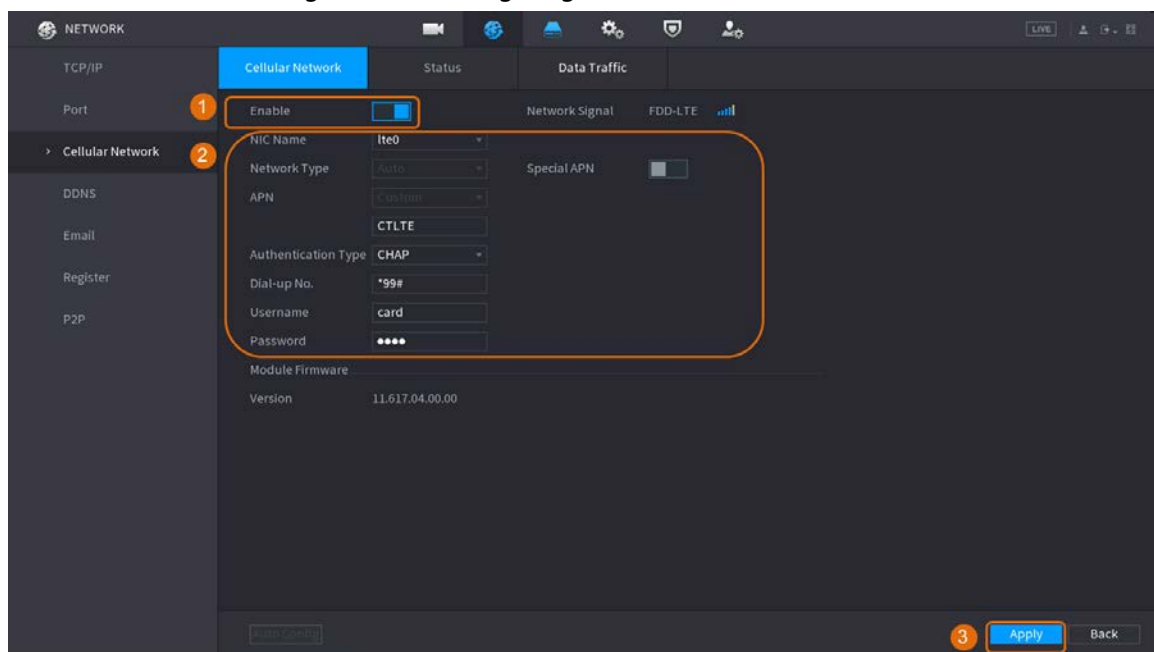

Table 5-56 4G cellular network parameters

Parameter	Description
NIC Name	Select a NIC.
Network Type	Select a network from the SIM card provider.

Parameter	Description
APN, Dial-up No.	The two main parameters of PPP dial-up connection.
Authentication Type	Select PAP , CHAP or NO-AUTH .
Username	The username for dial-up connection.
Password	The password for dial-up connection.

Step 3 Click **Apply**.

Related Operations

- View network status.
Click the **Status** tab to check cellular network status such as IP address, SIM card status and dial-up status.

Figure 5-188 Network status

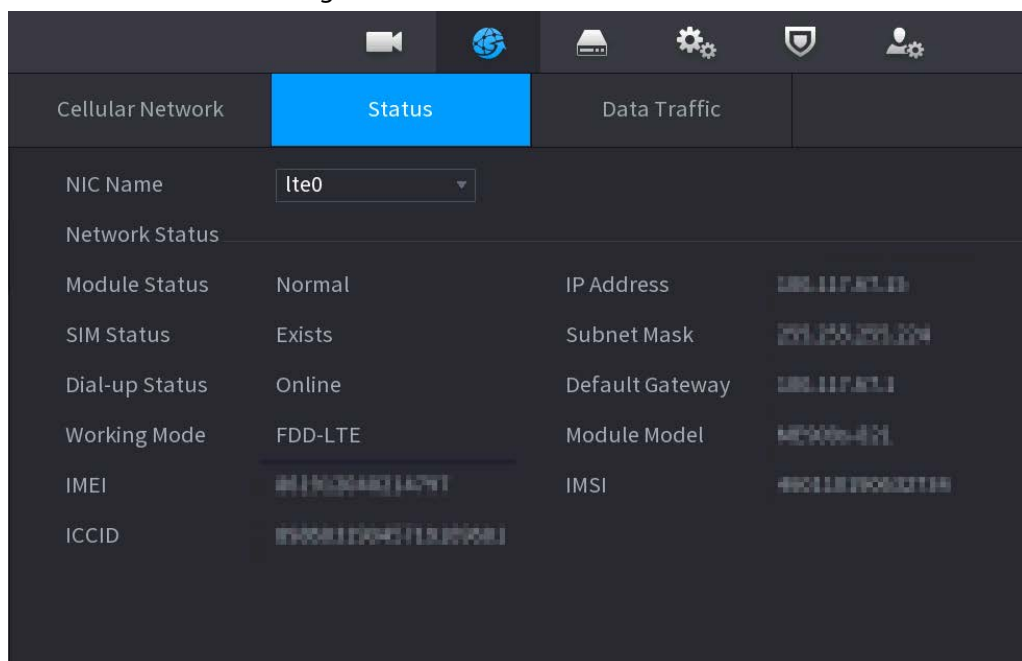

- View data traffic.
Click the **Data Traffic** tab to view the daily and monthly data usage.

Figure 5-189 Cellular data usage

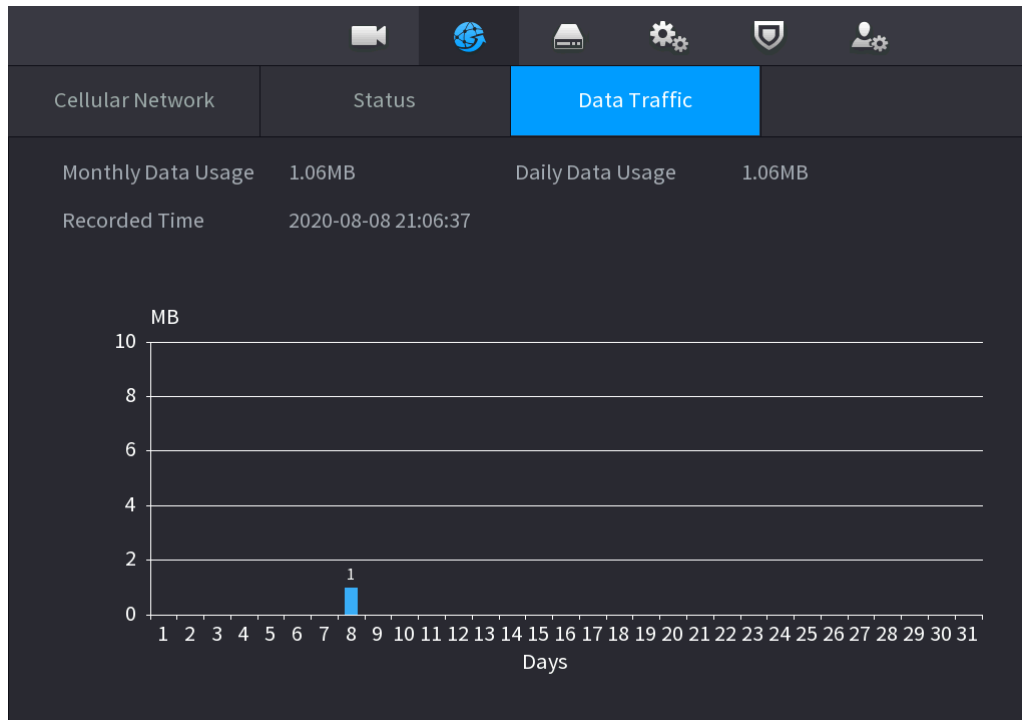

5.11.8 Repeater

The Device supports settings for the wireless repeater IPC to extend video transmission distance and range.

Prerequisites

- The Device has the built-in Wi-Fi module.
- The IPC has wireless repeater module.

Background Information



This function is available on select models.

Procedure

- Step 1 Power on the NVR and wireless repeater IPC, and connect all IPCs to the NVR through Wi-Fi.
- Step 2 Select **Main Menu** > **NETWORK** > **REPEATER**.



- Green connection line represents the successful connection between channel and wireless IPC.
- Auto cascade: After selecting auto cascade, the IPC can cascade to NVR automatically.

Figure 5-190 Repeater



Step 3 Select **Manual Cascade**.



You can use manual cascade when there are at least two IPCs on the network.

Figure 5-191 Manual cascade

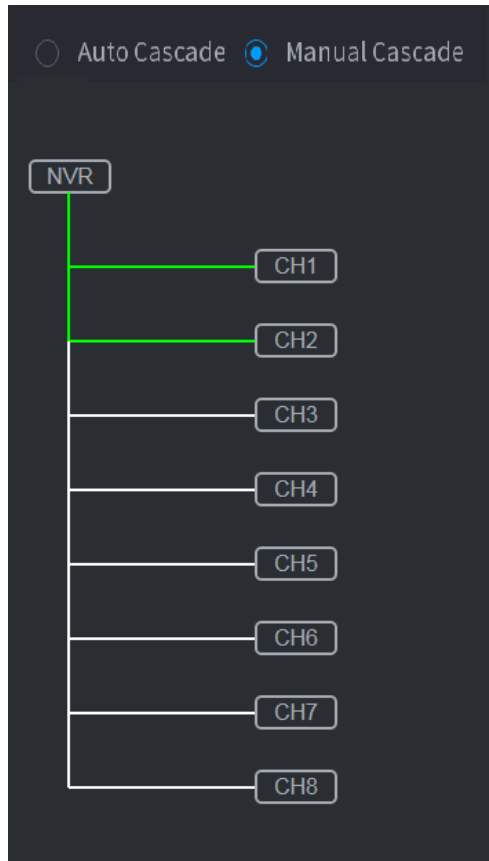

Step 4 Click and select the channel to be added.

Figure 5-192 Added channel

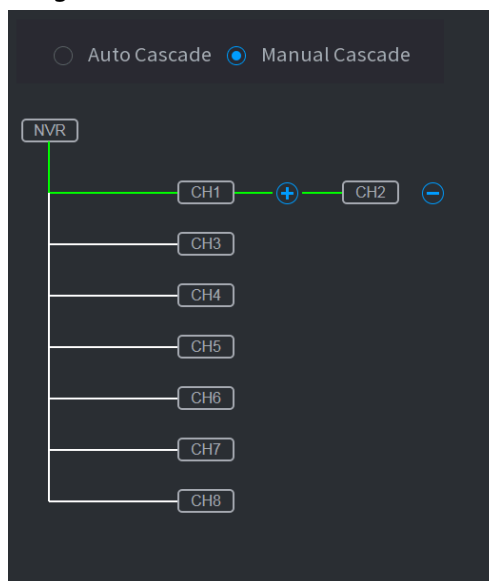

Step 5 Click **Apply**.

5.11.9 PPPoE

PPPoE is another way for the Device to access the network. You can establish network connection by configuring PPPoE settings to give the Device a dynamic IP address on the WAN.

Prerequisites

To use this function, firstly you need to obtain the username and password from the Internet Service Provider.

Procedure

Step 1 Select **Main Menu > NETWORK > PPPoE**.

Figure 5-193 PPPoE

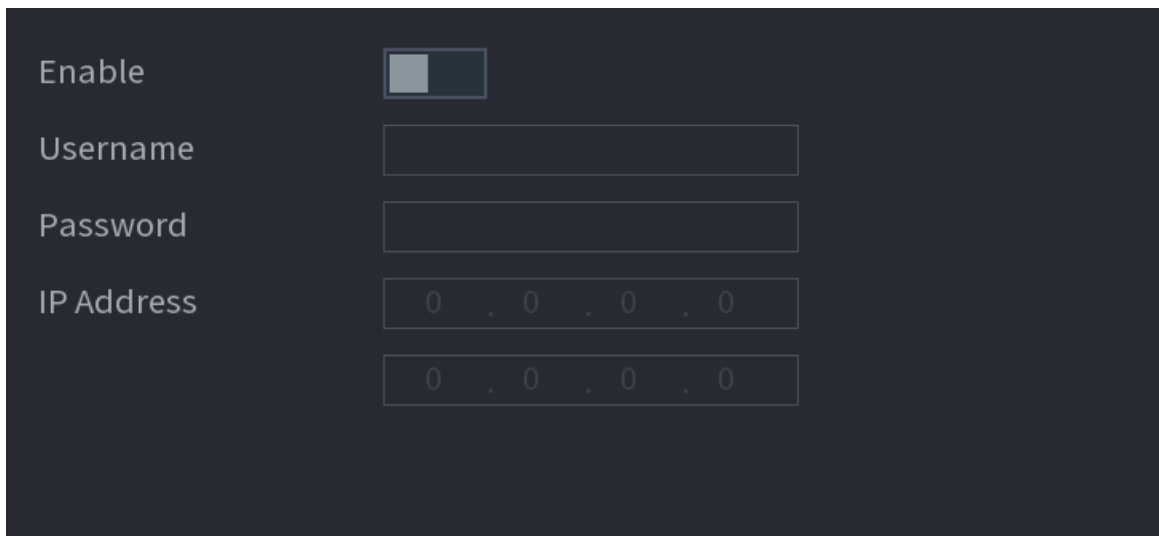

Step 2 Enable the PPPoE function.

Step 3 Enter the username and password provided by the Internet Service Provider.

Step 4 Click **Apply**.

The IP address appears on the PPPoE page. You can use this IP address to access the Device.



When the PPPoE function is enabled, the IP address on the **TCP/IP** page cannot be modified.

5.11.10 DDNS

When the IP address of the Device changes frequently, the DDNS function can dynamically refresh the correspondence between the domain on DNS and the IP address. You can access the Device by using the domain.

Prerequisites

Check the type of DDNS that the Device supports and then log in to the website provided by the DDNS service provider to register domain and other information.



After registration, you can log in to the DDNS website to view the information of all the connected devices under the registered account.

Procedure

Step 1 Select **Main Menu > NETWORK > DDNS**.

Figure 5-194 DDNS

Enable

After enabling DDNS function, third-party server may collect your device info.

Type: NO-IP DDNS

Server Address: dynupdate.no-ip.com

Domain Name:

Username:

Password:

Interval: 1440 min.

Step 2 Enable DDNS and then configure the parameters.



After you enable DDNS function, the third-party server might collect your device information.

Table 5-57 DDNS parameters

Parameter	Description
Type	Displays the type and address of DDNS service provider.
Server Address	<ul style="list-style-type: none"> For Dyndns DDNS, the default address is members.dyndns.org. For NO-IP DDNS, the default address is dynupdate.no-ip.com. For CN99 DDNS, the default address is members.3322.org.
Domain Name	Enter the domain name that you have registered on the website of DDNS service provider.
Username	Enter the username and password obtained from DDNS service provider. You need to register the username, password and other information on the website of DDNS service provider.
Password	
Interval	Enter the interval at which you want to update the DDNS.

Step 3 Click **Apply**.

Enter the domain name in the browser on your computer, and then press the Enter key. If the web interface of the Device is displayed, the configuration is successful. If not, the configuration failed.

5.11.11 UPnP

You can map the relationship between the LAN and the WAN to access the Device on the LAN through the IP address on the WAN.

5.11.11.1 Configuring Router

Procedure

- Step 1 Log in to the router to set the WAN port to enable the IP address to connect into the WAN.
- Step 2 Enable the UPnP function on the router.
- Step 3 Connect the Device with the LAN port on the router to connect into the LAN.
- Step 4 Select **Main Menu > NETWORK > TCP/IP**, configure the IP address into the router IP address range, or enable the DHCP function to obtain an IP address automatically.

5.11.11.2 Configuring UPnP

Procedure

- Step 1 Select **Main Menu > NETWORK > UPnP**.





Figure 5-195 UPnP

6	Service Name	Protocol	Internal...	Externa...	Modify
1	HTTP	TCP	80	80	
2	TCP	TCP	37777	37777	
3	UDP	UDP	37778	37778	
4	RTSP	UDP	554	554	
5	RTSP	TCP	554	554	
6	HTTPS	TCP	443	443	

- Step 2 Configure the settings for the UPnP parameters.

Table 5-58 UPnP parameters

Parameter	Description
Port Mapping	Enable the UPnP function.
Status	Indicates the status of UPnP function. <ul style="list-style-type: none"> ● Offline: Failed. ● Online: Succeeded.

Parameter	Description
LAN IP	Enter IP address of router on the LAN.  After mapping succeeded, the system obtains IP address automatically.
WAN IP	Enter IP address of router on the WAN.  After mapping succeeded, the system obtains IP address automatically.
Port Mapping List	The settings on port mapping list correspond to the UPnP port mapping list on the router. <ul style="list-style-type: none"> • Service Name: Name of network server. • Protocol: Type of protocol. • Internal Port: Internal port that is mapped on the Device. • External Port: External port that is mapped on the router.  <ul style="list-style-type: none"> • To avoid the conflict, when setting the external port, try to use the ports from 1024 through 5000 and avoid popular ports from 1 through 255 and system ports from 256 through 1023. • When there are several devices on the LAN, properly arrange the ports mapping relations to avoid mapping to the same external port. • When establishing a mapping relationship, ensure the mapping ports are not occupied or limited. • The internal and external ports of TCP and UDP must be the same and cannot be modified. • Click  to modify the external port.

Step 3 Click **Apply** to complete the settings.

In the browser, enter `http://WAN IP: External IP port`. You can visit the Device on the LAN.

5.11.12 Email

Background Information

You can configure the email settings to enable the system to send the email as a notification when an alarm event occurs.

Procedure

Step 1 Select **Main Menu > NETWORK > Email**.

Figure 5-196 Email

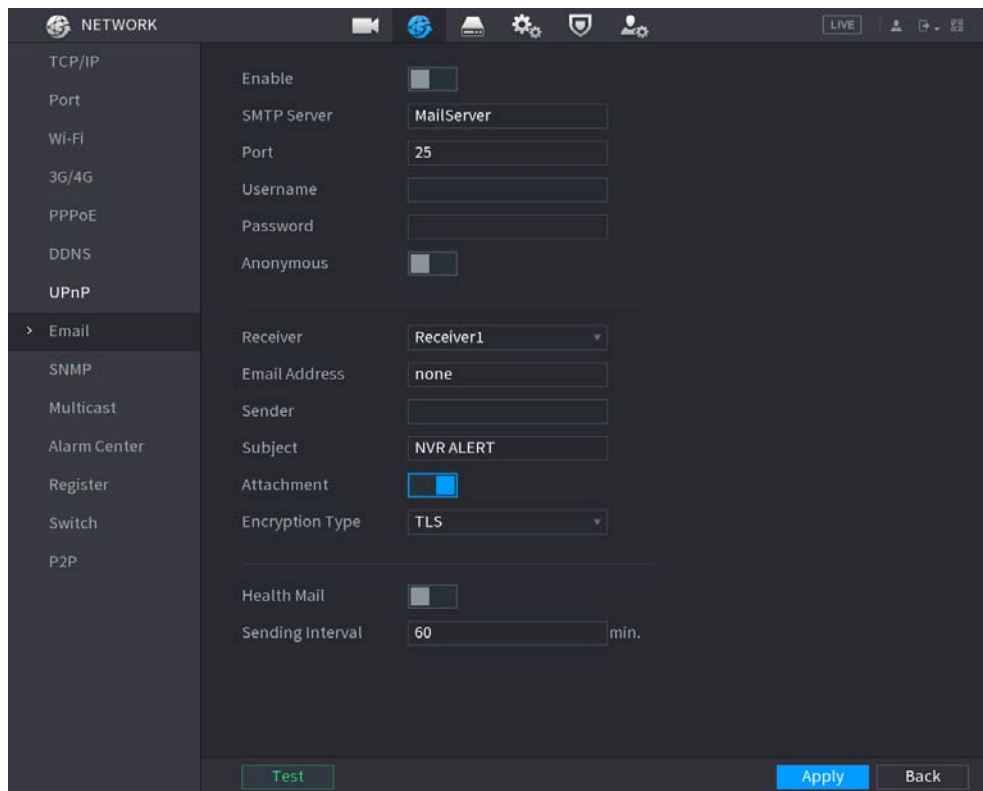

Step 2 Click to enable the function.

Step 3 Configure the email parameters.

Table 5-59 Email parameters

Parameter	Description
SMTP Server	Enter the address of SMTP server of sender's email account.
Port	Enter the port of SMTP server. The default value is 25.
Username	Enter the username and password of sender's email account.
Password	
Anonymous	Enable anonymous login.
Receiver	Select the receiver to receive the notification. You can select up to three receivers.
Email Address	Enter the email address of mail receivers.
Sender	Enter the sender's email address. You can enter up to three senders separated by comma.
Subject	Enter the email subject. You can enter Chinese, English and numerals with the length limited to 64 characters.
Attachment	Enable the attachment function. When there is an alarm event, the system can attach snapshots as an attachment to the email.
Encryption Type	Select the encryption type from NONE , SSL , or TLS .  For SMTP server, the default encryption type is TLS .

Parameter	Description
Interval (Sec.)	Set the interval at which the system sends an email for the same type of alarm event to avoid excessive pileup of emails caused by frequent alarm events. The value ranges from 0 to 3600. 0 means that there is no interval.
Health Mail	Enable the health test function. The system can send a test email to check the connection.
Sending Interval	Set the interval at which the system sends a health test email. The value ranges from 30 to 1440. 0 means that there is no interval.
Test	Click Test to test the email sending function. If the configuration is correct, the receiver's email account will receive the email.  Before testing, click Apply to save the settings.

Step 4 Click **Apply**.

5.11.13 SNMP

You can connect the Device with some software such as MIB Builder and MG-SOFT MIB Browser to manage and control the Device from the software.

Prerequisites

- Install the software that can manage and control the SNMP, such as MIB Builder and MG-SOFT MIB Browser
- Obtain the MIB files that correspond to the current version from the technical support.



This function is available on select models.

Procedure

Step 1 Select **Main Menu > NETWORK > SNMP**.

Figure 5-197 SNMP

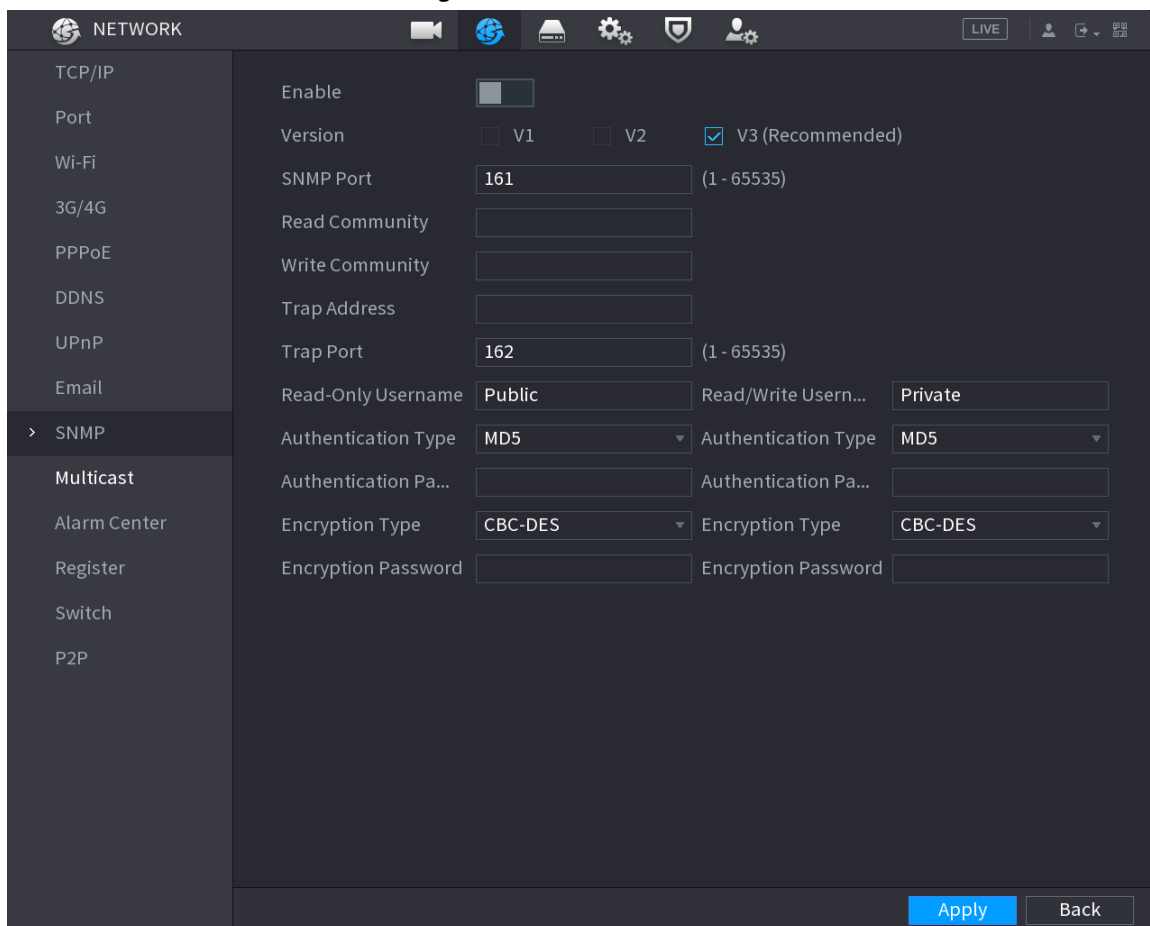

Step 2 Click  to enable the function.

Step 3 Configure the parameters.

Table 5-60 SNMP parameters

Parameter	Description
Version	Select the checkbox of SNMP version that you are using.  The default version is V3 . There is a risk if you use V1 or V2.
SNMP Port	Enter the monitoring port on the agent program.
Read Community	Enter the read and write strings supported by the agent program.
Write Community	
Trap Address	Enter the destination address for the agent program to send the Trap information.
Trap Port	Enter the destination port for the agent program to send the Trap information.
Read-Only Username	Enter the username that is allowed to access the Device and has the read-only permission.
Read/Write Username	Enter the username that is allowed to access the Device and has the read and write permission.
Authentication Type	Select MD5 or SHA. The system recognizes the type automatically.

Parameter	Description
Authentication Password	Enter the password for authentication. The password should be no less than eight characters.
Encryption Type	Select an encryption type. The default setting is CBC-DES.
Encryption Password	Enter the encryption password.

- Step 4** Click **Apply**.
- Step 5** Compile the two MIB files by MIB Builder.
- Step 6** Run MG-SOFT MIB Browser to load in the module from compilation.
- Step 7** On the MG-SOFT MIB Browser, enter the device IP that you want to manage, and then select the version number to query.
- Step 8** On the MG-SOFT MIB Browser, unfold the tree-structured directory to obtain the configurations of the Device, such as the channels quantity and software version.

5.11.14 Multicast

Background Information

When you access the Device from the network to view the video, if the access is exceeded, the video will not display. You can use the multicast function to group the IP to solve the problem.

Procedure

- Step 1** Select **Main Menu > NETWORK > Multicast**.

Figure 5-198 Multicast

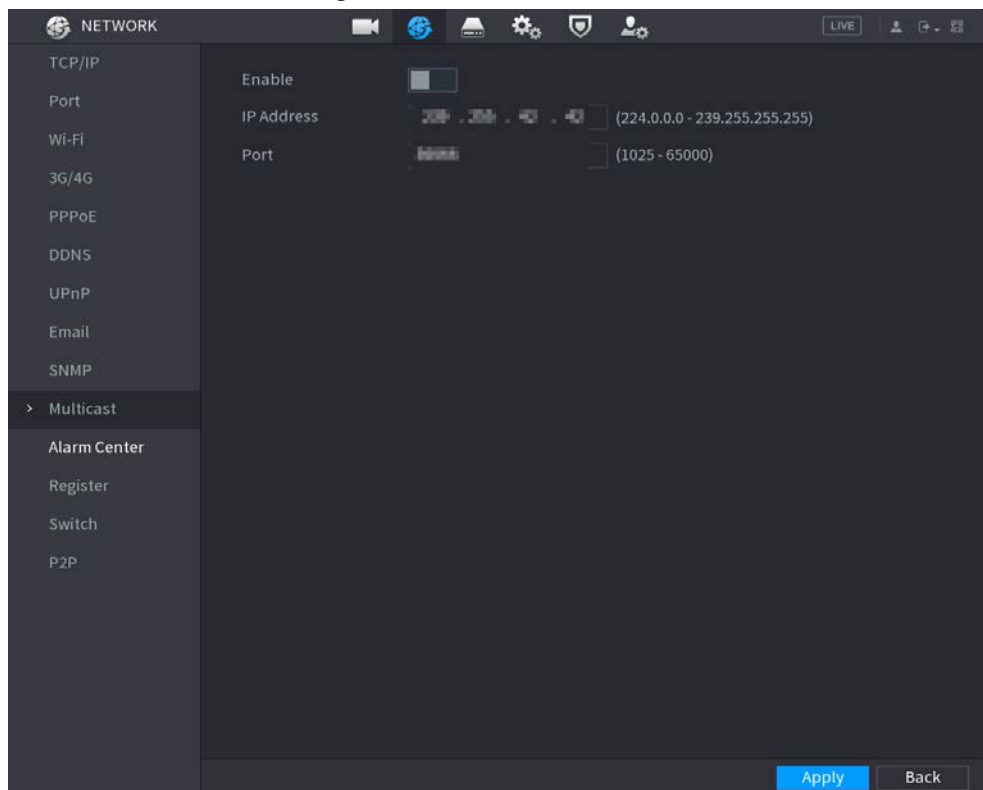

- Step 2** Configure the parameters.

Table 5-61 Multicast parameters

Parameter	Description
Enable	Enable the multicast function.
IP Address	Enter the IP address that you want to use as the multicast IP. The IP address ranges from 224.0.0.0 through 239.255.255.255.
Port	Enter the port for the multicast. The port ranges from 1025 through 65000.

Step 3 Click **Apply**.

You can log in to the web interface via multicast.

On the web login page, on the **Type** list, select **Multicast**. The web will automatically obtain the multicast IP address and join the multicast group. Then you can view the video through multicast function.

5.11.15 Alarm Center

Background Information

You can configure the alarm center server to receive the uploaded alarm information.

Procedure

Step 1 Select **Main Menu > NETWORK > Alarm Center**.

Figure 5-199 Alarm center

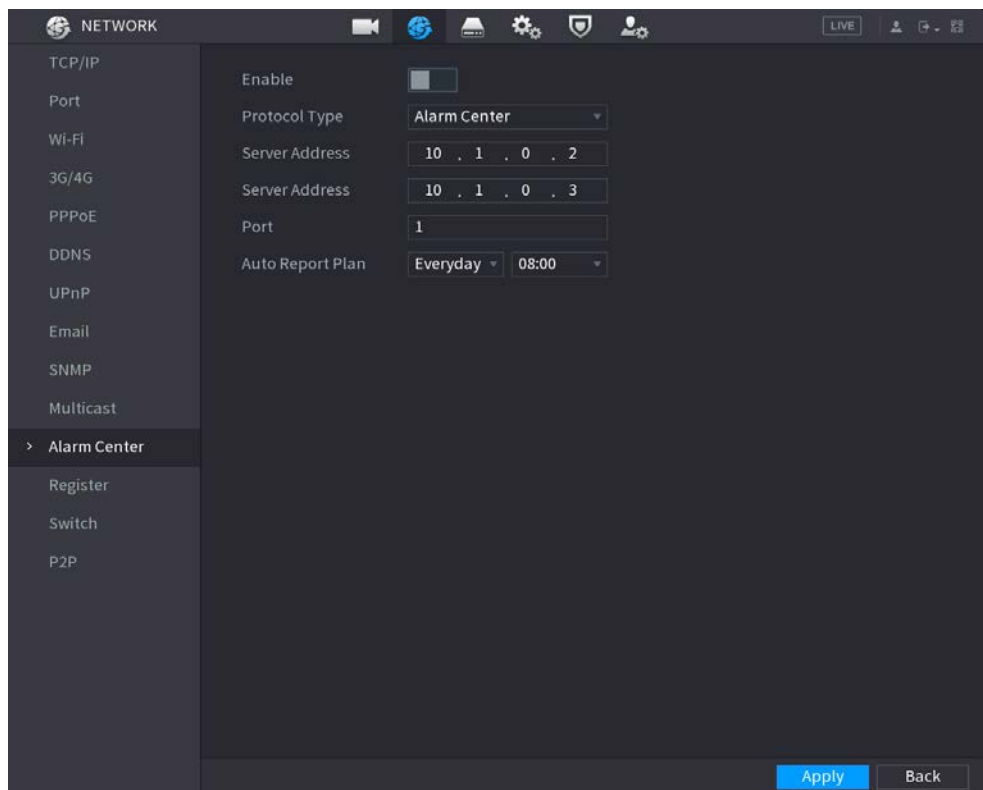

Step 2 Click to enable the function.

Step 3 Configure the parameters.

Table 5-62 Alarm center parameters

Parameter	Description
Protocol Type	Select a protocol type.
Server Address	The IP address and communication port of the PC installed with alarm client.
Port	
Auto Report Plan	Select time cycle and specific time for uploading alarm.

Step 4 Click **Apply**.

5.11.16 Register

You can register the Device into the specified proxy server which acts as the transit to enable the client software to access the Device

Prerequisites

- The proxy server has been deployed.
- The Device, the proxy server and the device running the client software are on the same network.

Procedure

Step 1 Select **Main Menu > NETWORK > Register**.

Figure 5-200 Register

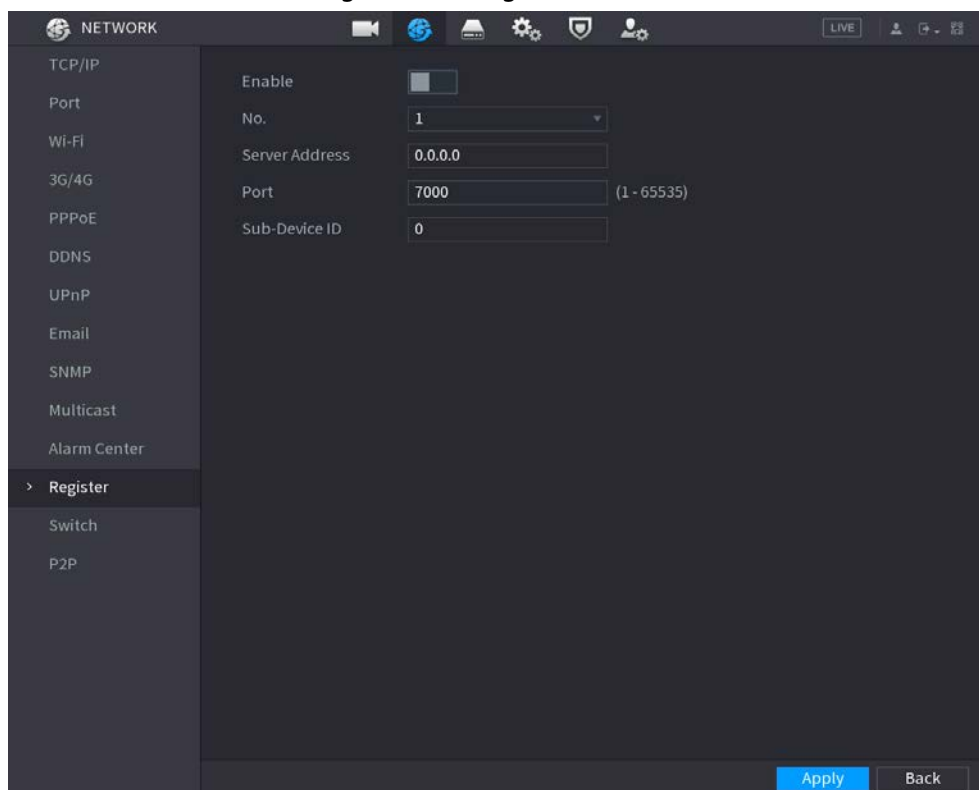

Step 2 Click  to enable the function.

Step 3 Configure the parameters.

Table 5-63 Register parameters

Function	Description
Server Address	Enter the IP address or domain name of the server that you want to register to.
Port	Enter the port of the server.
Sub-Device ID	Enter the ID allocated by the server.

Step 4 Click **Apply**.

5.11.17 Switch

Background Information

After setting **Switch**, when an IPC is connected to the PoE port, the system automatically assigns the IP address to the IPC according to the defined IP segment, and the NVR will automatically connect to the IPC.



- Only models with PoE ports support this function.
- Do not connect the PoE port with a switch, otherwise it will cause connection failure.
- This function is enabled by default, and the IP segment start from 10.1.1.1. We recommend you use the default setting.
- When connecting to a third-party IPC, make sure that the IPC supports ONVIF protocol and DHCP is enabled.

Procedure

Step 1 Select **Main Menu > NETWORK > Switch**.

Figure 5-201 Switch

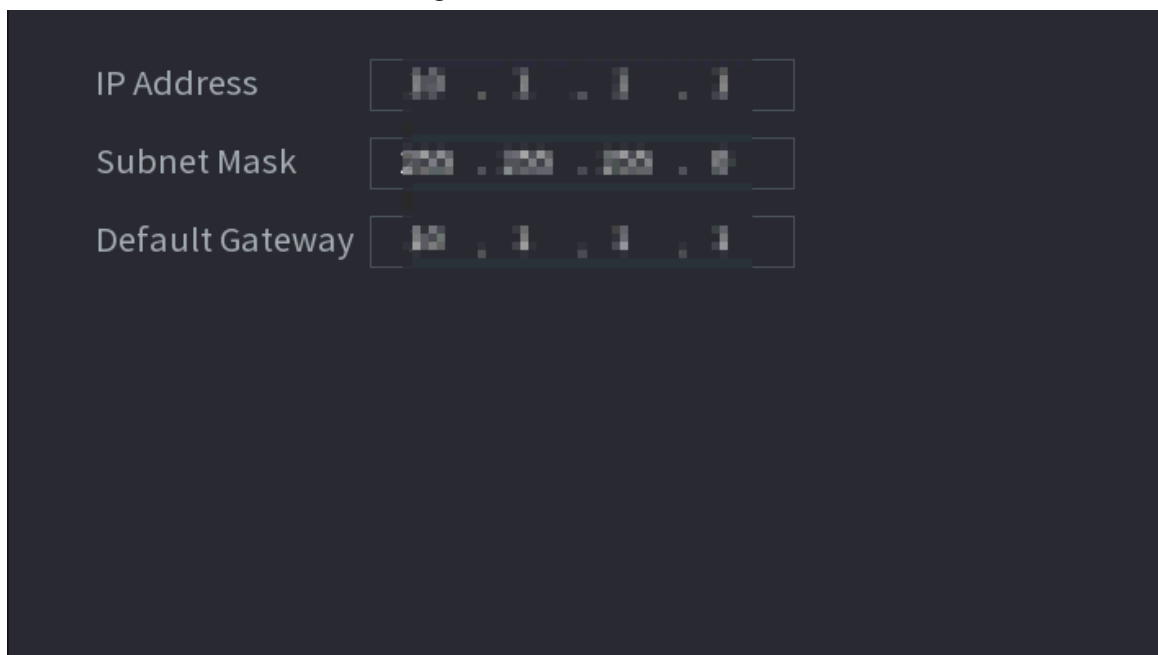

Step 2 Configure IP address, subnet mask, and default gateway..



Do not set the IP address to the same network segment with the NVR. We recommend you use the default setting.

Step 3 Click **Apply**.

Related Operations



When connecting IP camera to PoE port, if all the channels are occupied, the system prompts you whether to take place of one channel.

Table 5-64 PoE operation

PoE operation	Description
Connect to PoE port	<p>When an IPC is connected to the PoE port, the system automatically assigns the IP address to the IPC according to the set IP segment. The NVR will try the method of arp ping to assign the IP address. If DHCP is enabled on the NVR, the NVR will use DHCP to assign the IP address.</p> <ul style="list-style-type: none"> When IP address is successfully set, the system will broadcast through the switch function. If there is a response from the IPC, it means the connection is successful, and the NVR will log in to the IPC. You can find the corresponding channel occupied and there is a PoE icon at the upper-left corner. You can also view PoE status such as channel number and PoE port number on the Added Device list in Main Menu > CAMERA > Camera List.
Disconnect PoE port	When an IPC is disconnected from PoE port, you will find the information of Failed to find network host on the live channel window.
PoE connection mapping	The PoE ports are bound to corresponding channels. When an IPC is connected to PoE port 1, the corresponding channel is Channel 1.

5.11.18 P2P

P2P is a kind of convenient private network penetration technology. Instead of applying for dynamic domain name, mapping ports or deploying transit server, you can add NVR devices to the app for remote management.

Procedure

Step 1 Select **Main Menu > NETWORK > P2P**.

Figure 5-202 P2P

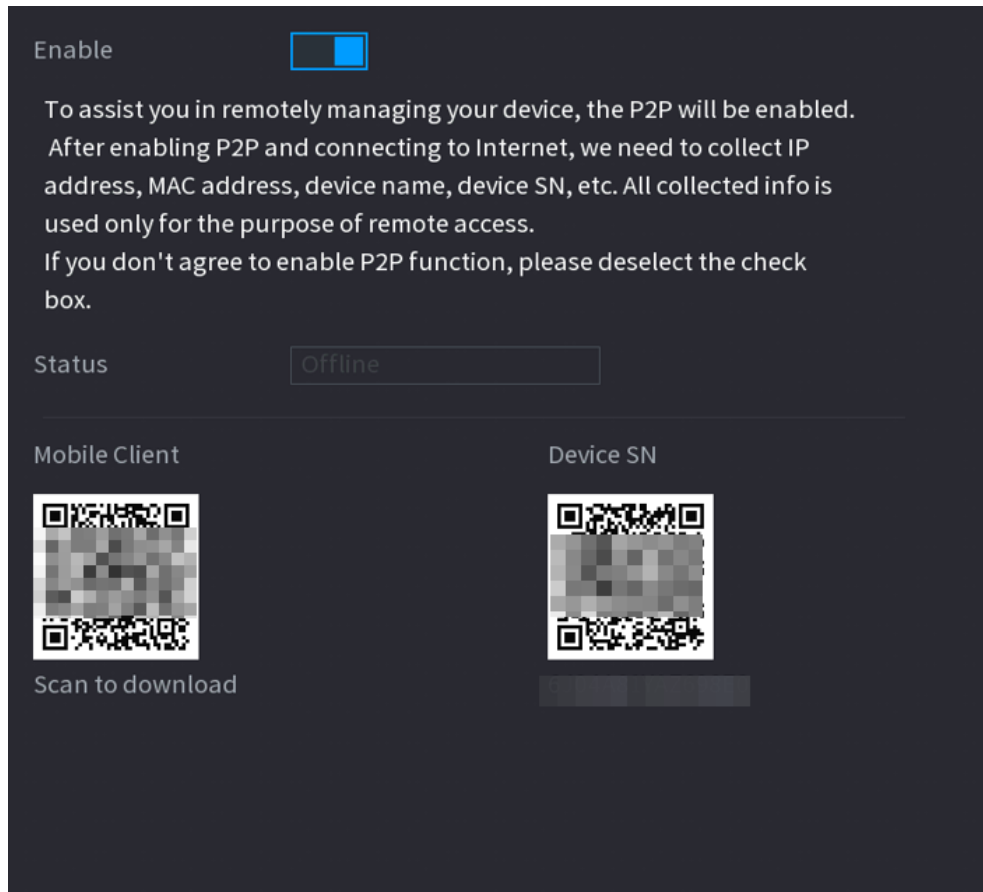

Step 2 Enable the P2P function.



After you enable the P2P function and connect to the Internet, the system will collect the information such as email address and MAC address for remote access.

Step 3 Click **Apply**.

The P2P function is enabled. You can use your phone to scan the QR code under **Mobile Client** to download and install the mobile client. After that, you can use the mobile client to scan the QR code under **Device SN** to add the Device for remote management. For details on the app operation, see the user's manual of the app.

5.12 Storage

You can manage the storage resources (such as record file) and storage space. So that it is easy for you to use and enhance storage space usage.

5.12.1 Basic

Background Information

You can set basic storage parameters.

Procedure

Step 1 Select **Main Menu > STORAGE > Basic**.

Figure 5-203 Basic storage

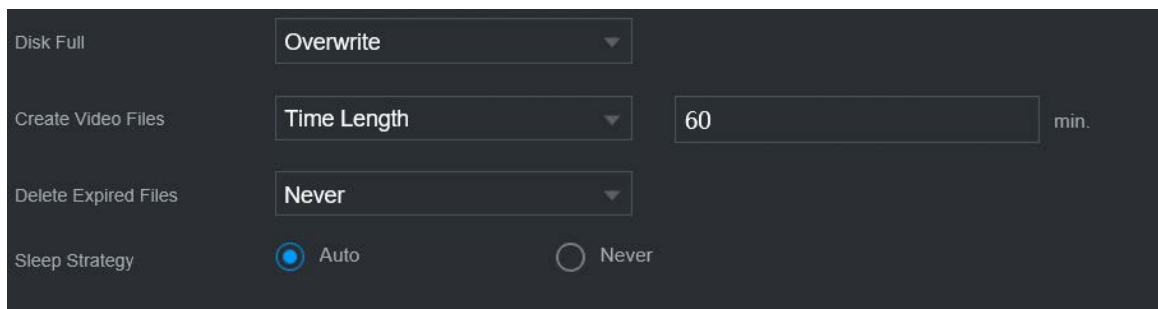

Step 2 Set parameters.

Table 5-65 Basic storage parameters

Parameter	Description
Disk Full	Configure the storage strategy to be used when no more storage space is available <ul style="list-style-type: none"> • Stop: Stop recording. • Overwrite: The newest files overwrite the oldest ones.
Create Video Files	Configure the time length and file length for each recorded video.
Delete Expired Files	Configure whether to delete the old files. <ul style="list-style-type: none"> • Select Auto and then configure how long you want to keep the old files. • Select Never if you do not want to use this function.  Deleted files cannot be recovered.
Sleep Strategy	<ul style="list-style-type: none"> • Auto: The system sleeps automatically after idling for a period of time. • Never: The system keeps running all the time.

Step 3 Click **Apply**.

5.12.2 Disk Manager

Select **Main Menu > STORAGE > Disk Manager**, and then you can set HDD properties and format HDD.

Figure 5-204 Disk manager

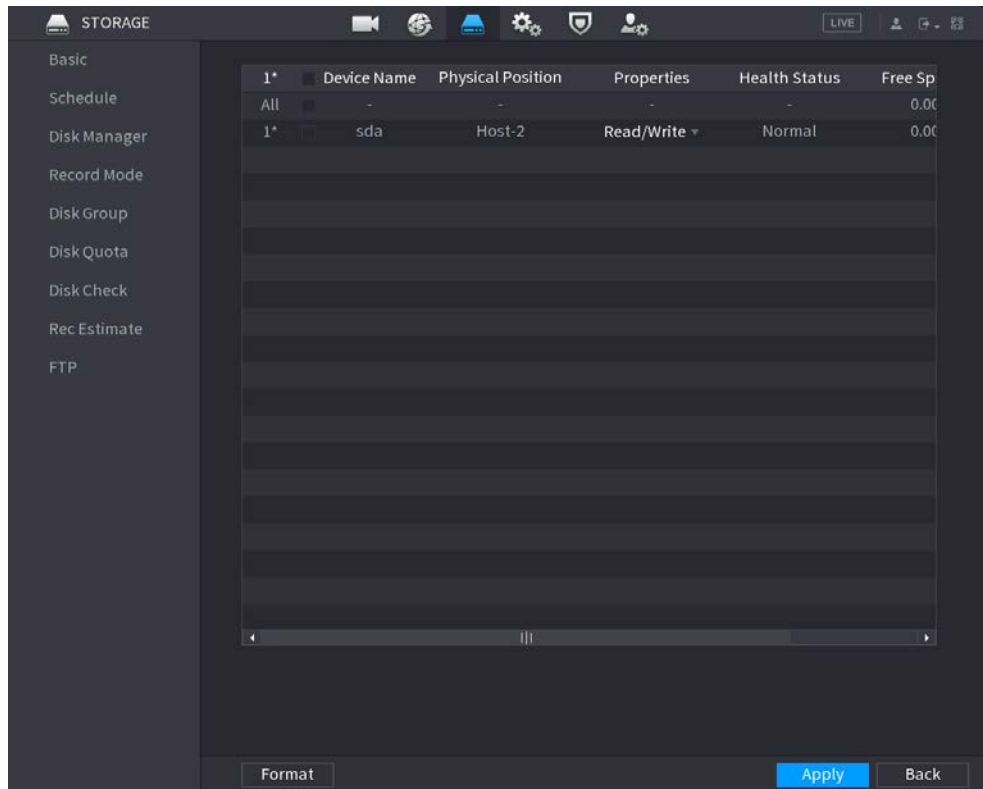

View HDD Information

You can view the physical position, properties, status and storage capacity of each HDD.

Configure HDD Properties

In the **Properties** column, you can set read and write, read-only and redundant HDD.



When there are two or more HDDs installed on the Device, you can set one HDD as redundant disk to back up recorded files.

Format HDD

Select an HDD, click **Format**, and then follow the on-screen prompts to format the HDD.



- Formatting will erase all data in the HDD, proceed with caution.
- You can select whether to erase the HDD database. If the HDD database is erased, the AI search data and the uploaded audio files will be deleted.

5.12.3 RAID

RAID (redundant array of independent disks) is a data storage virtualization technology that combines multiple physical HDD components into a single logical unit for the purposes of data redundancy, performance improvement, or both.



RAID function is available on select models.

Table 5-66 Disk quantity for different RAID types

RAID type	Required disk quantity
RAID 0	At least 2.
RAID 1	Only 2.
RAID 5	At least 3. We recommend using 4 disks to 6 disks.
RAID 6	At least 4.
RAID 10	

5.12.3.1 Creating RAID

RAID has different levels, such as RAID 5 and RAID 6. Each level has different data protection, data availability, and performance grade. You can create different types of RAID as needed.

Background Information



When you create RAID, the disks in the RAID group will be formatted. Back up data in time.

You can create different types of RAID as needed.

Procedure

Step 1 Select **Main Menu > STORAGE > RAID > RAID.**

Figure 5-205 RAID

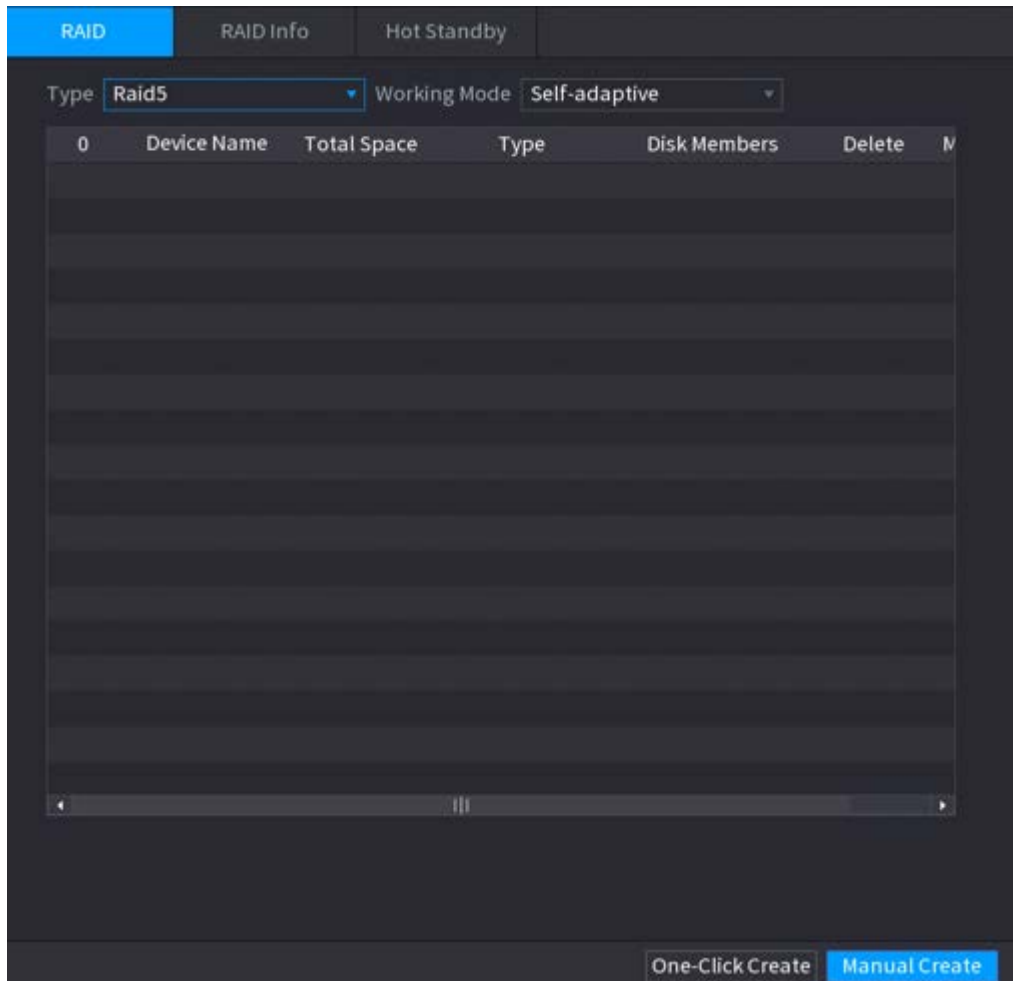

Step 2 Select RAID type and working mode.

The working mode determines how the system allocate resources.

- **Self-Adaptive:** Automatically adjust the RAID synchronization speed according to the business status.
 - ◇ When there is no business running, synchronization is performed at a high speed.
 - ◇ When there is business running, synchronization is performed at a low speed.
- **Sync First:** Resource priority is assigned to RAID synchronization.
- **Business First:** Resource priority is assigned to business operations.
- **Balance:** Resource is evenly distributed to RAID synchronization and business operations.

Step 3 Create RAID.



- Automatic creation.
Select disks, and then click **Create RAID**. The system will create RAID 5 automatically.



Automatic creation of RAID is available only when the RAID type is **Raid5**.

- Manual creation.
Select disks, click **Create Manually** and then follow the on-screen instructions to create RAID.

Related Operations

- Change working mode.
Click  to change the working mode of the RAID group.
- Delete RAID.
Click  to delete the RAID group.



When you delete a RAID group, the disks in the RAID group will be formatted.

5.12.3.2 Viewing RAID Information

Select **Main Menu > STORAGE > RAID > RAID Info**. You can view the RAID information, including type, disk space, hot spare, and status.

5.12.3.3 Creating Hot Spare Disk



Background Information

You can create a hot spare disk. When a disk of the RAID group malfunctions, the hot spare disk can replace the malfunctioning disk.

Procedure

Step 1 Select **Main Menu > STORAGE > RAID > Hotspare Disk**.

Figure 5-206 Hotspare disk

RAID		RAID Info		Hotspare Disk		
3	Name	Capacity	Type	RAID Name	Edit	Delete
1	Disk_1	931.46 GB	General HDD	-		-
2	Disk_2	2.72 TB	General HDD	-		-
3	Disk_3	2.72 TB	General HDD	-		-

Step 2 Click .

Figure 5-207 Local hotspare

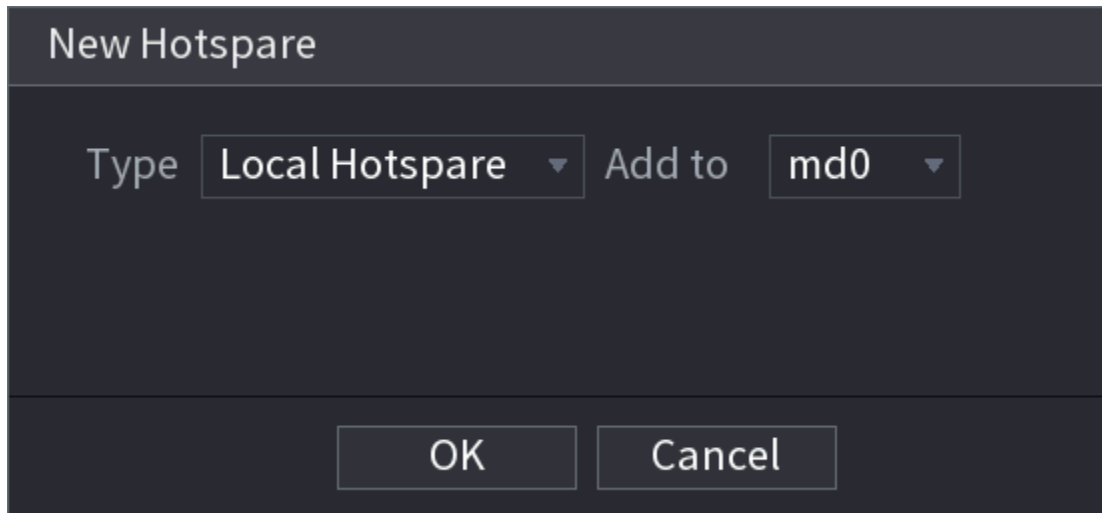
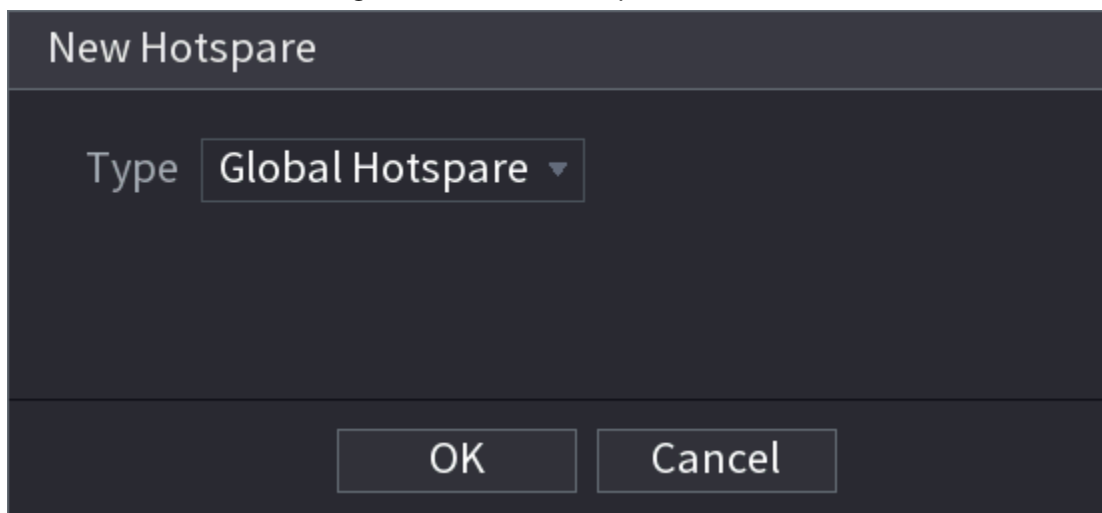

Figure 5-208 Global hotspare



Step 3 You can select **Local Hotspare** or **Global Hotspare**.

- **Local Hotspare:** Select the target disk, and the current disk will serve as the hot spare disk for the selected target disk.
- **Global Hotspare:** The current disk will serve as the hot spare disk of the entire RAID.

Step 4 Click **OK**.



Click  to delete a hot spare disk.

5.12.4 Disk Group

Background Information

By default, the installed HDD and created RAID are in Disk Group 1. You can set HDD group, and HDD group setup for main stream, sub stream and snapshot operation.

Procedure

Step 1 Select **Main Menu > STORAGE > Disk Group**.

Figure 5-209 Disk group

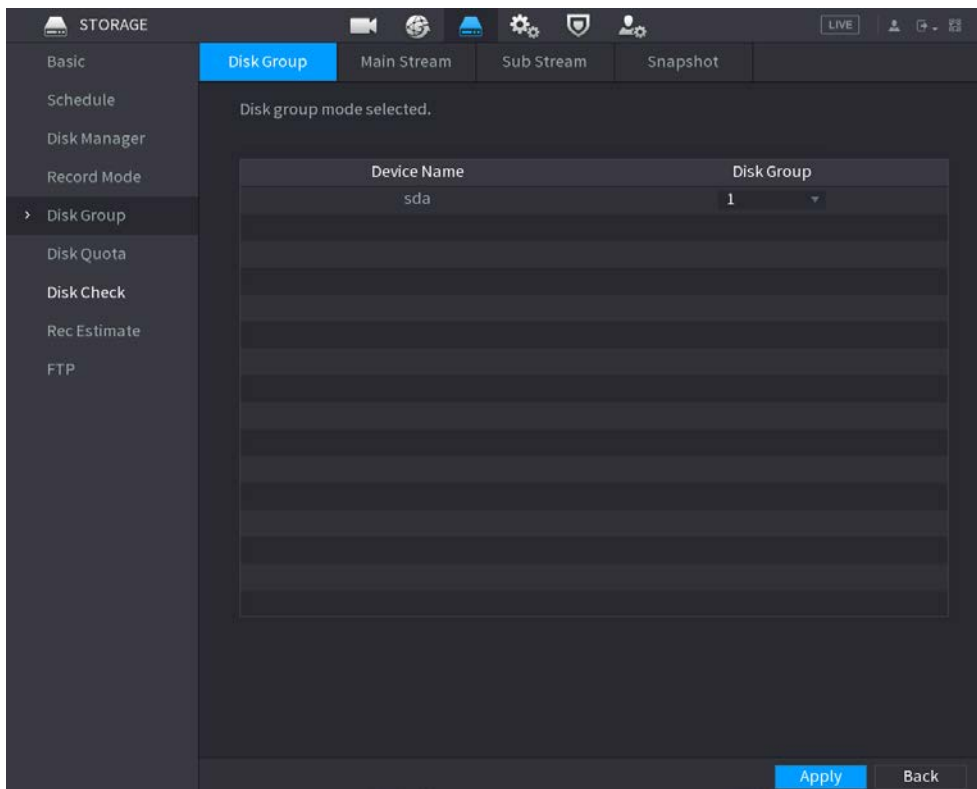

Step 2 (Optional) If **Disk Quota is selected** is shown on the page, click **Switch to Disk Group Mode** and then follow the on-screen instructions to format disks.

Step 3 Select the group for each HDD, and then click **Apply**.
After configuring HDD group, under the **Main Stream** tab, **Sub Stream** tab and **Snapshot** tab, configure settings to save the main stream, sub stream and snapshot to different disk groups.

5.12.5 Disk Quota

You can allocate a certain storage capacity for each channel to manage the storage space properly.

Background Information



- If **Disk group mode selected.** is shown in the interface, click **Switch to Quota Mode.**
- Disk quota mode and disk group mode can not be selected at the same time.

Procedure

Step 1 Select **Main Menu > STORAGE > Disk Quota.**

Figure 5-210 Disk Quota

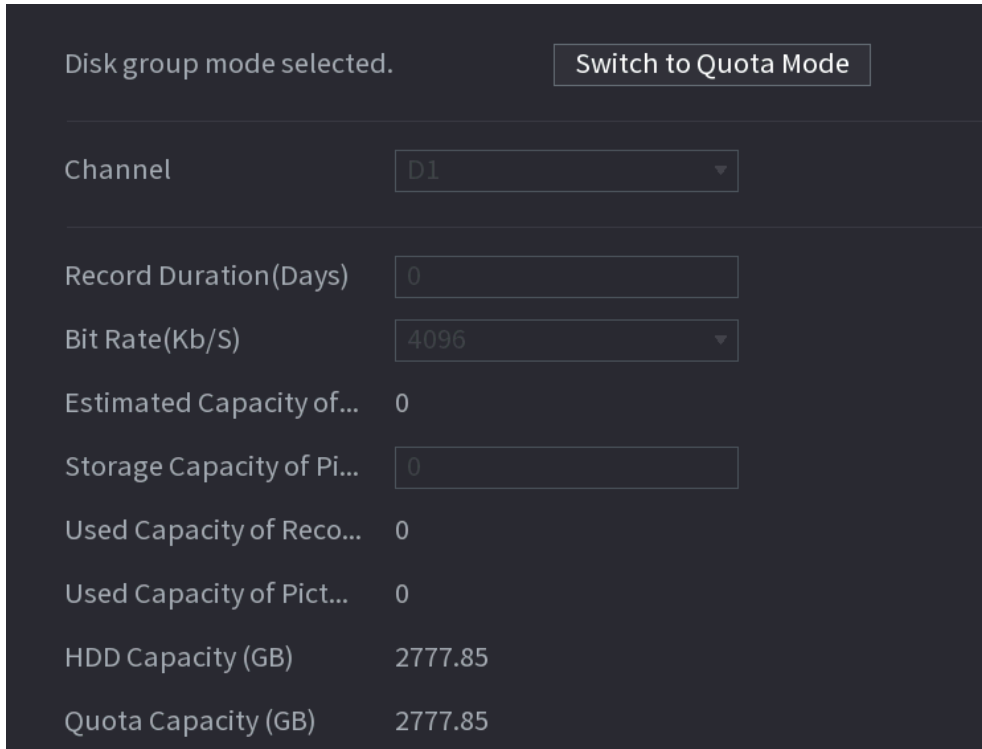

- Step 2 (Optional) If **Disk group mode selected** is shown on the page, click **Switch to Quota Mode** and then follow the on-screen instructions to format disks.
- Step 3 Select a channel and set the record duration, bit rate and storage capacity of picture.
- Step 4 Click **Apply**.

5.12.6 Disk Check

The system can detect HDD status so that you can clearly understand the HDD performance and replace the malfunctioning HDD.

5.12.6.1 Manual Check

Procedure

- Step 1 Select **Main Menu > STORAGE > Disk Check > Manual Check**.

Figure 5-211 Manual check

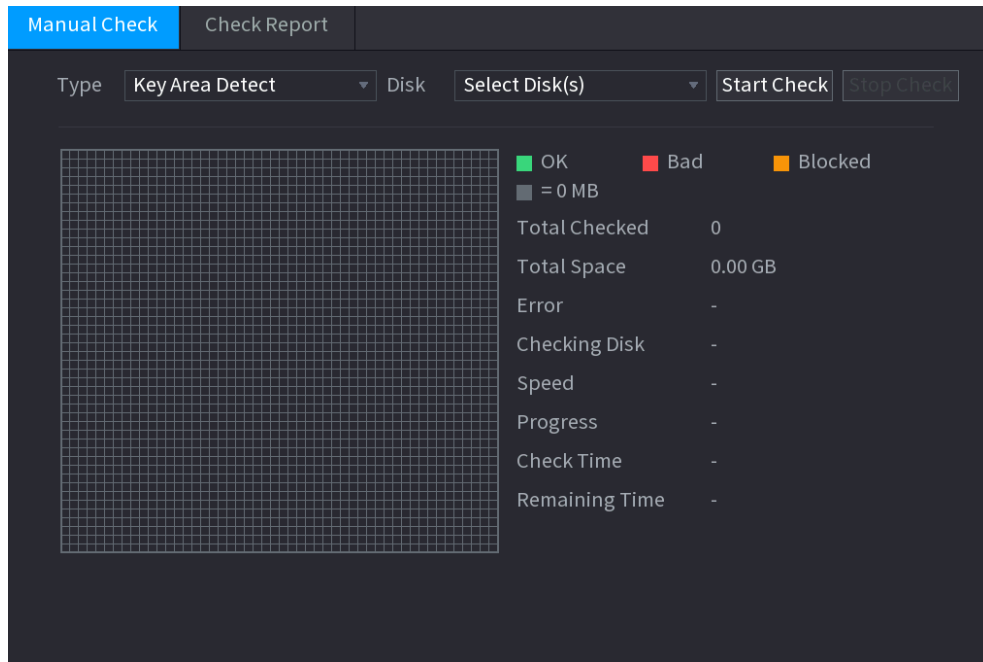

Step 2 Select the detection type.

- Key area detection: The system detects the used space of the HDD through the built-in file system. This type of detection is efficient.
- Global detection: The system detects the entire HDD through Window. This type of detection takes time and might affect the HDD that is recording.

Step 3 Select the HDD that you want to detect

Step 4 Click **Start Check**.

The system starts detecting the HDD and displays the detection information.



When system is detecting HDD, click **Stop Check** to stop current detection. Click **Start Check** to detect again.

5.12.6.2 Detection Report

Background Information

After the detection operation, you can view the detection report.

Procedure

Step 1 Select **Main Menu > STORAGE > Disk Check > Check Report**.

Figure 5-212 Check report

Manual Check		Check Report			
1	Disk No.	Check Type	Start Time	Total Space	Er
1	Host-2	Key Area Detect	2020-02-23 18:55:09	2794.52 GB	

Step 2 Click  to view detection results and S.M.A.R.T report.

Figure 5-213 Results

Details

Results S.M.A.R.T

Type

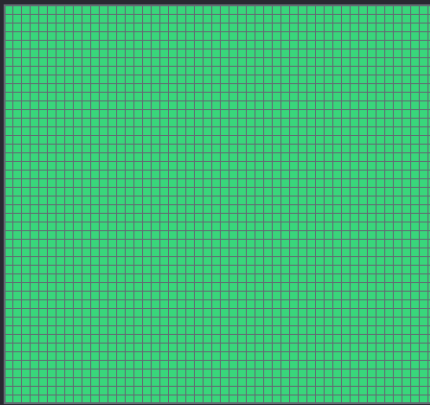

■ OK ■ Bad ■ Blocked
■ = 1244 MB

Total Checked: 1

Total Space: 2794.52 GB

Error: 0

Disk No.: 2

Bad Sector List

No.	Sector No

Figure 5-214 S.M.A.R.T

Details

Results **S.M.A.R.T**

Name sda

Model [REDACTED]

SN [REDACTED]

Health Status OK

Description:

ID	Attribute	Threshold	Value	Worst	Current Value	He
1	Read Error Rate	16	100	100	0	
2	Through Put Performance	54	135	135	85	
3	Spin Up Time	24	253	253	115	
4	Start/Stop Count	0	97	97	14390	
5	Reallocated Sector Count	5	100	100	58	

5.12.6.3 Disk Health Monitoring

Monitor health status of disks, and repair if any exceptions are found so as to avoid data loss.

Select **Main Menu > STORAGE > Disk Check > Health Monitoring**.

Click to show disk details interface. Then select **Check Type**, set time period, and then click **Search**. The system shows the details of disk monitoring status.

Figure 5-215 Disk details

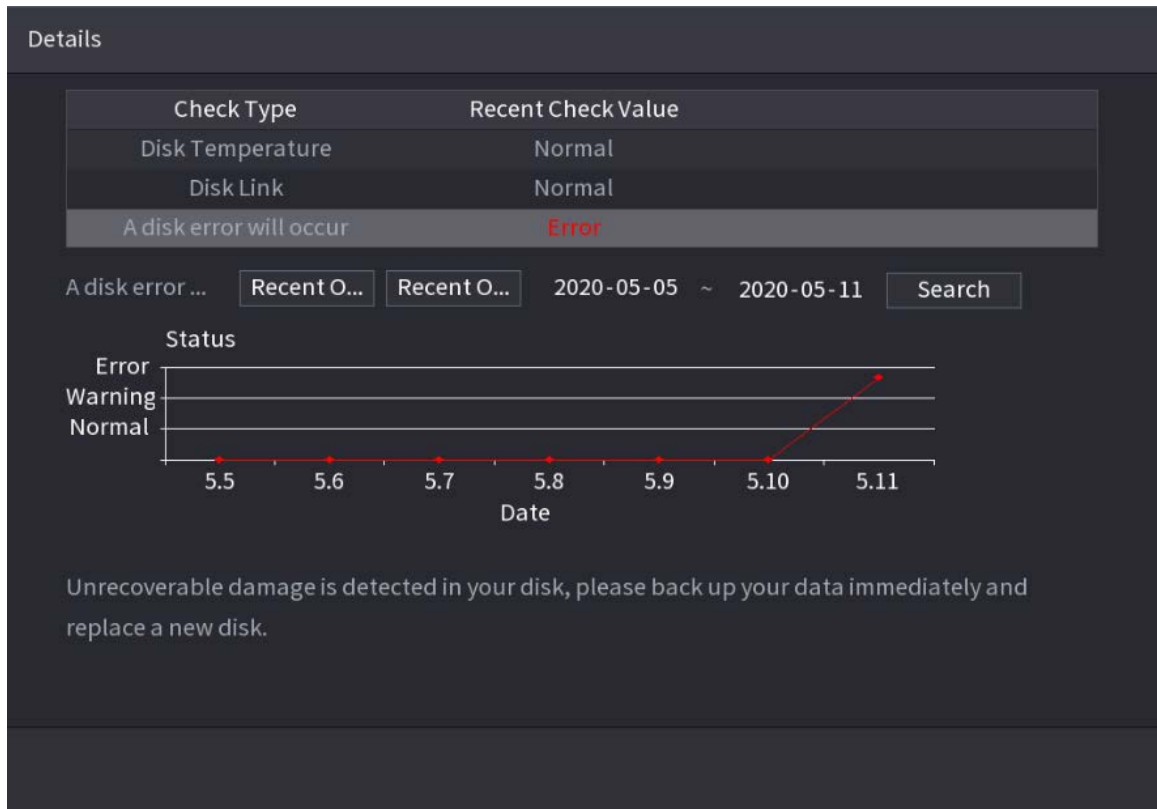

5.12.7 Record Estimate

Background Information

Record estimate function can calculate how long you can record video according to the HDD capacity, and calculate the required HDD capacity according to the record period.

Procedure

Step 1 **Select Main Menu > STORAGE > Rec Estimate.**

Figure 5-216 Record estimation

Cha...	Modify	Bit Rate(Kb/S)	Record Time	Resolution	Frame Rate(...)
<input checked="" type="checkbox"/>	1	4096	24	1920x1080(1080P)	25
<input checked="" type="checkbox"/>	2	2048	24	1920x1080(1080P)	25
<input checked="" type="checkbox"/>	3	8192	24	5120x1800(5120x...	25
<input type="checkbox"/>	4	6144	24	2560x1440	25
<input type="checkbox"/>	5	2048	24	720P	25
<input type="checkbox"/>	6	2048	24	720P	25
<input type="checkbox"/>	7	2048	24	720P	25
<input type="checkbox"/>	8	2048	24	720P	25
<input checked="" type="checkbox"/>	9	6144	24	4096x1800(4096x...	25
<input checked="" type="checkbox"/>	10	6144	24	2560x1440(2560x...	25
<input type="checkbox"/>	11	2048	24	720P	25
<input type="checkbox"/>	12	2048	24	720P	25
<input type="checkbox"/>	13	2048	24	720P	25
<input type="checkbox"/>	14	2048	24	720P	25
<input type="checkbox"/>	15	2048	24	720P	25
<input type="checkbox"/>	16	2048	24	720P	25
<input type="checkbox"/>	17	2048	24	720P	25

By Space By Time
 Total Space TB = GB
 Time Days
 Note: The record estimate data is for reference only. Please be cautious when evaluating record period.

Step 2 Click

You can configure the **Resolution**, **Frame Rate**, **Bit Rate** and **Record Time** for the selected channel.

Figure 5-217 Modify channel settings

Channel:
 Resolution:
 Frame Ra...:
 Bit Rate(...): Kb/S
 Record Time: hr.

Step 3 Click **Apply**.

Then the system will calculate the time period that can be used for storage according to the channels settings and HDD capacity.



Click **Copy to** to copy the settings to other channels.

5.12.7.1 Calculating Recording Time

Procedure

Step 1 On the **Rec Estimate** interface, click the **By Space** tab.

Figure 5-218 By space

Step 2 Click **Select**.

Step 3 Select the checkbox of the HDD that you want to calculate.

Figure 5-219 Recording time

5.12.7.2 Calculating HDD Capacity for Storage

Procedure

Step 1 On the **Rec Estimate** interface, click the **By Time** tab.

Figure 5-220 By time

Step 2 In the **Time** box, enter the time period that you want to record.
In the **Total Space** box, the required HDD capacity is displayed.

5.12.8 FTP

You can store and view the recorded videos and snapshots on the FTP server.

Prerequisites

Purchase or download a FTP (File Transfer Protocol) server and install it on your PC.



For the created FTP user, you need to set the write permission; otherwise the upload of recorded videos and snapshots will be failed.

Procedure

Step 1 Select **Main Menu > STORAGE > FTP**.

Figure 5-221 FTP

Step 2 Configure the parameters.

Table 5-67 FTP parameters

Parameter	Description
Enable	Enable the FTP upload function.

Parameter	Description
FTP type	Select FTP type. <ul style="list-style-type: none"> FTP: Plaintext transmission. SFTP: Encrypted transmission (recommended).
Server Address	IP address of FTP server.
Port	Enter the port of the FTP server. <ul style="list-style-type: none"> FTP: The default is 21. SFTP: The default is 22.
Username	Enter the username and password to log in to the FTP server. If you enable the anonymity function, you can log in anonymously without entering the username and password.
Password	
Anonymous	
Storage Path	Create folder on FTP server. <ul style="list-style-type: none"> If you do not enter the name of remote directory, the system automatically creates the folders according to the IP and time. If you enter the name of remote directory, the system creates the folder with the entered name under the FTP root directory first, and then automatically creates the folders according to the IP and time.
File Size	Enter the length of the uploaded recorded video. <ul style="list-style-type: none"> If the entered length is less than the recorded video length, only a section of the recorded video can be uploaded. If the entered length is more than the recorded video length, the whole recorded video can be uploaded. If the entered length is 0, the whole recorded video will be uploaded.
Picture Upload Interval	<ul style="list-style-type: none"> If this interval is longer than snapshot interval, the system takes the recent snapshot to upload. For example, the interval is 5 seconds, and snapshot interval is 2 seconds per snapshot, the system uploads the recent snapshot every 5 seconds. If this interval is shorter than snapshot interval, the system uploads the snapshot per the snapshot interval. For example, the interval is 5 seconds, and snapshot interval is 10 seconds per snapshot, the system uploads the snapshot every 10 seconds. To configure the snapshot interval, go to Main Menu > CAMERA > Encode > Snapshot.
Channel	Select the channel that you want to apply the FTP settings.
Day	Select the week day and set the time period that you want to upload the recorded files. You can set two periods for each week day.
Period 1, Period 2	
Record type	Select the record type (Alarm, Intel, MD, and General) that you want to upload. The selected record type will be uploaded during the configured time period.

Step 3 Click **Test** to validate the FTP connection.

If FTP connection failed, check the network and FTP settings.

Step 4 Click **Apply**.

5.12.9 iSCSI

Background Information

Internet Small Computer Systems Interface (iSCSI) is a transport layer protocol that works on top of the Transport Control Protocol (TCP), and enables block-level SCSI data transport between the iSCSI initiator and the storage target over TCP/IP networks. After the network disk is mapped to the NVR device through iSCSI, the data can be stored on the network disk.



This function is available on select models.

Procedure

Step 1 Select **Main Menu > STORAGE > iSCSI**.

Figure 5-222 iSCSI

No.	Status	IP Address	Port	Username	Storage Path
ISCSI1	X	172.16.0.2	3260	ryl13209	2211

Step 2 Set parameters.

Table 5-68 iSCSI parameters

Parameter	Description
Server Address	Enter the server address of iSCSI server.
Port	Enter the port of iSCSI server, and the default value is 3260.

Parameter	Description
Storage Path	Click Storage Path to select a remote storage path. Each path represents an iSCSI shared disk and these paths are generated when created on the server
Username, Password	Enter the username and password of iSCSI server.  If anonymous login is supported by iSCSI server, you can enable Anonymous to log in as an anonymous user.

Step 3 Click **Apply**.

5.13 Account

You can manage users, user group and ONVIF user, and set admin security questions.

5.13.1 Group

Background Information

The accounts of the Device adopt two-level management mode: user and user group. Every user must belong to a group, and one user only belongs to one group.

The **admin** and **user** group are two default user groups that cannot be deleted. You can add more groups and define corresponding permissions.

Procedure

Step 1 Select **Main Menu > ACCOUNT > Group**.

Figure 5-223 Group

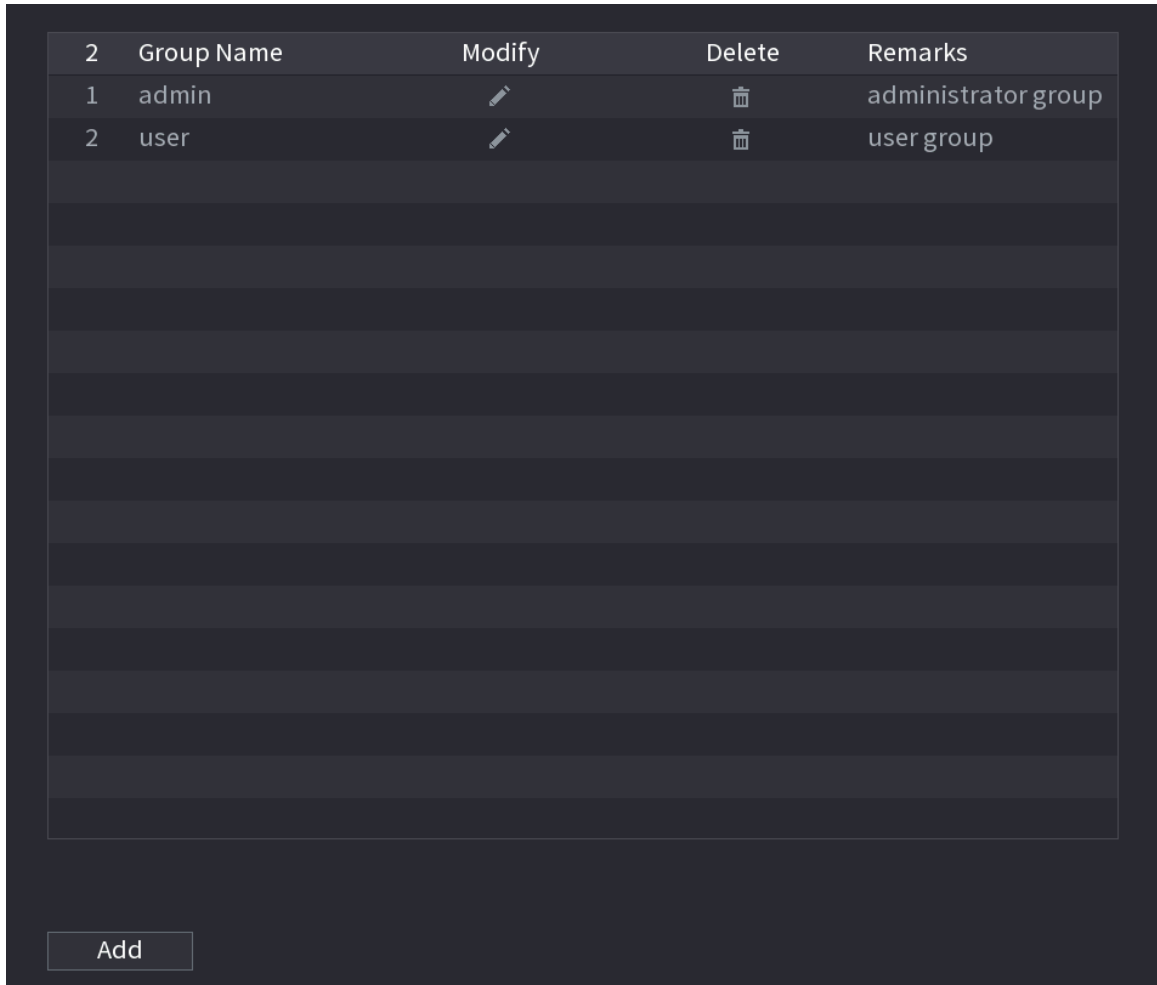

Step 2 Click **Add**.

Step 3 Enter group name and then enter some remarks if necessary.

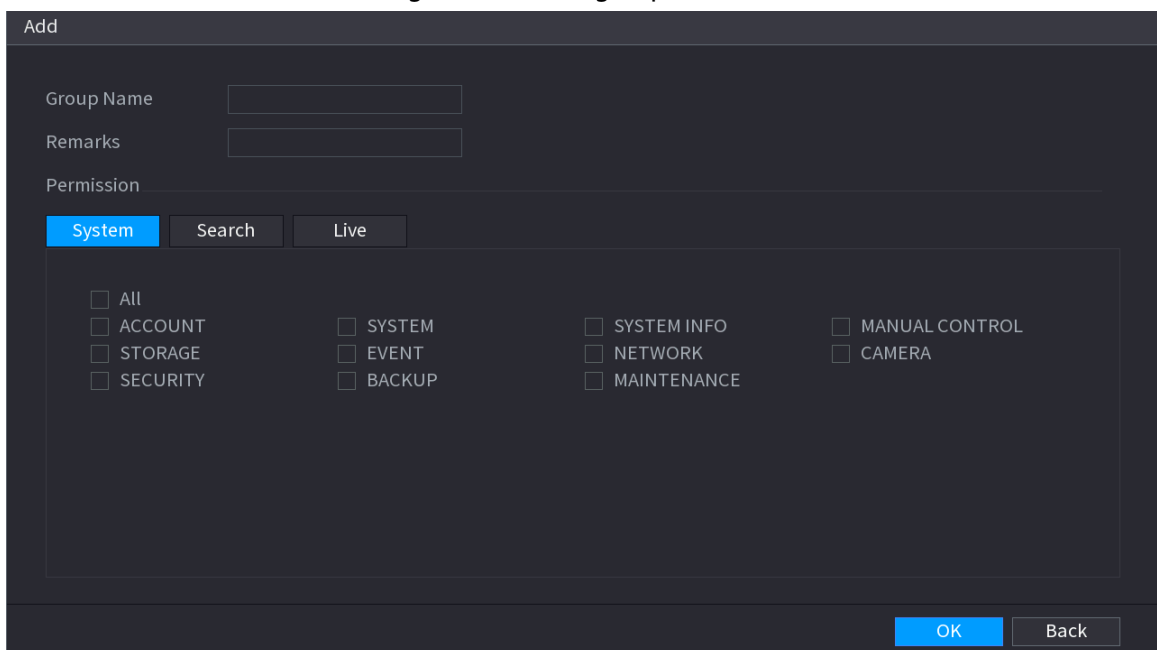

Figure 5-224 Add group



Step 4 Select the checkboxes to select permissions.

Step 5 Click **OK**.



Click  to modify the corresponding group information, click  to delete the group.

5.13.2 User

5.13.2.1 Adding User

Procedure

Step 1 Select **Main Menu > ACCOUNT > User**.

Figure 5-225 User

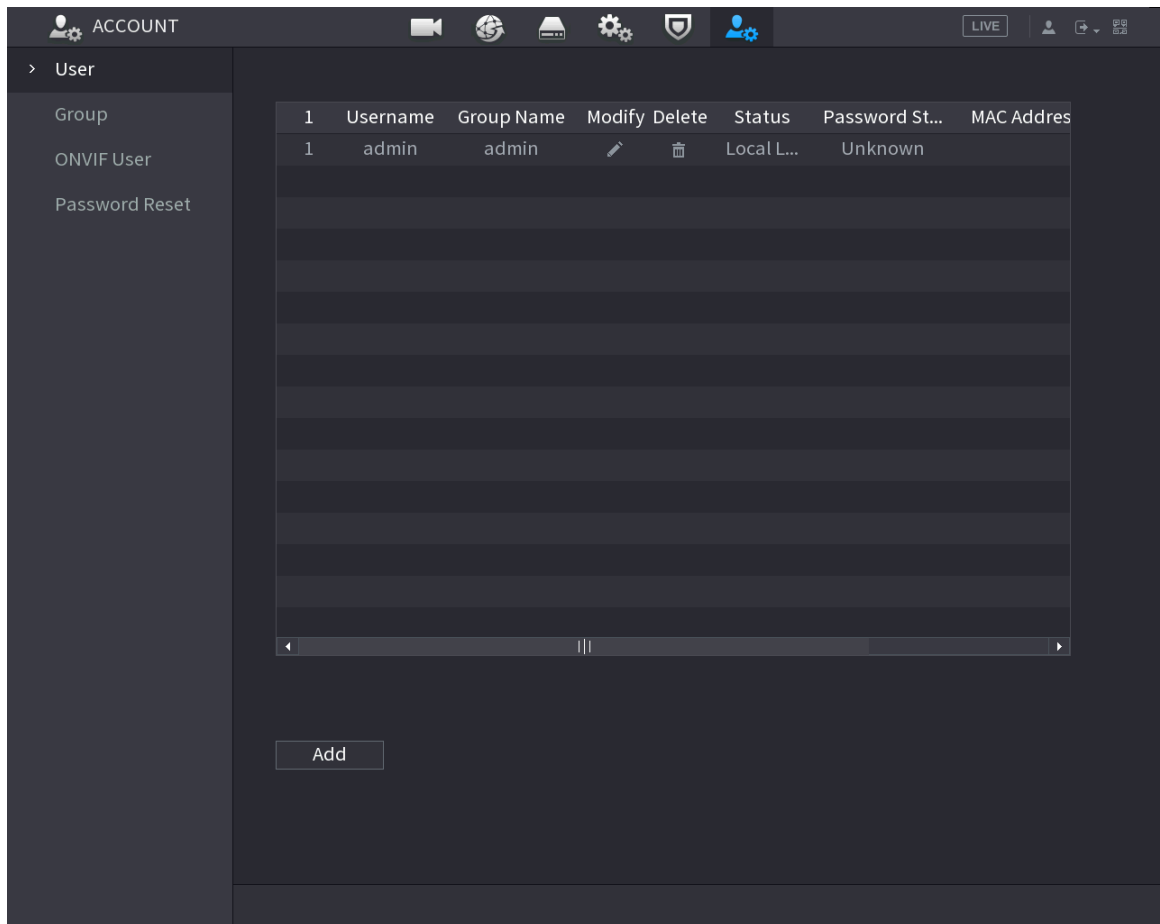

Step 2 Click **Add**.

Figure 5-226 Add user

Step 3 Configure the parameters.

Table 5-69 Parameters of adding user

Parameter	Description
Username	Enter a username and password for the account.
Password	
Confirm Password	Enter the password again to confirm it.
Remarks	Optional. Enter a description of the account.
User MAC	Enter user MAC address
Group	Select a group for the account. The user rights must be within the group permissions.
Period	Click Setting to define a period during which the new account can log in to the Device. The new account cannot access the device during other periods.
Permission	Select the checkboxes to grant permissions to the user. To manage the user account easily, when defining the user account permission, do not give the authority to the common user account higher than the advanced user account.

Step 4 Click **OK**.



Click to modify the corresponding user information, click to delete the user.

5.13.2.2 Changing Password

Background Information

We recommend you change the password regularly to enhance device security.



Users with account permissions can change the password of other users.

Procedure

Step 1 Select **Main Menu > ACCOUNT > User**.

Step 2 Click of the corresponding user.

Figure 5-227 Change password

Step 3 Click to enable the **Modify Password** function.

Step 4 Enter old password and then enter new password twice.



- The password must consist of 8–32 non-blank characters and contain at least two types of the following characters: uppercase, lowercase, numbers, and special characters (excluding ' " ; : &).
- For your device security, create a strong password.
- Check the box to enable Unlock Pattern function, click .

Step 5 Click to enable **Unlock Pattern** and then click to draw the pattern.

Step 6 Click **OK**.

5.13.3 Resetting Password

You can reset the password when you forget the password.

5.13.3.1 Enabling Password Reset

Background Information

Enable the password reset function and configure the linked email address and security questions that are used to reset the password.

Procedure

Step 1 Select **Main Menu > ACCOUNT > Password Reset.**

Step 2 Click to enable the password reset function.



This function is enabled by default.

Step 3 Enter an email address to receive the security code used to reset the password.

Step 4 Configure security questions and answers.

Step 5 (Optional) Follow the on-screen instructions to bind the Device to DMSS app.

Figure 5-228 Bind device

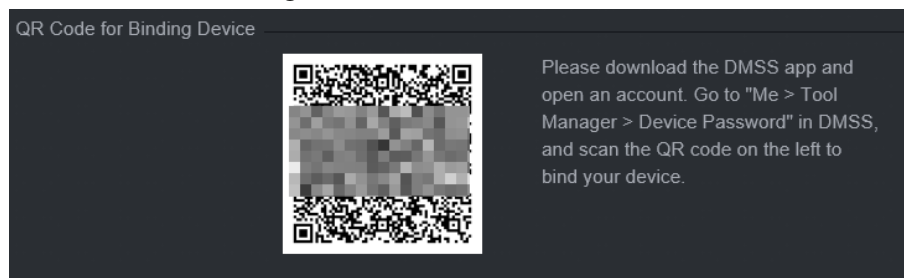

Step 6 Click **OK**.

5.13.3.2 Resetting Password on Local Interface

Procedure

Step 1 Right-click the live page and then select any item on the shortcut menu.

- If you have configured unlock pattern, the unlock pattern login window is displayed. Click **Forgot Pattern** to switch to password login.
- If you did not configure unlock pattern, the password login window is displayed.

Figure 5-229 Pattern login

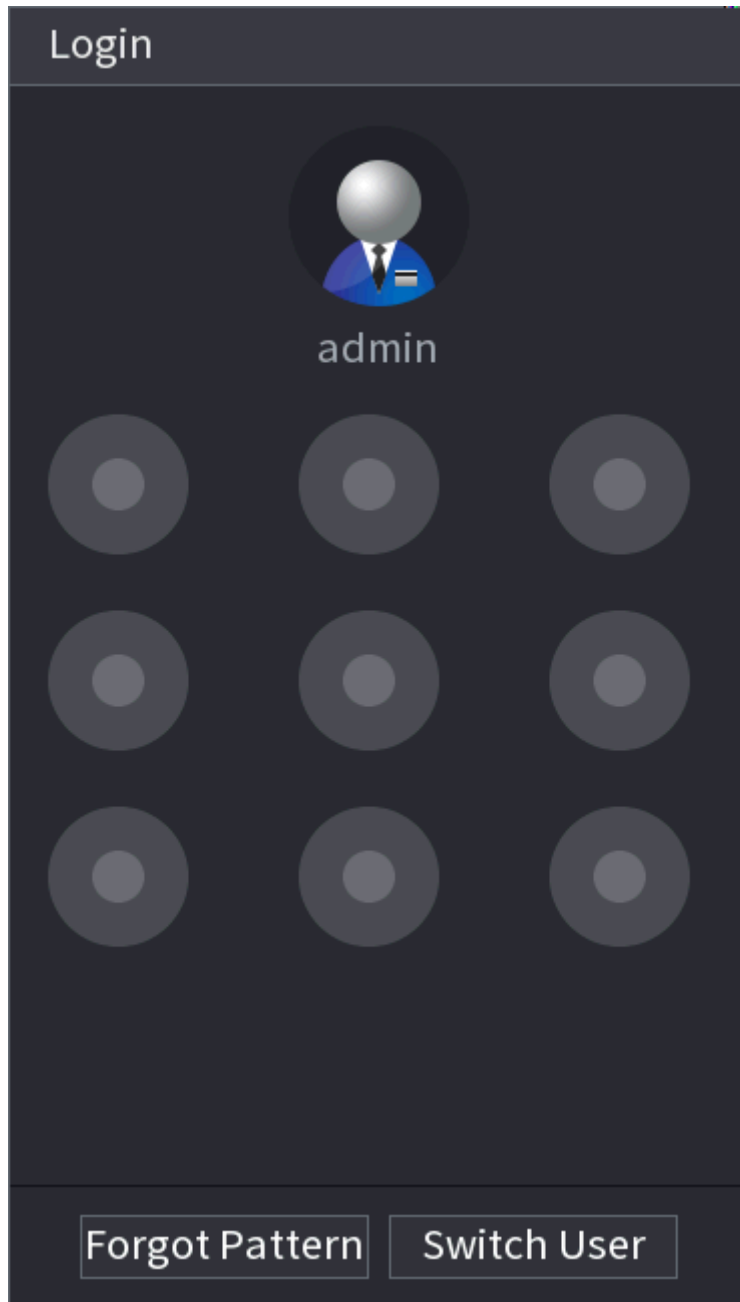

Figure 5-230 Password login

Step 2 Click .

- If you have set the linked email address, the system will notify you of data collection required for resetting password. Click **OK**.
- If you did not set the linked email address, the system prompts you to enter an email address. Enter the email address and then click **Next**. Then the system will notify you of data collection required for resetting password.

Figure 5-231 Notification on data collection

Step 3 Read the prompt and then click **OK**.

Step 4 Click **Next**.



After clicking **Next**, the system will collect your information for password reset, purpose and the information includes but not limited to email address, MAC address, and device serial number. Read the prompt carefully before clicking **Next**.

Step 5 Reset the password.

- Email.

Select **Email** as the reset mode, and then follow the on-screen instructions to get the security code in your linked email address. After that, enter the security code in the **Security Code** box.

Figure 5-232 Reset mode (email)



- App.Select **QR Code for Binding Device** as the reset mode, and then follow the on-screen instructions to get the security code on the DMSS app. After that, enter the security code in the **Security Code** box.

Figure 5-233 Reset mode (app)

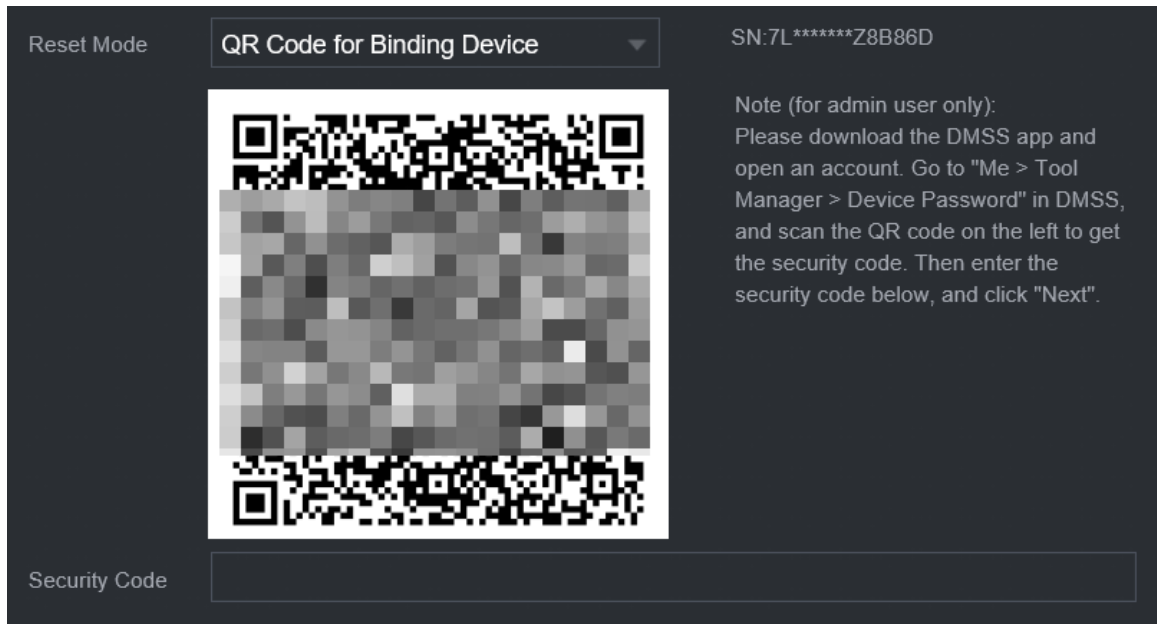

- Security question.
Select **Security Question** as reset mode and then answer the security questions.



If you did not configure the security questions in advance , **Security Question** is not available on the **Reset Mode** list.

Step 6 Click **Next**.

Step 7 Enter the new password and then enter the password again to confirm it.

Figure 5-234 Enter new password

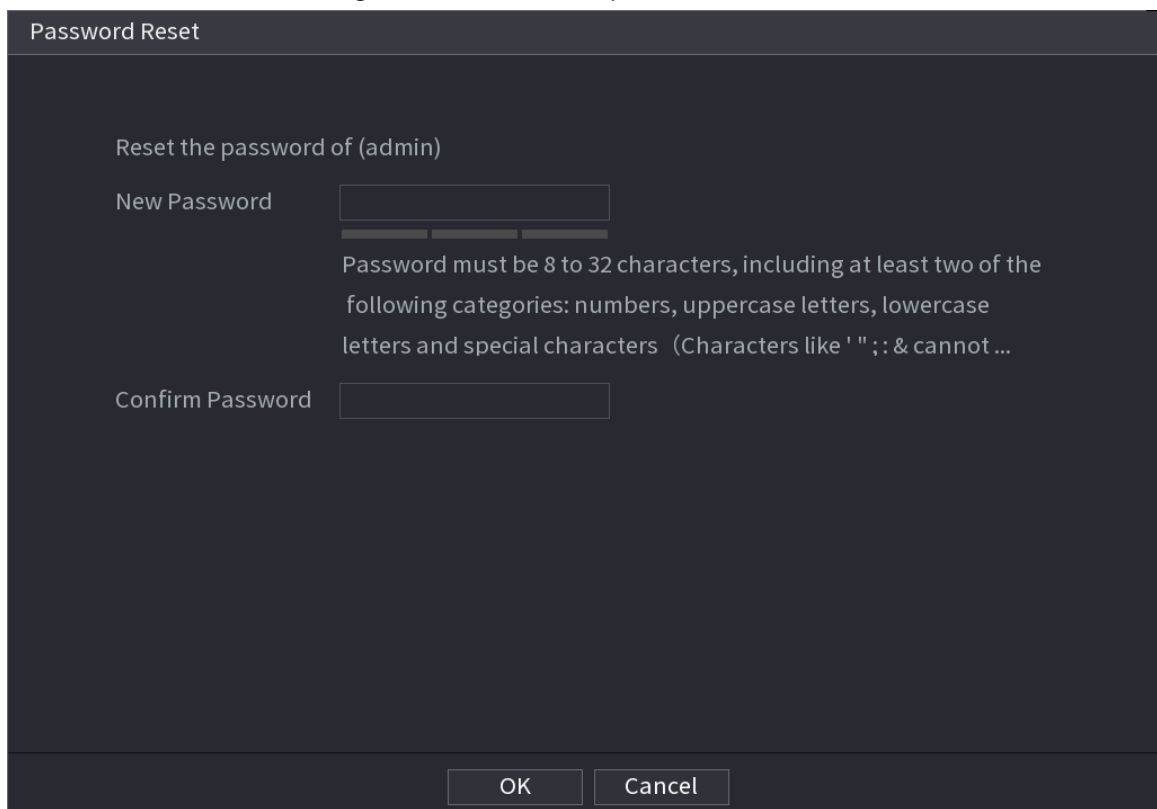

Step 8 Click **OK**.

The password is reset.

- Step 9 (Optional) When the system prompts whether to synchronize the password with the remote devices accessed through the private protocol, click **OK** to synchronize the password.

5.13.4 ONVIF User

Background Information

To connect the camera from the third party to the NVR via the ONVIF protocol, you need to use a verified ONVIF account.



The default ONVIF user is **admin**. It is created after you initialize the NVR and cannot be deleted.

Procedure

- Step 1 Select **Main Menu > ACCOUNT > ONVIF User**.

Figure 5-235 ONVIF user

1	Username	Group Name	Modify	Delete	Password S...
1	admin	admin			Medium

- Step 2 Click **Add**.

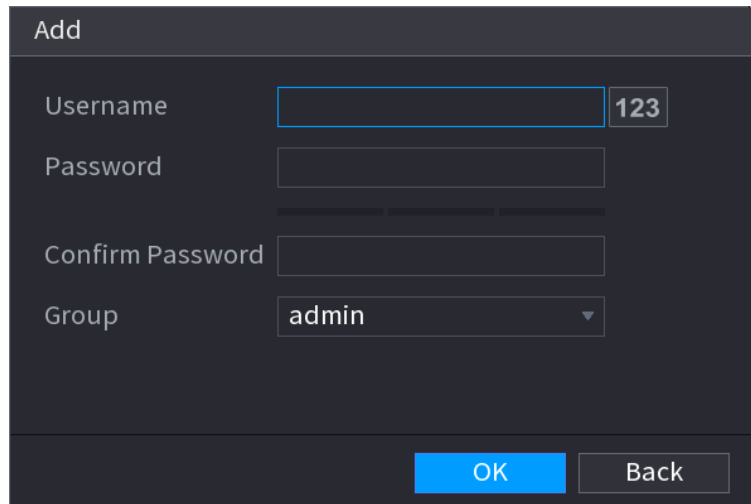

Figure 5-236 Add ONVIF user



Step 3 Configure username, password and user group.

Step 4 Click **OK**.



Click  to modify the corresponding user information, click  to delete current user.

5.14 Security

5.14.1 Security Status

Security scanning helps get a whole picture of device security status. You can scan user, service and security module status for detailed information on the security status of the device.

Detecting User and Service



Green icon represents a healthy status of the scanned item, and orange icon represents a risky status.

- Login authentication: When there's a risk in the device configuration, the icon will be in orange to warn risk. You can click **Details** to see the detailed risk description.
- User Status: When one of device users or ONVIF users uses weak password, the icon will be in orange to warn risk. You can click **Details** to optimize or ignore the risk warning.

Figure 5-237 Security status

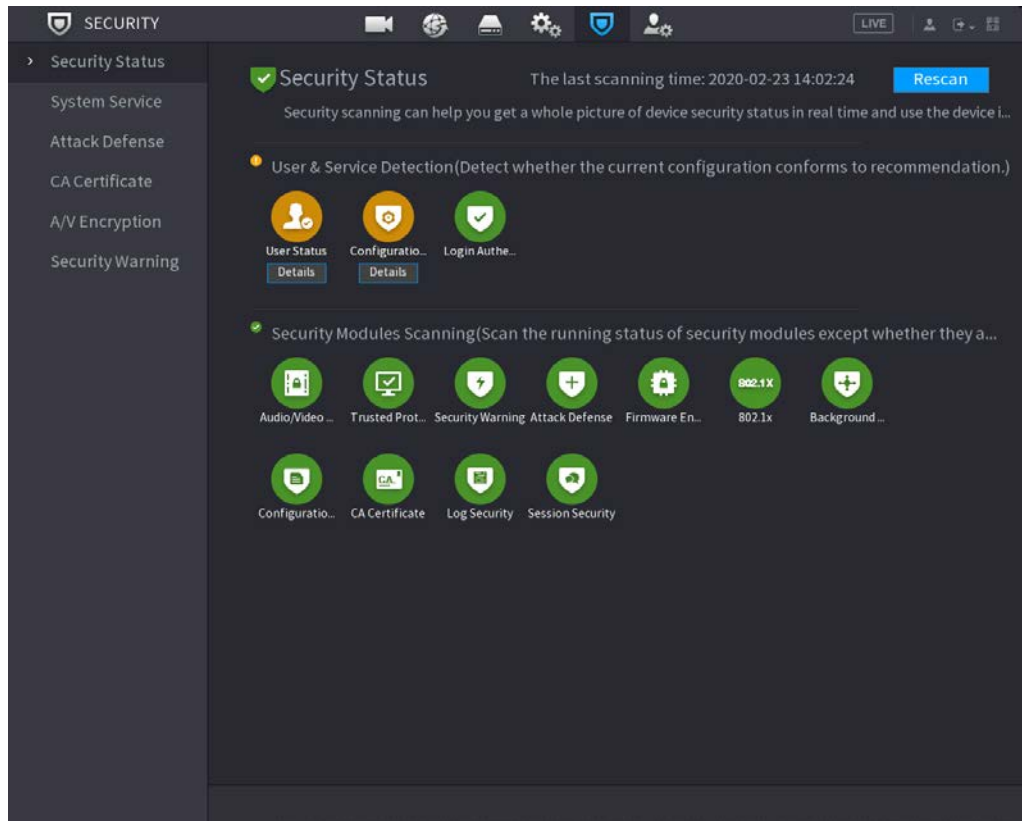
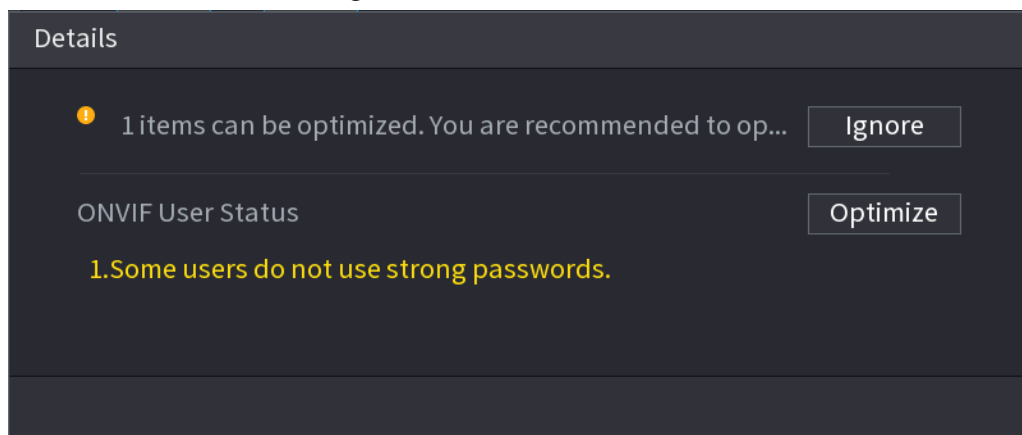
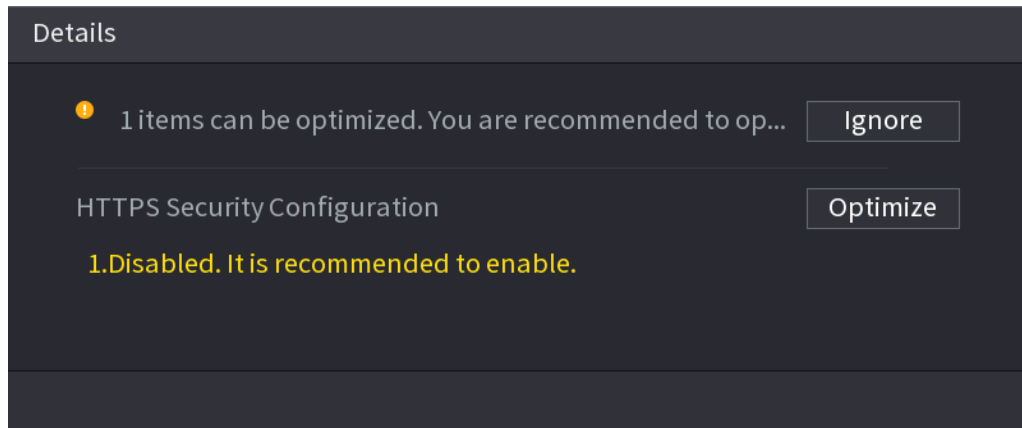

Figure 5-238 Details (1)



- Configuration Security: When there's a risk in the device configuration, the icon will be in orange to warn risk. You can click **Details** to see the detailed risk description.

Figure 5-239 Details (2)



Scanning Security Modules

This area shows the running status of security modules. For details about the security modules, point to the icon to see the on-screen instructions.

Re-scanning Security Status

You can click **Rescan** to scan security status.

5.14.2 System Service

You can set NVR basic information such as basic services, 802.1x and HTTPS.

5.14.2.1 Basic Services

Procedure

Step 1 Select **Main Menu > SECURITY > System Service > Basic Services**.

Figure 5-240 Basic services

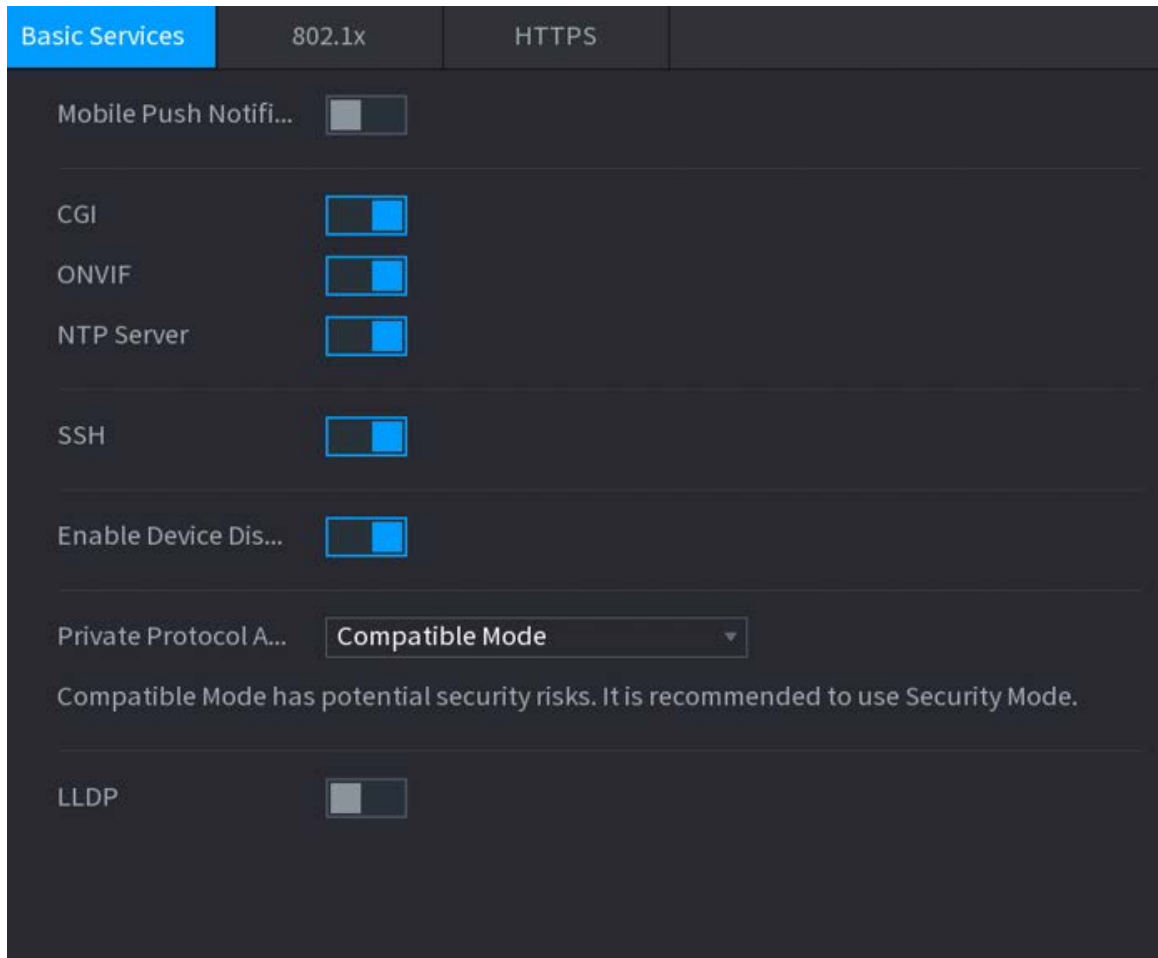

Step 2 Enable the system services.



There might be safety risk when **Mobile Push Notifications, CGI, ONVIF, SSH and NTP Server** is enabled. Disable these functions when they are not needed.

Table 5-70 Basic service parameters

Parameter	Description
Mobile Push Notifications	After enabling this function, the alarm triggered by the NVR can be pushed to a mobile phone. This function is enabled by default.
CGI	If this function is enabled, the remote devices can be added through the CGI protocol. This function is enabled by default.
ONVIF	If this function is enabled, the remote devices can be added through the ONVIF protocol. This function is enabled by default.
NTP Server	After enabling this function, a NTP server can be used for time synchronization. This function is enabled by default.
SSH	After enabling this function, you can use SSH service. This function is disabled by default.
Enable Device Discovery	After enabling this function, the NVR can be found by other devices through searching.

Parameter	Description
Private Protocol Authentication Mode	<ul style="list-style-type: none"> Security Mode (Recommended): Uses Digest access authentication when connecting to NVR. Compatible Mode: Select this mode when the client does not support Digest access authentication.
LLDP	Enable the LLDP service. The Link Layer Discovery Protocol (LLDP) allows two different devices to collect hardware and protocol information about neighboring devices, which is useful in troubleshooting the network.

Step 3 Click **Apply**.

5.14.2.2 802.1x

The Device needs to pass 802.1x certification to enter the LAN.

Procedure

Step 1 Select **Main Menu > SECURITY > System Service > 802.1x**.

Figure 5-241 802.1x

The screenshot displays the configuration page for 802.1x. The '802.1x' tab is active. The configuration includes:

- NIC Name:** A dropdown menu set to 'NIC 1'.
- Enable:** A toggle switch currently turned off.
- Authentication:** A dropdown menu set to 'PEAP'.
- CA Certificate:** A toggle switch currently turned on.
- Username and Password:** Two empty text input fields.
- CA Certificate Selection:** A section titled 'Please select a trusted CA certificate.' with a 'Certificate Management' button. It contains a table with the following data:

No.	Certificate Serial Number	Valid Period
1	XXXXXXXXXXXXXXXXXXXX	2027-03-04 01:46:55

At the bottom right, there are 'Apply' and 'Back' buttons.

Step 2 Select the Ethernet card you want to certify.

Step 3 Select **Enable** and configure parameters.

Table 5-71 802.1x parameters

Parameter	Description
Authentication	<ul style="list-style-type: none"> • PEAP: protected EAP protocol. • TLS: Transport Layer Security. Provide privacy and data integrity between two communications application programs.
CA Certificate	Enable it and click Browse to import CA certificate from flash drive. For details about importing and creating a certificate, see "5.14.4 CA Certificate".
Username	The username shall be authorized at server.
Password	Password of the corresponding username.

Step 4 Click **Apply**.

5.14.2.3 HTTPS

Background Information

We recommend you enable HTTPS function to enhance system security.

Procedure

Step 1 Select **Main Menu > SECURITY > System Service > HTTPS**.

Figure 5-242 HTTPS

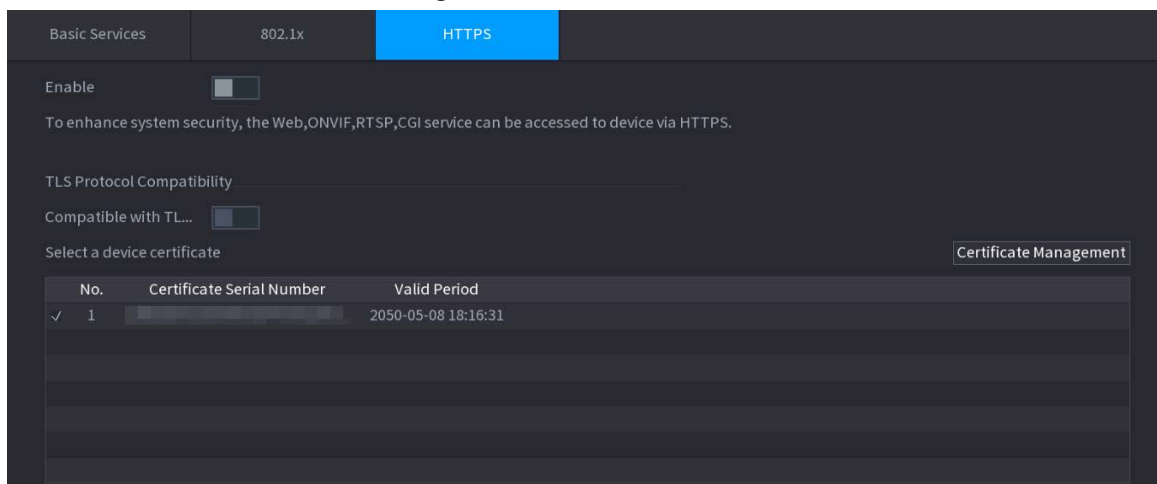

Step 2 Enable HTTPS function.

Step 3 (Optional) Enable **Compatible with TLSv1.1 and earlier versions** to allow protocol compatibility.

Step 4 Click **Certificate Management** to create or import a HTTPS certificate from USB drive. For details about importing or creating a CA certificate, see "5.14.4 CA Certificate".

Step 5 Select a HTTPS certificate.

Step 6 Click **Apply**.

5.14.3 Attack Defense

5.14.3.1 Firewall

Background Information

You can configure the hosts that are allowed or prohibited to access the Device.

Procedure

Step 1 Select **Main Menu > SECURITY > Attack Defense > Firewall** .

Figure 5-243 Firewall

Step 2 Click  to enable the firewall.

Step 3 Select a firewall mode.

- **Allow List:** The hosts on the allowlist can access the Device.
- **Block List:** The hosts on the blocklist are prohibited to access the Device.

Step 4 Click **Add** and then select a type for the allowlist or blocklist.

You can allow or prohibit hosts through a specific IP address, a network segment, or a MAC address.

- IP address.
Enter the IP address, start port and end port, and then click **OK**.
- IP segment.
Enter the start address and end address, starting port and ending port, and then click **OK**.
- MAC address.
Enter the MAC address, and then click **OK**.

Step 5 Click **Apply**.

5.14.3.2 Account Lockout

Procedure

Step 1 Select **Main Menu > SECURITY > Attack Defense > Account Lockout**.

Figure 5-244 Account lockout

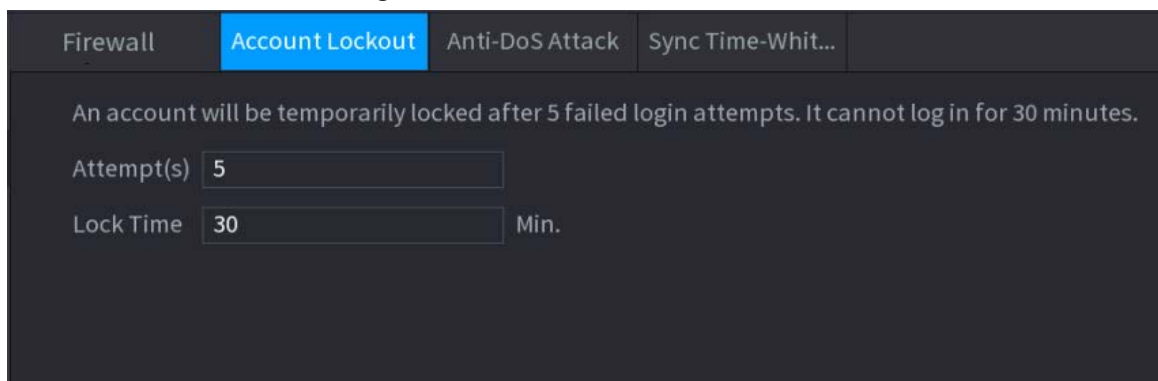

Step 2 Set parameters.

Table 5-72 Account lockout parameters

Parameter	Description
Attempt(s)	Set the maximum number of allowable wrong password entries. The account will be locked after your entries exceed the maximum number.
Lock Time	Set how long the account is locked for.

Step 3 Click **Apply**.

5.14.3.3 Anti-DoS Attack

You can enable **SYN Flood Attack Defense** and **ICMP Flood Attack Defense** to defend the Device against Dos attack.

Figure 5-245 Anti-Dos Attack

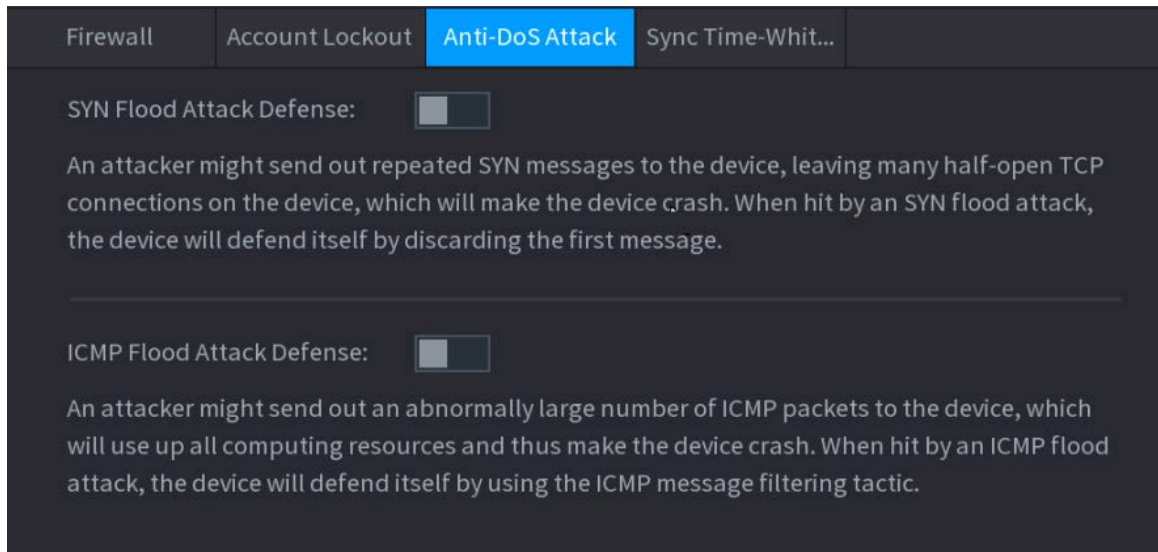

5.14.3.4 Sync Time-Allowlist

Background Information

You can configure which hosts are allowed to synchronize time with the Device.

Procedure

Step 1 Select **Main Menu > SECURITY > Attack Defense > Sync Time-Allowlist**.

Figure 5-246 Sync Time-Allowlist

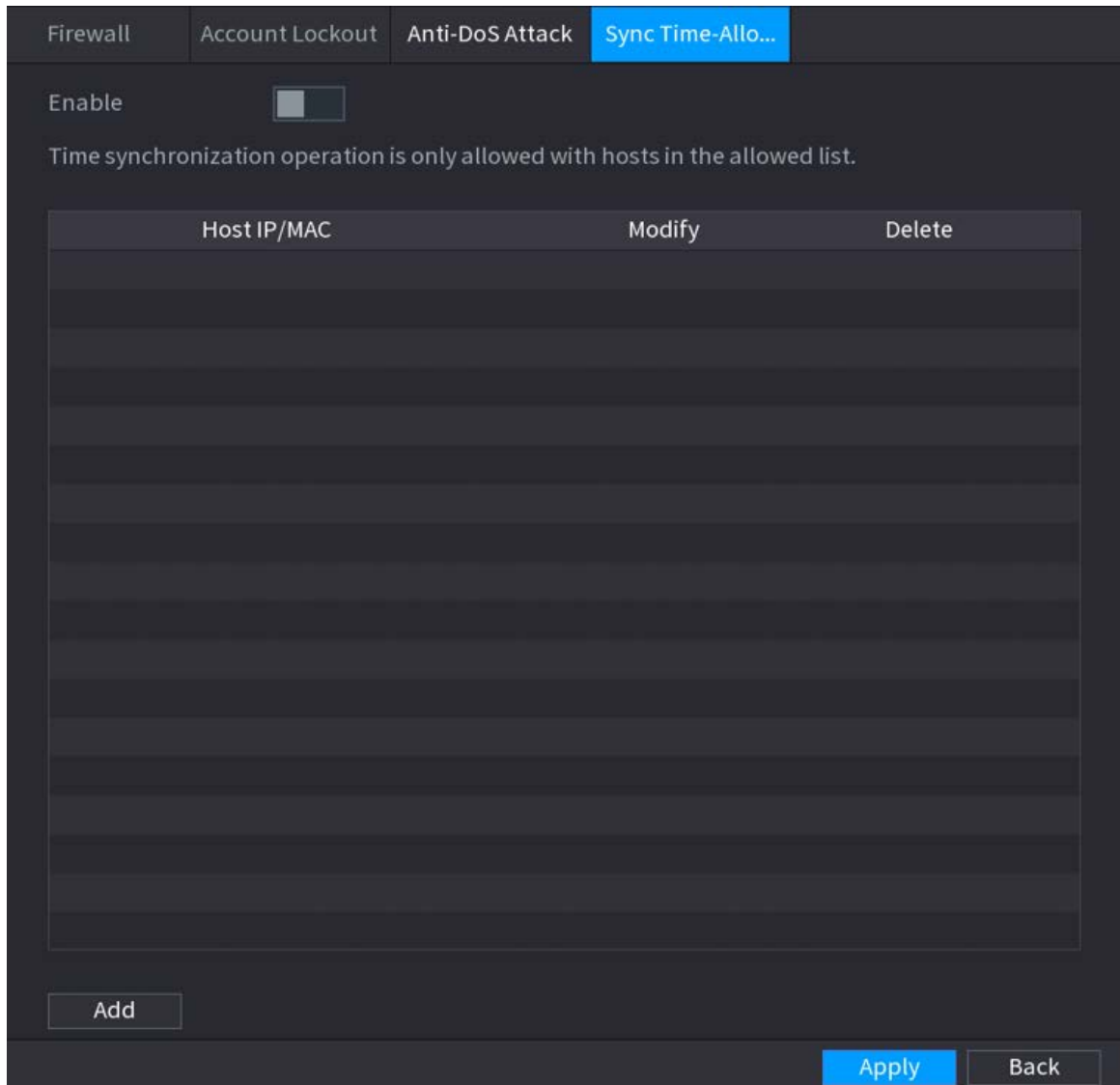

Step 2 Click  to enable the function.

Step 3 Click **Add** to add trusted hosts for time synchronization.

- If you set **Type** to **IP Address**, enter the IP address, and then click **OK**.
- If you set **Type** to **IP Segment**, enter the start address and end address, and then click **OK**.

Step 4 Click **Apply**.

5.14.4 CA Certificate

5.14.4.1 Device Certificate

Create Certificate

1. Select **Main Menu > SECURITY > CA Certificate > Device Certificate**. Figure 5-247 Device certificate

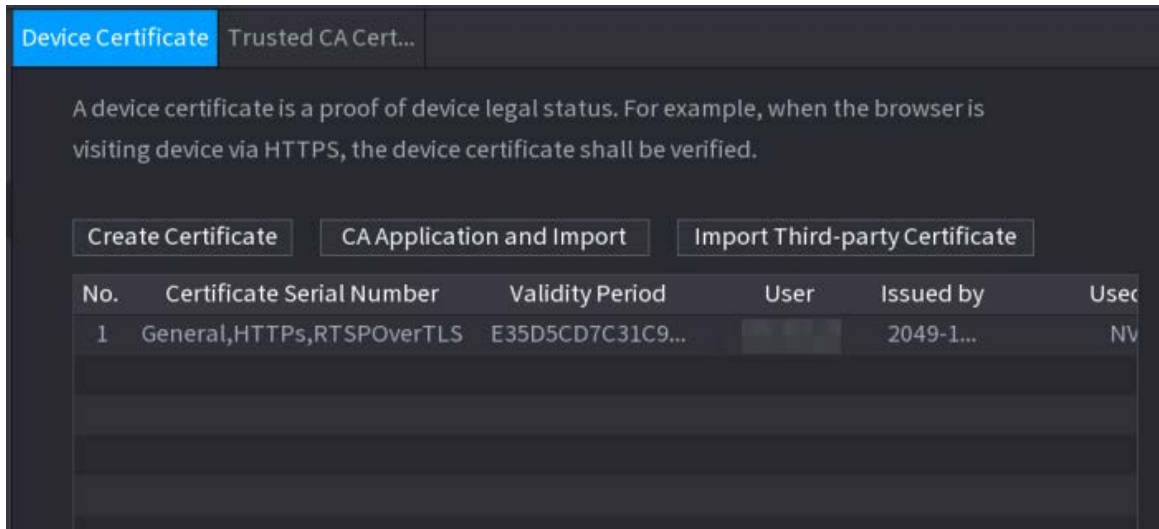

2. Click **Create Certificate**.

Figure 5-248 Create certificate

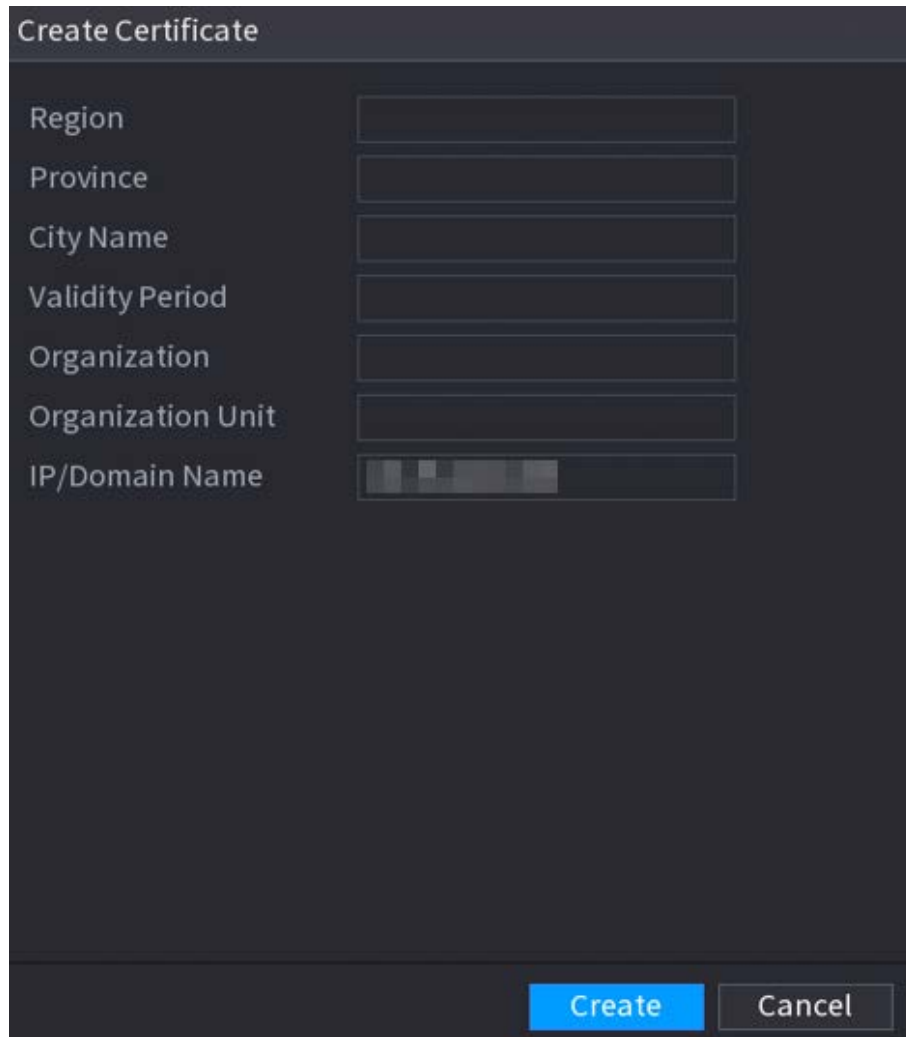

Create Certificate

Region

Province

City Name

Validity Period

Organization

Organization Unit

IP/Domain Name

3. Configure the parameters.
4. Click **Create**.

CA Application and Import

Click **CA Application and Import** and then follow the on-screen instructions to finish CA application and import.

Figure 5-249 CA application and import

CA Application and Import

Procedure:

Step 1: Select 'Create Certificate Request' to generate a certificate request file.

Step 2: Submit the certificate request file to a third-party CA institution to apply for a certificate.

Step 3: Select 'Import Certificate' and then import the CA certificate issued by the third-party institution.

Type

Create Certificate ...

Import Certificate

Region

Province

City Name

Validity Period

Organization

Organization Unit

IP/Domain Name

Create

Cancel

Import Third-Party Certificate

1. Click **Import Third-Party Certificate**
2. Configure the parameters.

Table 5-73 Parameters for importing third-party certificate

Parameter	Description
Path	Click Browse to find the third-party certificate path on the USB drive.
Private Key	Click Browse to find the third-party certificate private key on the USB drive.
Private Key Password	Input the private key password.

3. Click **Create**.

5.14.4.2 Trusted CA Certificate

Procedure

- Step 1 Select **Main Menu > SECURITY > CA Certificate > Trusted CA Certificate**.
- Step 2 Click **Install Trusted Certificate**.

Figure 5-250 Create certificate

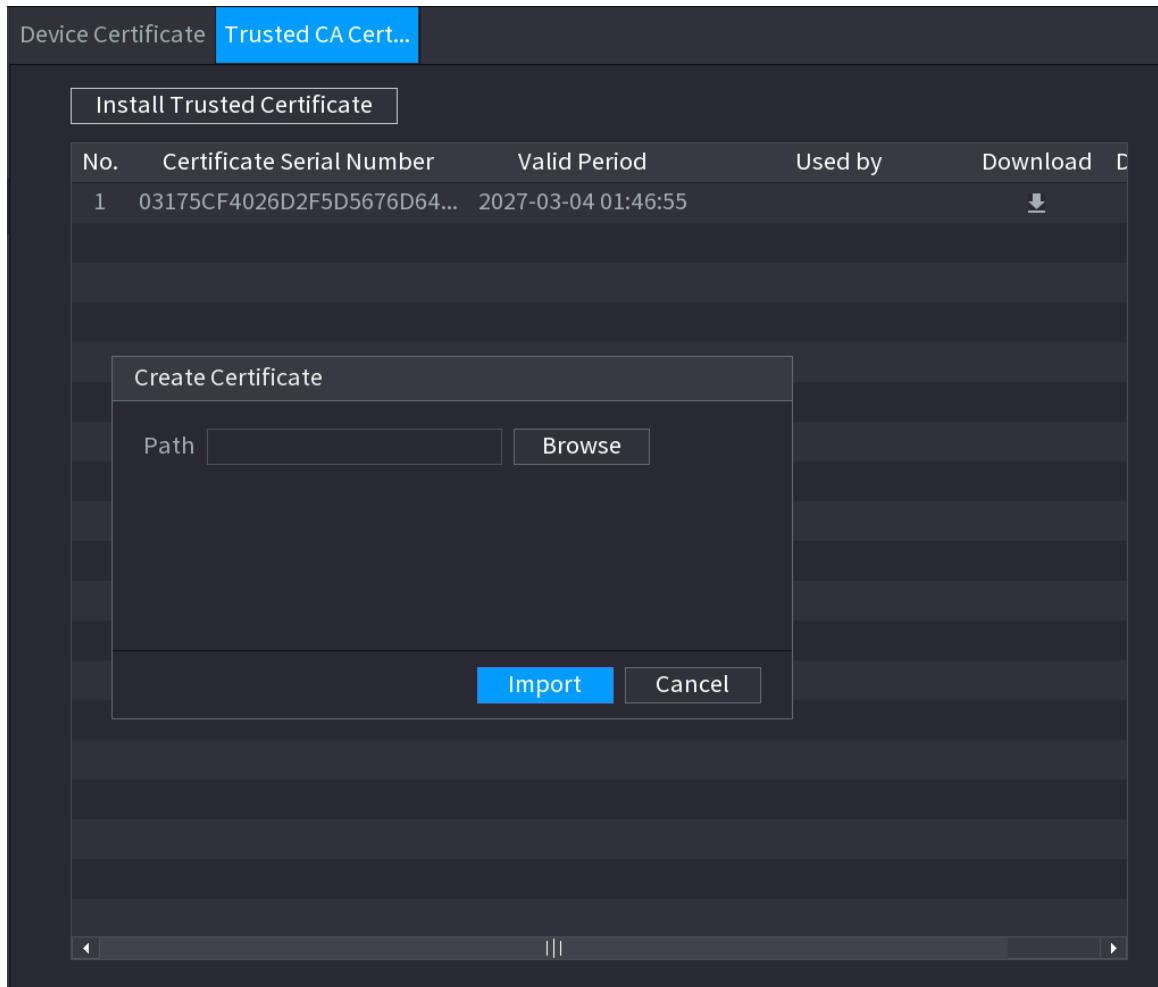

Step 3 Click **Browse** to select the certificate that you want to install.

Step 4 Click **Import**.

5.14.5 Audio/Video Encryption

Background Information

The Device supports audio and video encryption during data transmission.

Procedure

Step 1 Select **Main Menu > SECURITY > AUDIO/VIDEO ENCRYPTION > Audio/Video Transmission**.

Figure 5-251 Audio and video transmission

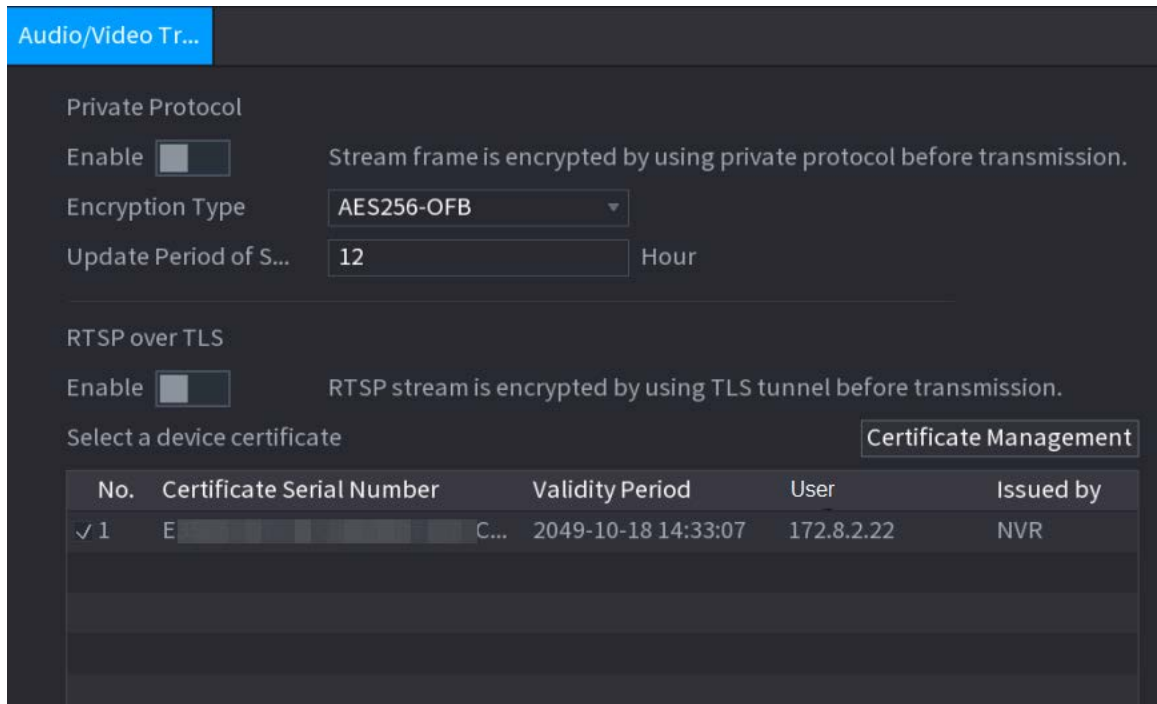

Step 2 Configure parameters.

Table 5-74 Audio and video transmission parameters

Area	Parameter	Description
Private Protocol	Enable	Enables stream frame encryption by using private protocol. There might be safety risk if this service is disabled.
	Encryption Type	Use the default setting.
	Update Period of Secret Key	Secret key update period. Value range: 0–720 hours. 0 means never update the secret key. Default value: 12.
RTSP over TLS	Enable	Enables RTSP stream encryption by using TLS. There might be safety risk if this service is disabled.
	Select a device certificate	Select a device certificate for RTSP over TLS.
	Certificate Management	For details about certificate management, see "5.14.4.1 Device Certificate".

Step 3 Click **Apply**.

5.14.6 Security Warning

5.14.6.1 Security Exception

Background Information

The Device gives warnings to the user when a security exception occurs.

Procedure

Step 1 Select **Main Menu > SECURITY > Security Warning > Security Exception.**

Figure 5-252 Security exception

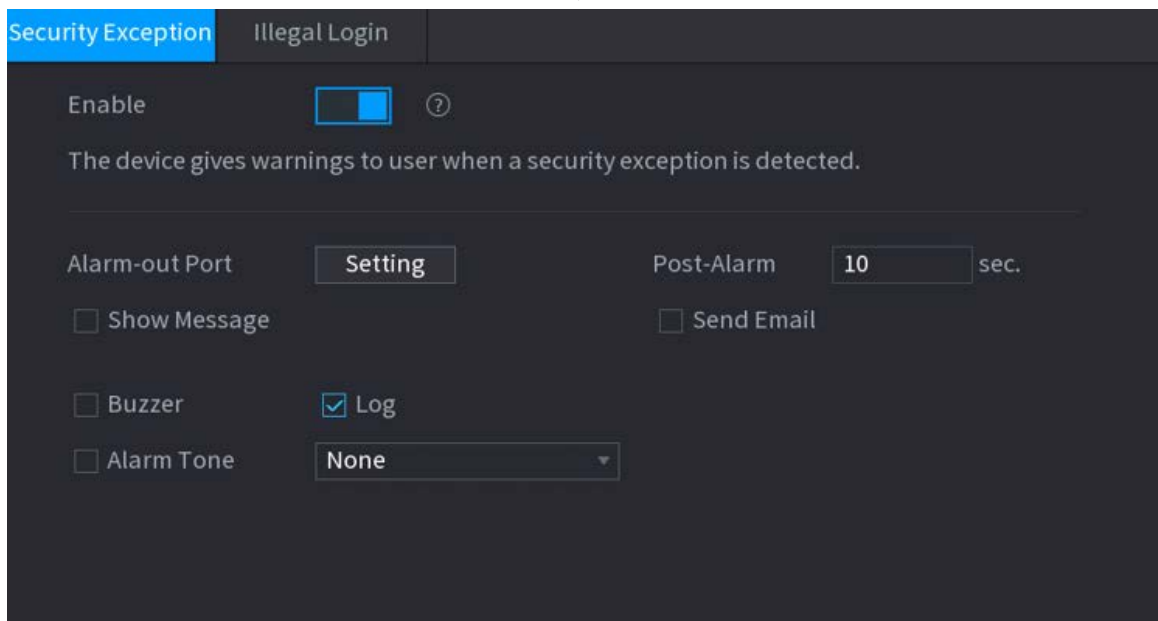

Step 2 Click  to enable the function.



Click  to view the list of security exception events.

Step 3 Configure alarm linkage actions. For details, see Step 7.

Step 4 Click **Apply**.

5.14.6.2 Illegal Login

Procedure

Step 1 Select **Main Menu > SECURITY > Security Warning > Illegal Login.**

Figure 5-253 Illegal login

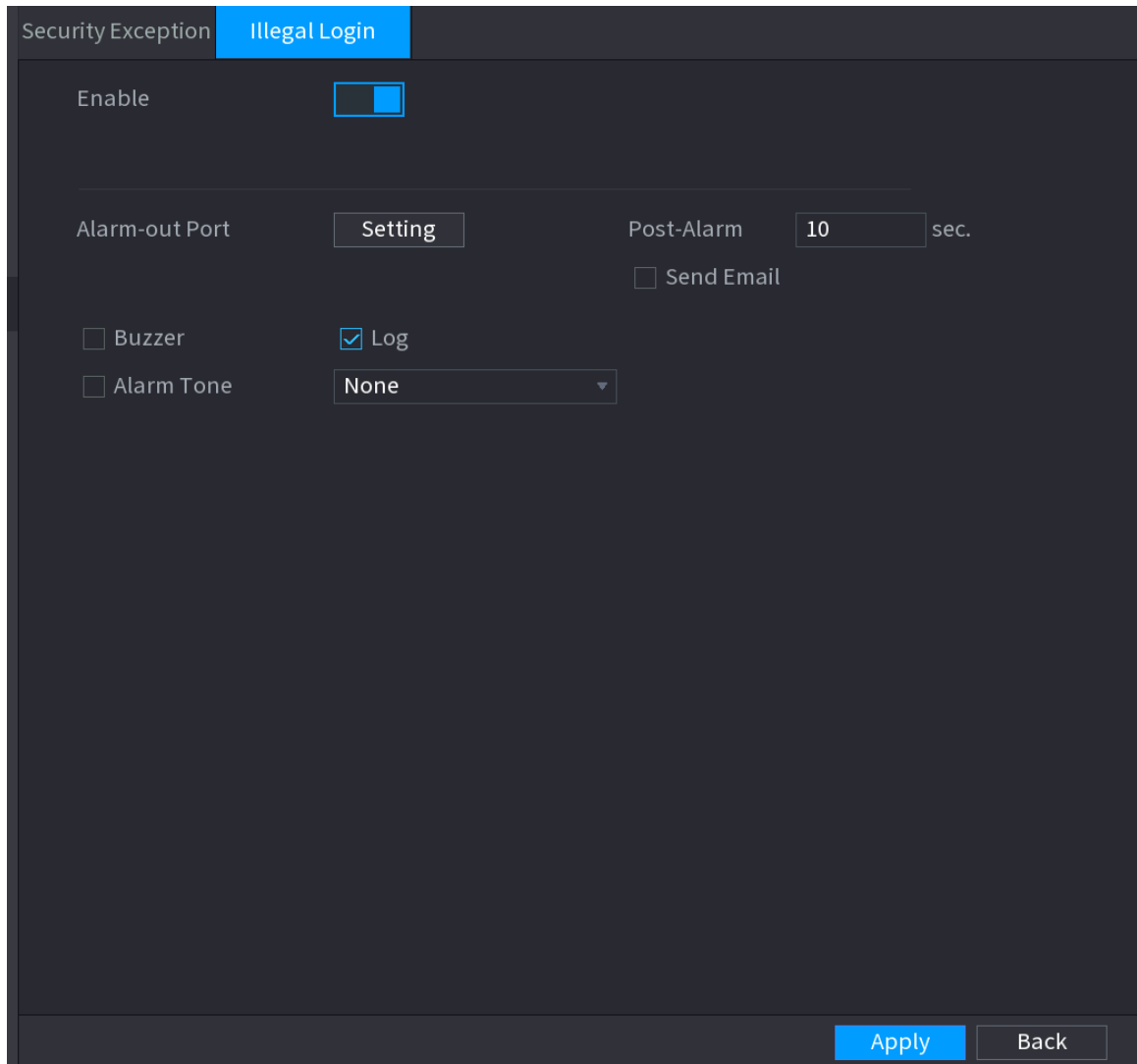

Security Exception | **Illegal Login**

Enable

Alarm-out Port Post-Alarm sec.

Send Email

Buzzer Log

Alarm Tone

Step 2 Click  to enable the function.

Step 3 Configure alarm linkage actions. For details, see [Step 7](#).

Step 4 Click **Apply**.

5.15 System

5.15.1 General Settings

You can set NVR basic information such as system date and holiday.

5.15.1.1 General

Background Information

You can set device basic information such as device name, and serial number.

Procedure

Step 1 Select **Main Menu > SYSTEM > General > Basic**.

Figure 5-254 Basic settings

The screenshot shows the 'Basic' settings page. The fields and their values are as follows:

- Device Name: NVR
- Device No.: 8
- Language: English
- Video Standard: PAL
- Sync Remote Device: (Include language, format and time zone)
- Instant Playback: 5 min.
- Logout Time: 10 min. (Non-login User Permission)
- CAM Time Sync:
- Interval: 24 hr. (1 - 168)
- Navigation Bar:
- Mouse Sensitivity: Slider between Slow and Fast

Buttons at the bottom right: Apply, Back

Step 2 Set parameters.

Table 5-75 Basic parameters

Parameter	Description
Device Name	Enter the Device name.
Device No.	Enter a number for the Device.
Language	Select a language for the Device system.
Video Standard	Select PAL or NTSC as needed.
Sync Remote Device	Enable this function; the NVR can synchronize information with the remote device such as Language, video standard and time zone.
Instant Playback	In the Instant Play box, enter the time length for playing back the recorded video. The value ranges from 5 to 60. On the live view control bar, click the instant playback button to play back the recorded video within the configured time.
Logout Time	Enter the standby time for the Device. The Device automatically logs out when it is not working in the configured period. You need to login the Device again. The value ranges from 0 to 60. 0 indicates there is not standby time for the Device. Click Monitor Channel(s) when logout . You can select the channels that you want to continue monitoring when you logged out.
CAM Time Sync	Syncs the Device time with IP camera.
Interval	Enter the interval for time sync.
Logout Time	You can set auto logout interval once login user remains inactive for a specified time. Value ranges from 0 to 60 minutes.

Parameter	Description
Navigation Bar	Enable the navigation bar. When you click on the live view screen, the navigation bar is displayed.
Mouse Sensitivity	Adjust the speed of double-click by moving the slider. The bigger the value is, the faster the speed is.

Step 3 Click **Apply** button to save settings.

5.15.1.2 Date and Time

Background Information

You can set device time. You can enable NTP (Network Time Protocol) function so that the device can sync time with the NTP server.

You can also configure date and time settings by selecting **Main Menu > SYSTEM > General > Date&Time**.

Procedure

Step 1 Click **Date&Time** tab.



Figure 5-255 Date and time

The screenshot displays the 'Date and Time' configuration page. It includes the following fields and controls:

- System Time:** 2020 -02 -24 09 :45 :02
- Time Zone:** (UTC+08:00) Beijing, Chongqing, Hong Kong, ... [Save]
- Date Format:** YYYY MM DD
- Date Separator:** -
- Time Format:** 24-Hour
- DST:** [Disabled]
- Type:** Date Week
- Start Time:** Jan 1 00 :00
- End Time:** Jan 2 00 :00
- NTP:** [Disabled]
- Server Address:** time.windows.com [Manual Update]
- Port:** 123
- Interval:** 60 min.

Step 2 Configure the settings for date and time parameters.

Table 5-76 Data and time parameters

Parameter	Description
System Time	<p>In the System Time box, enter time for the system.</p> <p>Click the time zone list, you can select a time zone for the system, and the time in adjust automatically.</p>  <p>Do not change the system time randomly; otherwise the recorded video cannot be searched. It is recommended to avoid the recording period or stop recording first before you change the system time.</p>
Time Zone	In the Time Zone list, select a time zone for the system.
Date Format	In the Date Format list, select a date format for the system.
Date Separator	In the Date Separator list, select a separator style for the date.
Time Format	In the Time Format list, select 12-HOUR or 24-HOUR for the time display style.
DST	Enable the Daylight Saving Time function. Click Week or Date .
Start Time	Configure the start time and end time for the DST.
End Time	
NTP	<p>Enable the NTP function to sync the Device time with the NTP server.</p>  <p>If NTP is enabled, device time will be automatically synchronized with server.</p>
Server Address	<p>In the Server Address box, enter the IP address or domain name of the corresponding NTP server.</p> <p>Click Manual Update, the Device starts syncing with the server immediately.</p>
Port	The system supports TCP protocol only and the default setting is 123.
Interval	In the Interval box, enter the amount of time that you want the Device to sync time with the NTP server. The value ranges from 0 to 65535.

Step 3 Click **Next** to save settings.

5.15.1.3 Holiday

Background Information

Here you can add, edit, and delete holiday. After you successfully set holiday information, you can view holiday item on the record and snapshot period.

You can also configure holiday settings by selecting **Main Menu > SYSTEM > General > Holiday**.

Procedure

Step 1 Click **Next**.

Figure 5-256 Holiday

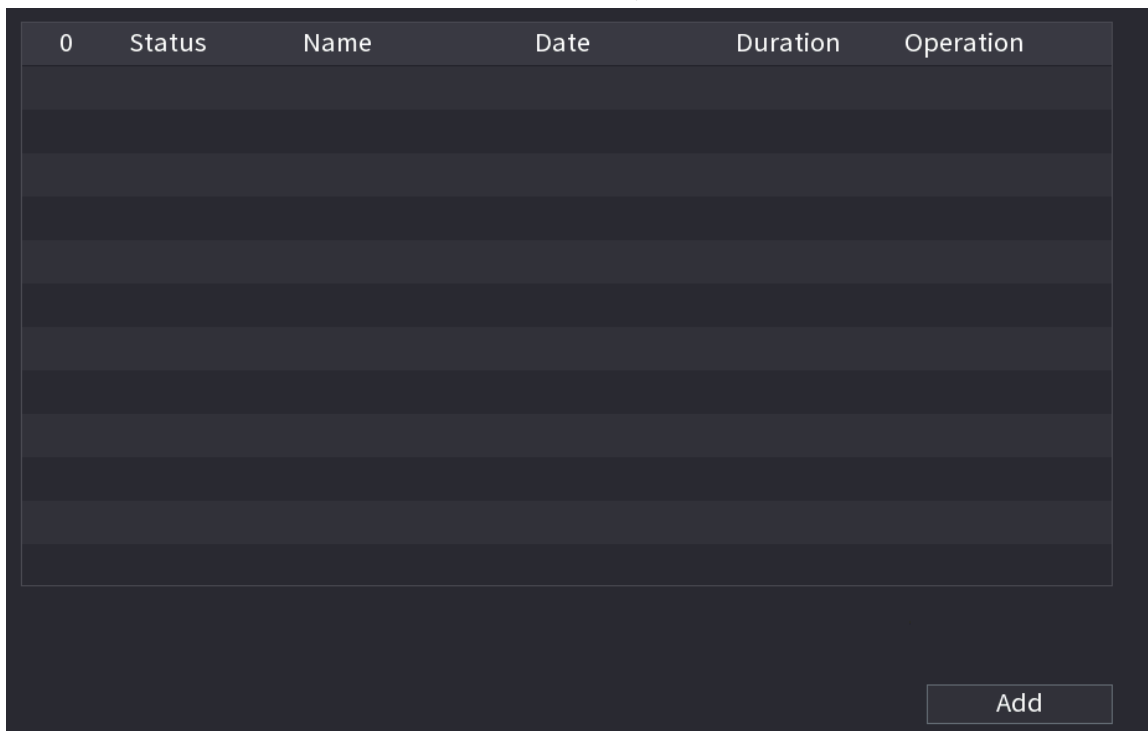

0	Status	Name	Date	Duration	Operation

Add

Step 2 Click **Add Holidays**.

Figure 5-257 Add holidays

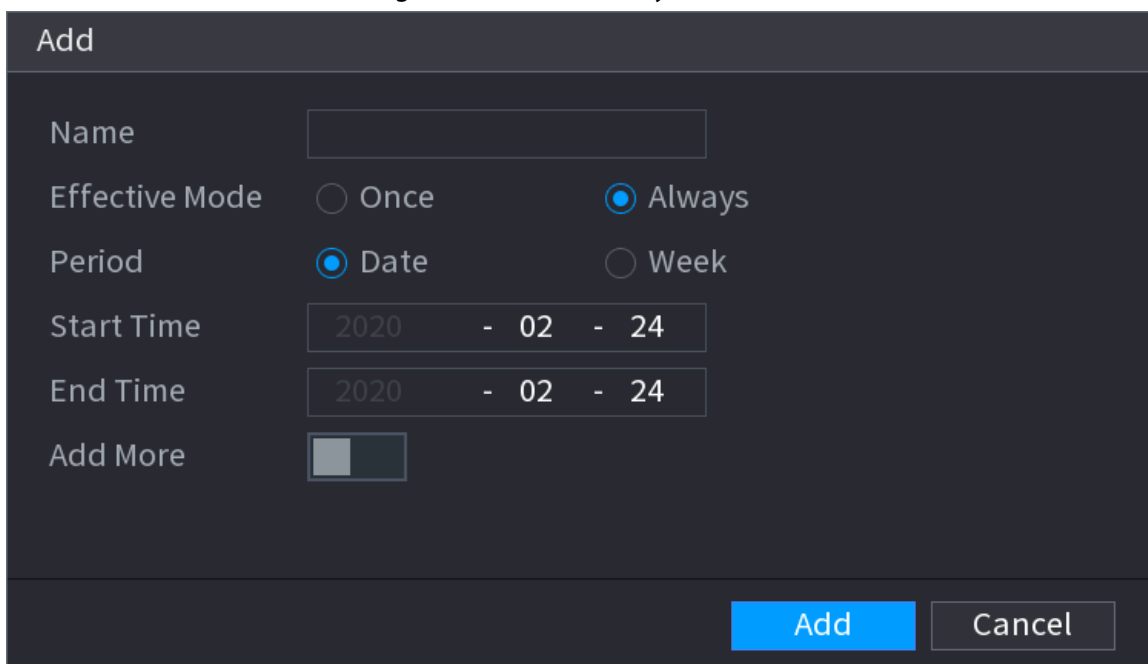

Add

Name

Effective Mode Once Always

Period Date Week

Start Time

End Time

Add More

Add Cancel

Step 3 Set holiday name, repeat mode and holiday mode.



Click **Add more** to add new holiday information.

Step 4 Click **Add**, you can add current holiday to the list.



- Click the drop-down list of the state; you can enable/disable holiday date.
- Click to change the holiday information. Click to delete current date.

Step 5 Click **Next** to save settings.

5.15.2 Serial Port

Background Information

After setting RS-232 parameters, the NVR can use the COM port to connect to other device to debug and operate.

Procedure

Step 1 Select **MAIN MENU > SYSTEM > Serial Port**.

Figure 5-258 Serial port

Function	Console
Baud Rate	115200
Data Bits	8
Stop Bits	1
Check	None

Step 2 Configure parameters.

Table 5-77 Serial port parameters

Parameter	Description
Function	Select serial port control protocol. <ul style="list-style-type: none"> • Console: Upgrade the program and debug with the console and mini terminal software. • Keyboard: Control this Device with special keyboard. • Adapter: Connect with PC directly for transparent transmission of data. • Protocol COM: Configure the function to protocol COM, in order to overlay card number. • PTZ Matrix: Connect matrix control Different series products support different RS-232 functions.
Baud Rate	Select baud rate, which is 115200 by default.

Parameter	Description
Data Bits	It ranges from 5 to 8, which is 8 by default.
Stop Bits	It includes 1 and 2.
Parity	It includes none, odd, even, mark and null.

Step 3 Click **Apply**.

5.16 Output and Display

5.16.1 Display

Background Information

You can configure the display effect such as displaying time title and channel title, adjusting image transparency, and selecting the resolution.

Procedure

Step 1 Select **Main Menu > DISPLAY > Display**.

Figure 5-259 Display

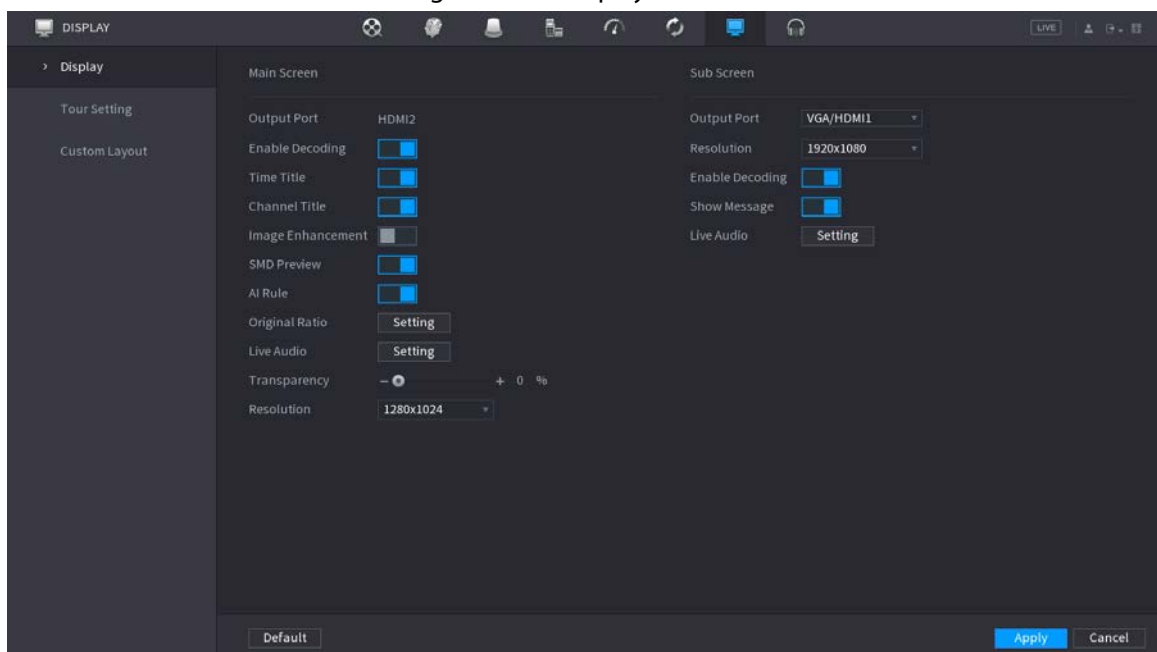

Step 2 Configure the parameters.

Table 5-78 Display parameters

Parameter	Description
Main Screen/Sub Screen	Configure the output port format of both screens. <ul style="list-style-type: none"> ● When sub screen is disabled, the format of main screen is HDMI/VGA simultaneous output. ● When sub screen is enabled, the format of main screen and sub screen are non-simultaneous outputs. <ul style="list-style-type: none"> ◇ When output port of sub screen is set to HDMI, the output port of main screen is set to VGA by the device. ◇ When output port of sub screen is set to VGA, the output port of main screen is set to HDMI by the device.
Enable Decoding	After it is enabled, the device can normally decode.
Time Title/Channel Title	Select the checkbox and the date and time of the system will be displayed in the preview screen.
Transparency	Set the transparency of the local menu of the NVR device. The higher the transparency, the more transparent the local menu.
Time Title/Channel Title	Select the checkbox and the date and time of the system will be displayed in the preview screen.
Image Enhancement	Select the checkbox to optimize the preview image edges.
SMD Preview	Select the checkbox to display the SMD previews in the live view interface.
AI Rule	Select the checkbox to display the AI rules in the live view interface.  This function is for some series products only.
Original Ratio	Click Setting and select the channel to restore the corresponding channel image to the original scale.
Live Audio	Configure audio input on live view. You can select Audio 1 , Audio 2 , and Mixing . For example, if you select Audio 1 for D1 channel, the sound of audio input port 1 of camera is playing. If you select Mixing , the sound of all audio input ports are playing.
Resolution	Support 1920×1080, 1280×1024(default), 1280×720.

Step 3 Click **Apply**.

5.16.2 Tour

Background Information

You can configure a tour of selected channels to repeat playing videos. The videos display in turn according to the channel group configured in tour settings. The system displays one channel group for a certain period and then automatically changes to the next channel group.

Procedure

Step 1 Select **DISPLAY > Tour Setting > Main Screen**.

Figure 5-260 Tour

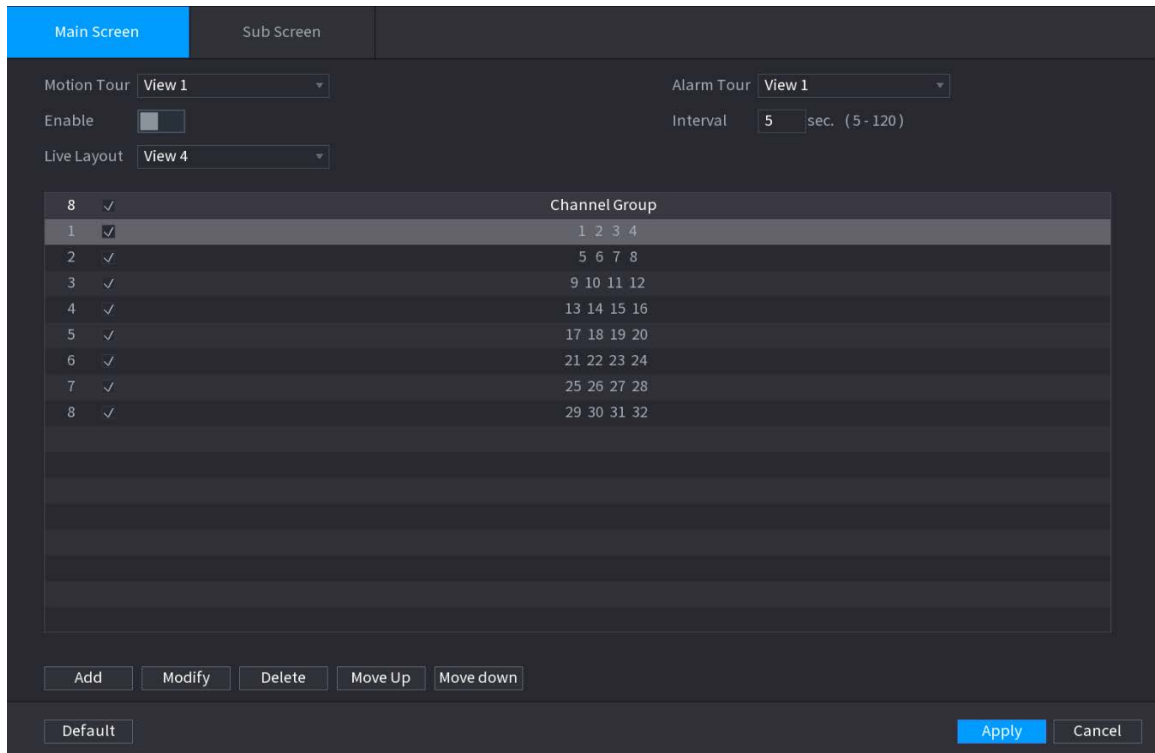

- On the top right of the live view screen, use the left mouse button or press Shift to switch between (image switching is allowed) and (image switching is not allowed) to turn on/off the tour function.
- On the navigation bar, click to enable the tour and click to disable it.

Step 2 Configure the tour setting parameters.

Table 5-79 Tour parameters

Parameter	Description
Enable Tour	Enable tour function.
Interval	Enter the amount of time that you want each channel group displays on the screen. The value ranges from 5 seconds to 120 seconds, and the default value is 5 seconds.
Motion Tour, Alarm Tour	Select the View 1 or View 8 for Motion Tour and Alarm Tour (system alarm events).
Live Layout	In the Live Layout list, select View 1 , View 4 , View 8 , or other modes that are supported by the Device.

Parameter	Description
Channel Group	Display all channel groups under the current Window Split setting. <ul style="list-style-type: none"> ● Add a channel group: Click Add, in the pop-up Add Group channel, select the channels to form a group, and then click Save. ● Delete a channel group: Select the checkbox of any channel group, and then click Delete. ● Edit a channel group: Select the checkbox of any channel group and then click Modify, or double-click on the group. The Modify Channel Group dialog box is displayed. You can regroup the channels. ● Click Move up or Move down to adjust the position of channel group.

Step 3 Click **Apply** to save the settings.

5.16.3 Custom Layout

Background Information

You can set customized video split mode.



- This function is for some series products. See the actual product for detailed information.
- Device max. supports 5 customized videos.

Procedure

Step 1 Select **Main Menu > DISPLAY > Custom Split**.

Figure 5-261 Custom split

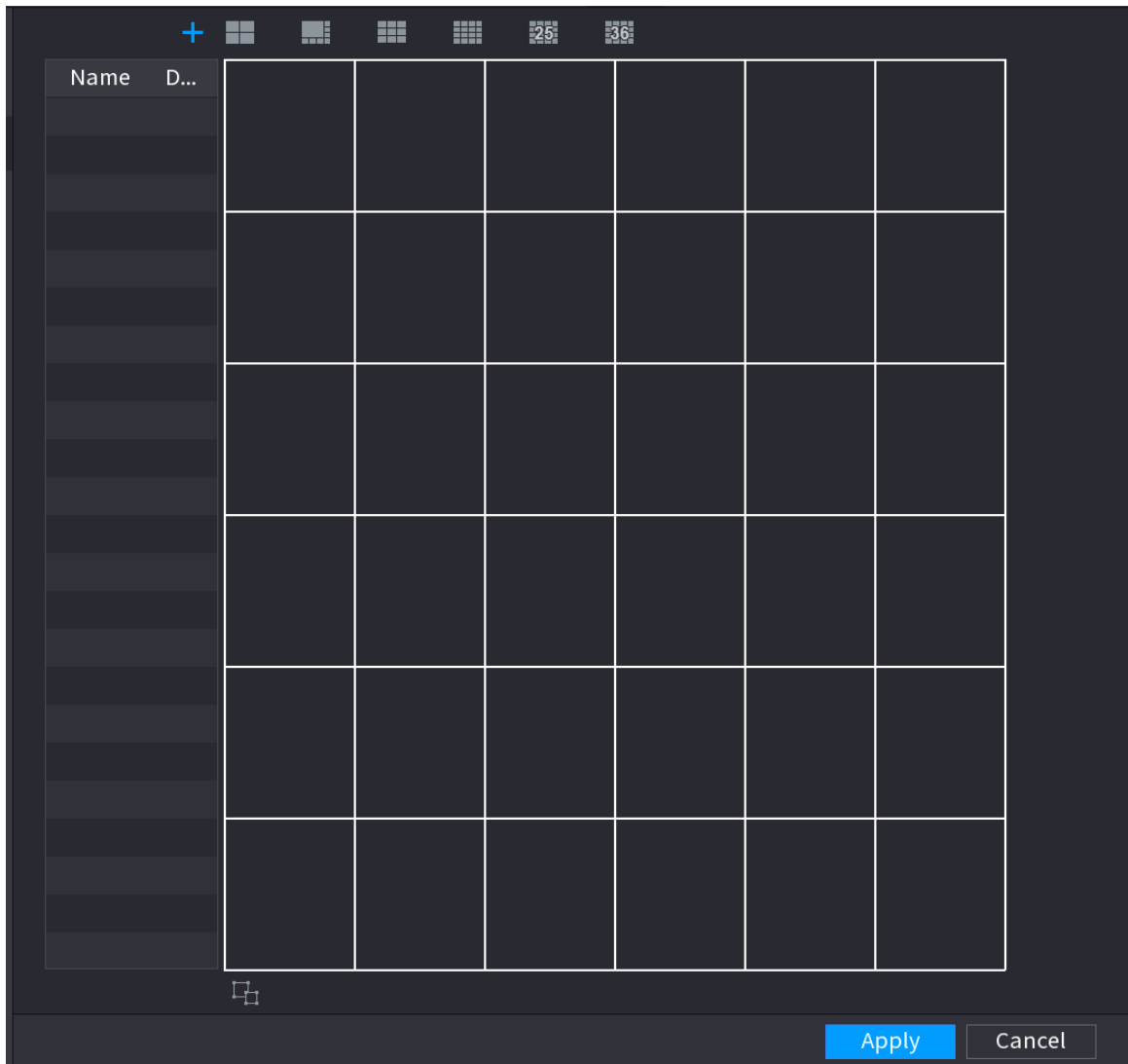

- Step 2** Click **+** and then click **[grid icons]** to select basic mode.
 System adopts the basic window mode as the new window name. For example, if you select the 8 display mode, the default name is Split8.
 In regular mode, drag the mouse in the preview frame; you can merge several small windows to one window so that you can get you desired split mode.



- After merge the window, system adopts the remaining window amount as the new name such as Split6.



- Select the window you want to merge (red highlighted), click  to cancel the merge to restore the basic mode.

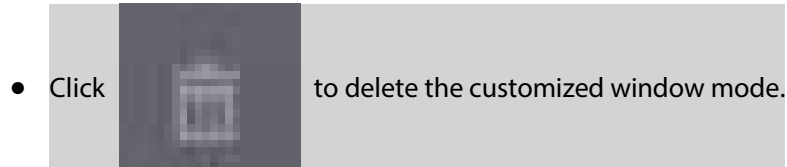

- Click  to delete the customized window mode.

Figure 5-262 Merged window

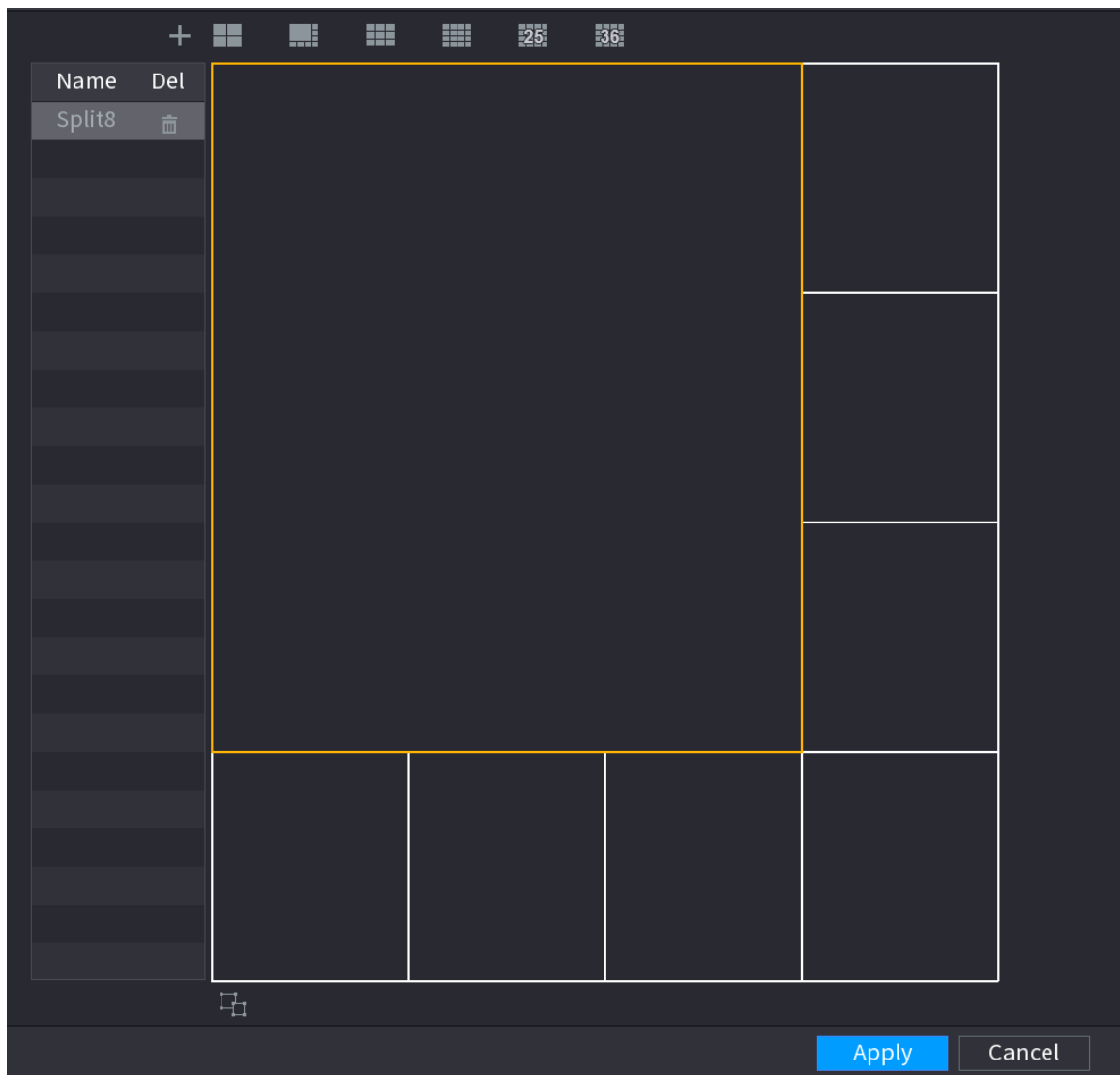

Step 3 Click **Apply** to exit.

After the setup, you can go to the preview window, right-click and then select **Live Layout** to select the custom split layout.

5.17 POS

You can connect the Device to the POS (Point of Sale) machine and receive the information from it. This function applies to the scenarios such as supermarket POS machine. After connection is established, the Device can access the POS information and display the overlaid text in the channel window.

5.17.1 Settings

Procedure

Step 1 Select **Main Menu > POS > POS Setting**.

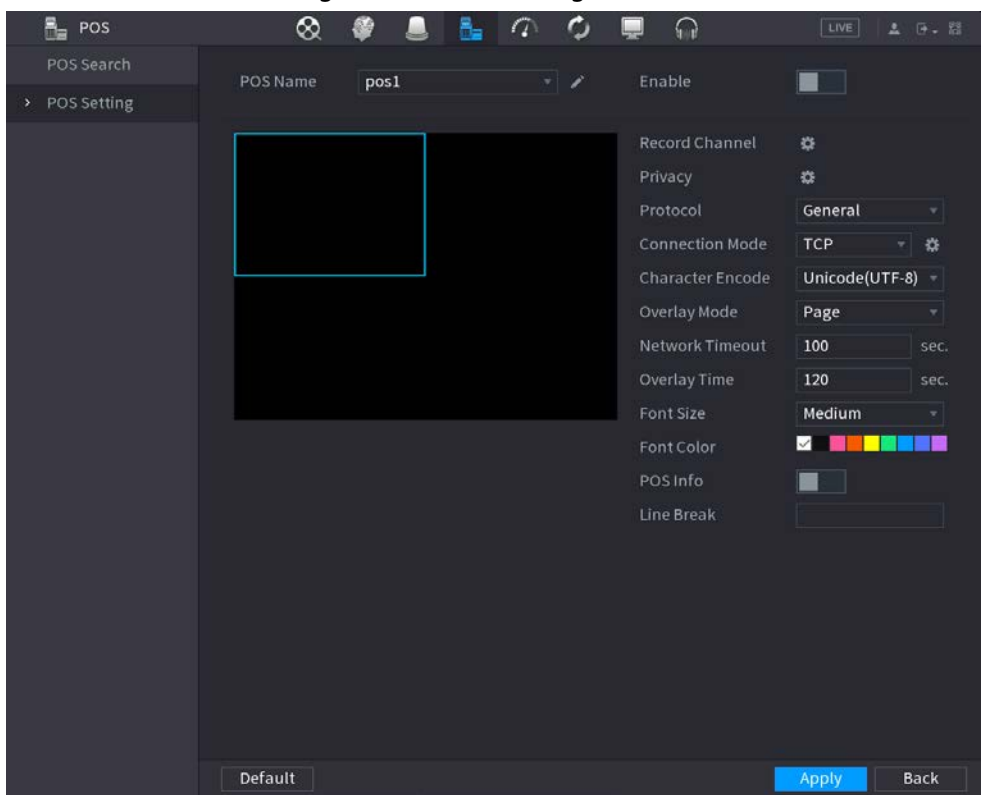

Figure 5-263 POS setting



Step 2 Configure the POS parameters.

Table 5-80 POS parameters

Parameter	Description
POS Name	<p>In the POS Name list, select the POS machine that you want to configures settings for. Click to modify the POS name.</p> <p></p> <ul style="list-style-type: none"> The POS name must be unique. You can enter up to 21 Chinese characters or 63 English characters.
Enable	Enable the POS function.
Record Channel	Click to select a channel to record.

Parameter	Description
Privacy	Enter the privacy contents.
Protocol	Select a protocol. Different machines correspond to different protocols.
Connection Mode	Select the connection protocol type. Click  , the IP Address window is displayed. In the Source IP box, enter the IP address (the machine that is connected to the Device) that sends messages.
Character Encode	Select a character encoding mode.
Overlay Mode	In the Overlay Mode list, Select Turn or ROLL . <ul style="list-style-type: none"> • Turn: Once the information is at 16 lines, system displays the next page. • ROLL: Once the information is at 16 lines, system rolls one line after another to delete the first line.  When the local preview mode is in 4-split, the turn/ROLL function is based on 8 lines.
Network time out	When the network is not working correctly and cannot be recovered after the entered timeout limit, the POS information will not display normally. After the network is recovered, the latest POS information will be displayed.
Time Display	Enter the time that how long you want to keep the POS information displaying. For example, enter 5, the POS information disappear from the screen after 5 seconds.
Font Size	Select Small , Medium , or Big as the text size of POS information
Font Color	In the color bar, click to select the color for the text size of POS information.
POS Info	Enable the POS Info function, the POS information displays in the live view/WEB.
Line Break	There is no line delimiter by default. After you set the line delimiter (HEX), the overlay information after the delimiter is displayed in the new line. For example, the line delimiter is F and the overlay information is 123F6789, NVR displays overlay information on the local preview interface and Web as: 123 6789

Step 3 Click **Apply**.

5.17.1.1 Privacy Setup

Procedure

Step 1 Click  next to **Privacy**.

Figure 5-264 Privacy

Step 2 Set privacy information.

Step 3 Click **OK**.

5.17.1.2 Connection Mode

Background Information

Connection type is UDP or TCP.

Procedure

Step 1 Select **Connection Mode** as **UDP**, **TCP_CLINET** or **TCP**.

Step 2 Click .

Figure 5-265 IP address

Step 3 For **Source IP** and **Port**, enter the POS IP address and port.

Step 4 Click **OK**.

5.17.2 Search

Background Information



The system supports fuzzy search.

Procedure

Step 1 Select **Main Menu > POS > POS Search**.

Figure 5-266 POS search

Step 2 In the **POS Search** box, enter the information such as transaction number on your receipt, amount, or product name.

Step 3 In the **Start Time** box and **End Time** box, enter the time period that you want to search the POS transaction information.

Step 4 Click **Search**.

The searched transaction results display in the table.

5.18 Audio

The audio function is to manage audio files and set schedule play function. It is to realize audio broadcast activation function.



This function is available on select models.

5.18.1 File Management

Background Information

You can add audio files, listen to audio files, rename and delete audio files, and configure the audio volume.

Procedure

Step 1 Select **Main Menu > AUDIO > File Management**.

Figure 5-267 File management

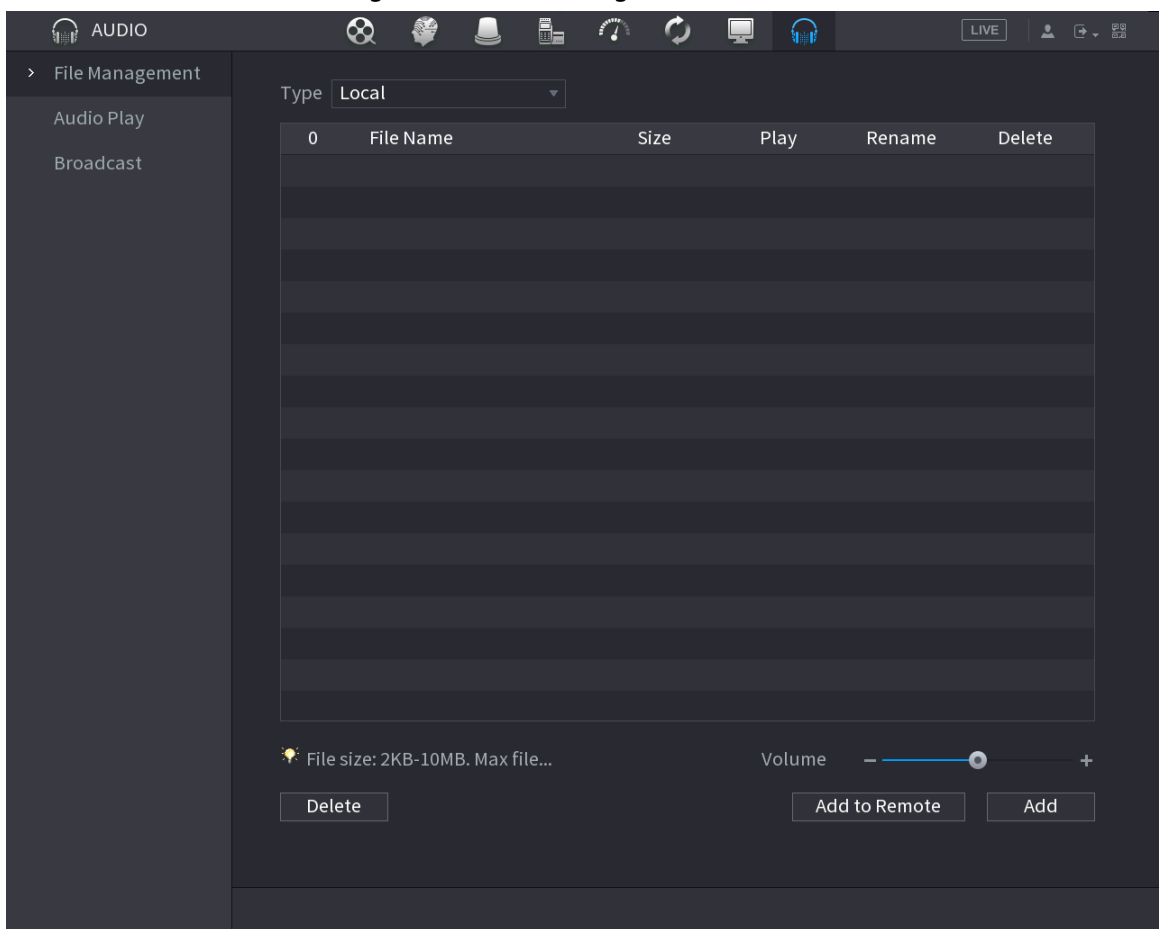

Step 2 Click **Add**.

Figure 5-268 Add file

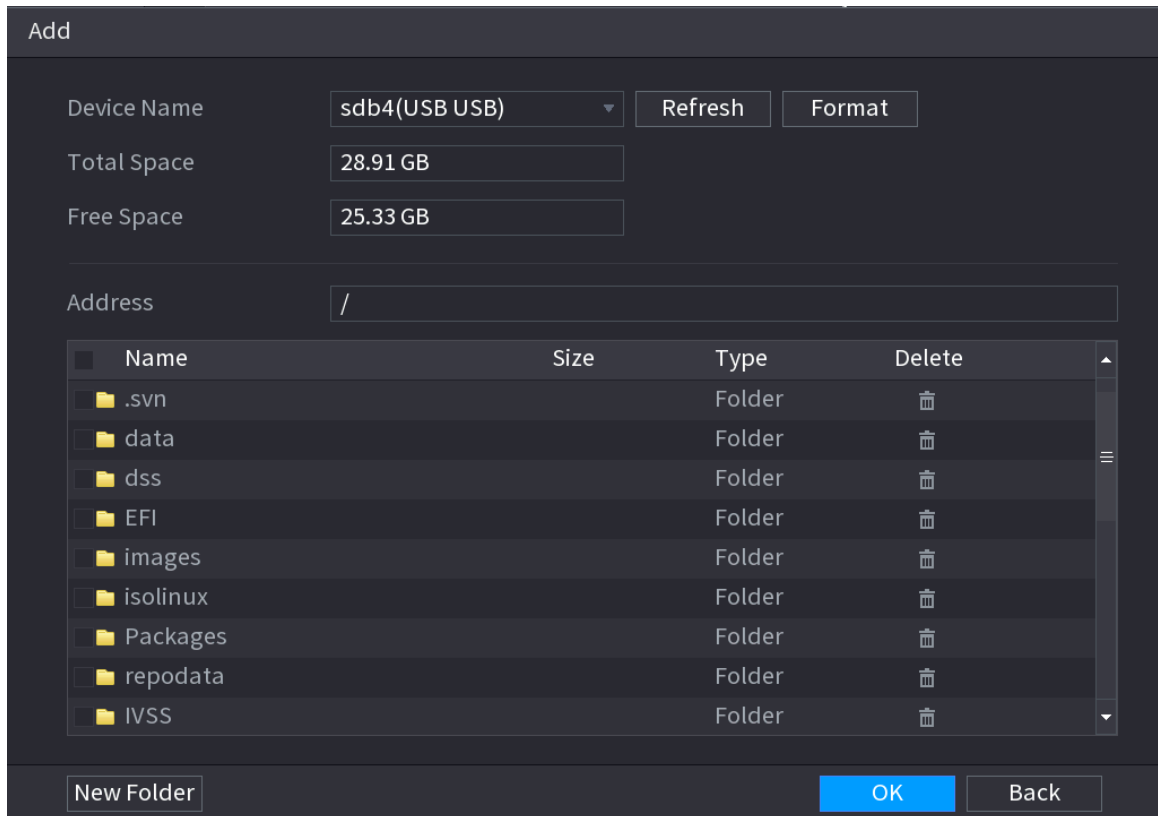

- Step 3** Select the audio file and then click **Import**.
System supports MP3 and PCM audio format.
- Step 4** Click **OK** to start importing audio files from the USB storage device.
If the importing is successful, the audio files will display in the **File Management** page.

5.18.2 Audio Play

Background Information

You can configure the settings to play the audio files during the defined time period.

Procedure

- Step 1** Select **Main Menu > AUDIO > Schedule**.

Figure 5-269 Schedule

Period	File Name	Interval	Loop	Outpu...
<input type="checkbox"/> 00 : 00 - 24 : 00	None	60 min.	0	Mic
<input type="checkbox"/> 00 : 00 - 24 : 00	None	60 min.	0	Mic
<input type="checkbox"/> 00 : 00 - 24 : 00	None	60 min.	0	Mic
<input type="checkbox"/> 00 : 00 - 24 : 00	None	60 min.	0	Mic
<input type="checkbox"/> 00 : 00 - 24 : 00	None	60 min.	0	Mic
<input type="checkbox"/> 00 : 00 - 24 : 00	None	60 min.	0	Mic

Step 2 Configure the parameters.

Table 5-81 Schedule parameters

Parameter	Description
Period	In the Period box, enter the time. Select the checkbox to enable the settings. You can configure up to six periods.
File Name	In the File Name list, select the audio file that you want to play for this configured period.
Interval	In the Interval box, enter the time in minutes for how often you want to repeat the playing.
Loop	Configure how many times you want to repeat the playing in the defined period.
Output	Includes two options: MIC and Audio. It is MIC by default. The MIC function shares the same port with talkback function and the latter has the priority.  Some series products do not have audio port.



- The finish time for audio playing depends on audio file size and the configured interval.
- Playing priority: Alarm event > Audio talk > Trial listening > Schedule audio file.

Step 3 Click **Apply**.

5.18.3 Broadcast

Background Information

System can broadcast to the camera, or broadcast to a channel group.

Procedure

Step 1 Select **Mani Menu > AUDIO > Broadcast**.

Figure 5-270 Broadcast



0	Group Name	Remarks	Modify	Delete

Add Group

Step 2 Click **Add Group**.

Figure 5-271 Add group (1)

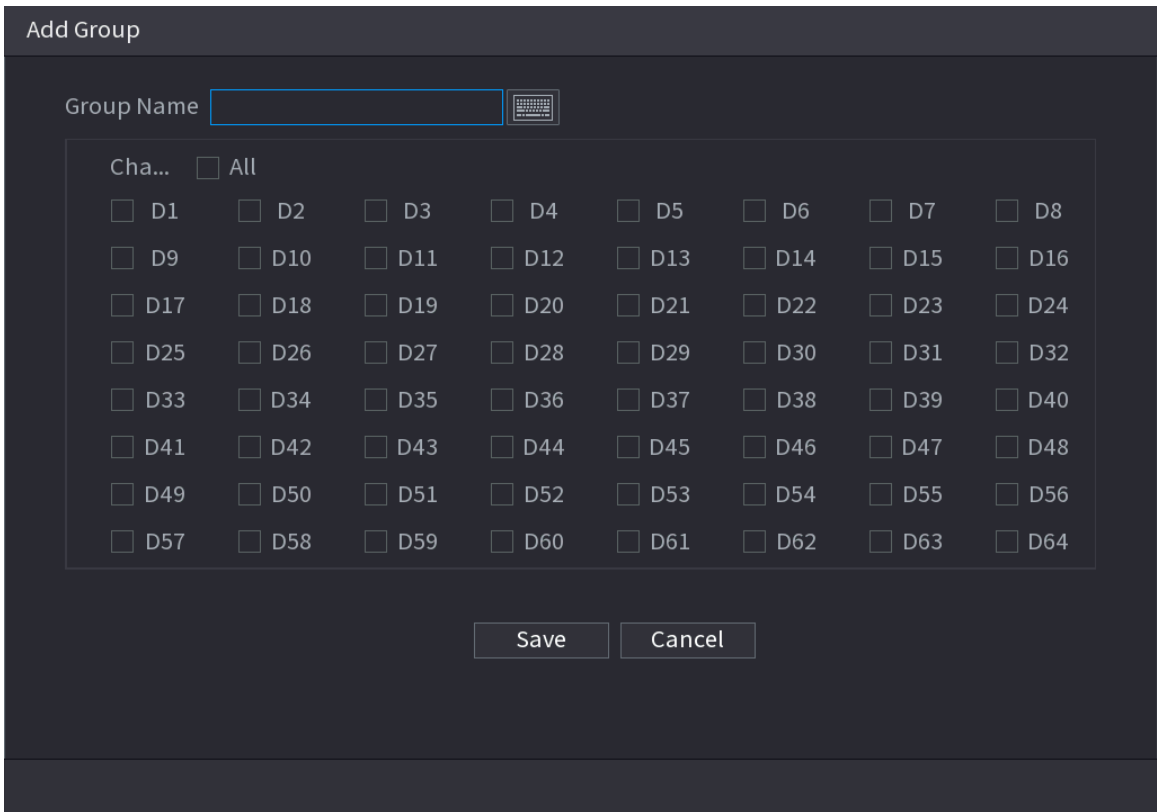

Add Group

Group Name

Cha... All

<input type="checkbox"/> D1	<input type="checkbox"/> D2	<input type="checkbox"/> D3	<input type="checkbox"/> D4	<input type="checkbox"/> D5	<input type="checkbox"/> D6	<input type="checkbox"/> D7	<input type="checkbox"/> D8
<input type="checkbox"/> D9	<input type="checkbox"/> D10	<input type="checkbox"/> D11	<input type="checkbox"/> D12	<input type="checkbox"/> D13	<input type="checkbox"/> D14	<input type="checkbox"/> D15	<input type="checkbox"/> D16
<input type="checkbox"/> D17	<input type="checkbox"/> D18	<input type="checkbox"/> D19	<input type="checkbox"/> D20	<input type="checkbox"/> D21	<input type="checkbox"/> D22	<input type="checkbox"/> D23	<input type="checkbox"/> D24
<input type="checkbox"/> D25	<input type="checkbox"/> D26	<input type="checkbox"/> D27	<input type="checkbox"/> D28	<input type="checkbox"/> D29	<input type="checkbox"/> D30	<input type="checkbox"/> D31	<input type="checkbox"/> D32
<input type="checkbox"/> D33	<input type="checkbox"/> D34	<input type="checkbox"/> D35	<input type="checkbox"/> D36	<input type="checkbox"/> D37	<input type="checkbox"/> D38	<input type="checkbox"/> D39	<input type="checkbox"/> D40
<input type="checkbox"/> D41	<input type="checkbox"/> D42	<input type="checkbox"/> D43	<input type="checkbox"/> D44	<input type="checkbox"/> D45	<input type="checkbox"/> D46	<input type="checkbox"/> D47	<input type="checkbox"/> D48
<input type="checkbox"/> D49	<input type="checkbox"/> D50	<input type="checkbox"/> D51	<input type="checkbox"/> D52	<input type="checkbox"/> D53	<input type="checkbox"/> D54	<input type="checkbox"/> D55	<input type="checkbox"/> D56
<input type="checkbox"/> D57	<input type="checkbox"/> D58	<input type="checkbox"/> D59	<input type="checkbox"/> D60	<input type="checkbox"/> D61	<input type="checkbox"/> D62	<input type="checkbox"/> D63	<input type="checkbox"/> D64

Save Cancel

Step 3 Input group name and select one or more channels.

Step 4 Click **Save** to complete broadcast group setup.







- On the broadcast interface, click  to change group setup, click  to delete group.
- After complete broadcast setup, on the preview interface and then click  on the navigation bar, device pops up broadcast dialogue box. Select a group name and then click  to begin broadcast.

Figure 5-272 Add group (2)



5.19 Operation and Maintenance

5.19.1 Log

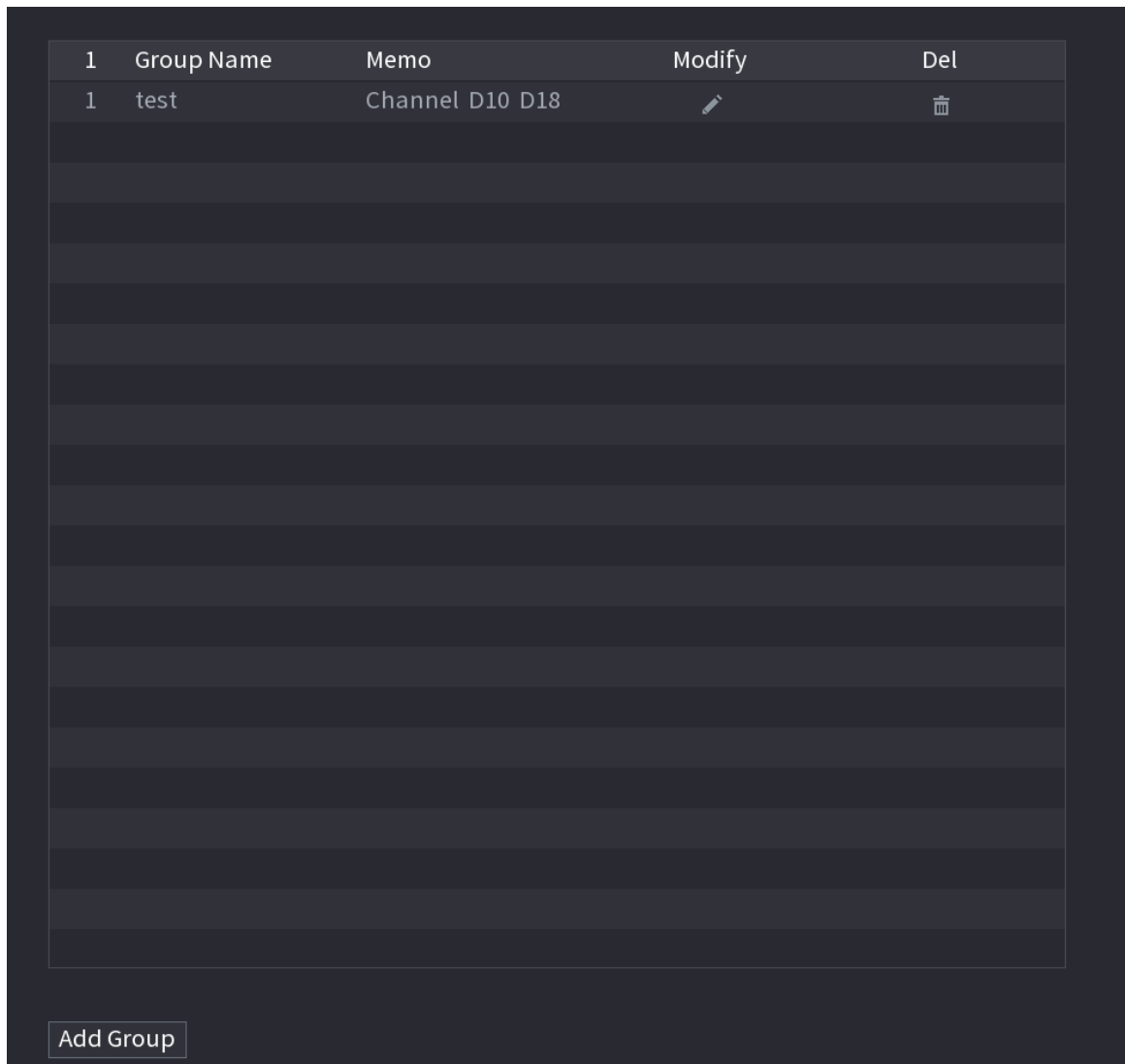
Background Information

You can view and search for the log information, or back up log to the USB device.

Procedure

Step 1 Select **Main Menu > MAINTAIN > Log**.

Figure 5-273 Log

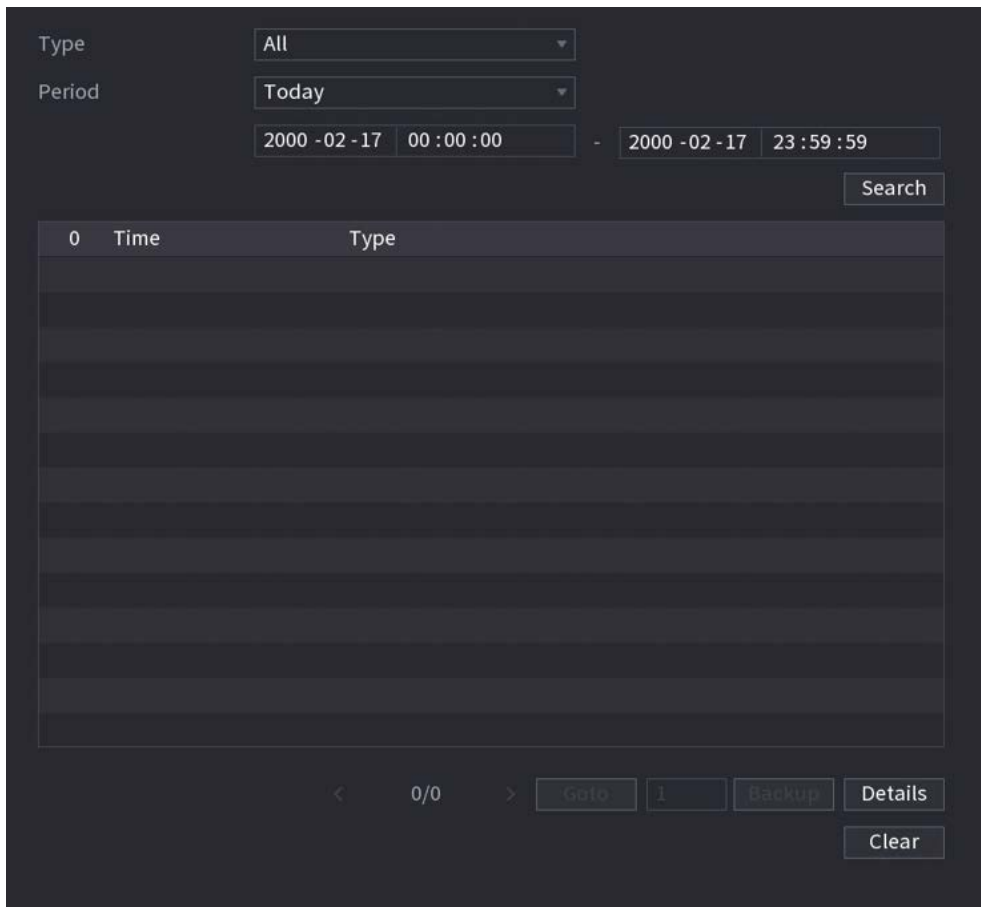

Step 2 In the **Type** list, select the log type that you want to view (**System, Config, Storage, Record, Account, Clear Log, Playback, and Connection**) or select **All** to view all logs.

Step 3 Enter the time period to search, and then click **Search**.
The search results are displayed.

Related Operations

- Click **Details** or double-click the log to view details. Click **Next** or **Previous** to view more log information.
- Click **Backup** to back up the logs to the USB storage device.
- Click **Clear** to remove all logs.

5.19.2 System

5.19.2.1 System Version

Select **Main Menu > MAINTAIN > System Info > Version**.
You can view NVR version information.

5.19.2.2 AI Algorithm Version

Select **Main Menu > MAINTAIN > System Info > Intelligent Algorithm**.

You can view version information for AI functions such as face detection, face recognition, IVS, and video metadata.

5.19.2.3 HDD Info

You can view the HDD quantity, HDD type, total space, free space, status, and S.M.A.R.T information.

Select **Main Menu > MAINTAIN > System Info > Disk**.

Figure 5-274 Disk information

No.	Device Name	Physical Position	Properties	Total Space	Free Space
All	-	-	-	2.71 TB	0.00 MB
1*	sda	Host-2	Read/Write	2.71 TB	0.00 MB

Table 5-82 Disk information

Parameter	Description
No.	Indicates the number of the currently connected HDD. The asterisk (*) means the current working HDD.
Device Name	Indicates name of HDD.
Physical Position	Indicates installation position of HDD.
Properties	Indicates HDD type.
Total Space	Indicates the total capacity of HDD.
Free Space	Indicates the usable capacity of HDD.
Health Status	Indicates the health status of the HDD.
S.M.A.R.T	View the S.M.A.R.T reports from HDD detecting.
Status	Indicates the status of the HDD to show if it is working normally.

5.19.2.4 BPS

You can view current video bit rate (kb/s) and resolution.

Select **Main Menu > MAINTAIN > System Info > BPS**.

Figure 5-275 BPS

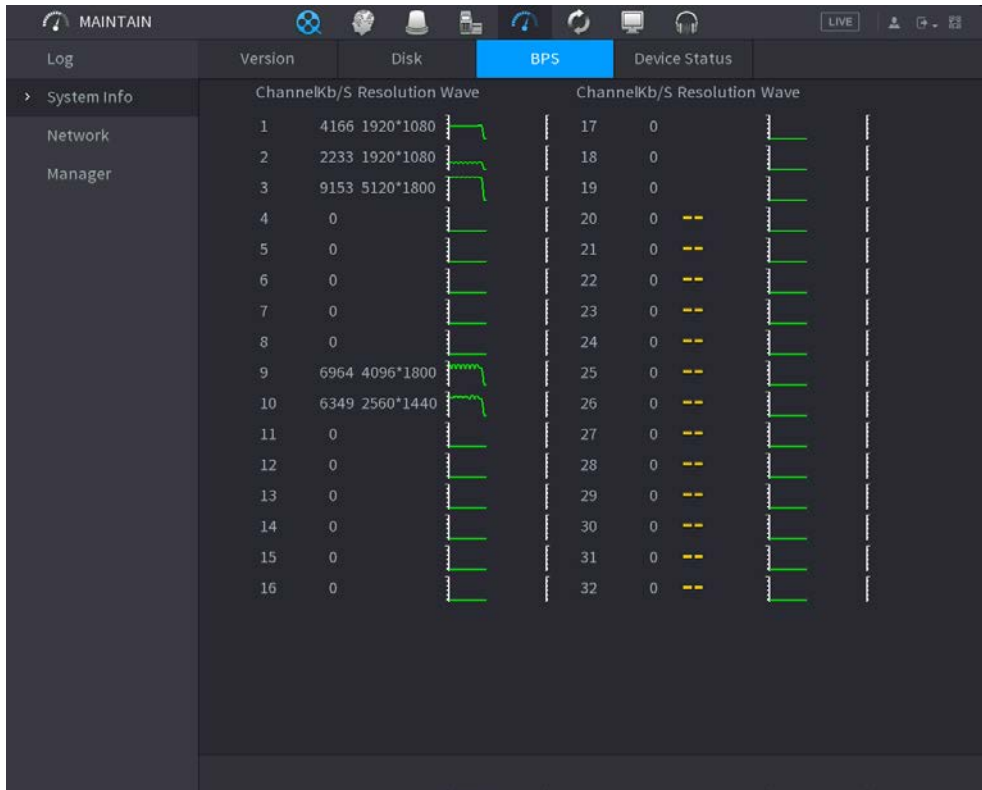

5.19.2.5 Device Status

You can view fan running status such as speed, CPU temperature, and memory.

Select **Main Menu > MAINTAIN > System Info > Device Status**.

Figure 5-276 Device status

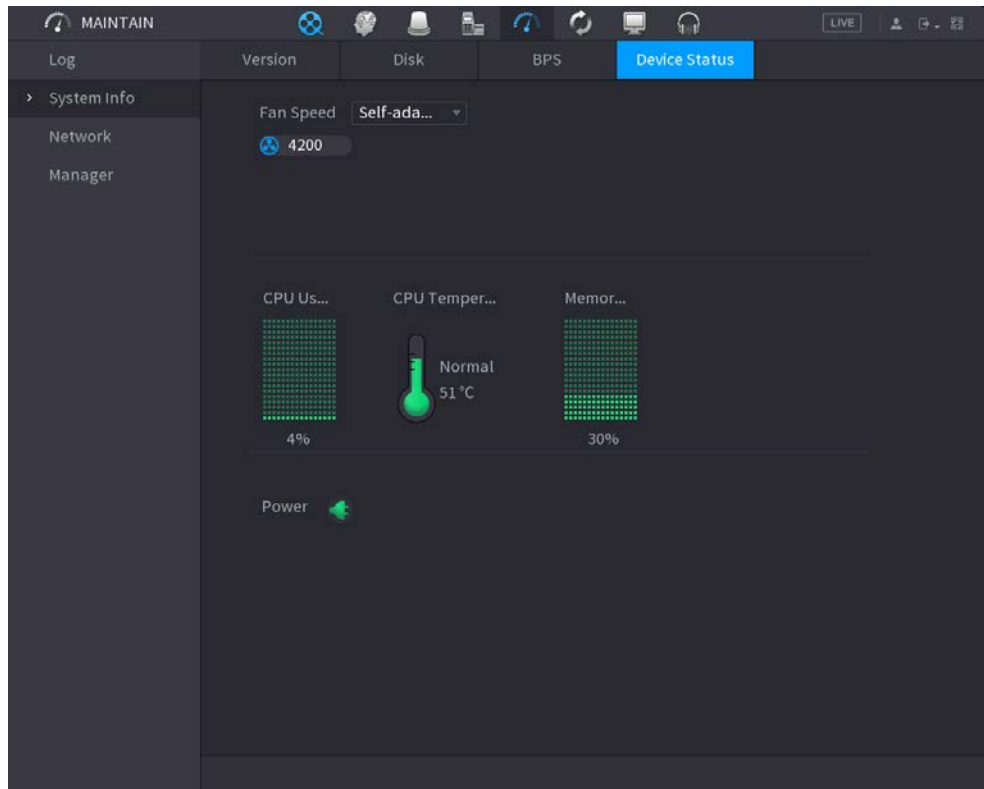

5.19.3 Network

5.19.3.1 Online User

You can view the online user information or block any user for a period of time. To block an online user, click  and then enter the time that you want to block this user. The maximum value you can set is 65535.

The system detects every 5 seconds to check whether there is any user added or deleted, and update the user list timely.

Select **Main Menu > MAINTAIN > Network > Online User**.

Figure 5-277 Online user

Username	IP Address	User Login Time	Blocked
admin	192.168.1.1	2020-02-23 14:02:08	

Blocked sec.

5.19.3.2 Network Load

Background Information

Network load means the data flow which measures the transmission capability. You can view the information such as data receiving speed and sending speed.

Procedure

Step 1 Select **Main Menu** > **MAINTAIN** > **Network** > **Network Load**.

Figure 5-278 Network load

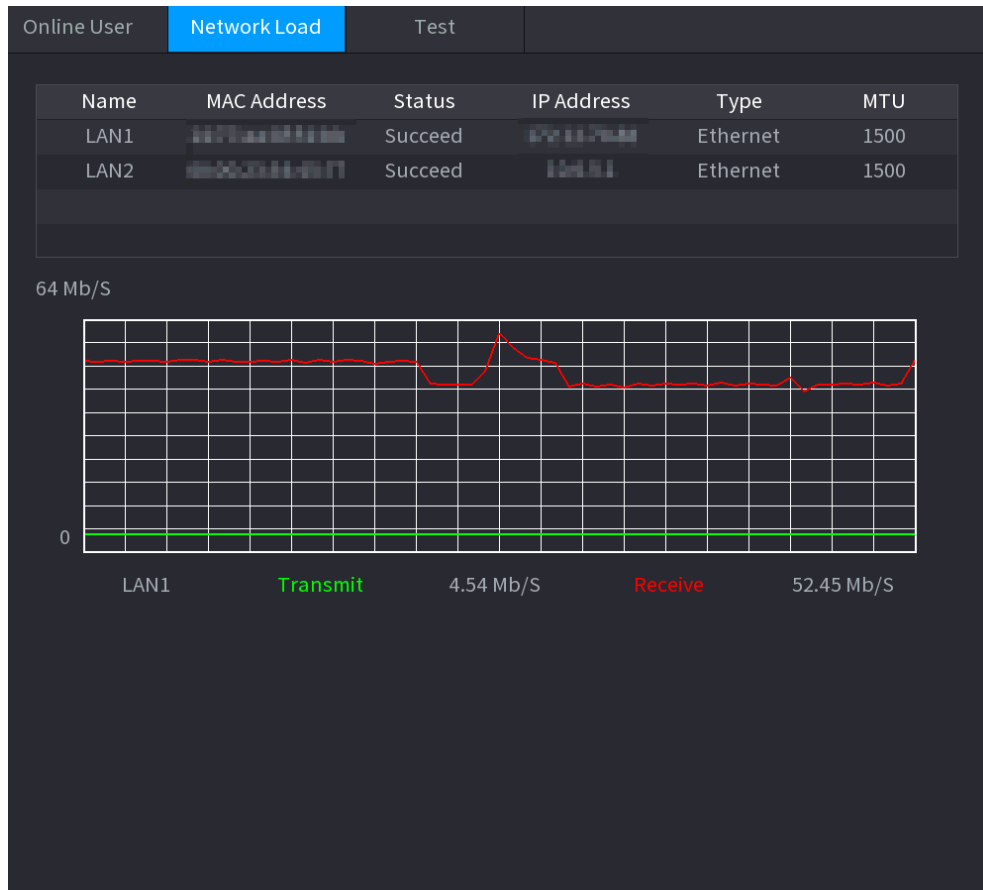

- Step 2** Click the LAN name that you want to view, for example, **LAN1**.
The system displays the information of data sending speed and receiving speed.



- System displays LAN1 load by default.
- Only one LAN load can be displayed at one time.

5.19.3.3 Network Test

Background Information

You can test the network connection status between the Device and other devices.

Procedure

- Step 1** Select **Main Menu > MAINTAIN > Network > Test**.

Figure 5-279 Test

Online User
Network Load
Test

Network Test

Destination IP Test

Test Result

Packet Sniffer Backup

Device Name Refresh

Address Browse

Name	IP	Packet Sniffer Size	Packet Sniffer Backup
LAN1	192.168.1.1	0KB	▶
LAN2	192.168.1.2	0KB	▶

Step 2 In the **Destination IP** box, enter the IP address.

Step 3 Click **Test**.

After testing is completed, the test result is displayed. You can check the evaluation for average delay, packet loss, and network status.

5.19.4 Maintenance and Management

5.19.4.1 Device Maintenance

Background Information

When the Device has been running for a long time, you can enable the Device to restart automatically at the idle time. You can also enable emergency maintenance.

Procedure

Step 1 Select **Main Menu > MAINTAIN > Manager > Maintenance**.

Figure 5-280 Maintenance

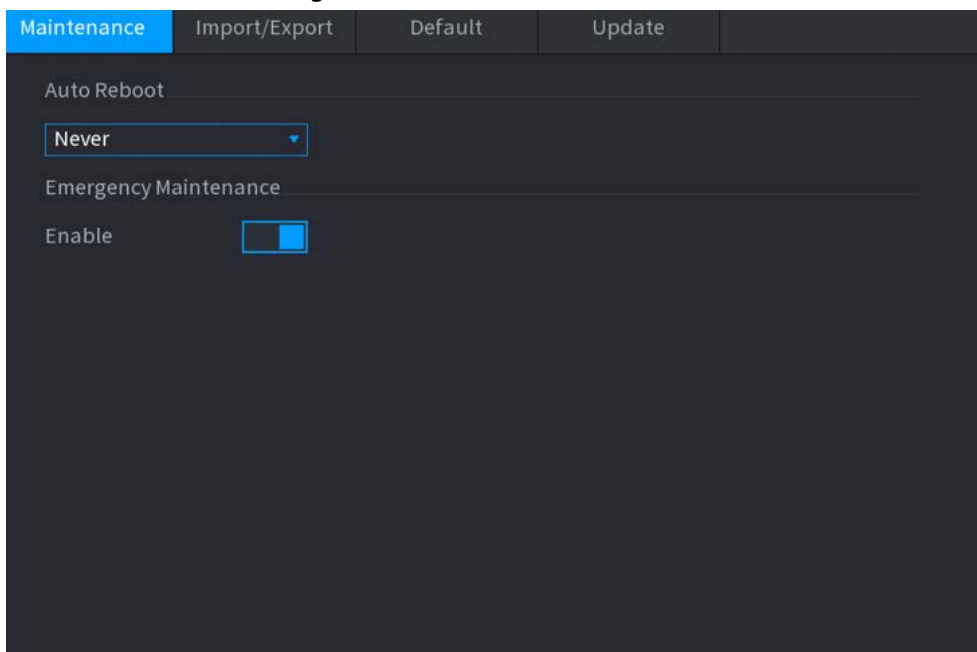

Step 2 Configure the parameters.

- **Auto Reboot:** Enable the Device to restart at the idle time.
- **Emergency Maintenance:** When the Device has an update power outage, running error and other problems, and you cannot log in, then you can use the emergency maintenance function to restart the Device, clear configuration, update the system, and more.

Step 3 Click **Apply**.

5.19.4.2 Exporting System Settings

Background Information

You can export or import the Device system settings if there are several Devices that require the same setup.



- The **Import/Export** interface cannot be opened if the backup operation is ongoing on the other interfaces.
- When you open the **Import/Export** interface, the system refreshes the devices and sets the current directory as the first root directory.
- Click **Format** to format the USB storage device.

Procedure

Step 1 Select **Main Menu > MAINTAIN > Manager > Import/Export**.

Figure 5-281 Import and export

Name	Size	Type	Delete
------	------	------	--------

Imported configuration will overwrite previous configuration.

Step 2 Insert a USB storage device into one of the USB ports on the Device.

Step 3 Click **Refresh** to refresh the interface.

The connected USB storage device is displayed.

Figure 5-282 Connected USB device

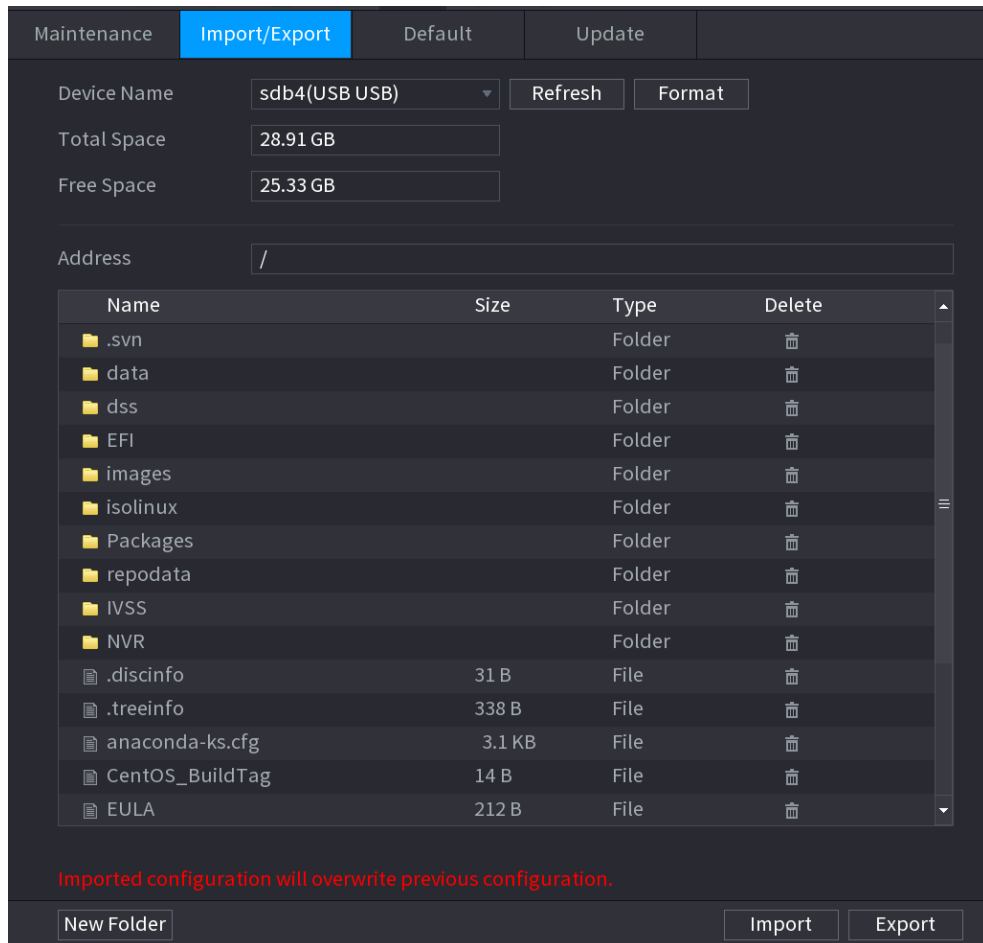

Step 4 Click **Export**.

There is a folder under the name style of "Config_xxxx". Double-click this folder to view the backup files.

5.19.4.3 Restoring Defaults

5.19.4.3.1 Restoring Defaults on the Local Interface

Background Information



This function is for admin account only.

You can restore the Device to default settings on the local interface.

Procedure

Step 1 Select **Main Menu > MAINTAIN > Manager > Default**.

Figure 5-283 Default

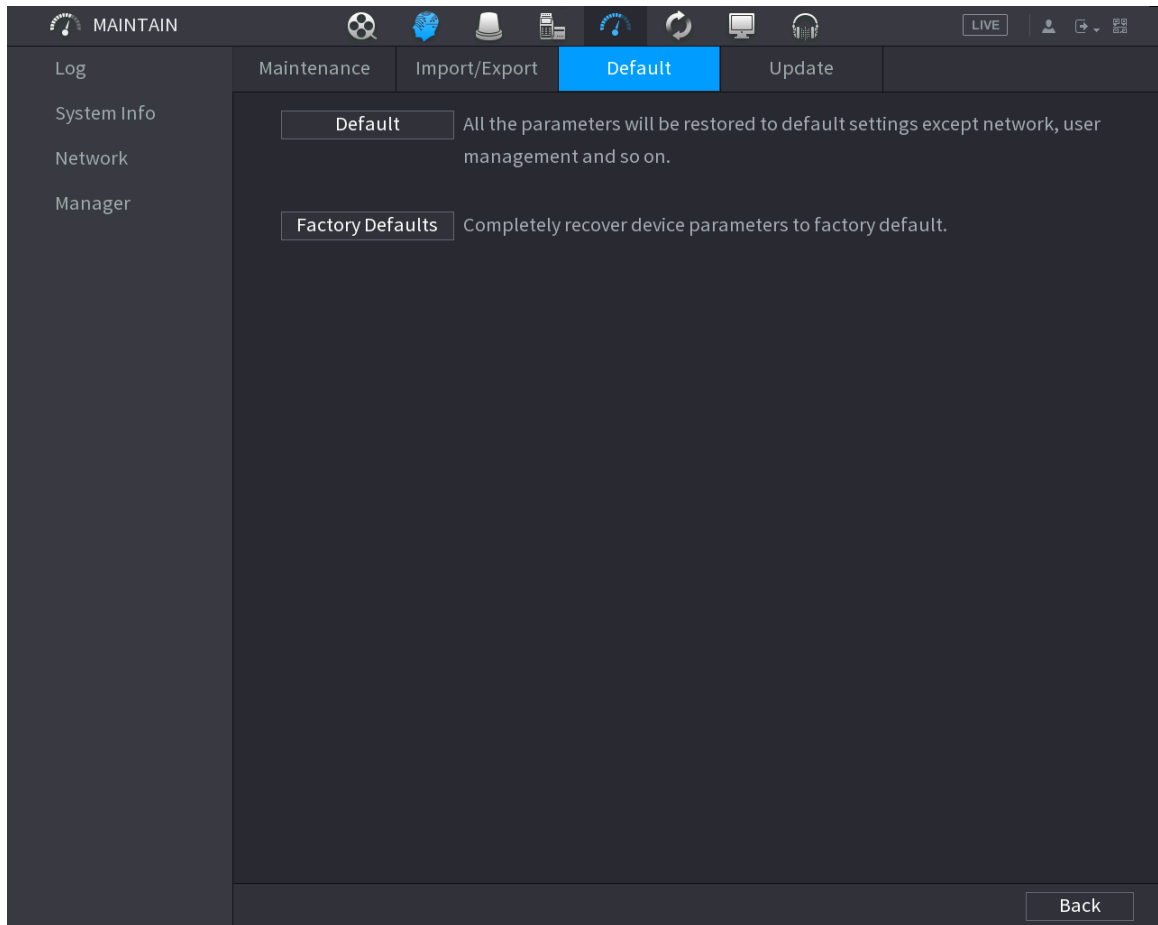

Step 2 Restore the settings.

- **Default:** Restore all the configurations except network settings and user management to the default..
- **Factory Default:** Restore all the configurations to the factory default settings.

5.19.4.3.2 Resetting Device through the Reset Button

Background Information

You can use the reset button on the mainboard to reset the Device to the factory default settings.



The reset button is available on select models.



After resetting, all the configurations will be lost.

Procedure

- Step 1** Disconnect the Device from power source, and then remove the cover panel. For details about removing the cover panel, see "3.3 HDD Installation".
- Step 2** Find the reset button on the mainboard, and then connect the Device to the power source again.
- Step 3** Press and hold the reset button for 5 seconds to 10 seconds.

Figure 5-284 Reset button



- Step 4** Restart the Device.
After the Device restarts, the settings have been restored to the factory default.

5.19.4.4 System Update

5.19.4.4.1 Upgrading File

Procedure

- Step 1** Insert a USB storage device containing the upgrade files into the USB port of the Device.
Step 2 Select **Main Menu > MAINTAIN > Manager > Update**

Figure 5-285 Update

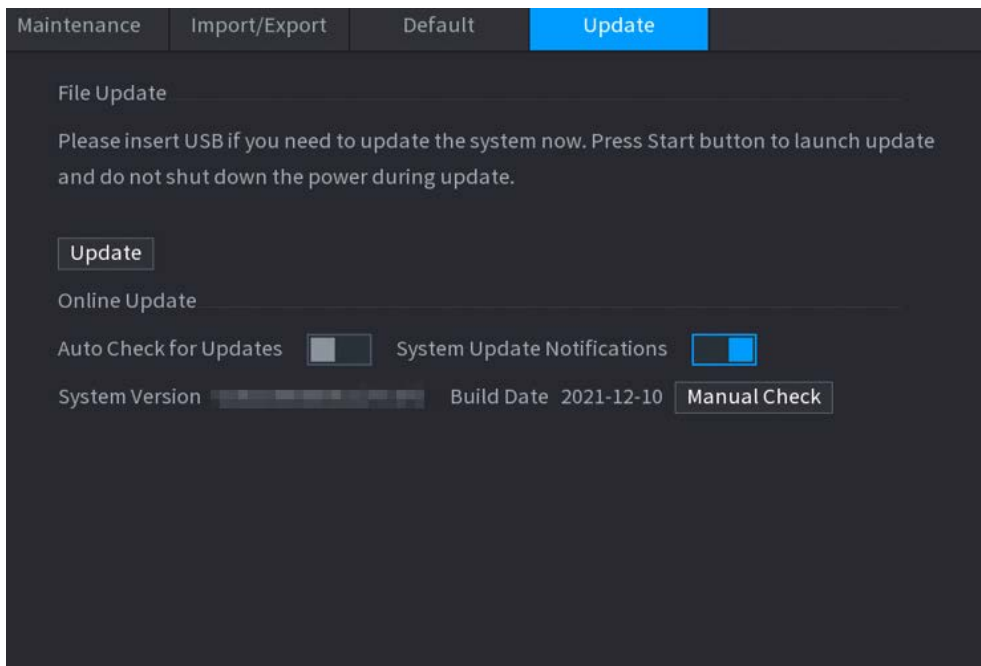

- Step 3** Click **Update**.

Figure 5-286 Browse

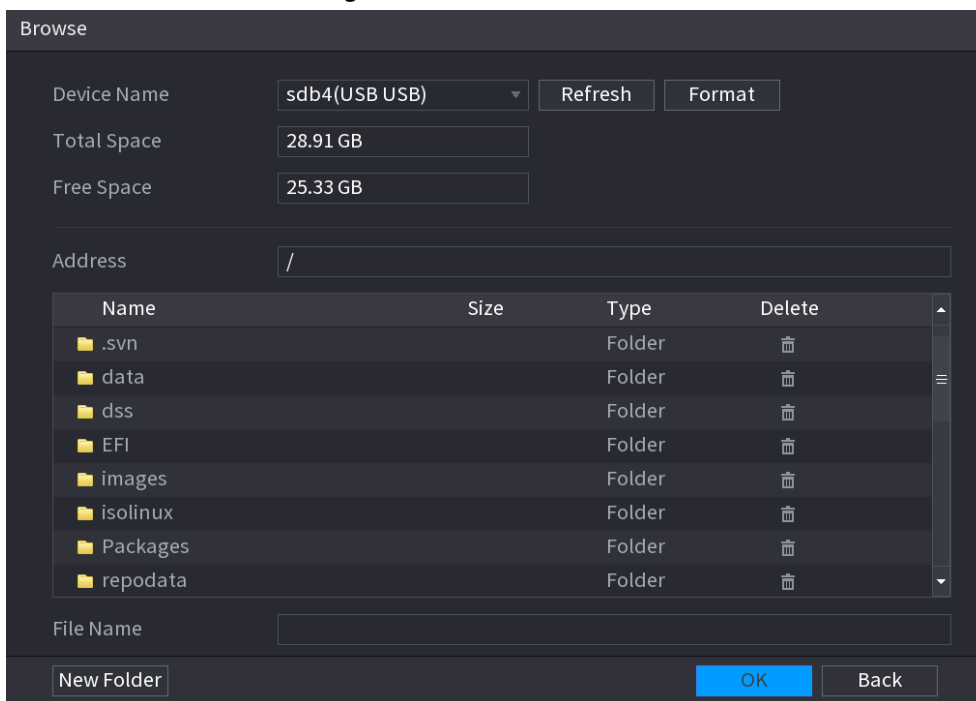

- Step 4** Click the file that you want to upgrade.
- Step 5** The selected file is displayed in the **Update File** box.
- Step 6** Click **Start**.

5.19.4.4.2 Online Upgrade

Background Information

When the Device is connected to Internet, you can use online upgrade function to upgrade the system.

Before using this function, you need to check whether there is any new version by auto check or manual check.

- Auto check: The Device checks if there is any new version available at intervals.
- Manual check: Perform real-time check whether there is any new version available.



Ensure the correct power supply and network connection during upgrading; otherwise the upgrading might be failed.

Procedure

Step 1 Select **Main Menu > MAINTAIN > Manager > Update**.

Step 2 Check whether there is any new version available.

- Auto-check for updates: Enable Auto-check for updates.
- Manual check: Click **Manual Check**.

The system starts checking the new versions. After checking is completed, the check result is displayed.

- If the "It is the latest version" text is displayed, you do not need to upgrade.
- If the text indicating there is a new version, go to the step 3.

Step 3 Click **Update now** to update the system.

5.19.4.4.3 Uboot Upgrading



- Under the root directory in the USB storage device, there must be "u-boot.bin.img" file and "update.img" file saved, and the USB storage device must be in FAT32 format.
- Make sure the USB storage device is inserted; otherwise the upgrading cannot be performed.

When starting the Device, the system automatically checks whether there is a USB storage device connected and any upgrade file, and if yes and the check result of the upgrade file is correct, the system will upgrade automatically. The Uboot upgrade can avoid the situation that you have to upgrade through +TFTP when the Device is halted.

5.19.4.5 Intelligent Diagnosis

Background Information

When exception occurs, export data to check details.

Select **Maintain > Intelligent Diagnosis**.

Figure 5-287 Intelligent diagnosis

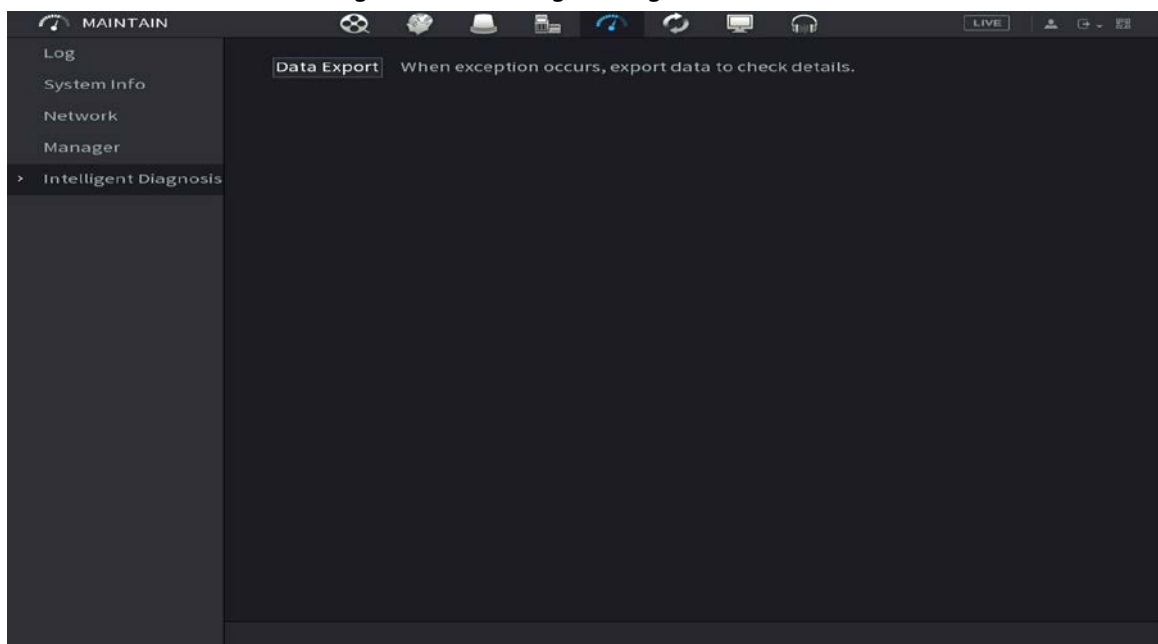

5.20 USB Device Auto Pop-up

After you inserted the USB device, system can auto detect it and pop up the following dialogue box. It allows you to conveniently backup file, log, configuration or update system.



You can add a USB keyboard through USB port, and it can input characters limited to soft keyboard.

Figure 5-288 USB device prompt

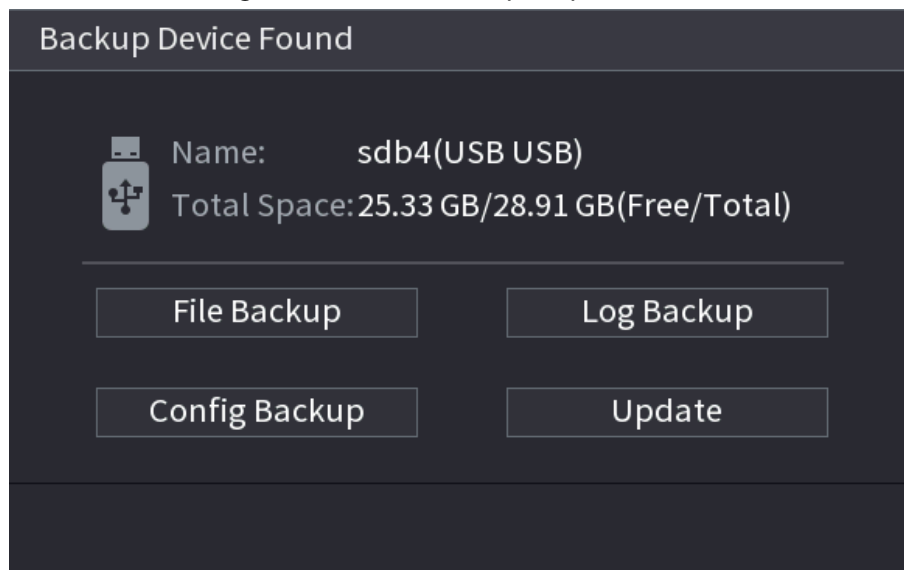

5.21 Shutdown



- When you see corresponding dialogue box "System is shutting down..." Do not click power on-off button directly.
- Do not unplug the power cable or click power on-off button to shutdown device directly when device is running (especially when it is recording.)
- Shut down the device and then unplug the power cable before you replace the HDD.

Procedure

- From the main menu (Recommended)
 1. Click  at the upper-right corner.

Figure 5-289 Shutdown (1)



2. Select **Shutdown**.

Draw the unlock pattern or input password first if you have no authority to shut down.

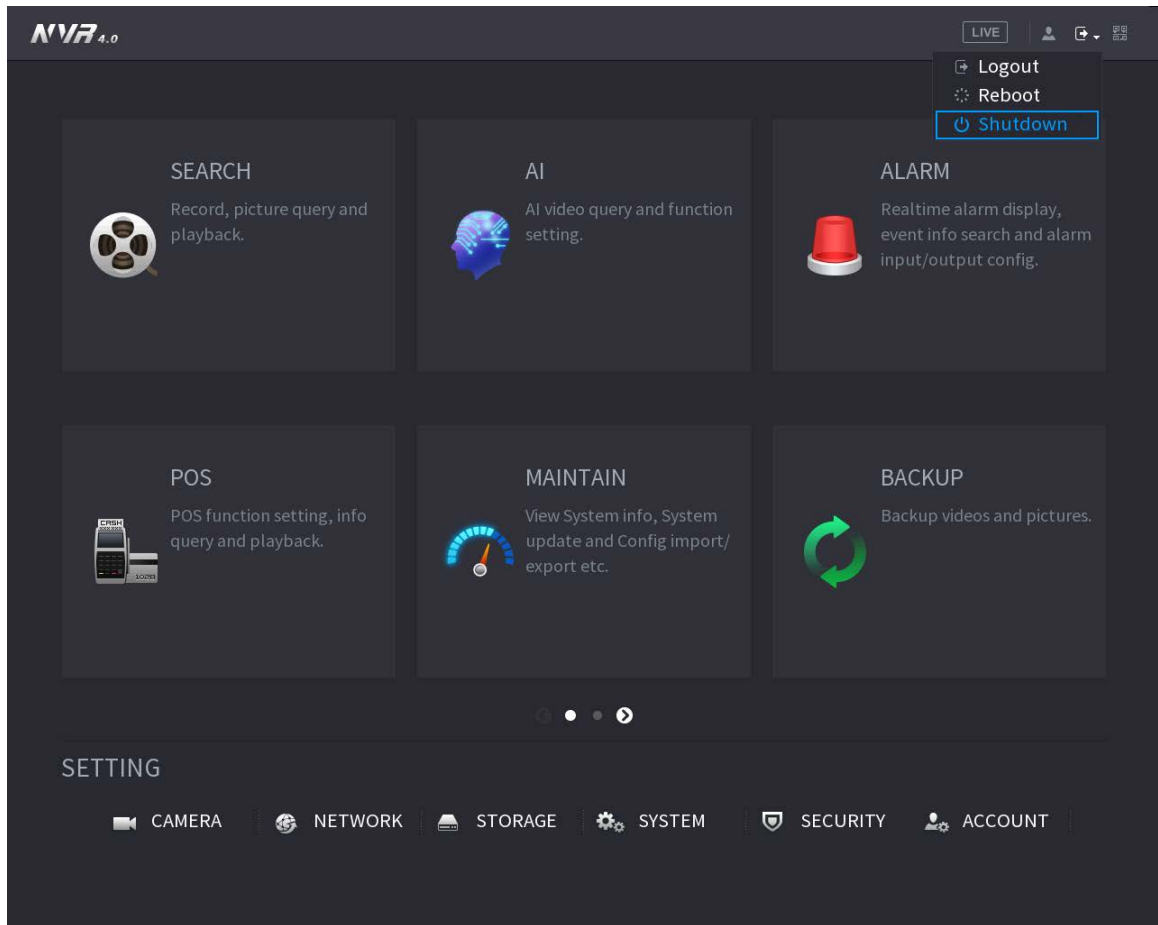
Figure 5-290 Shutdown (2)

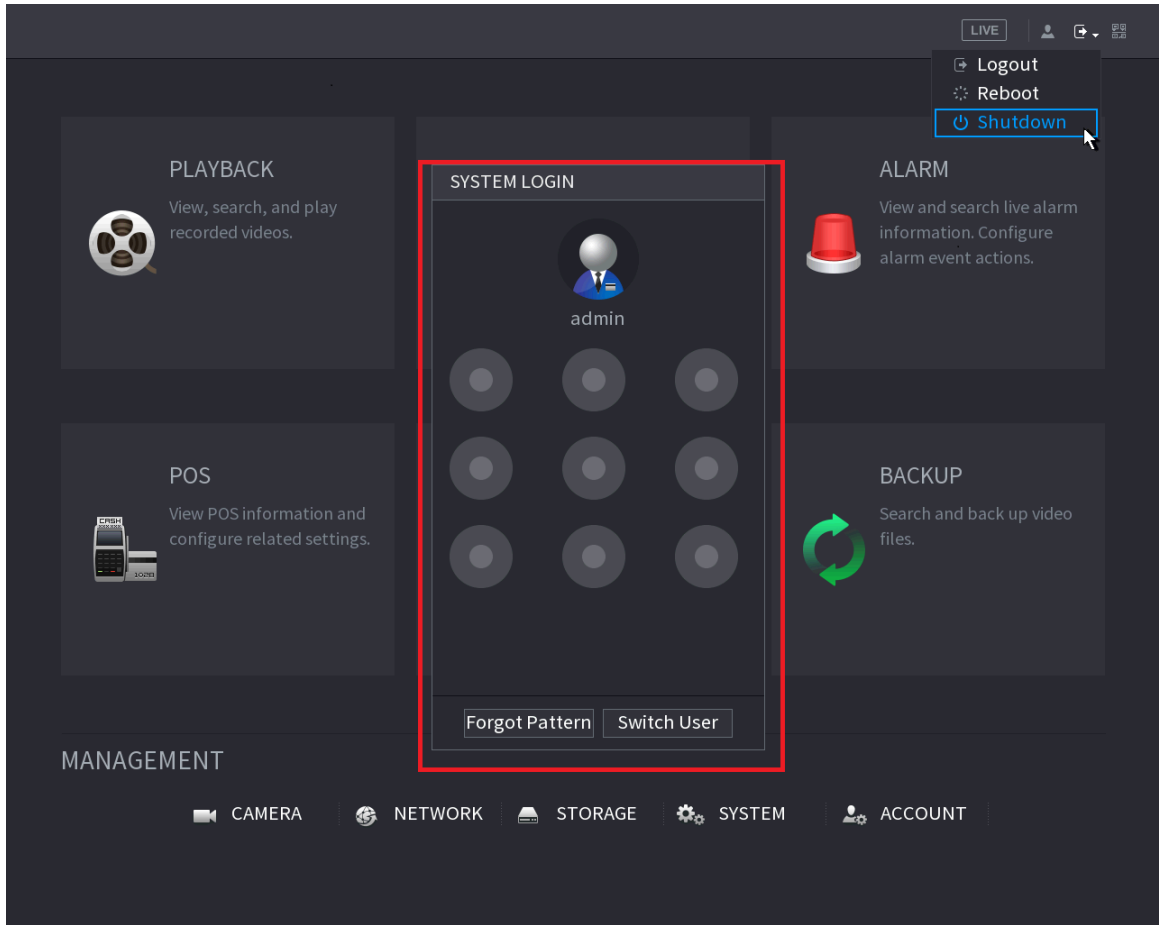
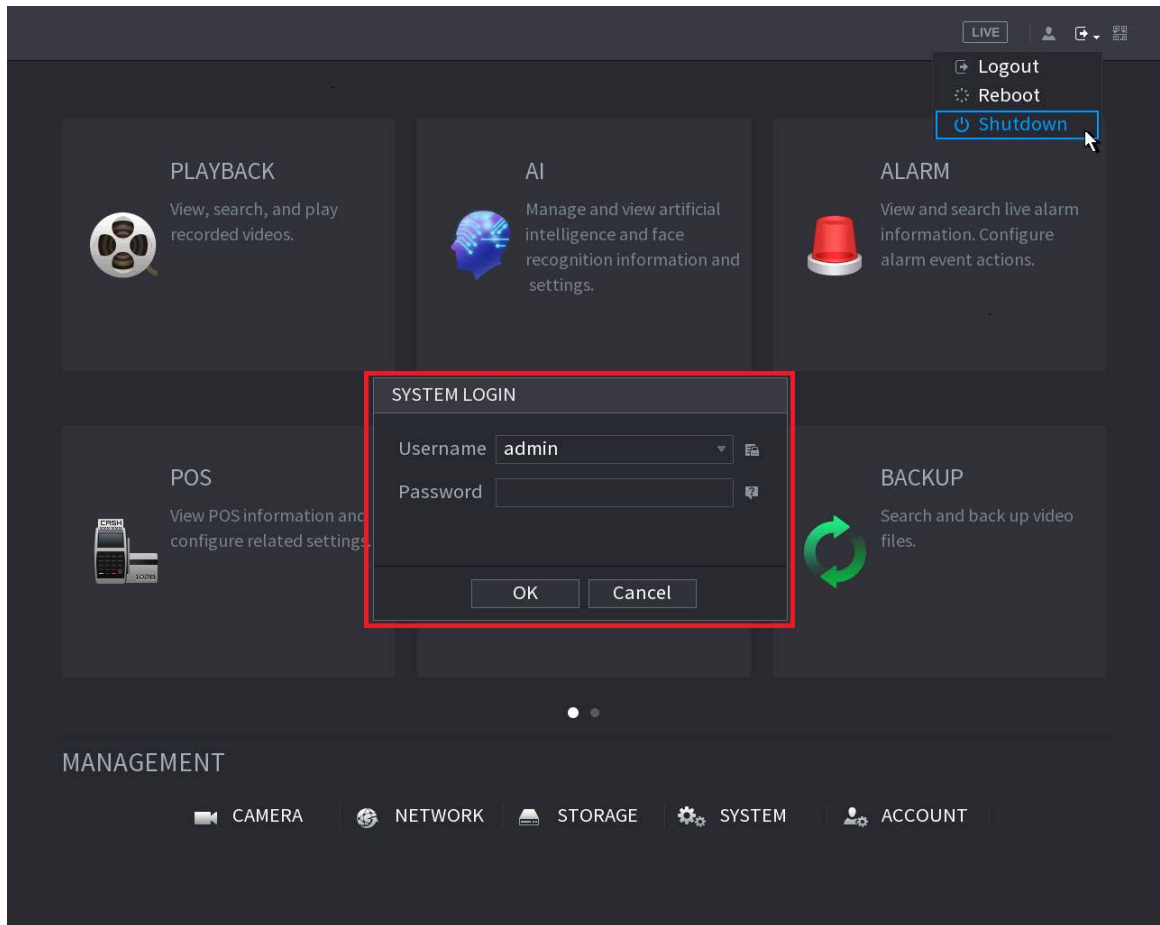

Figure 5-291 Shutdown (3)



- Remote Control
Press the power button on the remote for at least 3 seconds.
- Press the power button at the rear panel of the device.

Auto Resume after Power Failure

The system can automatically backup video file and resume previous working status after power failure.

6 Web Operation



- The figures in the Manual are used for introducing the operations and only for reference. The actual interface might be different dependent on the model you purchased.
- The Manual is a general document for introducing the product, so there might be some functions described for the Device in the Manual not apply to the model you purchased.
- Besides Web, you can use our Smart PSS to login the device. For detailed information, see Smart PSS user's manual.

6.1 Network Connection

Background Information



- The factory default IP of the Device is 192.168.1.108.
- The Device supports monitoring on different browsers such as Safari, Firefox, Google to perform the functions such as multi-channel monitoring, PTZ control, and device parameters configurations.

Procedure

- Step 1 Check to make sure the Device has connected to the network.
- Step 2 Configure the IP address, subnet mask and gateway for the PC and the Device. For details about network configuration of the Device, see "5.19.3 Network".
- Step 3 On your PC, check the network connection of the Device by using "ping ***.***.***.***". Usually the return value of TTL is 255.

6.2 Web Login

Procedure

- Step 1 Open the browser, enter the IP address of the Device, and then press Enter.

Figure 6-1 Login

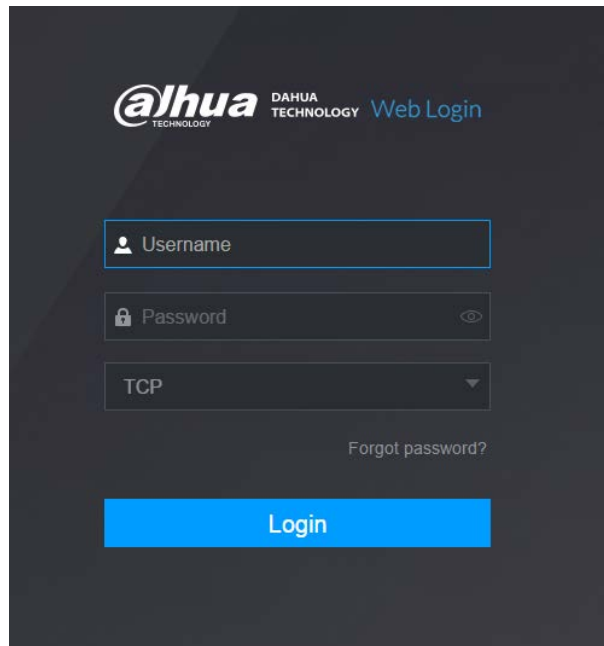

Step 2 Enter the username and password.



- The default administrator account is **admin**. The password is the one that was configured during initial settings. To ensure your account security, we recommend you keep the password properly and change it regularly.
- Click  to display the password.

Step 3 Click **Login**.

6.3 Web Main Menu

After you have logged in to the web, the main menu is displayed.
For detailed operations, see "5 Local Operations".

Figure 6-2 Main menu



Table 6-1 Main menu symbols

No.	Icon	Description
1		Includes configuration menu through which you can configure camera settings, network settings, storage settings, system settings, account settings, and view information.
2	None	Displays system date and time.
3		When you point to , the current user account is displayed.
4		Click , select Logout, Reboot, or Shutdown according to your actual situation.
5		Displays Cell Phone Client and Device SN QR Code. <ul style="list-style-type: none"> Cell Phone Client: Use your mobile phone to scan the QR code to add the device into the Cell Phone Client, and then you can start accessing the Device from your cell phone. Device SN: Obtain the Device SN by scanning the QR code. Go to the P2P management platform and add the Device SN into the platform. Then you can access and manage the device in the WAN. For details, see the P2P operation manual. You can also configure P2P function in the local configurations, see "5.11.18 P2P".
6		Displays the web main menu.

No.	Icon	Description
7	None	<p>Includes eight function tiles: LIVE, PLAYBACK, AI, ALARM, POS, OPERATION, BACKUP, DISPLAY, and AUDIO. Click each tile to open the configuration interface of the tile.</p> <ul style="list-style-type: none"> ● LIVE: You can perform the operations such as viewing real-time video, configuring channel layout, setting PTZ controls, and using smart talk and instant record functions if needed. ● PLAYBACK: Search for and play back the recorded video saved on the Device. ● ALARM: Search for alarm information and configure alarm event actions. ● AI: Configure and manage artificial intelligent events. It includes smart search, parameters, and database. ● POS: View POS information and configure related settings. ● OPERATION: View system information, import/export system configuration files, or update system. ● BACKUP: Search and back up the video files to the local PC or external storage device such as USB storage device. ● DISPLAY: Configure the display effect such as displaying content, image transparency, and resolution, and enable the zero-channel function. ● AUDIO: Manage audio files and configure the playing schedule. The audio file can be played in response to an alarm event if the voice prompts function is enabled.

6.4 Cluster Service

The cluster function, also known as cluster redundancy, is a kind of deployment method that can improve the reliability of the device. In the cluster system, there is a number of main devices and another number of sub devices (the N+M mode), and they have a virtual IP address (the cluster IP). When the main device fails, the corresponding sub device will take over the job automatically. When the main device recovers, the sub device will transmit the configuration data, cluster IP address and videos recorded during the failure to the main device which then takes over the job again.

In the N+M cluster system, there is a management server, the DCS (Dispatching Console) server, which is responsible for timely and correct scheduling management of the main and sub devices. When you create a cluster, the current device is used as the first sub device and the DCS server by default.



This function is available on select models.

6.4.1 Configuring Cluster IP

Background Information

When the main device malfunctions, the sub device can use the main device configuration and virtual IP address to replace the work (monitor or record) accordingly. When you use the virtual IP to access the device, you can still view the real-time video and there is no risk of record loss.

Procedure

- Step 1 Log in to the web as the admin user.
- Step 2 Select **SETTING > Cluster Service > CLUSTER IP**.
- Step 3 Select **Enable**.
- Step 4 Configure **IP Address, Subnet Mask** and **Default Gateway**.
- Step 5 Click **OK**.

6.4.2 Main Device

Background Information

You can add several main devices manually. After you enable the cluster function, you can view IP address, working status and connection log of the main device.

Procedure

- Step 1 Select **SETTING > Cluster Service > Main Device**.
- Step 2 Click **Manual Add**.

Figure 6-3 Manual add

Step 3 Configure parameters.

Table 6-2 Parameters of adding main device

Parameter	Description
Device Name	Customize the device name.
IP Address	Enter the IP address of the NVR.
Port	Set the TCP port number of the server. The default value is 37777.  You can view the current TCP port number in SETTING > Network > Port .
Username/Password	Enter the username and password of the NVR.

Step 4 Click **OK**.

Step 5 (Optional) Click  to view event occurrence time, name, operation and reason.

6.4.3 Sub Device

Background Information

When you add the first sub device, the default IP is the device IP address that logs in on the web. From **SETTING > Cluster Service > Sub Device**, you can add sub devices. For details, see "6.4.2 Main Device".



When adding the first sub device, you need not enter the IP address, because the first sub device is the current device by default.

After you added main device and sub device, you need to enable cluster function. See "6.4.5

Configuring Cluster Control" for more information.

6.4.4 Transferring Videos

After the main device has recovered, the videos recorded on the sub device during the failure period can be transferred to the main device.

Prerequisites

The main device works normally.

Procedure

Step 1 Select **SETTING** > **Cluster Service** > **Transfer Recorder**.

Step 2 Click **Add Task**.

Step 3 Configure parameters.

Step 4 Click **OK**.

You can click  to view details on the transferring task.

6.4.5 Configuring Cluster Control

6.4.5.1 Cluster Control

Background Information

From **SETTING** > **Cluster Service** > **Cluster Control**, you can enable or disable cluster.

Figure 6-4 Start cluster

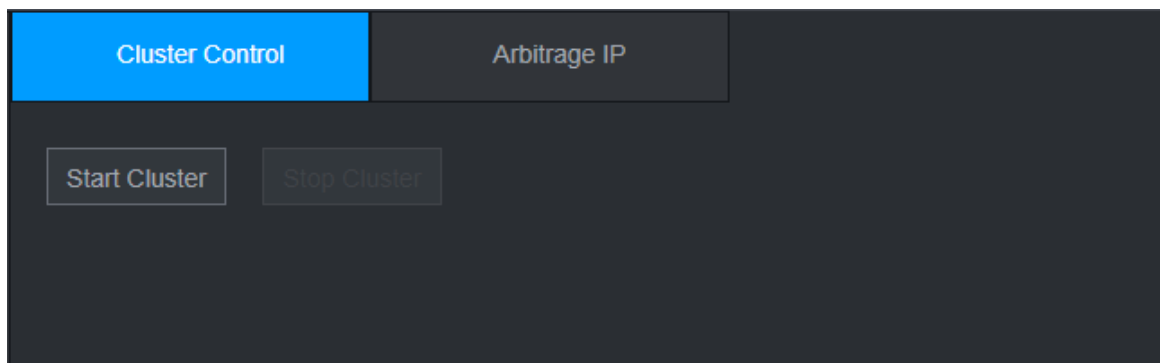

You can see the corresponding prompt if you successfully enabled cluster service.

6.4.5.2 Arbitrage IP

Background Information

When there are only 2 devices in the cluster, a third-party device is required to determine whether the main device is faulty, so arbitration IP must be set for the cluster to perform a normal replacement operation. The arbitration IP can be the IP address of another device, computer or gateway.

Procedure

Step 1 Select **SETTING > Cluster Service > Arbitrage IP**.

Figure 6-5 Arbitrage IP

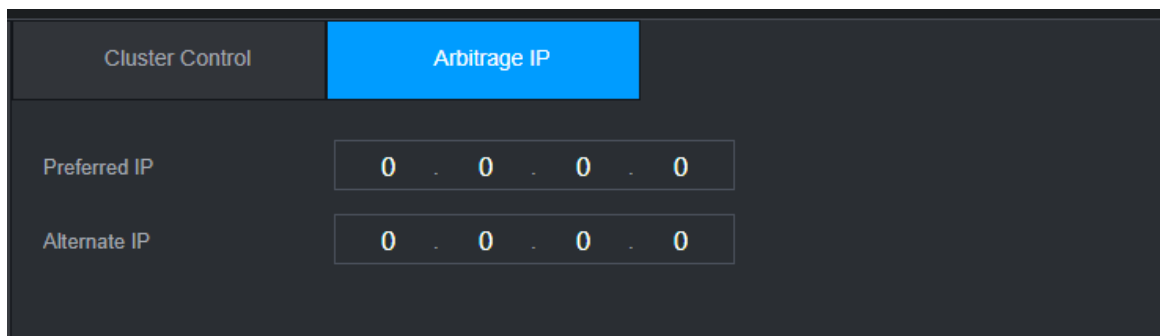

Step 2 Configure the preferred and alternate IP.

Step 3 Click **OK**.

6.4.6 Cluster Log

Background Information

You can search for and view cluster logs.

Procedure

Step 1 Select **SETTING > Cluster Service > Cluster Log**.

Figure 6-6 Cluster log

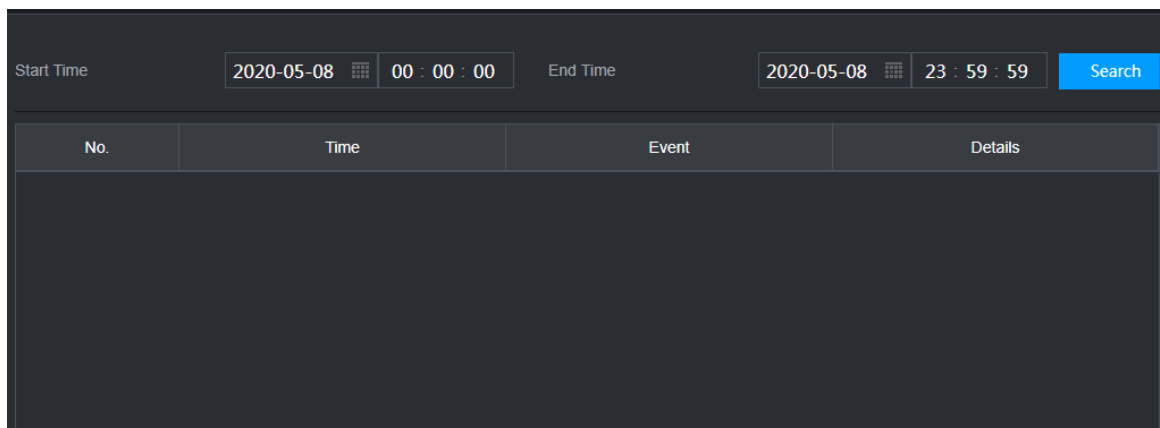

Step 2 Enter the start time and end time.

Step 3 Click **Search**.

7 Glossary

- **DHCP:** DHCP (Dynamic Host Configuration Protocol) is one of the TCP/IP protocol cluster. It is mainly used to assign temporary IP addresses to computers on a network.
- **DDNS:** DDNS (Dynamic Domain Name Server) is a service that maps Internet domain names to IP addresses. This service is useful to anyone who wants to operate a server (web server, mail server, ftp server and more.) connected to the internet with a dynamic IP or to someone who wants to connect to an office computer or server from a remote location with software.
- **eSATA:** eSATA (External Serial AT) is an interface that provides fast data transfer for external storage devices. It is the extension specifications of a SATA interface.
- **GPS:** GPS (Global Positioning System) is a satellite system, protected by the US, safely orbiting thousands of kilometers above the earth.
- **PPPoE:** PPPoE (Point to Point Protocol over Ethernet) is a specification for connecting multiple computer users on an Ethernet local area network to a remote site. Now the popular mode is ADSL and it adopts PPPoE protocol.
- **Wi-Fi:** Wi-Fi is the name of a popular wireless networking technology that uses radio waves to provide wireless high-speed Internet and network connections. The standard is for wireless local area networks (WLANs). It is like a common language that all the devices use to communicate to each other. It is actually IEEE802.11, a family of standard The IEEE (Institute of Electrical and Electronics Engineers Inc.)
- **3G:** 3G is the wireless network standard. It is called 3G because it is the third generation of cellular telecom standards. 3G is a faster network for phone and data transmission and speed is over several hundred kbps. Now there are four standards: CDMA2000, WCDMA, TD-SCDMA and WiMAX.
- **Dual-stream:** The dual-stream technology adopts high-rate bit stream for local HD storage such as QCIF/CIF/2CIF/DCIF/4CIF encode and one low-rate bit stream for network transmission such as QCIF/CIF encode. It can balance the local storage and remote network transmission. The dual-stream can meet the difference band width requirements of the local transmission and the remote transmission. In this way, the local transmission using high-bit stream can achieve HD storage and the network transmission adopting low bit stream suitable for the fluency requirements of the 3G network such as WCDMA, EVDO, TD-SCDMA.
- **On-off value:** It is the non-consecutive signal sampling and output. It includes remote sampling and remote output. It has two statuses: 1/0.

8 FAQ

Questions	Reasons
The Device failed to start properly.	<ul style="list-style-type: none"> ● Incorrect input power. ● Incorrect connection of the power cord. ● Damaged power switch. ● Wrong program. ● Damaged HDD. ● Damaged mainboard.
The Device automatically shuts down or stops running.	<ul style="list-style-type: none"> ● Unstable or insufficient input voltage. ● Insufficient button power. ● Improper operating environment. ● Hardware error.
The Device cannot detect HDD.	<ul style="list-style-type: none"> ● Damaged HDD or HDD ribbon. ● Loose connection of HDD cable. ● Damaged SATA port.
There is no video output in all channels.	<ul style="list-style-type: none"> ● Program version is not correct. ● Brightness is 0. ● Hardware error.
I cannot find local records.	<ul style="list-style-type: none"> ● Damaged HDD or HDD ribbon. ● Program version is not correct. ● The recorded file has been overwritten. ● The recording function has been disabled.
Distorted recorded videos.	<ul style="list-style-type: none"> ● Video quality setup is too low. ● Program read error, bit data is too small. There is mosaic in the full screen. Restart the NVR to solve this problem. ● HDD data ribbon error. ● HDD malfunction. ● NVR hardware malfunctions.
Time display is not correct.	<ul style="list-style-type: none"> ● Setup is not correct. ● Battery contact is not correct or voltage is too low. ● Crystal is broken.

Questions	Reasons
NVR cannot control PTZ.	<ul style="list-style-type: none"> ● Front panel PTZ error. ● PTZ decoder setup, connection or installation is not correct. ● Cable connection is not correct. ● PTZ setup is not correct. ● PTZ decoder and NVR protocol is not compatible. ● PTZ decoder and NVR address is not compatible. ● When there are several decoders, add 120 Ohm between the PTZ decoder A/B cables furthest end to delete the reverberation or impedance matching. Otherwise the PTZ control is not stable. ● The distance is too far.
I cannot log in client-end or web.	<ul style="list-style-type: none"> ● For Windows 98 or Windows ME user, update your system to Windows 2000 sp4. Or you can install client-end software of lower version. Please note right now, our NVR is not compatible with Windows VISTA control. ● ActiveX control has been disabled. ● No dx8.1 or higher. Upgrade display card driver. ● Network connection error. ● Network setup error. ● Password or username is invalid. ● Client-end is not compatible with NVR program.
There is only mosaic no video when preview or playback video file remotely.	<ul style="list-style-type: none"> ● Network fluency is not good. ● Client-end resources are limit. ● Current user has no right to monitor.
Network connection is not stable.	<ul style="list-style-type: none"> ● Network is not stable. ● IP address conflict. ● MAC address conflict. ● PC or device network card is not good.
Burn error /USB back error.	<ul style="list-style-type: none"> ● Burner and NVR are in the same data cable. ● System uses too much CPU resources. Stop record first and then begin backup. ● Data amount exceeds backup device capacity. It might result in burner error. ● Backup device is not compatible. ● Backup device is damaged.
Keyboard cannot control NVR.	<ul style="list-style-type: none"> ● NVR serial port setup is not correct. ● Address is not correct. ● When there are several switchers, power supply is not enough. ● Transmission distance is too far.

Questions	Reasons
Alarm signal cannot be disarmed.	<ul style="list-style-type: none"> ● Alarm setup is not correct. ● Alarm output has been open manually. ● Input device error or connection is not correct. ● Some program versions might have this problem. Upgrade your system.
Alarm function is null.	<ul style="list-style-type: none"> ● Alarm setup is not correct. ● Alarm cable connection is not correct. ● Alarm input signal is not correct. ● There are two loops connect to one alarm device.
Record storage period is not enough.	<ul style="list-style-type: none"> ● Camera quality is too low. Lens is dirty. Camera is installed against the light. Camera aperture setup is not correct. ● HDD capacity is not enough. ● HDD is damaged.
Cannot playback the downloaded file.	<ul style="list-style-type: none"> ● There is no media player. ● No DXB8.1 or higher graphic acceleration software. ● There is no DivX503Bundle.exe control when you play the file transformed to AVI via media player. ● No DivX503Bundle.exe or ffdshow-2004 1012 .exe in Windows XP OS.
Forgot local menu operation password or network password	Contact your local service engineer or our sales person for help. We can guide you to solve this problem.
There is no video. The screen is in black.	<ul style="list-style-type: none"> ● IPC IP address is not right. ● IPC port number is not right. ● IPC account (username/password) is not right. ● IPC is offline.
The displayed video is not full in the monitor.	Check current resolution setup. If the current setup is 1920*1080, then you need to set the monitor resolution as 1920*1080.
There is no HDMI output.	<ul style="list-style-type: none"> ● Displayer is not in HDMI mode. ● HDMI cable connection is not right.
The video is not fluent when I view in multiple-channel mode from the client-end.	<ul style="list-style-type: none"> ● The network bandwidth is not sufficient. The multiple-channel monitor operation needs at least 100M or higher. ● Your PC resources are not sufficient. For 16-ch remote monitor operation, the PC shall have the following environment: Quad Core, 2G or higher memory, independent displayer, display card memory 256M or higher.

Questions	Reasons
I cannot connect to the IPC	<ul style="list-style-type: none"> ● Make sure that the IPC has booted up. ● IPC network connection is right and it is online ● IPC IP is in the blacklist. ● The device has connected to the too many IPC. It cannot transmit the video. ● Check the IPC port value and the time zone is the same as the NVR. ● Make sure current network environment is stable.
After I set the NVR resolution as 1080P, my monitor cannot display.	Shut down the device and then reboot. When you reboot, press the Fn button at the same time and then release after 5 seconds. You can restore NVR resolution to the default setup.
My admin account has been changed and I cannot log in.	Use telnet and then input the following command: <pre>cd /mnt/mtd/Config/ rm -rf group rm -rf password</pre> Reboot the device to restore the default password.
After I login the Web, I cannot find the remote interface to add the IPC.	Clear the Web controls and load again.
There is IP and gateway, I can access the internet via the router. But I cannot access the internet after I reboot the NVR.	Use command PING to check you can connect to the gateway or not. Use telnet to access and then use command "ifconfig-a" to check device IP address. If you see the subnet mask and the gateway has changed after the reboot. Upgrade the applications and set again.
I use the VGA monitor. I want to know if I use the multiple-window mode, I see the video from the main stream or the sub stream?	<ul style="list-style-type: none"> ● For 32-channel series product, the 9/16-window is using the sub stream. ● For 4/8/16 series product, system is using the main stream no matter you are in what display mode.

Daily Maintenance

- Use the brush to clean the board, socket connector and the chassis regularly.
- The device shall be soundly earthed in case there is audio/video disturbance. Keep the device away from the static voltage or induced voltage.
- Unplug the power cable before you remove the audio/video signal cable, RS-232 or RS-485 cable.
- Do not connect the TV to the local video output port (VOUT). It might result in video output circuit.
- Always shut down the device properly. Use the shutdown function in the menu, or you can press the power button in the rear pane for at least three seconds to shut down the device. Otherwise it might result in HDD malfunction.
- Make sure the device is away from the direct sunlight or other heating sources. Keep the sound ventilation.
- Check and maintain the device regularly.

Appendix 1 HDD Capacity Calculation

Calculate the total capacity needed by each device according to video recording (video recording type and video file storage time).

1. According to Formula (1) to calculate storage capacity q_i that is the capacity of each channel needed for each hour, unit Mbyte.

$$q_i = d_i \div 8 \times 3600 \div 1024 \quad (1)$$

In the formula: d_i means the bit rate, unit Kbit/s

2. After video time requirement is confirmed, according to Formula (2) to calculate the storage capacity m_i , which is storage of each channel needed unit Mbyte.

$$m_i = q_i \times h_i \times D_i \quad (2)$$

In the formula:

h_i means the recording time for each day (hour)

D_i means number of days for which the video shall be kept

3. According to Formula (3) to calculate total capacity (accumulation) q_T that is needed for all channels in the device during **scheduled video recording**

$$q_T = \sum_{i=1}^c m_i \quad (3)$$

In the formula:

c means total number of channels in one device

4. According to Formula (4) to calculate total capacity (accumulation) q_T that is needed for all channels in device during **alarm video recording (including motion detection)**

$$q_T = \sum_{i=1}^c m_i \times a\% \quad (4)$$

In the formula: $a\%$ means alarm occurrence rate

Appendix 2 Mouse Operation

Appendix Table 2-1 Mouse operation

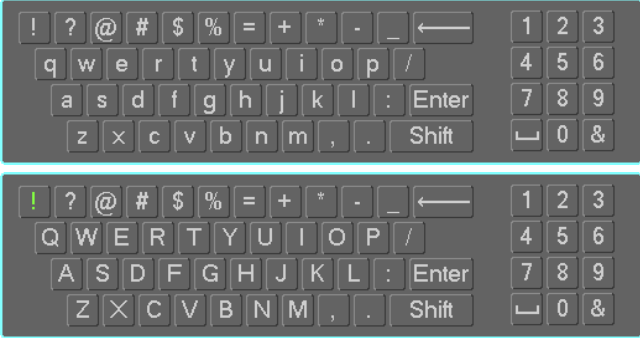
Operation	Description
Left click mouse	When you have selected one menu item, left click mouse to view menu content.
	Modify checkbox or motion detection status.
	Click combo box to pop up drop-down list
	In input box, you can select input methods. Left click the corresponding button on the panel you can input numeral/English character (lower case/upper case). Here← stands for backspace button. _ stands for space button. In English input mode: _ stands for input a backspace icon and← stands for deleting the previous character.
	
	In numeral input mode: _ stands for clear and← stands for deleting the previous numeral.
Double left click mouse	Implement special control operation such as double click one item in the file list to playback the video.
	In multiple-window mode, double left click one channel to view in full-window.
	Double left click current video again to go back to previous multiple-window mode.
Right click mouse	In real-time monitor mode, pops up shortcut menu.
	Exit current menu without saving the modification.
Press middle button	In numeral input box: Increase or decrease numeral value.
	Switch the items in the checkbox.
	Page up or page down.
Move mouse	Select current control or move control.
Drag mouse	Select motion detection zone.
	Select privacy mask zone.

Appendix 3 Remote Control



Remote control is not our standard accessory and it is not included in the accessory package.

Appendix Figure 3-1 Remote control

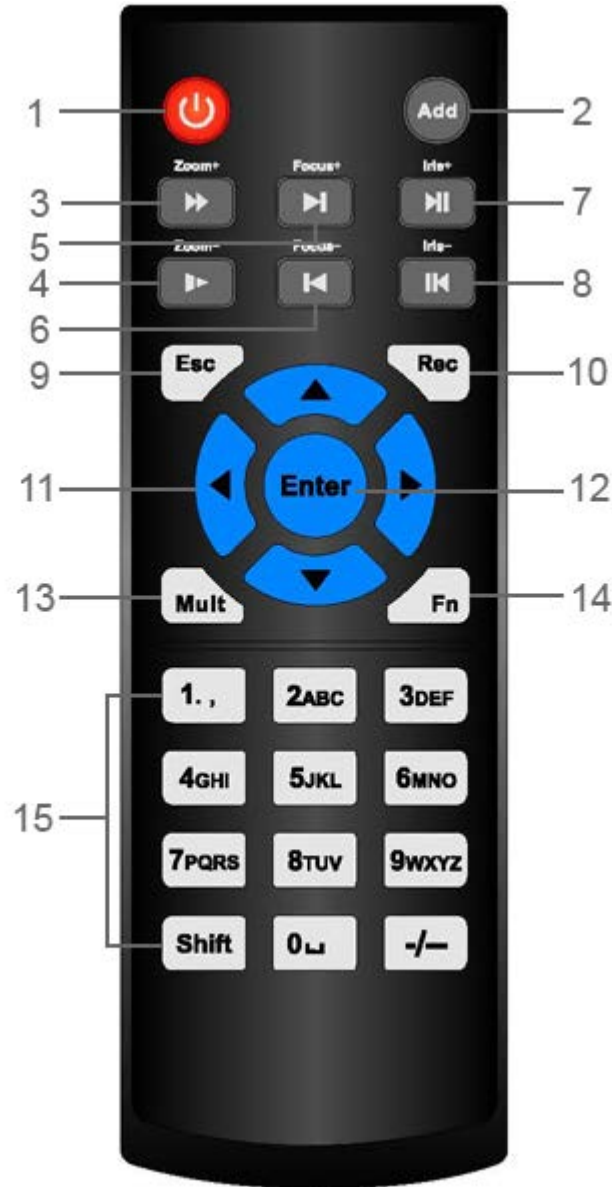

No.	Name	Function
1	Power button	Press this button to boot up or shut down the device.
2	Address	Press this button to input device serial number, so that you can control the Device.
3	Forward	Multi-step forward speed and normal speed playback.
4	Slow motion	Multi-step slow motion speed or normal playback.
5	Next record	In playback state, press this button to play back the next video.

No.	Name	Function
6	Previous record	In playback state, press this button to play back the previous video.
7	Play/Pause	<ul style="list-style-type: none"> • In normal playback state, press this button to pause playback. • In pause state, press this button to resume to normal playback. • In live view window interface, press this button to enter video search menu.
8	Reverse/pause	In the reverse playback state, press this button to pause reverse playback.
		In the reverse playback pause state, press this button to resume to playback reversing state.
9	Esc	Go back to previous menu or cancel current operation (close front interface or control).
10	Record	<ul style="list-style-type: none"> • Start or stop record manually. • In record interface, use the direction buttons to select the channel that you want to record. • Press this button for at least 1.5 seconds, and the manual record interface will be displayed.
11	Direction keys	Switch between current activated controls by going left or right. In playback state, the keys control the playback progress bar. Aux function (such as operating the PTZ menu).
12	Enter/menu key	<ul style="list-style-type: none"> • Confirms an operation. • Go to the OK button. • Go to the menu.
13	Multiple-window switch	Switch between multiple-window and one-window.
14	Fn	<ul style="list-style-type: none"> • In single-channel monitoring mode, press this button to display the PTZ control and color setting functions. • Switch the PTZ control menu in PTZ control interface. • In motion detection interface, press this button with direction keys to complete setup. • In text mode, press and hold this button to delete the last character. To use the clearing function: Long press this button for 1.5 seconds. • In HDD menu, switch HDD recording time and other information as indicated in the pop-up message.

No.	Name	Function
15	Alphanumeric keys	<ul style="list-style-type: none">• Input password, numbers.• Switch channel.• Press Shift to switch the input method.

Appendix 4 Compatible Network Camera List

Please note all the models in the following list for reference only. For those products not included in the list, please contact your local retailer or technical supporting engineer for detailed information.

Appendix Table 4-1 Compatible network camera list

Manufacturer	Model	Version	Video Encode	Audio/Video	Protocol
AXIS	P1346	5.40.9.2	H264	√	ONVIF/Private
	P3344/P3344-E	5.40.9.2	H264	√	ONVIF/Private
	P5512	—	H264	√	ONVIF/Private
	Q1604	5.40.3.2	H264	√	ONVIF/Private
	Q1604-E	5.40.9	H264	√	ONVIF/Private
	Q6034E	—	H264	√	ONVIF/Private
	Q6035	5.40.9	H264	√	ONVIF/Private
	Q1755	—	H264	√	ONVIF/Private
	M7001	—	H264	√	Private
	M3204	5.40.9.2	H264	√	Private
	P3367	HEAD LFP4_0130220	H264	√	ONVIF
	P5532-P	HEAD LFP4_0130220	H264	√	ONVIF
ACTi	ACM-3511	A1D-220-V3.12.15-AC	MPEG4	√	Private
	ACM-8221	A1D-220-V3.13.16-AC	MPEG4	√	Private
Arecont	AV1115	65246	H264	√	Private
	AV10005DN	65197	H264	√	Private
	AV2115DN	65246	H264	√	Private
	AV2515DN	65199	H264	√	Private
	AV2815	65197	H264	√	Private
	AV5115DN	65246	H264	√	Private
	AV8185DN	65197	H264	√	Private
Bosch	NBN-921-P	—	H264	√	ONVIF
	NBC-455-12P	—	H264	√	ONVIF
	VG5-825	9500453	H264	√	ONVIF

Manufacturer	Model	Version	Video Encode	Audio/Video	Protocol
	NBN-832	66500500	H264	√	ONVIF
	VEZ-211-IW TEIVA	—	H264	√	ONVIF
	NBC-255-P	15500152	H264	√	ONVIF
	VIP-X1XF	—	H264	√	ONVIF
Brikcom	B0100	—	H264	√	ONVIF
	D100	—	H264	√	ONVIF
	GE-100-CB	—	H264	√	ONVIF
	FB-100A	v1.0.3.9	H264	√	ONVIF
	FD-100A	v1.0.3.3	H264	√	ONVIF
Cannon	VB-M400	—	H264	√	Private
CNB	MPix2.0DIR	XNETM11201 11229	H264	√	ONVIF
	VIPBL1.3MI RVF	XNETM21001 11229	H264	√	ONVIF
	IGC-2050F	XNETM21001 11229	H264	√	ONVIF
CP PLUS	CP-NC9-K	6.E.2.7776	H264	√	ONVIF/Private
	CP-NC9W-K	6.E.2.7776	H264	√	Private
	CP-ND10-R	cp20111129 ANS	H264	√	ONVIF
	CP-ND20-R	cp20111129 ANS	H264	√	ONVIF
	CP-NS12W- CR	cp20110808 NS	H264	√	ONVIF
	VS201	cp20111129 NS	H264	√	ONVIF
	CP-NB20-R	cp20110808B NS	H264	√	ONVIF
	CP-NT20VL 3-R	cp20110808B NS	H264	√	ONVIF
	CP-NS36W- AR	cp20110808 NS	H264	√	ONVIF
	CP-ND20VL 2-R	cp20110808B NS	H264	√	ONVIF
	CP-RNP-18 20	cp20120821 NSA	H264	√	Private
	CP-RNC-TP 20FL3C	cp20120821 NSA	H264	√	Private

Manufacturer	Model	Version	Video Encode	Audio/Video	Protocol
	CP-RNP-12D	cp20120828ANS	H264	√	Private
	CP-RNC-DV10	cp20120821NSA	H264	√	Private
	CP-RNC-DP20FL2C	cp20120821NSA	H264	√	Private
Dynacolor	ICS-13	d20120214NS	H264	√	ONVIF/Private
	ICS-20W	vt20111123NSA	H264	√	ONVIF/Private
	NA222	—	H264	√	ONVIF
	MPC-IPVD-0313	k20111208ANS	H264	√	ONVIF/Private
	MPC-IPVD-0313AF	k20111208BNS	H264	√	ONVIF/Private
Honeywell	HIDC-1100PT	h.2.2.1824	H264	√	ONVIF
	HIDC-1100P	h.2.2.1824	H264	√	ONVIF
	HIDC-0100P	h.2.2.1824	H264	√	ONVIF
	HIDC-1300V	2.0.0.21	H264	√	ONVIF
	HICC-1300W	2.0.1.7	H264	√	ONVIF
	HICC-2300	2.0.0.21	H264	√	ONVIF
	HDZ20HDX	H20130114NSA	H264	√	ONVIF
LG	LW342-FP	—	H264	√	Private
	LNBS100	—	H264	√	ONVIF
Imatek	KNC-B5000	—	H264	√	Private
	KNC-B5162	—	H264	√	Private
	KNC-B2161	—	H264	√	Private
Panasonic	NP240/CH	—	MPEG4	√	Private
	WV-NP502	—	MPEG4	√	Private
	WV-SP102H	1.41	H264	√	ONVIF/Private
	WV-SP105H	—	H264	√	ONVIF/Private

Manufacturer	Model	Version	Video Encode	Audio/Video	Protocol
	WV-SP302H	1.41	H264, MPEG4	√	ONVIF/Private
	WV-SP306H	1.4	H264, MPEG4	√	ONVIF/Private
	WV-SP508H	—	H264, MPEG4	√	ONVIF/Private
	WV-SP509H	—	H264, MPEG4	√	ONVIF/Private
	WV-SF332H	1.41	H264, MPEG4	√	ONVIF/Private
	WV-SW316H	1.41	H264, MPEG4	√	ONVIF/Private
	WV-SW355H	1.41	H264, MPEG4	√	ONVIF/Private
	WV-SW352H	—	H264, MPEG4	√	ONVIF/Private
	WV-SW152E	1.03	H264, MPEG4	√	ONVIF/Private
	WV-SW558H	—	H264, MPEG4	√	ONVIF/Private
	WV-SW559H	—	H264, MPEG4	√	ONVIF/Private
	WV-SP105H	1.03	H264, MPEG4	√	ONVIF/Private
	WV-SW155E	1.03	H264, MPEG4	√	ONVIF/Private
	WV-SF336H	1.44	H264, MPEG4	√	ONVIF/Private
	WV-SF332H	1.41	H264, MPEG4	√	ONVIF/Private
	WV-SF132E	1.03	H264, MPEG4	√	ONVIF/Private
	WV-SF135E	1.03	H264, MPEG4	√	ONVIF/Private
	WV-SF346H	1.41	H264, MPEG4	√	ONVIF/Private
	WV-SF342H	1.41	H264, MPEG4	√	ONVIF/Private
	WV-SC385H	1.08	H264, MPEG4	√	ONVIF/Private
	WV-SC386H	1.08	H264, MPEG4	√	ONVIF/Private

Manufacturer	Model	Version	Video Encode	Audio/Video	Protocol
	WV-SP539	1.66	H264, MPEG4	√	ONVIF
	DG-SC385	1.66	H264, MPEG4	√	ONVIF
PELCO	IXSOLW	1.8.1-201109 12-1.9082-A1 .6617	H264	√	Private
	IDE20DN	1.7.41.9111- O3.6725	H264	√	Private
	D5118	1.7.8.9310-A1 .5288	H264	√	Private
	IM10C10	1.6.13.9261- O2.4657	H264	√	Private
	DD4N-X	01.02.0015	MPEG4	√	Private
	DD423-X	01.02.0006	MPEG4	√	Private
	D5220	1.8.3-FC2-201 20614-1.9320 -A1.8035	H264	√	Private
Samsung	SNB-3000P	2.41	H264, MPEG4	√	ONVIF/Private
	SNP-3120	1.22_110120 _1	H264, MPEG4	√	ONVIF/Private
	SNP-3370	1.21_110318	MPEG4	√	Private
	SNB-5000	2.10_111227	H264, MPEG4	√	ONVIF/Private
	SND-5080	—	H264, MPEG4	√	Private
	SNZ-5200	1.02_110512	H264, MPEG4	√	ONVIF/Private
	SNP-5200	1.04_110825	H264, MPEG4	√	ONVIF/Private
	SNB-7000	1.10_110819	H264	√	ONVIF/Private
	SNB-6004	V1.0.0	H264	√	ONVIF
Sony	SNC-D H110	1.50.00	H264	√	ONVIF/Private
	SNC-CH120	1.50.00	H264	√	ONVIF/Private
	SNC-CH135	1.73.01	H264	√	ONVIF/Private
	SNC-CH140	1.50.00	H264	√	ONVIF/Private
	SNC-CH210	1.73.00	H264	√	ONVIF/Private
	SNC-D H210	1.73.00	H264	√	ONVIF/Private

Manufacturer	Model	Version	Video Encode	Audio/Video	Protocol
	SNC-D H240	1.50.00	H264	√	ONVIF/Private
	SNC-D H240-T	1.73.01	H264	√	ONVIF/Private
	SNC-CH260	1.74.01	H264	√	ONVIF/Private
	SNC-CH280	1.73.01	H264	√	ONVIF/Private
	SNC-RH-124	1.73.00	H264	√	ONVIF/Private
	SNC-RS46P	1.73.00	H264	√	ONVIF/Private
	SNC-ER550	1.74.01	H264	√	ONVIF/Private
	SNC-ER580	1.74.01	H264	√	ONVIF/Private
	SNC-ER580	1.78.00	H264	√	ONVIF
	SNC-VM631	1.4.0	H264	√	ONVIF
	WV-SP306	1.61.00	H264, MPEG4	√	SDK
	WV-SP306	1.61.00	H264	√	ONVIF
	SNC-VB600	1.5.0	H264	√	Private
	SNC-VM600	1.5.0	H264	√	Private
	SNC-VB630	1.5.0	H264	√	Private
	SNC-VM630	1.5.0	H264	√	Private
SANYO	VCC-HDN4000PC	—	H264	√	ONVIF

Appendix 5 Cybersecurity Recommendations

Cybersecurity is more than just a buzzword: it's something that pertains to every device that is connected to the internet. IP video surveillance is not immune to cyber risks, but taking basic steps toward protecting and strengthening networks and networked appliances will make them less susceptible to attacks. Below are some tips and recommendations from Dahua on how to create a more secured security system.

Mandatory actions to be taken for basic device network security:

1. Use Strong Passwords

Please refer to the following suggestions to set passwords:

- The length should not be less than 8 characters.
- Include at least two types of characters; character types include upper and lower case letters, numbers and symbols.
- Do not contain the account name or the account name in reverse order.
- Do not use continuous characters, such as 123, abc, etc.
- Do not use overlapped characters, such as 111, aaa, etc.

2. Update Firmware and Client Software in Time

- According to the standard procedure in Tech-industry, we recommend to keep your device (such as NVR, DVR, IP camera, etc.) firmware up-to-date to ensure the system is equipped with the latest security patches and fixes. When the device is connected to the public network, it is recommended to enable the "auto-check for updates" function to obtain timely information of firmware updates released by the manufacturer.
- We suggest that you download and use the latest version of client software.

"Nice to have" recommendations to improve your device network security:

1. Physical Protection

We suggest that you perform physical protection to device, especially storage devices. For example, place the device in a special computer room and cabinet, and implement well-done access control permission and key management to prevent unauthorized personnel from carrying out physical contacts such as damaging hardware, unauthorized connection of removable device (such as USB flash disk, serial port), etc.

2. Change Passwords Regularly

We suggest that you change passwords regularly to reduce the risk of being guessed or cracked.

3. Set and Update Passwords Reset Information Timely

The device supports password reset function. Please set up related information for password reset in time, including the end user's mailbox and password protection questions. If the information changes, please modify it in time. When setting password protection questions, it is suggested not to use those that can be easily guessed.

4. Enable Account Lock

The account lock feature is enabled by default, and we recommend you to keep it on to guarantee the account security. If an attacker attempts to log in with the wrong password several times, the corresponding account and the source IP address will be locked.

5. Change Default HTTP and Other Service Ports

We suggest you to change default HTTP and other service ports into any set of numbers between

1024–65535, reducing the risk of outsiders being able to guess which ports you are using.

6. **Enable HTTPS**

We suggest you to enable HTTPS, so that you visit Web service through a secure communication channel.

7. **MAC Address Binding**

We recommend you to bind the IP and MAC address of the gateway to the device, thus reducing the risk of ARP spoofing.

8. **Assign Accounts and Privileges Reasonably**

According to business and management requirements, reasonably add users and assign a minimum set of permissions to them.

9. **Disable Unnecessary Services and Choose Secure Modes**

If not needed, it is recommended to turn off some services such as SNMP, SMTP, UPnP, etc., to reduce risks.

If necessary, it is highly recommended that you use safe modes, including but not limited to the following services:

- SNMP: Choose SNMP v3, and set up strong encryption passwords and authentication passwords.
- SMTP: Choose TLS to access mailbox server.
- FTP: Choose SFTP, and set up strong passwords.
- AP hotspot: Choose WPA2-PSK encryption mode, and set up strong passwords.

10. **Audio and Video Encrypted Transmission**

If your audio and video data contents are very important or sensitive, we recommend that you use encrypted transmission function, to reduce the risk of audio and video data being stolen during transmission.

Reminder: encrypted transmission will cause some loss in transmission efficiency.

11. **Secure Auditing**

- Check online users: we suggest that you check online users regularly to see if the device is logged in without authorization.
- Check device log: By viewing the logs, you can know the IP addresses that were used to log in to your devices and their key operations.

12. **Network Log**

Due to the limited storage capacity of the device, the stored log is limited. If you need to save the log for a long time, it is recommended that you enable the network log function to ensure that the critical logs are synchronized to the network log server for tracing.

13. **Construct a Safe Network Environment**

In order to better ensure the safety of device and reduce potential cyber risks, we recommend:

- Disable the port mapping function of the router to avoid direct access to the intranet devices from external network.
- The network should be partitioned and isolated according to the actual network needs. If there are no communication requirements between two sub networks, it is suggested to use VLAN, network GAP and other technologies to partition the network, so as to achieve the network isolation effect.
- Establish the 802.1x access authentication system to reduce the risk of unauthorized access to private networks.
- Enable IP/MAC address filtering function to limit the range of hosts allowed to access the

device.

More information

Please visit Dahua official website security emergency response center for security announcements and the latest security recommendations.

ENABLING A SAFER SOCIETY AND SMARTER LIVING

ZHEJIANG DAHUA VISION TECHNOLOGY CO., LTD.

Address: No.1199 Bin'an Road, Binjiang District, Hangzhou, P. R. China | Website: www.dahuasecurity.com | Postcode: 310053

Email: overseas@dahuatech.com | Fax: +86-571-87688815 | Tel: +86-571-87688883