



IVSS

User's Manual



Foreword

General

This manual introduces the installation, functions and operations of the intelligent video surveillance server (hereinafter referred to as "the Device" or "IVSS"). Read carefully before using the device, and keep the manual safe for future reference.

Models

Number of HDDs	Models
8	DHI-IVSS7008; DHI-IVSS7008-M; DHI-IVSS7108-M
12	DHI-IVSS7012; DHI-IVSS7012-M; DHI-IVSS7112-M
16	DHI-IVSS7016; DHI-IVSS7016D; DHI-IVSS7016DR; DHI-IVSS7116; DHI-IVSS7116DR; DHI-IVSS7016-M; DHI-IVSS7016DR-M
24	DHI-IVSS7024; DHI-IVSS7024D; DHI-IVSS7024DR; DHI-IVSS7124; DHI-IVSS7024DR; DHI-IVSS7024-M; DHI-IVSS7024DR-M





Refer to the interface of each model for function details.



- In the model name, R indicates that the model has redundant power.
- In the model name, D indicates that the model has an LCD screen.

Safety Instruction

The following signal words might appear in the manual.

Signal Words	Meaning
 WARNING	Indicates a high potential hazard which, if not avoided, will result in death or serious injury.
 WARNING	Indicates a medium or low potential hazard which, if not avoided, could result in slight or moderate injury.
 CAUTION	Indicates a potential risk which, if not avoided, could result in property damage, data loss, reductions in performance, or unpredictable results.
 TIPS	Provides methods to help you solve a problem or save time.
 NOTE	Provides additional information as a supplement to the text.

Revision History

Version	Revision Content	Release Time
V5.0.2	Updated IVS description.	May 2022
V5.0.1	<ul style="list-style-type: none"> • Added anti-corrosion descriptions. • Updated ANPR description. 	March 2022

Version	Revision Content	Release Time
V5.0.0	<ul style="list-style-type: none"> Added the talk function on the view window. Added the audio and light alarm. Deleted the strategy of shortcut RAID creation. 	October 2021
V4.0.0	<ul style="list-style-type: none"> Added 1:1 face recognition. Added one-click disarming. Added SSD health detection. Added related search of face images and human body images. Added entries frequency. 	June 2021
V3.3.0	<ul style="list-style-type: none"> Added HDD installation introduction to the 8-HDD series. Added IVSS-M series. 	December 2020
V3.2.0	<ul style="list-style-type: none"> Added passerby database. Added IVS model switch Added algorithm version in the device list. Added Re-extract Eigenvector Again. Optimized people-counting, call alarm and smoking alarm. 	November 2020
V3.0.4	<ul style="list-style-type: none"> Optimized storage and recording configuration. Added PTZ settings. Added call detection and smoking detection. 	July 2020
V3.0.3	Added IVSS7116, IVSS7116DR, IVSS7124 and IVSS7124DR.	April 2020
V3.0.1	Added crowd distribution, and data security notes.	December 2019
V3.0.0	<ul style="list-style-type: none"> Added search by image, cluster, and fisheye dewarp. Updated chapters including intelligent operation and device management according to the new device version. 	December 2019
V2.1.0	<ul style="list-style-type: none"> Added video metadata, vehicle recognition, and vehicle comparison functions. Updated the intelligent operation chapter. 	June 2019
V2.0.1	Added attention in important safeguards and warnings.	January 2019
V2.0.0	Updated figures of 16-HDD series IVSS.	December 2018
V1.0.0	First release.	November 2018







Privacy Protection Notice

















As the device user or data controller, you might collect the personal data of others such as their face, fingerprints, and license plate number. You need to be in compliance with your local privacy protection laws and regulations to protect the legitimate rights and interests of other people by implementing measures which include but are not limited: Providing clear and visible identification to inform people of the existence of the surveillance area and provide required contact information.

About the Manual

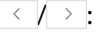
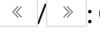
- The manual is for reference only. Slight differences might be found between the manual and the product.
- We are not liable for losses incurred due to operating the product in ways that are not in compliance with the manual.
- The manual will be updated according to the latest laws and regulations of related jurisdictions. For detailed information, see the paper user's manual, use our CD-ROM, scan the QR code or visit our official website. The manual is for reference only. Slight differences might be found between the electronic version and the paper version.
- All designs and software are subject to change without prior written notice. Product updates might result in some differences appearing between the actual product and the manual. Please contact customer service for the latest program and supplementary documentation.
- There might be errors in the print or deviations in the description of the functions, operations and technical data. If there is any doubt or dispute, we reserve the right of final explanation.
- Upgrade the reader software or try other mainstream reader software if the manual (in PDF format) cannot be opened.
- All trademarks, registered trademarks and company names in the manual are properties of their respective owners.
- Please visit our website, contact the supplier or customer service if any problems occur while using the device.
- If there is any uncertainty or controversy, we reserve the right of final explanation.

Icons and Buttons

Icon/Button	Description
	After you have entered password, click the icon, you can see the password is displayed in letters and number. Release mouse or move pointer to other places, the password is displayed in the form of black dots.
	Add icon. Click the icon, system can display the hidden APPLICATIONS window. You can view or open the applications.
	Help information. Point to the icon, device can display help information.
	Display or hide icon. Click the icon to display the hidden menu. Now the icon is shown as  . Click  again to hide the menu items.
	Check the box. You can select multiple menu items at the same time. <input checked="" type="checkbox"/> means selected.

Icon/Button	Description
	Check the box to select one menu item,  means selected.
	Drop-down box. Click the box to view the drop-down menu.
	Enable icon. <ul style="list-style-type: none"> • : Disabled. • : Enabled • : The function cannot be enabled. • : The function cannot be disabled.
	Click to clear all search criteria settings.
	Page switch. <ul style="list-style-type: none"> • : Page up/page down. • : Go to the first page or the last page.
	Filter icon. Click the icon to set filter criteria.
	Select icon. Click the icon, the system displays a checkbox, so you can select multiple objects.
	Search column. Enter key words, click  to search the corresponding information.
	Text column. Enter number, letter, symbol and so on.
	Close button. Click the icon to close the window.

Important Safeguards and Warnings

This section introduces content covering the proper handling of the Device, hazard prevention, and prevention of property damage. Read carefully before using the Device, comply with the guidelines when using it, and keep the manual safe for future reference.

Operation Requirements



- This is a class A product. In a domestic environment this may cause radio interference in which case you may be required to take adequate measures.
- The Device is heavy and needs to be carried by several persons together to avoid personal injuries.



- Check whether the power supply is correct before use.
- Do not unplug the power cord on the side of the Device while the adapter is powered on.
- Operate the Device within the rated range of power input and output.
- Use the Device under allowed humidity and temperature conditions.
- Do not drop or splash liquid onto the Device, and make sure that there is no object filled with liquid on the Device to prevent liquid from flowing into it.
- Do not disassemble the Device without professional instruction.
- Your configurations will be lost after performing a factory reset. Please be advised.
- Do not restart, shut down or disconnect the power to the Device during an update.
 - ◇ Make sure the update file is correct because an incorrect file can result in a Device error occurring.
 - ◇ The system cannot upgrade different types of AI modules at the same time.
- Do not frequently turn on/off the Device. Otherwise, the product life might be shortened.
- Back up important data on a regular basis when using the Device.
- Operating temperature: 0 °C to 45 °C (32 °F to 113 °F).
- Salt spray in the operating environment of the device might corrode its electronic components and cables. To ensure the normal operation of the device and prolong its service life, use the device in an indoor environment that is 3 kilometers away from the sea.

Installation Requirements



- Do not connect the power adapter to the Device while the adapter is powered on.
- Strictly comply with the local electric safety code and standards. Make sure the ambient voltage is stable and meets the power supply requirements of the Device.
- Do not expose the battery to environments with extremely low air pressure, or extremely high or low temperatures. Also, it is strictly prohibited for the battery to be thrown into a fire or furnace, and to cut or put mechanical pressure on the battery. This is to avoid the risk of fire and explosion.
- Use the standard power adapter or cabinet power supply. We will assume no responsibility for

any injuries or damages caused by the use of a nonstandard power adapter.



- Do not place the Device in a place exposed to sunlight or near heat sources.
- Keep the Device away from dampness, dust, and soot.
- Put the Device in a well-ventilated place, and do not block its ventilation.
- Install the server on a stable surface to prevent it from falling.
- The power supply must conform to the requirements of ES1 in IEC 62368-1 standard and be no higher than PS2. Note that the power supply requirements are subject to the Device label.
- The Device is a class I electrical appliance. Make sure that the power supply of the Device is connected to a power socket with protective earthing.
- Use power cords that conform to your local requirements, and are rated specifications.
- Before connecting the power supply, make sure the input voltage matches the server power requirement.
- When installing the Device, make sure that the power plug and appliance coupler can be easily reached to cut off power.
- Install the server in an area that only professionals can access.
- Extra protection is necessary for the Device casing to reduce the transient voltage to the defined range.
- If you did not push the HDD box to the bottom, then do not close the handle to avoid damage to the HDD slot.
- Install the Device near a power socket for emergency disconnect.
- It is prohibited for non-professionals and unauthorized personnel to open the Device casing.
- Affix the Device securely to the building before use.

Maintenance Requirements



- Make sure to use the same model when replacing the battery to avoid fire or explosion. Dispose the battery strictly according to the instructions on it.
- Power off the Device before maintenance.



- AI module does not support hot plug. If you need to install or replace the AI module, unplug the Device power cord first. Otherwise, it will lead to file damage on the AI module.
- The Device casing provides protection for internal components. Use a screwdriver to loosen the screws before detaching the casing. Make sure to put the casing back on and secure it in its original place before powering on and using the Device.
- It is prohibited for non-professionals and unauthorized personnel to open the Device casing.
- The appliance coupler is a disconnection Device. Keep it at a convenient angle when using it. Before repairing or performing maintenance on the Device, first disconnect the appliance coupler.

Transportation Requirements



Transport the Device under allowed humidity and temperature conditions.

Storage Requirements



Store the Device under allowed humidity and temperature conditions.

Table of Contents

Foreword.....	I
Important Safeguards and Warnings.....	V
1 Overview	1
1.1 Introduction.....	1
1.2 Login Mode	1
2 The Grand Tour	2
2.1 8-HDD Series.....	2
2.1.1 Front Panel	2
2.1.2 Rear Panel.....	3
2.1.3 Dimensions.....	5
2.2 12-HDD Series.....	5
2.2.1 Front Panel	5
2.2.2 Rear Panel.....	6
2.2.3 Dimensions.....	9
2.3 16-HDD Series.....	9
2.3.1 Front Panel	9
2.3.2 Rear Panel.....	11
2.3.3 Dimensions.....	15
2.4 24-HDD Series.....	16
2.4.1 Front Panel	16
2.4.2 Rear Panel.....	17
2.4.3 Dimensions.....	21
3 Hardware Installation	23
3.1 Installation Flow	23
3.2 Unpacking the Box	23
3.3 HDD Installation.....	24
3.3.1 8-HDD Series.....	24
3.3.2 12-HDD Series	26
3.3.3 16/24-HDD Series	27
3.4 Cable Connection.....	28
3.4.1 Alarm Connection	29
3.4.1.1 Connection	29
3.4.1.2 Alarm Port	30
3.4.1.3 Alarm Input.....	31
3.4.1.4 Alarm Output.....	32

3.4.2 Connection Diagram.....	33
4 Starting the Device	34
5 Initial Settings.....	35
5.1 Initializing Device.....	35
5.2 Quick Settings.....	37
5.2.1 Configuring IP Address.....	37
5.2.2 Configuring P2P Settings	39
5.3 Login.....	40
5.3.1 Logging in to PCAPP Client	40
5.3.2 Logging in to Local Interface.....	42
5.3.2.1 Preparation	43
5.3.2.2 Operation Steps.....	43
5.3.3 Logging in to Web Interface	43
5.4 Configuring Remote Device.....	44
5.4.1 Initializing Remote Device	44
5.4.2 Adding Remote Device.....	48
5.4.2.1 Smart Add.....	48
5.4.2.2 Manual Add	51
5.4.2.3 RTSP	53
5.4.2.4 Batch Add	54
6 AI Operations.....	57
6.1 Overview.....	57
6.2 Face Detection.....	58
6.2.1 Enabling AI Plan	58
6.2.2 Configuring Face Detection	58
6.2.3 Live View of Face Detection.....	60
6.2.3.1 Setting AI Display	60
6.2.3.2 Live View	61
6.2.3.3 Face Records	62
6.2.4 Face Search.....	63
6.2.4.1 Searching by Property.....	63
6.2.4.2 Searching by Image.....	66
6.2.4.2.1 Searching Devices.....	66
6.2.4.2.2 Searching Face Database.....	69
6.2.4.2.3 Searching Task Lists.....	70
6.2.4.3 Exporting Face Records	71
6.3 Face Recognition.....	73
6.3.1 Configuration Modes.....	73

6.3.2 Face Recognition by Camera	73
6.3.2.1 Configuration Procedure	73
6.3.2.2 Enabling AI Plan	73
6.3.2.3 Configuring Remote Face Database.....	73
6.3.2.3.1 Creating Face Database for Remote Devices	73
6.3.2.3.2 Adding Face Images for Remote Devices.....	75
6.3.2.4 Configuring Face Recognition (by Camera)	78
6.3.2.5 Live View of Face Recognition	79
6.3.2.5.1 Setting AI Display.....	79
6.3.2.5.2 Live View	80
6.3.2.5.3 Face Total.....	81
6.3.2.6 Face Search.....	82
6.3.2.6.1 Searching by Property	82
6.3.2.6.2 Searching by Property	84
6.3.2.6.3 Searching by Image	84
6.3.2.6.4 Exporting Face Records	84
6.3.2.6.5 1:1 Face Recognition	84
6.3.3 Face Detection by Camera + Face Recognition by Device	85
6.3.3.1 Configuration Procedure	85
6.3.3.2 Enabling AI Plan	85
6.3.3.3 Configuring Face Detection (by Camera)	85
6.3.3.4 Configuring Device Face Database.....	87
6.3.3.4.1 Creating Human Face Database	87
6.3.3.4.2 Exporting Face Database	88
6.3.3.4.3 Adding Face Image	89
6.3.3.4.4 Creating Passerby Database	94
6.3.3.4.5 Human Face Abstract.....	96
6.3.3.4.6 Managing Face Pictures.....	97
6.3.3.5 Configuring Face Recognition (by Device)	98
6.3.3.6 Live View	100
6.3.3.7 Face Search.....	100
6.3.4 Face Recognition by Camera + Face Recognition by Device.....	100
6.3.4.1 Configuration procedure	100
6.3.4.2 Enabling AI Plan	101
6.3.4.3 Configuring Face Recognition (by Camera)	101
6.3.4.4 Configuring Device Face Database.....	101
6.3.4.5 Configuring Face Recognition (by Device)	101
6.3.4.6 Live View	101

6.3.4.7 Face Search	101
6.3.5 Face Detection by Device + Face Recognition by Device	101
6.3.5.1 Configuration Procedure	101
6.3.5.2 Configuring Face Detection (by Device)	101
6.3.5.3 Configuring Device Face Database	103
6.3.5.4 Configuring Face Recognition (by Device)	103
6.3.5.5 Live View	103
6.3.5.6 Face Search	103
6.3.6 Video Metadata + Face Recognition by Device	103
6.3.6.1 Configuration Procedure	103
6.3.6.2 Enabling AI Plan	104
6.3.6.3 Configuring Video Metadata	104
6.3.6.4 Configuring Face Recognition (by Device)	104
6.3.6.5 Live View	104
6.3.6.6 Face Search	104
6.4 People Counting	104
6.4.1 Enabling AI Plan	104
6.4.2 Configuring People Counting	105
6.4.3 Configuring In Area No.	106
6.4.4 Configuring Queuing Detection	107
6.4.5 Live View	108
6.4.6 Viewing AI Report	109
6.5 Video Metadata	111
6.5.1 Enabling AI Plan	111
6.5.2 Configuring Video Metadata	111
6.5.3 Live View of Video Metadata	113
6.5.3.1 Setting AI Display	113
6.5.3.2 Live View	114
6.5.3.3 Detection Statistics	115
6.5.3.3.1 Human	115
6.5.3.3.2 Motor Vehicle	116
6.5.3.3.3 Non-motor Vehicle	116
6.5.4 AI Search	117
6.5.4.1 Human Search	117
6.5.4.1.1 Searching by Property	117
6.5.4.1.2 Searching by Image	120
6.5.4.2 Vehicle Search	125
6.5.4.3 Non-motor Vehicle Search	127

6.6 IVS	129
6.6.1 Enabling AI Plan	129
6.6.2 Configuring IVS.....	129
6.6.2.1 Switching IVS Model.....	129
6.6.2.2 Global Configuration	129
6.6.2.3 Rule Configuration	130
6.6.3 Live View of IVS	134
6.6.3.1 Setting AI Display	134
6.6.3.2 Live View	136
6.6.3.3 Detection Statistics.....	136
6.6.4 IVS Search.....	137
6.7 Vehicle Recognition	138
6.7.1 Enabling AI Plan	138
6.7.2 Setting Vehicle Recognition.....	138
6.7.3 Live View of Vehicle Recognition	139
6.7.3.1 Setting AI Display	139
6.7.3.2 Live View	140
6.7.3.3 Detection Statistics.....	141
6.7.4 Searching for Detection Information	142
6.8 ANPR.....	142
6.8.1 Procedure	142
6.8.2 Setting Vehicle Detection	142
6.8.3 Configuring Vehicle Database	142
6.8.3.1 Creating Vehicle Database.....	142
6.8.3.2 Registering Vehicle Information	144
6.8.3.2.1 Manual Add.....	144
6.8.3.2.2 Batch Import.....	145
6.8.3.2.3 Adding from Detection Results.....	147
6.8.3.3 Managing Vehicle Information	147
6.8.3.3.1 Editing Vehicle Information.....	148
6.8.3.3.2 Copying Vehicle Information	148
6.8.3.3.3 Deleting Vehicle Information.....	149
6.8.4 Configuring Number Plate Comparison.....	149
6.8.5 Live View of ANPR	150
6.8.5.1 Setting AI Display	150
6.8.5.2 Live View	151
6.8.5.3 Detection Statistics.....	152
6.8.6 AI Search	153

6.8.6.1 Searching by Property	153
6.8.6.2 Searching by Database	155
6.9 Crowd Distribution Map	156
6.9.1 Enabling AI Plan	157
6.9.2 Configuring Crowd Distribution Map.....	157
6.9.2.1 Global Configuration	157
6.9.2.2 Rule Configuration	157
6.9.3 Live View of Crowd Distribution	158
6.10 Call Alarm	159
6.10.1 Enabling AI Plan.....	159
6.10.2 Configuring Call Alarm.....	159
6.10.3 Live View of Call Alarm.....	160
6.10.4 Call Alarm Search	161
6.11 Smoking Alarm	162
6.11.1 Enabling AI Plan.....	163
6.11.2 Configuring Smoking Alarm	163
6.11.3 Live View of Smoking Alarm.....	164
7 General Operations.....	165
7.1 Live and Monitor	165
7.1.1 View Management.....	166
7.1.1.1 View Group	167
7.1.1.1.1 Creating View Group	167
7.1.1.1.2 Operation	168
7.1.1.2 View	169
7.1.1.2.1 Creating View	169
7.1.1.2.2 Editing View	172
7.1.1.2.3 Enabling view.....	173
7.1.1.3 View Window	175
7.1.1.3.1 Task Column	175
7.1.1.3.2 Shortcut Menu.....	177
7.1.1.3.3 Digital Zoom.....	178
7.1.1.3.4 Searching by Image	179
7.1.1.3.5 Fisheye Dewarp.....	179
7.1.1.3.6 Smart Tracking	181
7.1.1.3.7 Thermal	181
7.1.1.3.8 Talk.....	182
7.1.2 Resources Pool.....	183
7.1.3 PTZ.....	184

7.1.3.1 PTZ Menu Settings	186
7.1.3.2 Configuring PTZ Functions	187
7.1.3.2.1 Setting a Preset	187
7.1.3.2.2 Setting a Cruise	189
7.1.3.2.3 Setting a Pattern.....	189
7.1.3.2.4 Setting Linear Scanning.....	190
7.1.3.2.5 Enabling Auxiliary Functions.....	191
7.2 Recorded Files.....	191
7.2.1 Playing Back Recorded Video	191
7.2.2 Clipping Recorded Video.....	196
7.2.3 Playing Back Snapshots.....	197
7.2.4 Exporting File	200
7.2.5 Video Tag.....	202
7.2.6 Locking Files	203
7.3 File Management	203
7.3.1 Face Management.....	203
7.3.2 Vehicle Management.....	204
7.3.3 Tag Management.....	204
7.3.4 File Lock	204
7.3.5 Voice Management.....	205
7.3.6 Watermark Verification.....	206
7.4 Task Management.....	207
7.4.1 AI Analysis Task	207
7.4.1.1 Configuration Procedure	207
7.4.1.2 Importing Task Resources	208
7.4.1.3 Creating AI Analysis Task.....	208
7.4.1.4 Viewing Analysis Results.....	210
7.4.2 Extracting Eigenvector Again.....	210
7.5 Backup	211
7.6 Alarm List	213
7.7 Display Management	214
7.7.1 Multiple-screen Control	214
7.7.2 Locking Screen.....	216
7.8 System Info.....	216
7.9 Background Task	217
7.10 Buzzer	217
8 System Configuration.....	218
8.1 Configuration Window.....	218

8.2 Device Management	218
8.2.1 Viewing Device Information	219
8.2.2 Remote Device	221
8.2.2.1 Viewing Remote Devices	221
8.2.2.2 Changing IP Address	221
8.2.2.2.1 Modifying IP of Unconnected Devices	222
8.2.2.2.2 Modifying IP of Connected Devices	223
8.2.2.3 Configuring Remote Devices	224
8.2.2.3.1 Configuring Device Property	225
8.2.2.3.2 Configuring Connection Information	225
8.2.2.3.3 Configuring Video Parameters	227
8.2.2.3.4 Configuring OSD	228
8.2.2.3.5 Configuring Audio Parameters	230
8.2.2.4 Exporting Remote Devices in Batches	231
8.2.2.5 Importing Remote Devices in Batches	232
8.2.2.6 Connecting Remote Devices	232
8.2.2.7 Deleting Remote Devices	232
8.2.2.8 Changing Device Password	233
8.3 Network Management	233
8.3.1 Basic Network	234
8.3.1.1 Configuring IP Address	234
8.3.1.2 Port Aggregation	236
8.3.1.2.1 Binding NIC	237
8.3.1.2.2 Cancelling Binding NIC	239
8.3.1.3 Setting Port Number	239
8.3.2 Network Apps	240
8.3.2.1 P2P	240
8.3.2.2 DDNS	241
8.3.2.2.1 Preparation	241
8.3.2.2.2 Procedure	242
8.3.2.3 Email	243
8.3.2.4 SNMP	244
8.3.2.5 Register	246
8.3.2.6 UPnP	247
8.3.2.7 Multicast	249
8.3.2.8 Alarm Center	250
8.3.2.9 Route Table	250
8.4 Event Management	251

8.4.1 Alarm Actions	251
8.4.1.1 Record	253
8.4.1.2 Buzzer	253
8.4.1.3 Log	254
8.4.1.4 Email	254
8.4.1.5 Preset	254
8.4.1.6 Snapshot	255
8.4.1.7 Local Alarm Out	255
8.4.1.8 Remote Device Alarm Output	255
8.4.1.9 Access	256
8.4.1.10 Voice Prompt	256
8.4.1.11 Smart Tracking	256
8.4.1.12 Report Alarm	257
8.4.1.13 Audio and Light Alarm	257
8.4.2 Local Device	258
8.4.2.1 One-click Disarming	258
8.4.2.2 Abnormal Event	259
8.4.2.3 Offline Alarm	260
8.4.2.4 Configuring AI Application	261
8.4.2.4.1 Viewing AI Plan	261
8.4.2.4.2 Setting AI Display	262
8.4.2.4.3 Setting Entries Frequency	264
8.4.2.4.4 Video Diagnosis	265
8.4.2.5 Configuring Device Alarm	267
8.4.3 Remote Device	268
8.4.3.1 Video Detection	268
8.4.3.1.1 Configuring Video Motion	268
8.4.3.1.2 Tampering	270
8.4.3.2 Offline Alarm	271
8.4.3.3 IPC External Alarm	271
8.4.3.4 Thermal Alarm	272
8.5 Storage Management	273
8.5.1 Storage Resource	274
8.5.1.1 Local Hard Disk	274
8.5.1.1.1 Viewing S.M.A.R.T.	274
8.5.1.1.2 Format	275
8.5.1.1.3 File System Repair	275
8.5.1.2 RAID	275

8.5.1.2.1 Creating RAID.....	276
8.5.1.2.2 Creating Hot Spare HDD.....	280
8.5.1.3 Network Hard Disk.....	282
8.5.1.3.1 iSCSI Application.....	282
8.5.1.3.2 iSCSI Management.....	283
8.5.2 Video Recording.....	285
8.5.2.1 Storage Mode.....	285
8.5.2.1.1 Setting Disk Group.....	285
8.5.2.1.2 Setting Video/Image Storage.....	286
8.5.2.2 Recording Schedule.....	288
8.5.2.2.1 Recording Mode.....	288
8.5.2.2.2 Recording Schedule.....	289
8.5.2.3 Basic.....	291
8.5.2.3.1 Setting Storage Mode.....	291
8.5.2.3.2 Setting Automatic File Deletion.....	291
8.5.2.4 Record Transfer.....	292
8.6 Security Strategy.....	292
8.6.1 HTTPS.....	293
8.6.1.1 Installing Certificate.....	293
8.6.1.1.1 Installing the Created Certificate.....	293
8.6.1.1.2 Installing Signature Certificate.....	294
8.6.1.2 Enabling HTTPS.....	295
8.6.1.3 Uninstalling the Certificate.....	295
8.6.2 Configuring Access Permission.....	296
8.6.3 Safety Protection.....	297
8.6.4 Enabling System Service.....	298
8.6.5 Configuring Firewall.....	300
8.6.6 Configuring Time Synchronization Permission.....	300
8.7 Account Management.....	301
8.7.1 User Group.....	301
8.7.1.1 Adding User Group.....	302
8.7.1.2 Deleting User Group.....	303
8.7.2 Device User.....	303
8.7.2.1 Adding a User.....	303
8.7.2.2 Operation.....	305
8.7.3 Password Maintenance.....	305
8.7.3.1 Changing Password.....	305
8.7.3.1.1 Changing Password of the Current User.....	306

8.7.3.1.2 Changing Password of Other User	306
8.7.3.2 Resetting Password	307
8.7.3.2.1 Leaving Email Address and Security Questions.....	307
8.7.3.2.2 Resetting Password on Local Interface	307
8.7.3.2.3 Resetting Password on the Web.....	310
8.7.4 ONVIF.....	312
8.7.4.1 Adding ONVIF User	312
8.7.4.2 Deleting ONVIF User.....	313
8.8 System Configuration	314
8.8.1 Setting System Parameters.....	314
8.8.2 System Time.....	315
8.8.3 Display	317
8.8.4 Schedule	318
8.9 Cluster Service	319
8.9.1 Configuring Cluster	319
8.9.1.1 Creating a Cluster	319
8.9.1.2 Viewing Details	321
8.9.1.3 Configuring Arbitration IP.....	322
8.9.2 Record Synchronization	322
8.9.3 Viewing Cluster Log	323
9 System Maintenance.....	324
9.1 Overview.....	324
9.2 System Information.....	325
9.2.1 Viewing Device Information	325
9.2.2 Viewing Legal Information	326
9.2.3 Viewing Algorithm Version.....	326
9.3 System Resources.....	327
9.3.1 Viewing Device Resource	327
9.3.2 Viewing AI Module Information	327
9.4 Logs.....	328
9.4.1 Log Classification.....	328
9.4.2 Log Search	328
9.5 Intelligent Diagnosis	329
9.5.1 Run Log	329
9.5.2 One-click Export.....	330
9.6 Network Care.....	330
9.6.1 Online User	330
9.6.2 Packet Capture.....	331

9.7 Device Maintenance	332
9.7.1 Updating Device	332
9.7.1.1 Updating the Device	332
9.7.1.2 Updating AI Module	332
9.7.1.3 Updating Cameras.....	333
9.7.2 Default	333
9.7.3 Automatic Maintenance.....	334
9.7.4 IMP/EXP	334
9.8 Disk Maintenance.....	335
9.8.1 S.M.A.R.T Detection	335
9.8.2 SSD Health Detection	335
9.8.3 Firmware Update	336
10 PCAPP Introduction.....	337
10.1 Page Description.....	337
10.2 History Record.....	337
10.3 Viewing Downloads	337
10.4 Configuring PCAPP	338
10.5 Viewing Version Details.....	339
11 Log Out, Reboot, Shut Down, Lock	340
12 FAQ.....	342
Appendix 1 Glossary	343
Appendix 2 Mouse and Keyboard Operations	345
Appendix 2.1 Mouse Operations.....	345
Appendix 2.2 Virtual Keyboard.....	346
Appendix 3 RAID	348
Appendix 4 HDD Capacity Calculation	350
Appendix 5 Particulate and Gaseous Contamination Specifications	351
Appendix 5.1 Particulate Contamination Specifications	351
Appendix 5.2 Gaseous Contamination Specifications	351
Appendix 6 Cybersecurity Recommendations.....	353

1 Overview

1.1 Introduction

As an intelligent video surveillance server (hereinafter referred to as IVSS or the Device), IVSS delivers not only the basic video surveillance functions, but also a bunch of advanced AI features including face recognition, perimeter protection, video metadata and ANPR, providing AI-based all-in-one surveillance solution for customers.

- General functions: Video surveillance, video storage, alarm, record search and playback, intelligent analysis features.
- User-friendly interface.
- 4K and H.265 decoding.
- Applicable to scenarios such as intelligent building, large parking lot, financial planning area and more.

1.2 Login Mode

You can operate the device by using the local interface, web client and PCAPP client (the PC client, hereinafter referred to as PCAPP).



Operation and system configuration in this manual is mainly based on PCAPP. There might be differences from local or web operation.

Table 1-1 Login mode

Login Mode	Operation	Description
Local	Connect the display, mouse and keyboard to the device. View and operate the local menu on the display.	Support all functions of the device.
Web	Connect the device and PC into the same network, and remotely access the device through browser (Google Chrome and Firefox) on PC.	Support majority functions of the device, except live, record playback, video download and other video-related functions.
PCAPP	Connect the device and PC into the same network, download and install PCAPP on PC, and then remotely access the device with PCAPP.	Support all functions of the device.

2 The Grand Tour

This section introduces front panel, rear panel, port function and button function, indicator light status, and so on.

2.1 8-HDD Series

2.1.1 Front Panel

Figure 2-1 Front panel

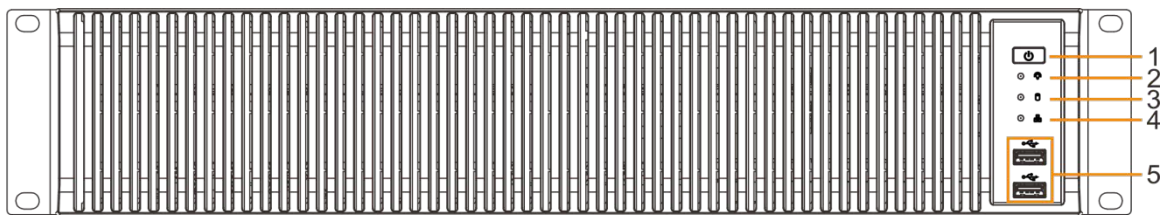

Table 2-1 Front panel description

No.	Button/Port	Description
1	Power	Boot up or shut down device. Power indicator light status is as follows: <ul style="list-style-type: none"> When device is off (indicator light is off), press the button for a short period to boot up device. When device is running, (blue indicator light is on), press the button for at least 4 seconds to shut down the device.
2	Alarm indicator light	Displays local input alarm status. <ul style="list-style-type: none"> The indicator light is off: There is no local alarm input event. Red indicator light is on: There is local alarm input event.
3	System status indicator light	Displays the system running status. <ul style="list-style-type: none"> The blue light is on: Device is running properly. The indicator light is off: The device is not running.
4	Network indicator light	Displays current network status. <ul style="list-style-type: none"> The indicator light is blue: It means at least one Ethernet port has connected to the network. The indicator light is off: No Ethernet ports are connected to the network.
5	USB	Connects to external devices such as USB storage device, keyboard and mouse.

2.1.2 Rear Panel

Figure 2-2 IVSS7008 rear panel

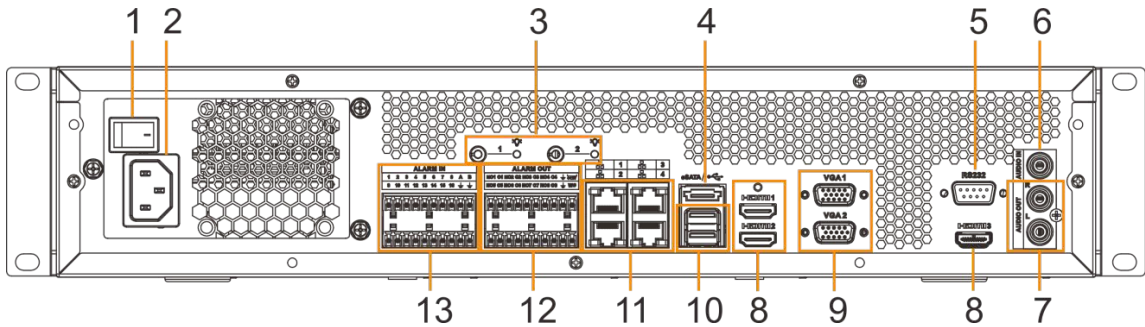

Figure 2-3 IVSS7008-M rear panel

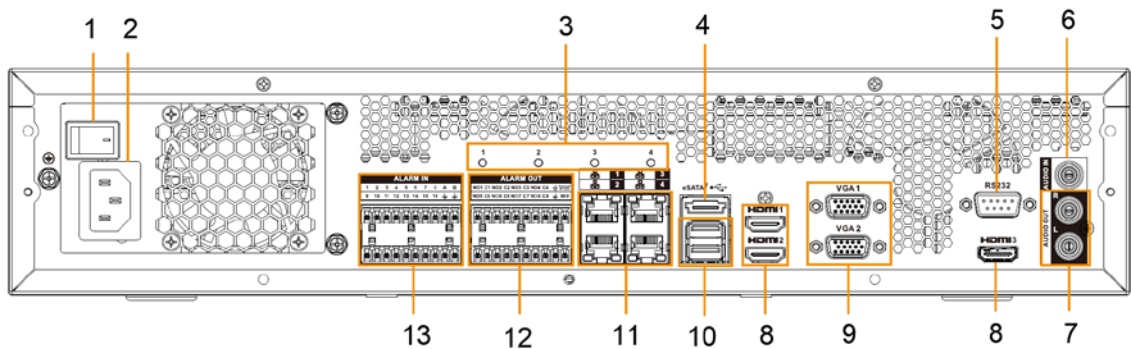

Figure 2-4 IVSS7108-M rear panel

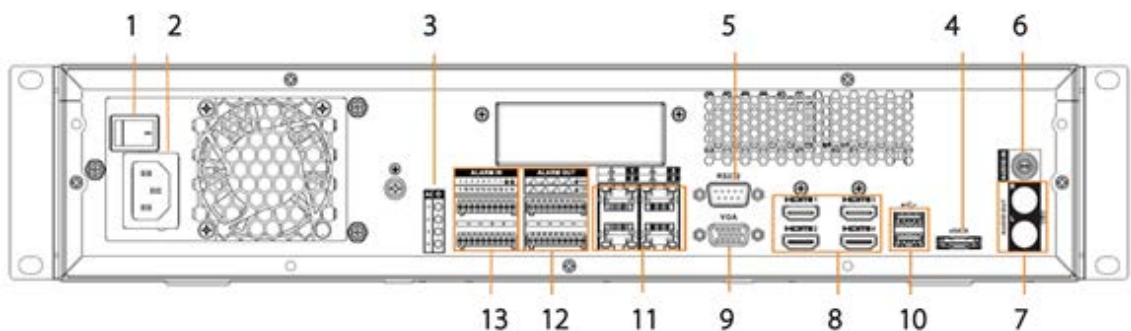



Table 2-2 Rear panel description

No.	Button/Port	Description
1	Power	Power on-off button.
2	Power input	Inputs 100–240 VAC power.
3	AI module indicator light	Displays AI module status. <ul style="list-style-type: none"> ● Yellow light flashes: AI module is running properly. ● Yellow light is on: AI module is malfunctioning.  This function is not available without AI module.
4	eSATA	SATA peripheral port. Connect to SATA port or eSATA device.
5	RS-232	RS-232 COM debug. It is for general COM debug, set IP address, transmit transparent COM data.

No.	Button/Port	Description
6	AUDIO IN	Audio input port.
7	AUDIO OUT	Audio output port.
8	HDMI	High definition audio and video signal output port. The port outputs the uncompressed high definition video and multi-channel audio data to the connected display with HDMI port. The HDMI ports are different source output.
9	VGA	VGA video output port. Output analog video signal. It can connect to the monitor to view analog video. The VGA ports are different source output. VGAn and HDMIIn are same source output. For example: <ul style="list-style-type: none"> • VGA1 and HDMI 1 are same source output. • VGA2 and HDMI 2 are same source output.
10	USB	Connects to external devices such as USB storage device, keyboard and mouse.
11	Network	10/100/1000 Mbps self-adaptive Ethernet port. Connect to the network cable.
12	Alarm output	8 groups of alarm output ports (NO1 C1–NO8 C8). Output alarm signal to the alarm device. Please make sure there is power to the external alarm device. <ul style="list-style-type: none"> • NO: Alarm output port of Normally Open type. • C: Common alarm output port. • \perp: GND end.
13	Alarm input	16 groups (1–16) alarm input ports, they are corresponding to ALARM 1–ALARM 16. The alarm becomes valid in low level. <ul style="list-style-type: none"> • A and B: Control the A/B cable of the RS–485 device. It is used to connect to the PTZ camera. Please parallel connect 120 Ω between A/B cables if there are too many PTZ decoders. • \perp: GND end.

2.1.3 Dimensions

Figure 2-5 Dimension (mm [inch])

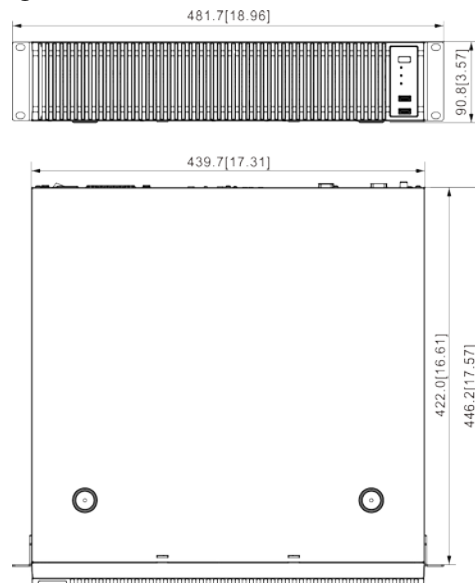

2.2 12-HDD Series

2.2.1 Front Panel

Figure 2-6 Front panel

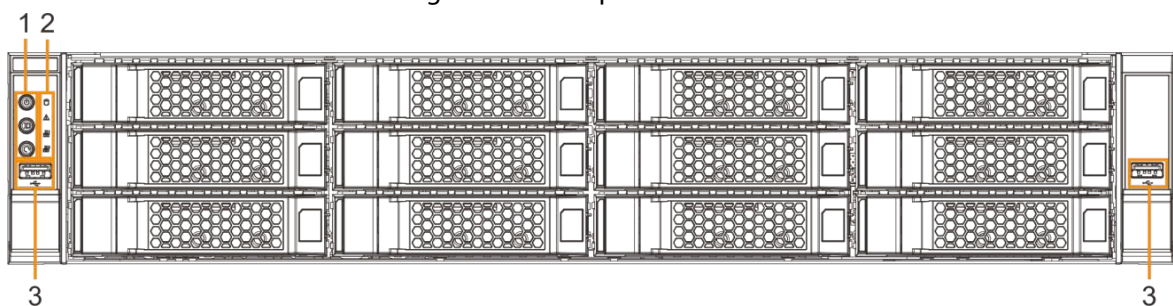



Table 2-3 Front panel description

No.	Button/Port	Description
1	Power	Boot up or shut down device. Power indicator light status is as follows: <ul style="list-style-type: none"> When device is off (indicator light is off), press the button for a short period to boot up device. When device is running, (blue indicator light is on), press the button for at least 4 seconds to shut down the device.
	ID button	Position button. It is to used control the ID indicator light on the rear panel to position the device.  ID button has the indicator light function. Its display status is the same with the ID indicator light on the rear panel.

No.	Button/Port	Description
	RESET button	Click to restart the device.
2	Power indicator light	Displays power status. <ul style="list-style-type: none"> • Amber light is on: The device has properly connected to the power source. • The indicator light is off: The device has not connected to the power source.
	Alarm indicator light	Displays local input alarm status. <ul style="list-style-type: none"> • Green light on: There is no local alarm input alarm. • Red indicator light is on: There is local alarm input event.
	Network indicator light 1	Displays network statuses of Ethernet port 1 and Ethernet port 2. <ul style="list-style-type: none"> • The indicator light flashes green: At least one Ethernet port has connected to the network. • The indicator light is off: All Ethernet ports are not connected to the network.
	Network indicator light 2	Displays network statuses of Ethernet port 3 and Ethernet port 4. <ul style="list-style-type: none"> • The indicator light flashes green: At least one Ethernet port has connected to the network. • The indicator light is off: All Ethernet ports are not connected to the network.
3	USB port	Connects to external devices such as USB storage device, keyboard and mouse.

2.2.2 Rear Panel

Figure 2-7 IVSS7012 rear panel (the single-power series)

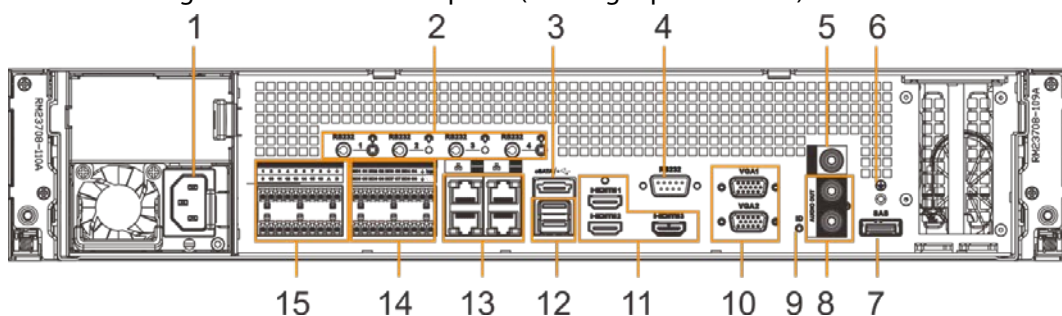

Figure 2-8 IVSS7012 rear panel (the redundant series)

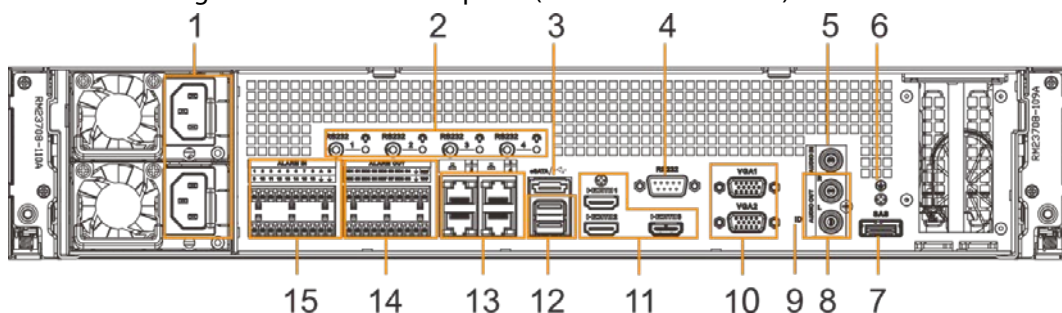

Figure 2-9 IVSS7012-M rear panel

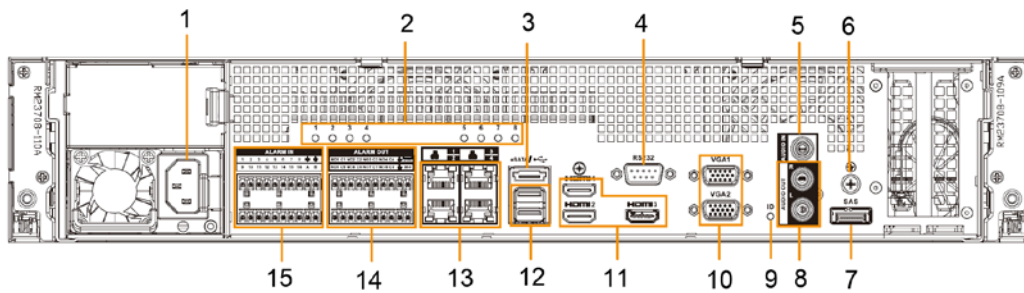

Figure 2-10 IVSS7112 rear panel (the single-power series)

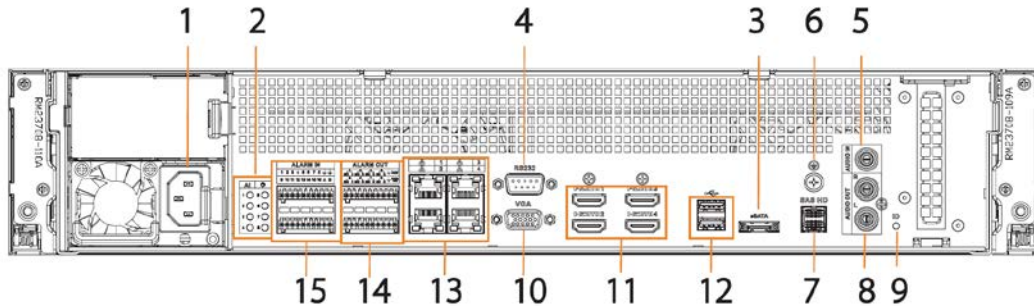

Figure 2-11 IVSS7112 rear panel (the redundant series)

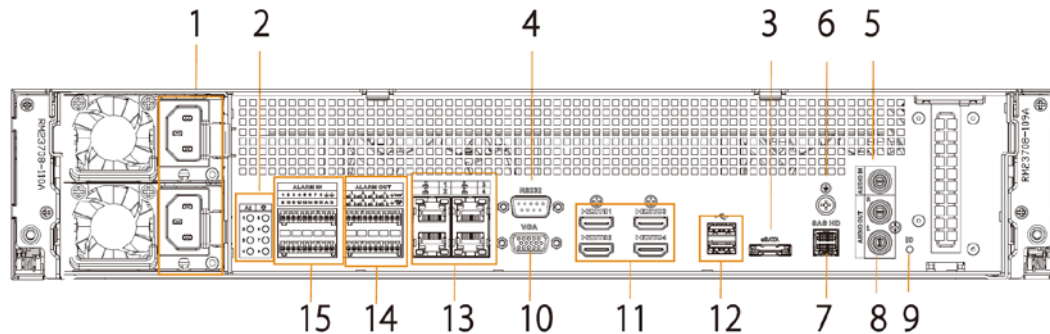



Table 2-4 Rear panel description

No.	Name	Description
1	Power input port	Inputs 100–240 VAC power.
2	AI module indicator light	Displays AI module status. <ul style="list-style-type: none"> The yellow light flashes: AI module is running properly. The yellow light is on: AI module is malfunctioning.  This function is not available without AI module.
3	eSATA port	SATA peripheral port. Connect to SATA port or eSATA device.
4	RS-232 port	RS-232 COM debug. It is for general COM debug, set IP address, transmit transparent COM data.
5	AUDIO IN	Audio input port.
6	GND	Ground port.

No.	Name	Description
7	SAS port	SAS extension port. It can connect to the SAS extension controller.
8	AUDIO OUT	Audio output port.
9	ID indicator light	Positioning indicator light. It is controlled by the ID button on the front panel. <ul style="list-style-type: none"> • The blue light is on, device is positioning now. • The indicator light is off: The device is not positioning.
10	VGA port	VGA video output port. Output analog video signal. It can connect to the monitor to view analog video. The VGA ports are different source output. VGAn and HDMI _n are same source output. For example: <ul style="list-style-type: none"> • VGA1 and HDMI 1 are same source output. • VGA2 and HDMI 2 are same source output.
11	HDMI port	High definition audio and video signal output port. The port outputs the uncompressed high definition video and multi-channel audio data to the connected display with HDMI port. The HDMI ports are different source output.
12	USB port	Connects to external devices such as USB storage device, keyboard and mouse.
13	Network port	10/100/1000 Mbps self-adaptive Ethernet port. Connect to the network cable.
14	Alarm output	8 groups of alarm output ports (NO1 C1–NO8 C8). Output alarm signal to the alarm device. Please make sure there is power to the external alarm device. <ul style="list-style-type: none"> • NO: Alarm output port of Normally Open type. • C: Common alarm output port. • \perp: GND end.
15	Alarm input	16 groups (1–16) alarm input ports, they are corresponding to ALARM 1–ALARM 16. The alarm becomes valid in low level. <ul style="list-style-type: none"> • A and B: Control the A/B cable of the RS–485 device. It is used to connect to the PTZ camera. Please parallel connect 120Ω between A/B cables if there are too many PTZ decoders. • \perp: GND end.

2.2.3 Dimensions

Figure 2-12 Dimensions (mm [inch])

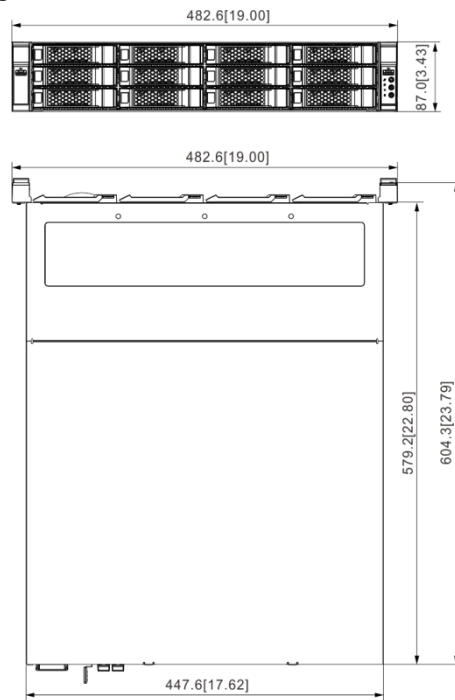

2.3 16-HDD Series



- The Device has an embedded display on select models.
- The Device has power redundancy on select models.

2.3.1 Front Panel

Figure 2-13 Front panel with LCD

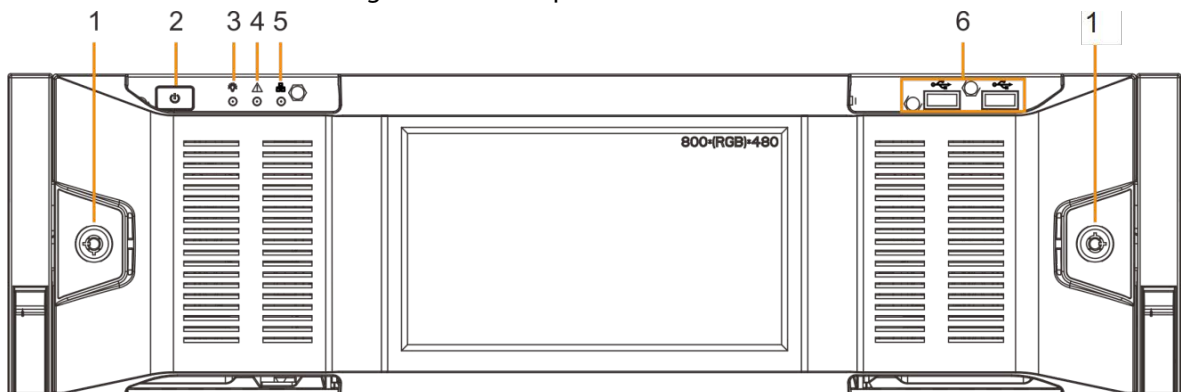

Figure 2-14 Front panel without LCD

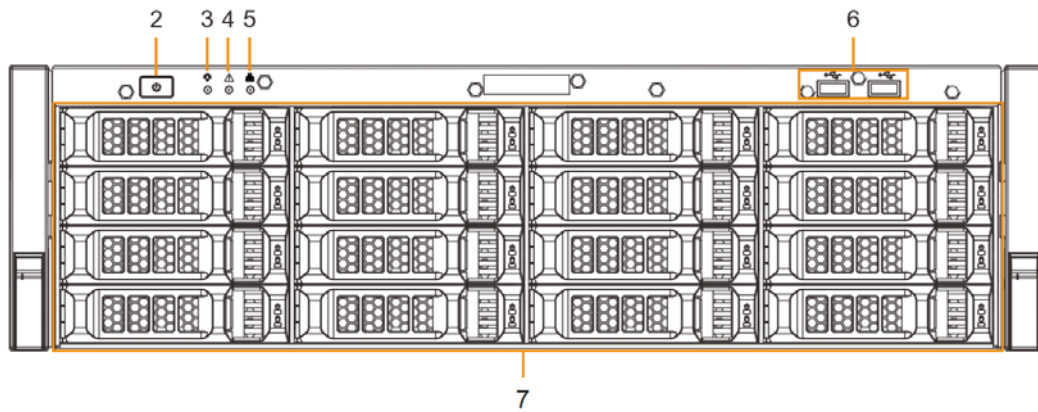

Table 2-5 Front panel description

No.	Button/Port	Description
1	Front panel lock	Once the front panel lock is secure, it can prevent HDD from being stolen or removed by mistake. Unlock the front panel lock and remove the front panel, you can view 16 HDD slots.
2	Power	Boot up or shut down device. The power on-off button has the indicator light. It can display device-running status. <ul style="list-style-type: none"> When device is off (indicator light is off), press the button for a short period to boot up device. When device is running, (blue indicator light is on), press the button for at least 4 seconds to shut down the device.
3	System status indicator light	Displays the system running status. <ul style="list-style-type: none"> The blue light is on: Device is running properly. The indicator light is off: The device is not running.
4	Alarm indicator light	Displays local input alarm status. <ul style="list-style-type: none"> Red indicator light is on: There is local alarm input event. The indicator light is off: There is no local alarm input event.
5	Network indicator light	Displays current network status. <ul style="list-style-type: none"> The indicator light is blue: It means at least one Ethernet port has connected to the network. The indicator light is off: No Ethernet ports are connected to the network.
6	USB port	Connects to external devices such as USB storage device, keyboard and mouse.
7	16-HDD slot	After you remove the front panel, you can see there are 16 HDDs. From the left to the right and from the top to the bottom, it ranges from 1–4, 5–8, 9–12, and 13–16. There are two indicator lights on the HDD slot: HDD indicator light and HDD read/write indicator light. <ul style="list-style-type: none"> : HDD indicator light. The light is yellow after you install the HDD. : Read/write indicator light. The blue light flashes when it is reading and writing data.

2.3.2 Rear Panel

Figure 2-15 IVSS7016 rear panel (single power)

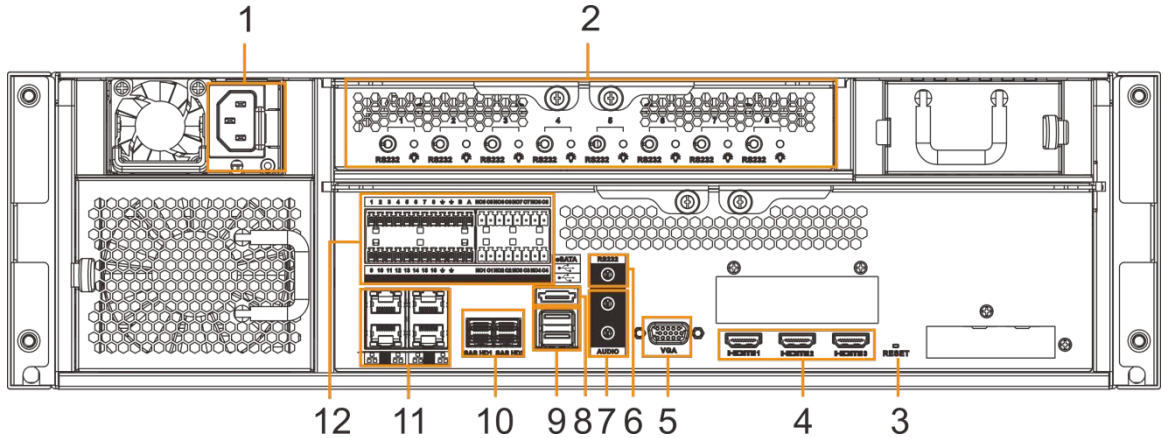

Figure 2-16 IVSS7016 rear panel (redundant power)

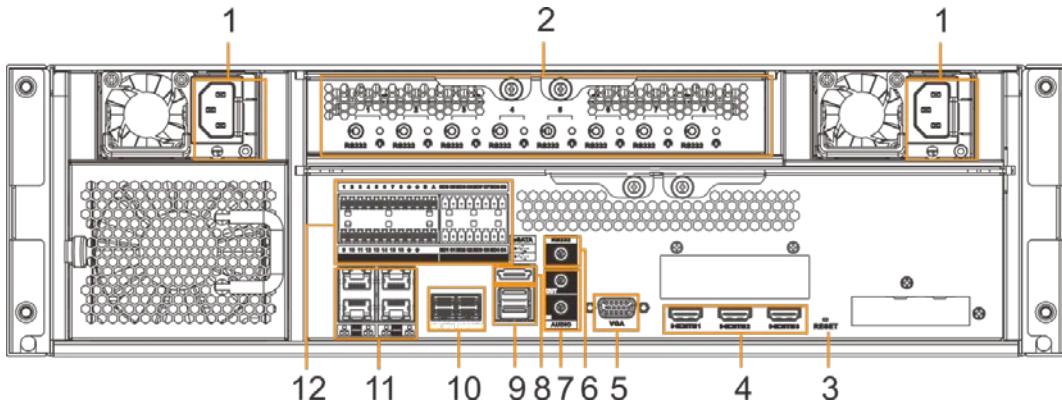

Figure 2-17 IVSS7016-M rear panel (single power)

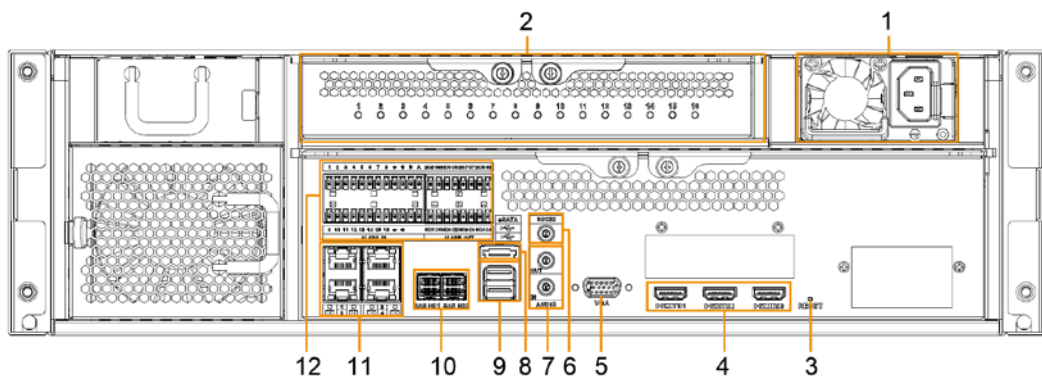

Figure 2-18 IVSS7016-M rear panel (redundant power)

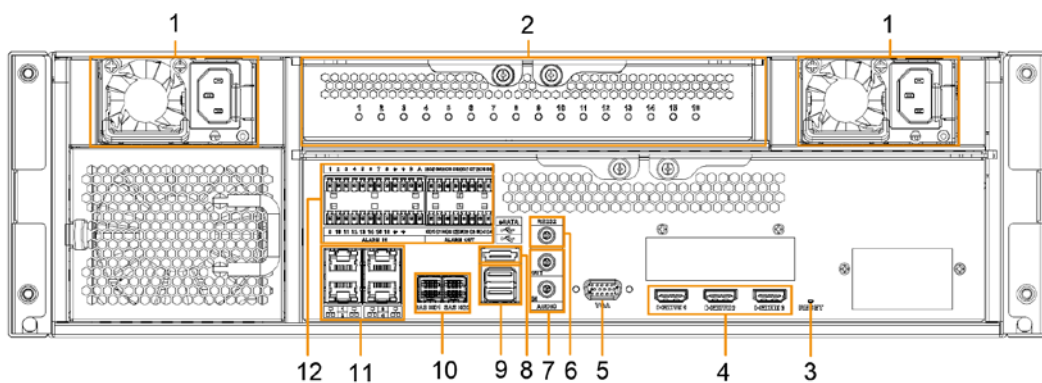



Table 2-6 IVSS7016 rear panel description

No.	Name	Description
1	Power input port	Inputs 100–240 VAC power.
2	AI module indicator light	Displays AI module status. <ul style="list-style-type: none"> The yellow light flashes: AI module is running properly. The yellow light is on: AI module is malfunctioning.  This function is valid if there is AI module.
3	RESET button	Reserved.
4	HDMI port	High definition audio and video signal output port. The port outputs the uncompressed high definition video and multi-channel audio data to the connected display with HDMI port. The three HDMI ports are different source output.
5	VGA port	VGA video output port. It outputs analog video signal. The VGA port and HDMI 1 port are same source output.
6	RS-232 port	RS-232 COM debug. It is used for general COM debug, setting IP address, and transmitting transparent COM data.
7	AUDIO IN	Audio input port
	AUDIO OUT	Audio output port
8	eSATA port	SATA peripheral port. Connects to SATA port or eSATA device.
9	USB port	Connects to external devices such as USB storage device, keyboard and mouse.
10	SAS port	SAS extension port. It can connect to the SAS extension controller.
11	Network port	10/100/1000 Mbps self-adaptive Ethernet port. Connects to the network cable.
12	Alarm Input	16 groups (1–16) alarm input ports. They are corresponding to ALARM 1–ALARM 16. The alarm becomes valid in low level. <ul style="list-style-type: none"> A and B: Control the A/B cable of the RS-485 device. It is used to connect to the PTZ camera. Please connect 120Ω between A/B cables if there are too many PTZ decoders. : GND end.

No.	Name	Description
	Alarm Output	<p>8 groups of alarm output ports (NO1 C1–NO8 C8). They output alarm signal to the alarm device. Please make sure there is power to the external alarm device.</p> <ul style="list-style-type: none"> • NO: Alarm output port of Normally Open type. • C: Common alarm output port. • \perp: GND end.

Figure 2-19 IVSS7116 rear panel (single power)

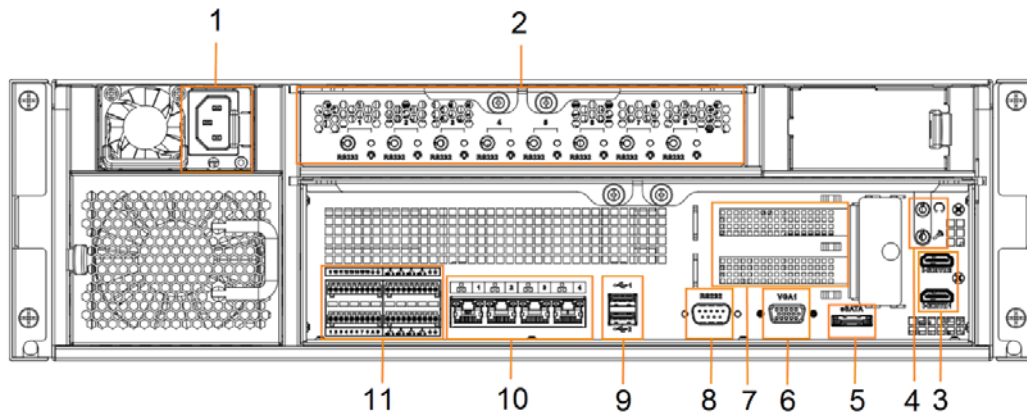

Figure 2-20 IVSS7116 rear panel (redundant power)

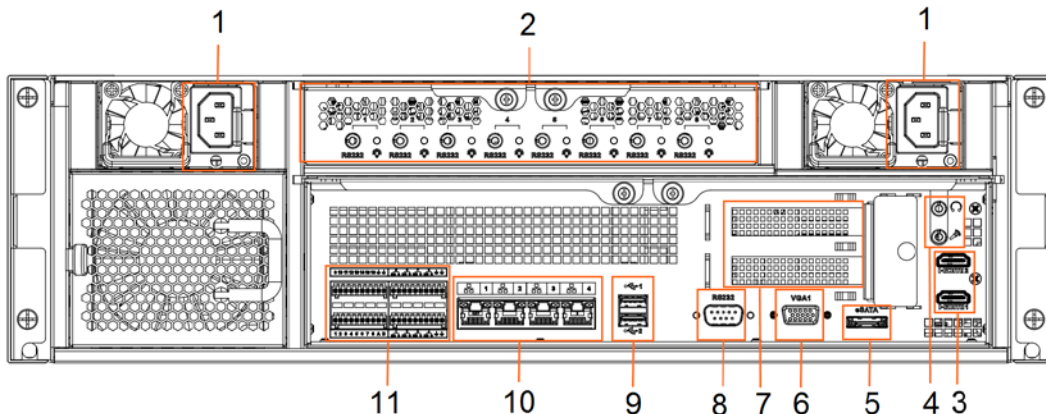



Table 2-7 IVSS7116 rear panel description

No.	Name	Description
1	Power input port	Inputs 100-127 VAC/200-240 VAC power. Some devices only have one power port.
2	AI module indicator light	<p>Displays AI module status.</p> <ul style="list-style-type: none"> • The yellow light flashes: AI module is running properly. • The yellow light is on: AI module is malfunctioning. <p> This function is not available without AI module.</p>

No.	Name	Description
3	HDMI port	High definition audio and video signal output port. The port outputs the uncompressed high definition video and multi-channel audio data to the connected display with HDMI port. The two HDMI ports are different source output.
4	AUDIO IN	Audio input port.
	AUDIO OUT	Audio output port
5	eSATA port	SATA peripheral port. Connects to SATA port or eSATA device.
6	VGA port	VGA video output port. It outputs analog video signal. The VGA port and HDMI 1 port are same source output.
7	PCI-E X4	PCI Express port. It supports X4 slot.
8	RS-232 port	RS-232 COM debug. It is used for general COM debug, setting IP address, and transmitting transparent COM data.
9	USB port	Connects to external devices such as USB storage device, keyboard and mouse.
10	Network port	10/100/1000 Mbps self-adaptive Ethernet port. Connects to the network cable.
11	Alarm Input	<p>16 groups (1–16) alarm input ports. They are corresponding to ALARM 1–ALARM 16. The alarm becomes valid in low level.</p> <ul style="list-style-type: none"> ● A and B: Control the A/B cable of the RS-485 device. It is used to connect to the PTZ camera. Please connect 120Ω between A/B cables if there are too many PTZ decoders. ● \perp: GND end.
	Alarm Output	<p>8 groups of alarm output ports (NO1 C1–NO8 C8). They output alarm signal to the alarm device. Please make sure there is power to the external alarm device.</p> <ul style="list-style-type: none"> ● NO: Alarm output port of Normally Open type. ● C: Common alarm output port. ● \perp: GND end.

2.3.3 Dimensions

Figure 2-21 Dimensions with LCD (mm [inch])

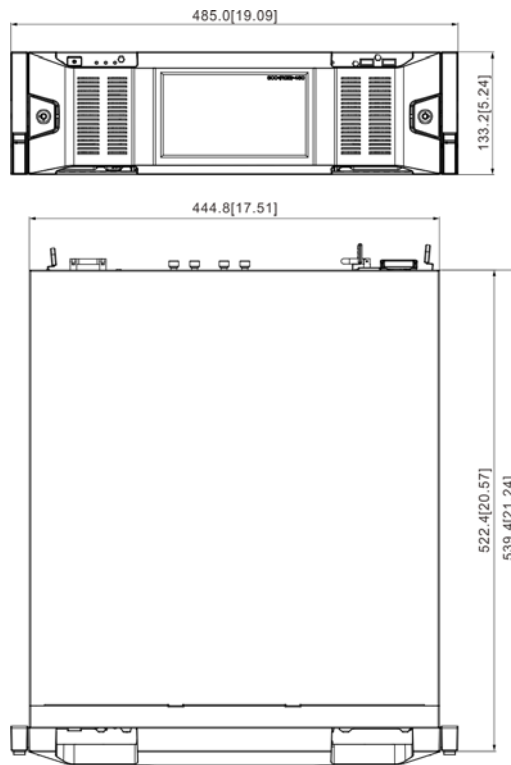
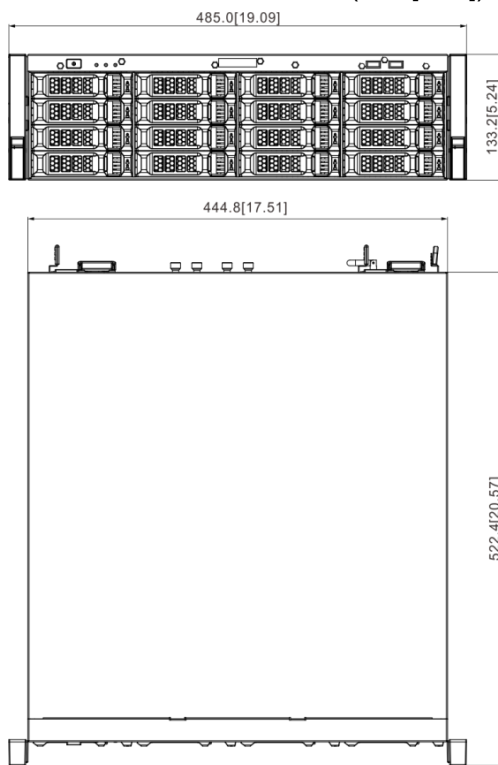

Figure 2-22 Dimensions without LCD (mm [inch])



2.4 24-HDD Series

2.4.1 Front Panel

Figure 2-23 Front panel with LCD

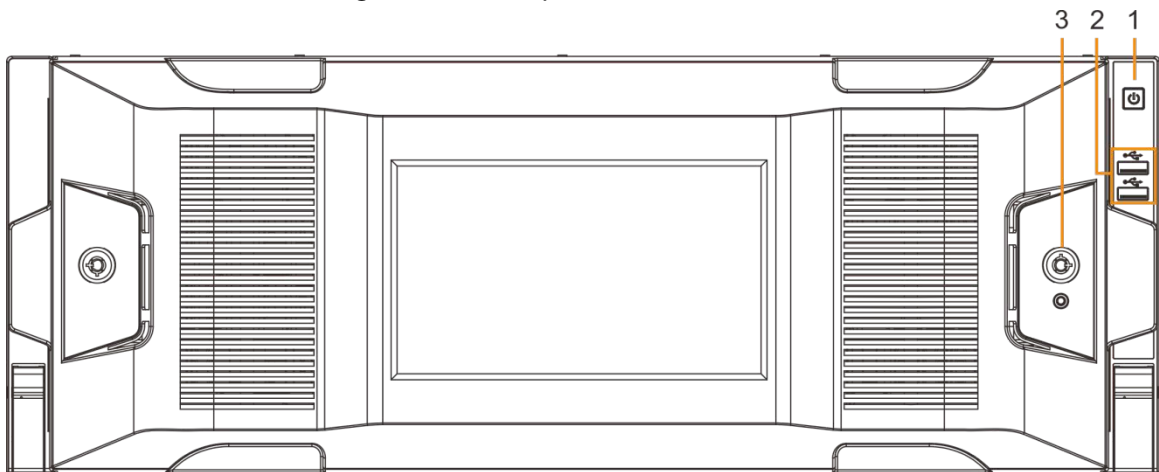

Figure 2-24 Front panel without LCD

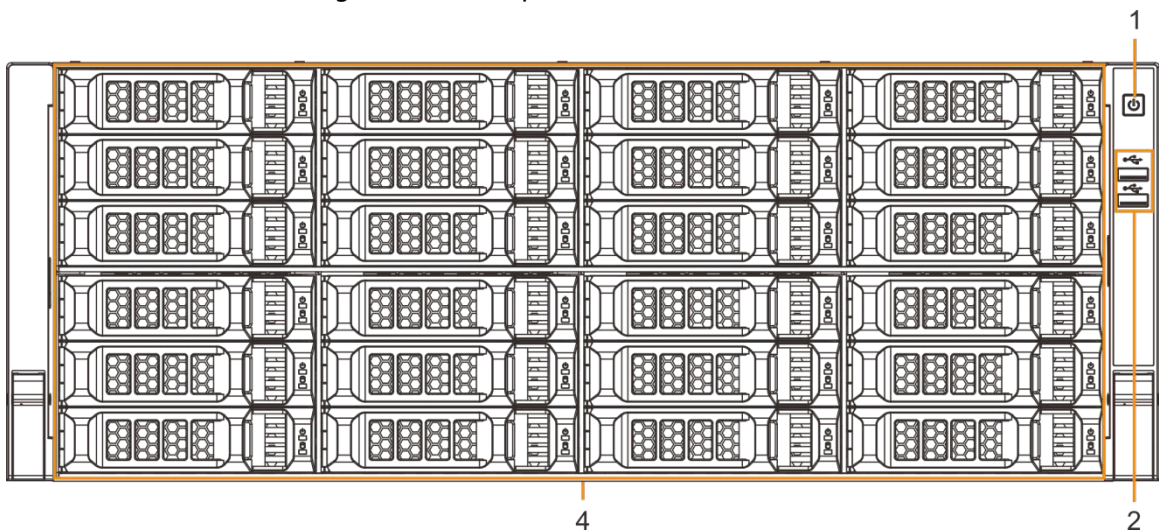

Table 2-8 Front panel description

No.	Button/Port	Description
1	Power on-off button	Boot up or shut down device. The power on-off button has the indicator light. It can display device-running status. <ul style="list-style-type: none"> When device is off (indicator light is off), press the button for a short period to boot up device. When device is running, (blue indicator light is on), press the button for at least 4 seconds to shut down the device.
2	USB port	Connects to external devices such as USB storage device, keyboard and mouse.

No.	Button/Port	Description
3	Front panel lock	Once the front panel lock is secure, it can prevent HDD from being stolen or removed by mistake. Unlock the front panel lock and remove the front panel, you can view 16 HDD slots.
4	24-HDD slot	<p>After you remove the front panel, you can see there are 24 HDDs. From the left to the right and from the top to the bottom, it ranges from 1–4, 5–8, 9–12, 13–16, 17–20, and 21–24.</p> <p>There are two indicator lights on the HDD slot: HDD indicator light and HDD read/write indicator light.</p> <ul style="list-style-type: none"> • : HDD indicator light. The light is yellow after you install the HDD. • : Read/write indicator light. The blue light flashes when it is reading and writing data.

2.4.2 Rear Panel

Figure 2-25 IVSS7024 rear panel (single power)

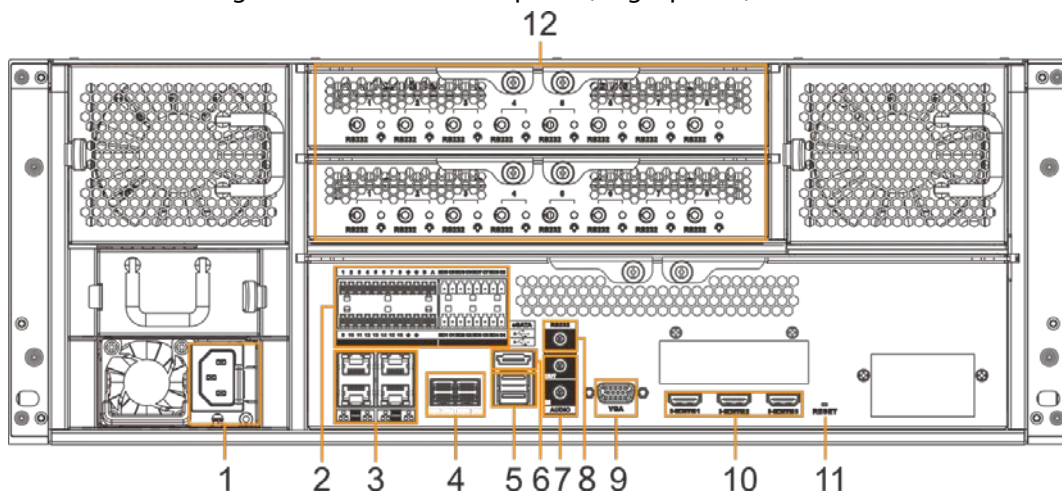

Figure 2-26 IVSS7024 rear panel (redundant power)

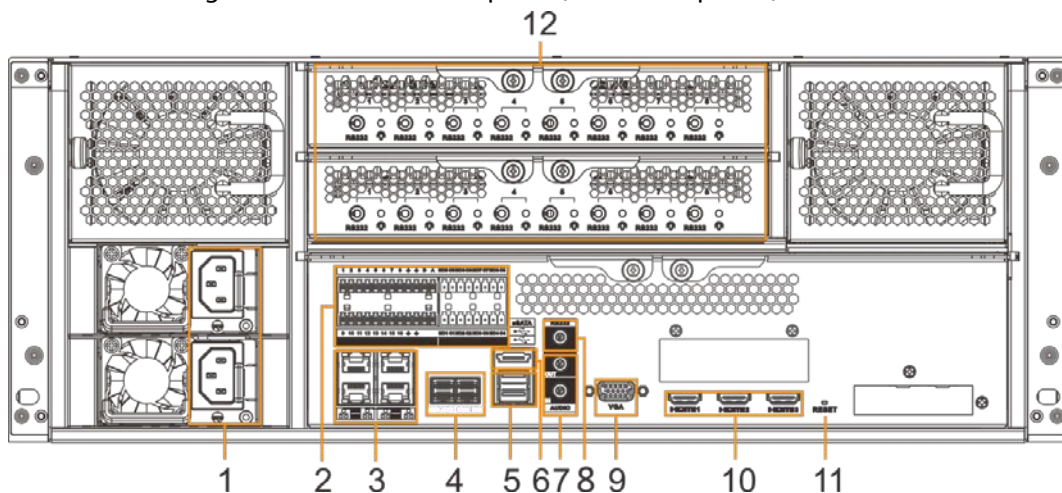

Figure 2-27 IVSS7024-M rear panel (single power)

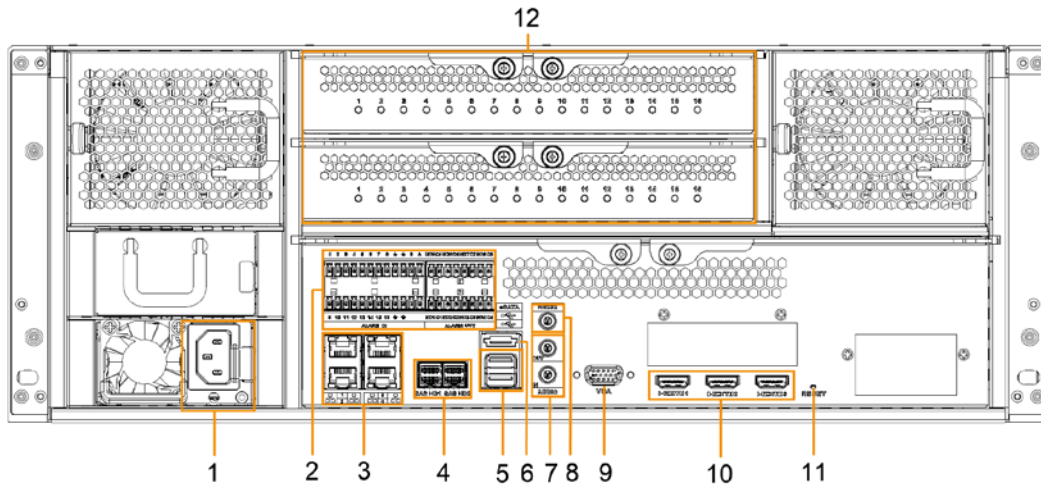

Figure 2-28 IVSS7024-M rear panel (redundant power)

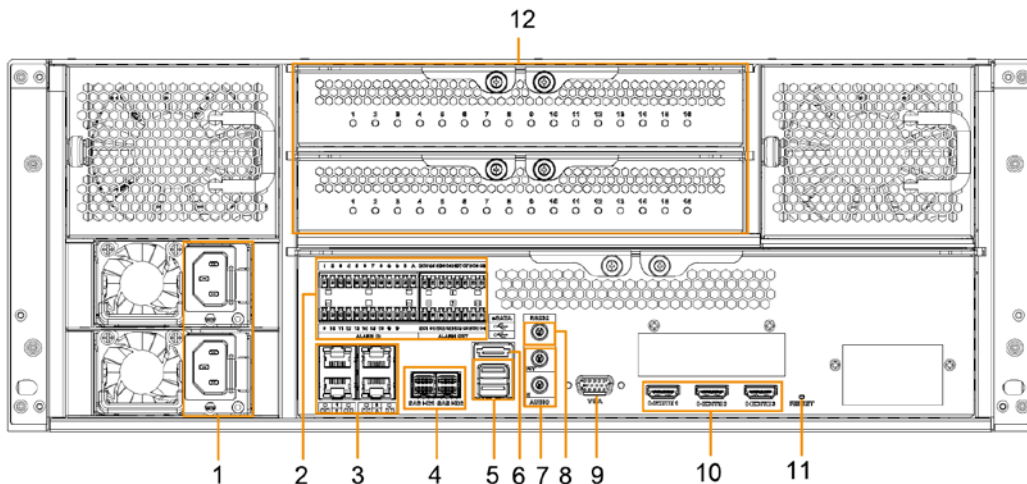

Table 2-9 Rear panel description (1)

No.	Button/Port	Description
1	Power input port	Inputs 100–240 VAC power.
2	Alarm Input	16 groups (1–16) alarm input ports. They are corresponding to ALARM 1–ALARM 16. The alarm becomes valid in low level. <ul style="list-style-type: none"> • A and B: Control the A/B cable of the RS–485 device. It is used to connect to the PTZ camera. Please connect 120 Ω between A/B cables if there are too many PTZ decoders. • \perp: GND end.
	Alarm Output	8 groups of alarm output ports (NO1 C1–NO8 C8). They output alarm signal to the alarm device. Please make sure there is power to the external alarm device. <ul style="list-style-type: none"> • NO: Alarm output port of Normally Open type. • C: Common alarm output port. • \perp: GND end.

No.	Button/Port	Description
3	Network port	10/100/1000Mbps self-adaptive Ethernet port. Connects to the network cable.
4	SAS port	SAS extension port. It can connect to the SAS extension controller.
5	USB port	Connects to external devices such as USB storage device, keyboard and mouse.
6	eSATA port	SATA peripheral port. Connects to SATA port or eSATA device.
7	AUDIO IN	Audio input port.
	AUDIO OUT	Audio output port
8	RS-232 port	RS-232 COM debug. It is used for general COM debug, setting IP address, and transmitting transparent COM data.
9	VGA port	VGA video output port. It outputs analog video signal. The VGA port and HDMI 1 port are same source output.
10	HDMI port	High definition audio and video signal output port. The port outputs the uncompressed high definition video and multi-channel audio data to the connected display with HDMI port. The three HDMI ports are different source output.
11	RESET button	Reserved.
12	AI module indicator light	Displays AI module status. <ul style="list-style-type: none"> The yellow light flashes: AI module is running properly. The yellow light is on: AI module is malfunctioning.  This function is not available without AI module.

Figure 2-29 IVSS7124 rear panel (single power)

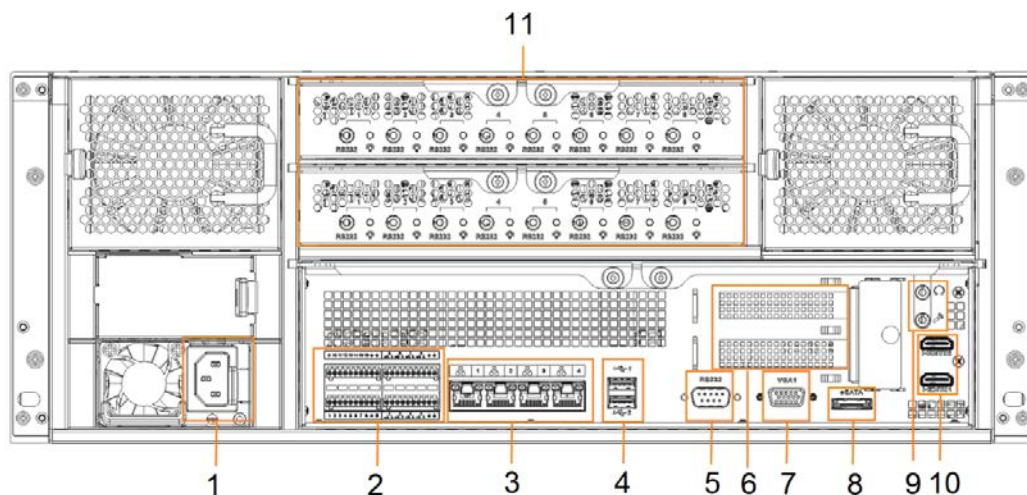

Figure 2-30 IVSS7124-M rear panel (redundant power)

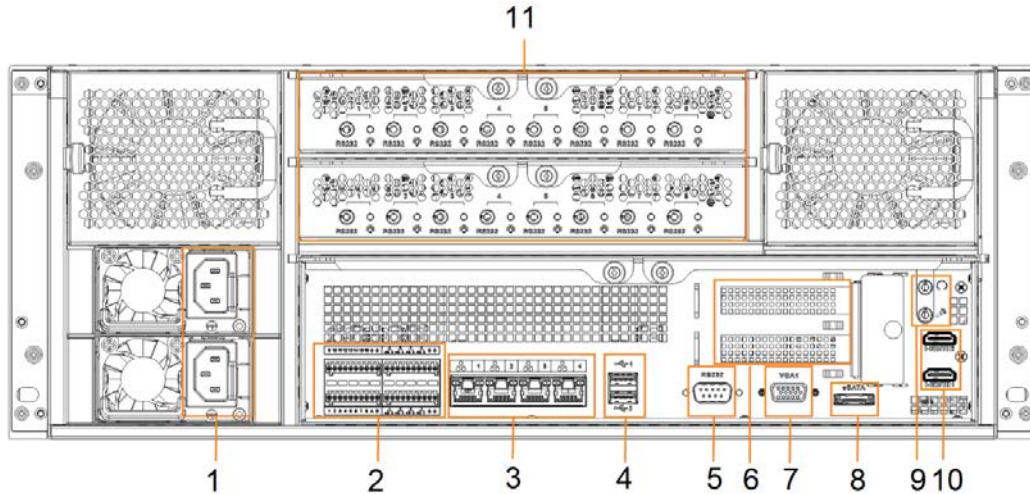



Table 2-10 Rear panel description (2)

No.	Name	Description
1	Power input port	Inputs 100V-127V/200-240V AC power.
2	Alarm Input	16 groups (1–16) alarm input ports. They are corresponding to ALARM 1–ALARM 16. The alarm becomes valid in low level. <ul style="list-style-type: none"> ● A and B: Control the A/B cable of the RS–485 device. It is used to connect to the PTZ camera. Please connect 120Ω between A/B cables if there are too many PTZ decoders. ● \perp: GND end.
	Alarm Output	8 groups of alarm output ports (NO1 C1–NO8 C8). They output alarm signal to the alarm device. Please make sure there is power to the external alarm device. <ul style="list-style-type: none"> ● NO: Alarm output port of Normally Open type. ● C: Common alarm output port. ● \perp: GND end.
3	Network port	10/100/1000Mbps self-adaptive Ethernet port. Connects to the network cable.
4	USB port	Connects to external devices such as USB storage device, keyboard and mouse.
5	RS-232 port	RS-232 COM debug. It is used for general COM debug, setting IP address, and transmitting transparent COM data.
6	PCI-E X4	PCI Express port. It supports X4 slot.
7	VGA port	VGA video output port. It outputs analog video signal. The VGA port and HDMI 1 port are same source output.
8	eSATA port	SATA peripheral port. Connects to SATA port or eSATA device.
9	AUDIO IN	Audio input port.

No.	Name	Description
	AUDIO OUT	Audio output port
10	HDMI port	High definition audio and video signal output port. The port outputs the uncompressed high definition video and multi-channel audio data to the connected display with HDMI port. The two HDMI ports are different source output.
11	AI module indicator light	Displays AI module status. <ul style="list-style-type: none"> • The yellow light flashes: AI module is running properly. • The yellow light is on: AI module is malfunctioning.  This function is not available without AI module.

2.4.3 Dimensions

Figure 2-31 Dimensions with LCD (mm [inch])

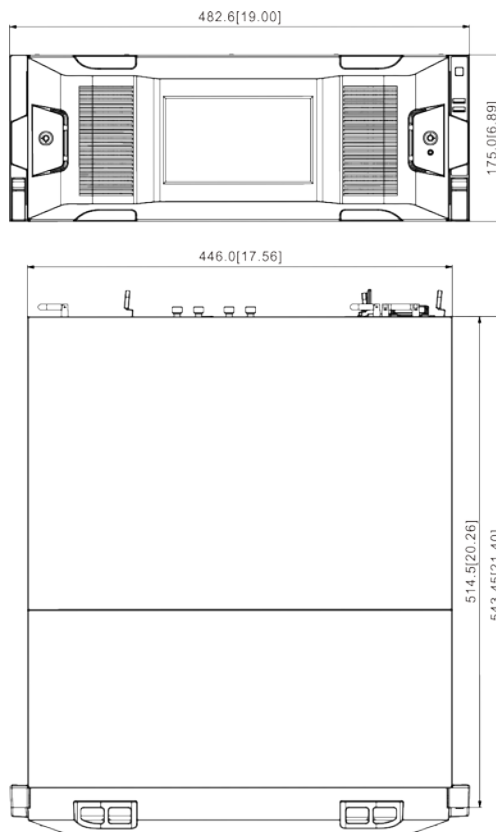

Figure 2-32 Dimensions without LCD (mm [inch])



3 Hardware Installation

This section introduces HDD installation, cable connection, and so on.



Some series product is heavy. It needs several persons to carry or move, in order to prevent person injury.

3.1 Installation Flow

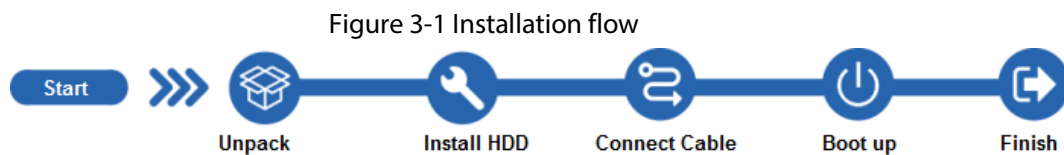

3.2 Unpacking the Box

When you receive the Device, please check against the following checking list. If any of the items are missing or damaged, contact the local retailer or after-sales engineer immediately.

Table 3-1 Checking list

No.	Item	Content	
1	Whole package	Appearance	Check whether there is any visible damage.
		Package	Check whether there is any accidental clash during transportation.
		Accessories (list of accessories on the warranty card)	Check whether they are complete.
2	Device	Appearance	Check whether there is any visible damage.
		Device model	Check whether the model is the same as order contract.
		The label on the device	Check whether it is torn or not. Do not tear off, or discard the label. Usually you need to show the serial number when we provide after-sales service.

3.3 HDD Installation

The section introduces the detailed operations to install HDD.



Different models support different HDD numbers.

3.3.1 8-HDD Series

Step 1 Remove the 2 screws on the rear panel.

Figure 3-2 Remove screws

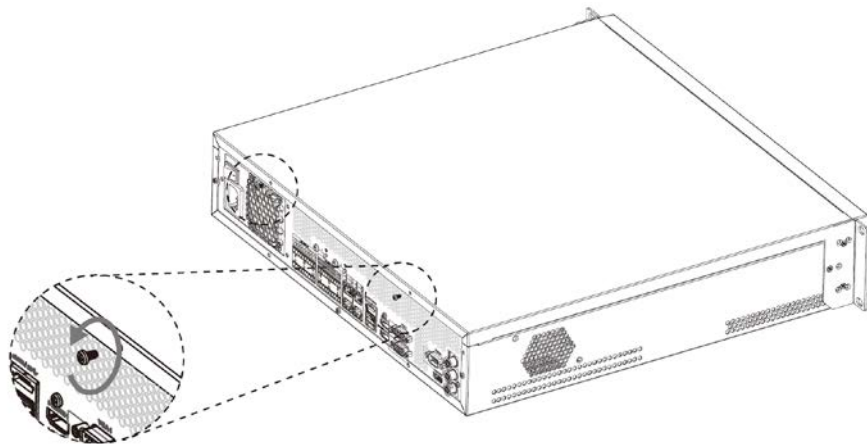

Step 2 Remove the chassis cover in the direction indicated by the arrow.

Figure 3-3 Remove chassis cover

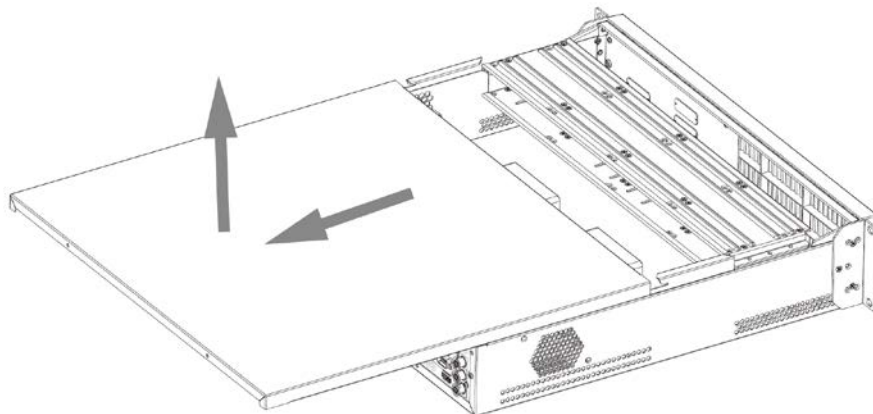

Step 3 Remove the screws on the edge of the HDD holder, and then remove the holder.

Figure 3-4 Remove HDD holder

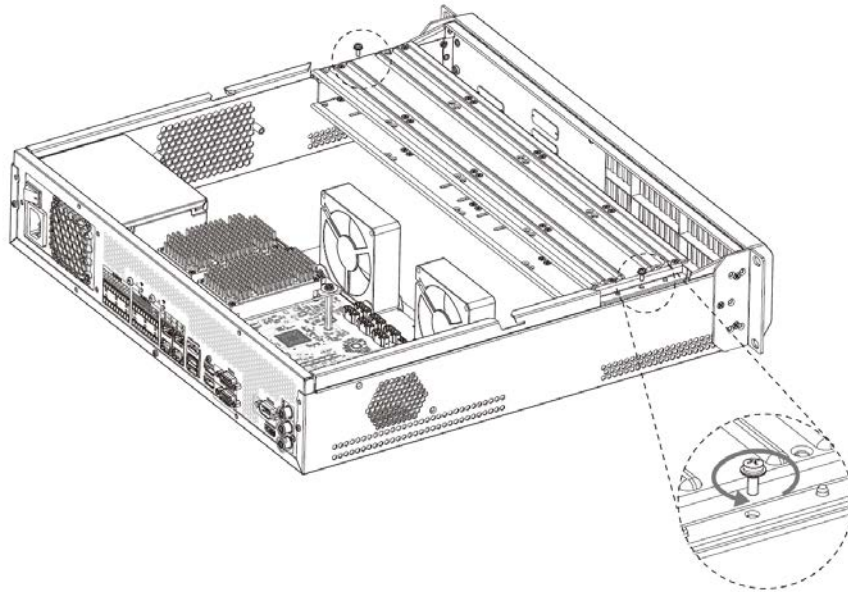

Step 4 Align the 4 screw holes on the HDD to the 4 screw holes on the HDD holder, and then tighten the screws.

Figure 3-5 Install HDD (1)

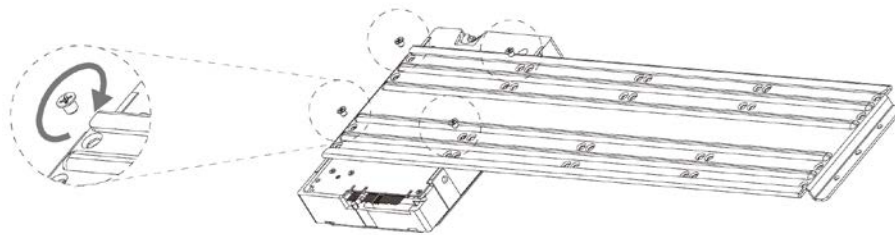

Step 5 Repeat step 4 to install the other HDDs on the holder.

Figure 3-6 Install HDD (2)

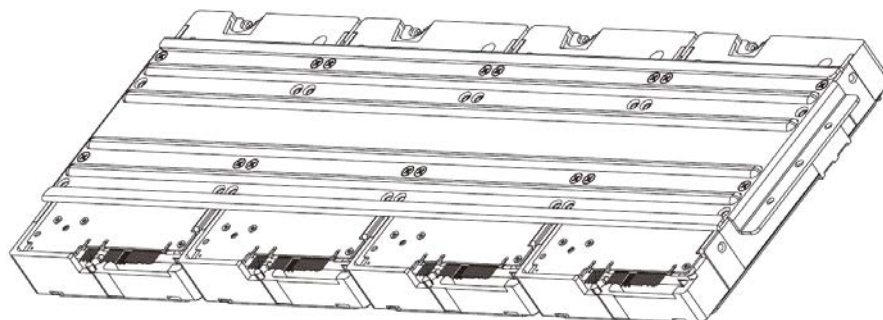

Step 6 Repeat step 5 to install HDDs on the other holder.

Figure 3-7 Install HDD (3)

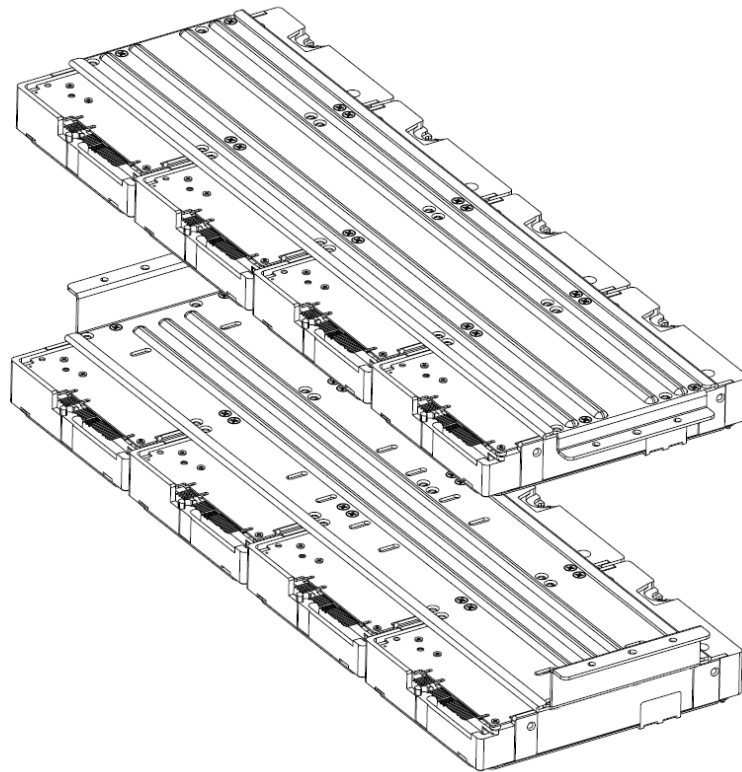

Step 7 Align the left and right 2 pairs of holes of the two holders to the corresponding holes on the chassis, place the holders on the chassis, and then tighten the screws on the edge of the holders.

Figure 3-8 Install HDD holders

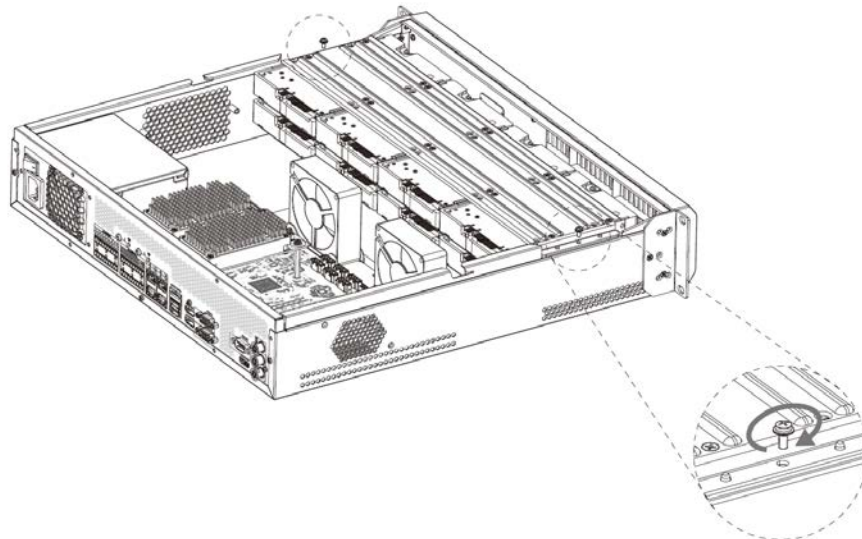

Step 8 Connect HDD signal wire and power cord.

Step 9 Put back the cover, and then tighten the 2 screws on the rear panel.

3.3.2 12-HDD Series



If you have not pushed the HDD box to the bottom, do not close the handle to avoid any damage to

the HDD slot.

Installing HDD

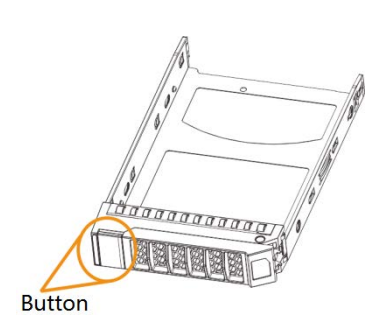
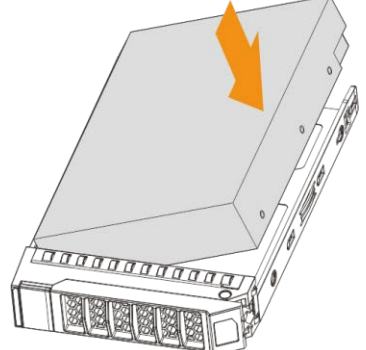
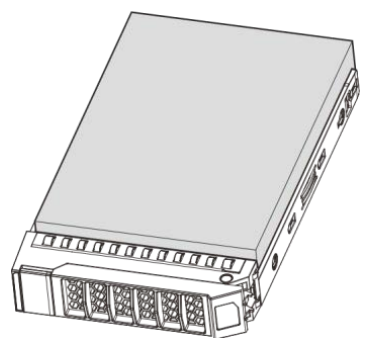
 <p>Button</p>		
<p>① Press the button on the front panel of IVSS, open the handle, and then pull out the HDD box.</p>	<p>② Place one side of the HDD closely along the upper side of the box and press down to push the HDD down to the lower side of the mounting surface.</p>	<p>③ Insert the HDD box into the HDD slot, press it to the bottom, and then close the box handle.</p>

Removing HDD

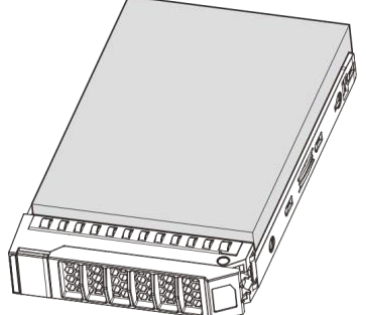
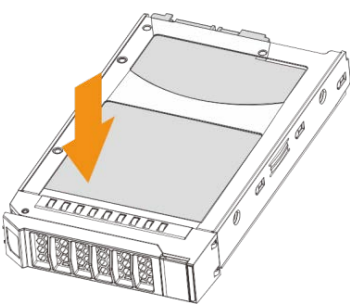
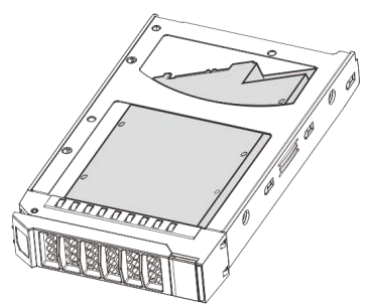

		
<p>① Press the button on the front panel of IVSS, open the handle, and then pull out the HDD box.</p>	<p>② On the back of the HDD box, press hard on the position indicated by the arrow.</p>	<p>③ Take out the HDD and reinsert the box to the slot. Push it to the bottom and close the box handle.</p>

3.3.3 16/24-HDD Series



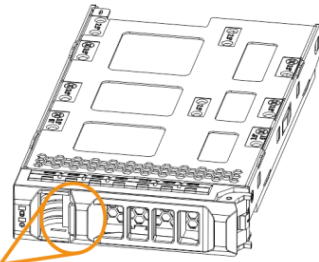
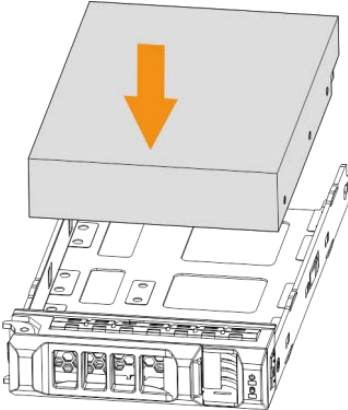
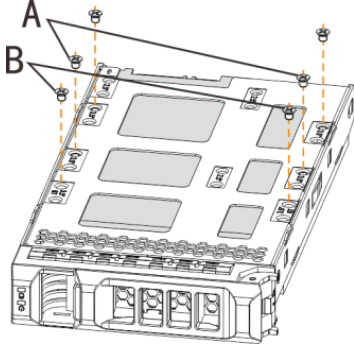

If you have not pushed the HDD box to the bottom, do not close the handle to avoid any damage to the HDD slot.

Installing HDD

 <p>Button</p>		
<p>① Press the button on the front panel of IVSS, open the handle, and then pull out the HDD box.</p>	<p>② Put the HDD into the box along the direction shown in the figure.</p>	<p>③ Lock the screws on the back of the HDD box. Insert the box into the HDD slot, push it to the bottom, and then close the handle.</p> <p> In the figure, you only need to lock one set of the screws (Group A or Group B). See the actual situation.</p>

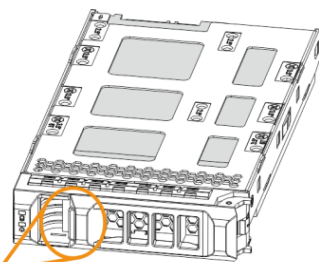
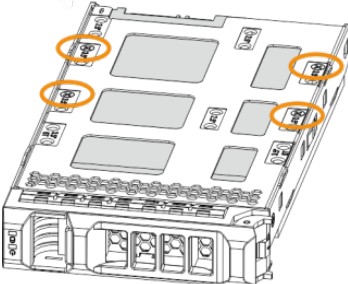
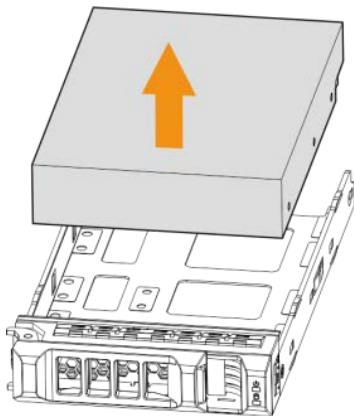
Removing HDD

 <p>Button</p>		
<p>① Press the button on the front panel of IVSS, open the handle, and then pull out the HDD box.</p>	<p>② Unlock the screws on the back of the HDD box.</p> <p> The screws are at different positions for different HDDs.</p>	<p>③ Take out the HDD and reinsert the box to the slot. Push it to the bottom and close the box handle.</p>

3.4 Cable Connection

The section introduces cable connection of the Device.

3.4.1 Alarm Connection

Before using the alarm, connect alarm input or alarm output device.

3.4.1.1 Connection

The section introduces alarm connection of the Device.

Alarm Input

- Both NO and NC are supported.
- The alarm input port supports alarm signal from ground and device of 12-24 V voltage.
- If the alarm device is connected to the Device and other devices, use relay for isolation.

Alarm Output

The alarm output port cannot be connected to high-power load (less than 1A). When forming output circuit, the excessive current should be prevented from causing damage to the relay. Use the contactor for isolation when applying high-power loads.

PTZ Decoder Connection

- The common-ground must be prepared for PTZ decoder and the Device; otherwise the common-mode voltage might not be able to control the PTZ. It is recommended to use shielded twisted pair, and the shielding layer can be used for common ground.
- Prevent interference from high-voltage power, make reasonable wiring, and take measures for lightning protection.
- Remotely import 120 Ω to reduce resistance reflection and protect the signal quality.
- The Device A line and B line cannot connect to other RS-485 output device in parallel.
- The voltage between the A line and B line of PTZ decoder must be less than 5 V.

Notes to Grounding

- Poor grounding of camera might damage the chip.
- When supplying external power source to the alarm device, the alarm device should be common-grounded with the Device.

3.4.1.2 Alarm Port

Figure 3-9 8-HDD series

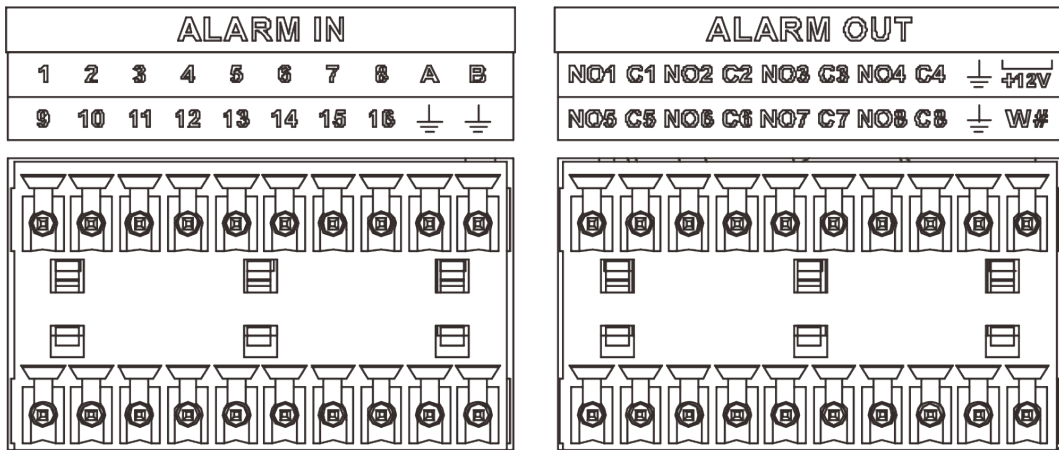

Figure 3-10 12-HDD series

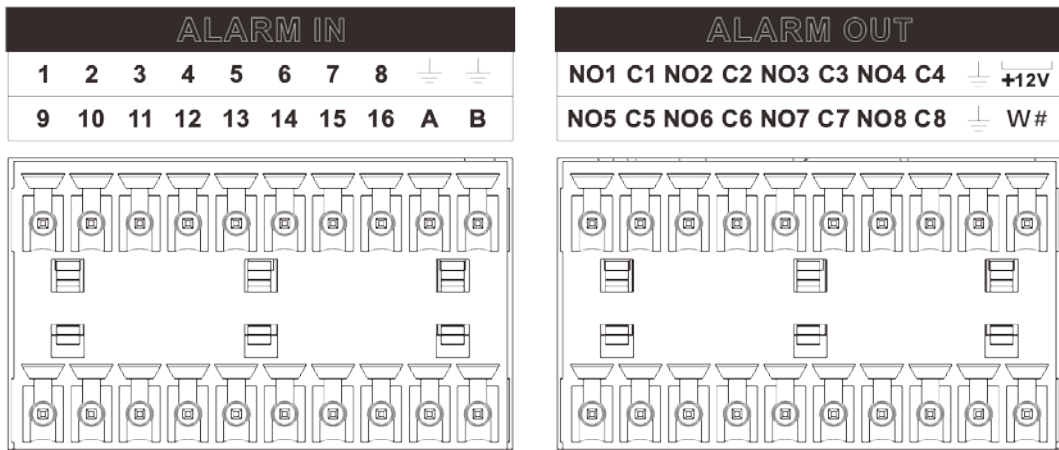

Figure 3-11 16/24-HDD series (1)

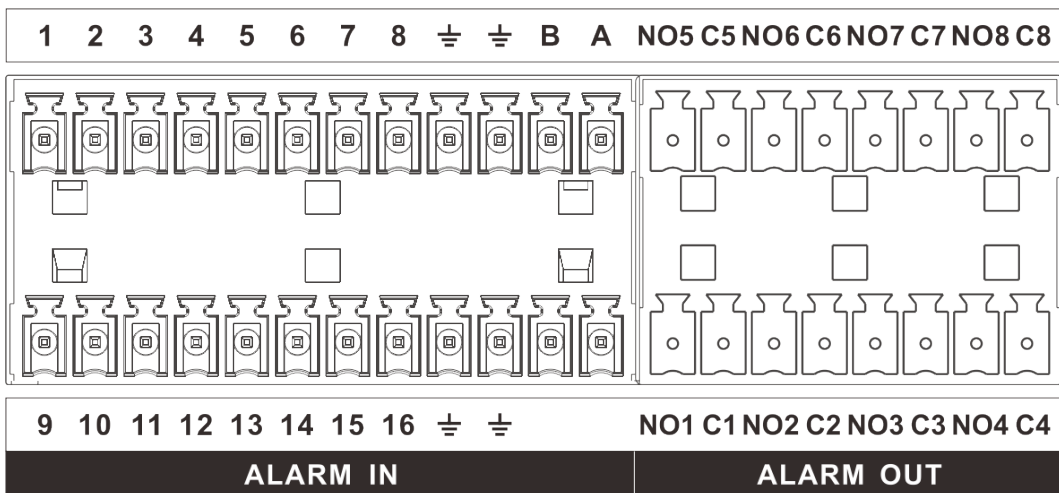

Figure 3-12 16/24-HDD series (2)

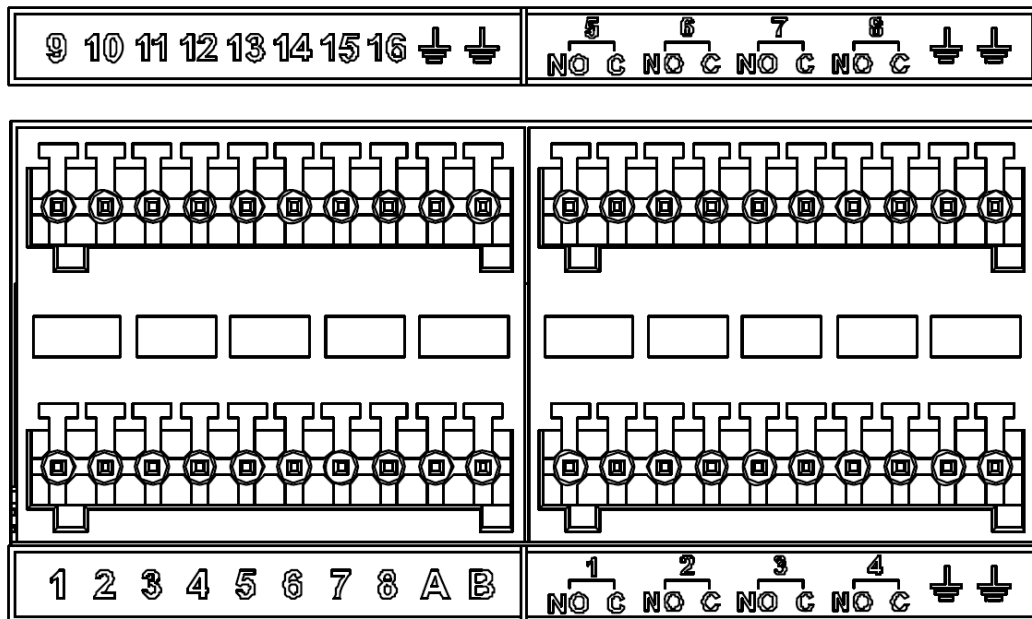

Table 3-2 Alarm port

Icon	Description
1-16	They are corresponding to ALARM 1-ALARM 16. The alarm becomes valid in low level.
NO1 C1-NO8 C8	Eight groups of normally open linkage output (on-off value).
+12V	Constant power output, 500mA current.
⏏	Grounding wire.
A, B	A and B: Control the A/B cable of the RS-485 device. It is used to connect to the PTZ camera. Please parallel connect 120Ω between A/B cables if there are too many PTZ decoders.

3.4.1.3 Alarm Input

Both NO and NC are supported. For connection of NC alarm input port, see the following figures.

- GND and COM of alarm device shall be connected in parallel. Alarm device shall be powered with external power source.
- Connect GND of alarm device with GND of Device in parallel.
- Connect the NC port of alarm device to the alarm input port (1-16).

Figure 3-13 NC alarm input connection

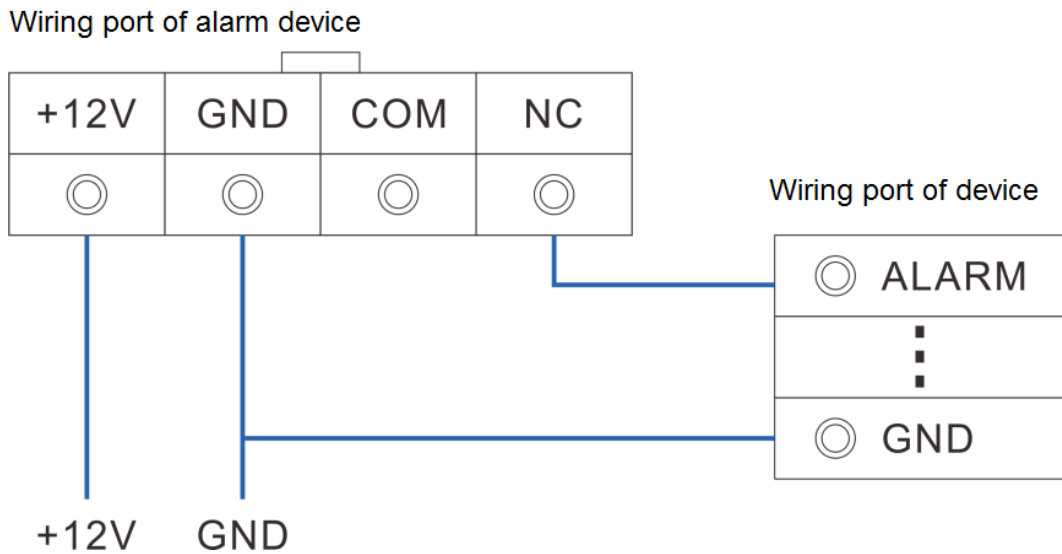

3.4.1.4 Alarm Output

- The alarm output is on-off output (Normally Open Contact), and there should be external power supply to alarm output device.
- RS-485 A line and B line: connecting the A line and B line on the PTZ decoder.
- To avoid overload from damaging the Device, see the parameters about relay.

Table 3-3 Relay parameters of alarm output port

Model		HRB1-S-DC5V
Contact material		Silver
Rated value (resistance load)	Rated power capacity	24 VDC 2A, 125 VAC 2A
	Maximum power	62.5 VA/30 W
	Maximum power voltage	125 VAC, 60 VDC
	Maximum power current	2 A
Insulation	Between contacts	1000 VAC 1 minute
	Between contact and loop	400 VAC 1 minute
Insulation voltage		1,000 MΩ (500 VDC)
Turn-on Time		< 5 ms
Turn-off Time		< 5 ms
Life	Mechanical	300 times per minute
	Electrical	30 times per minute

Model	HRB1-S-DC5V
Operating ambient temperature	-30 °C to +70 °C

3.4.2 Connection Diagram



The following steps are to connect 16-HDD series device. See the actual product for detailed information.

The following figure is for reference only. The actual product shall prevail.

- Display, mouse and keyboard are needed for local operation.
- Before using the smart detection functions such as face detection and face recognition, you shall install the AI module first.

Figure 3-14 Connection diagram

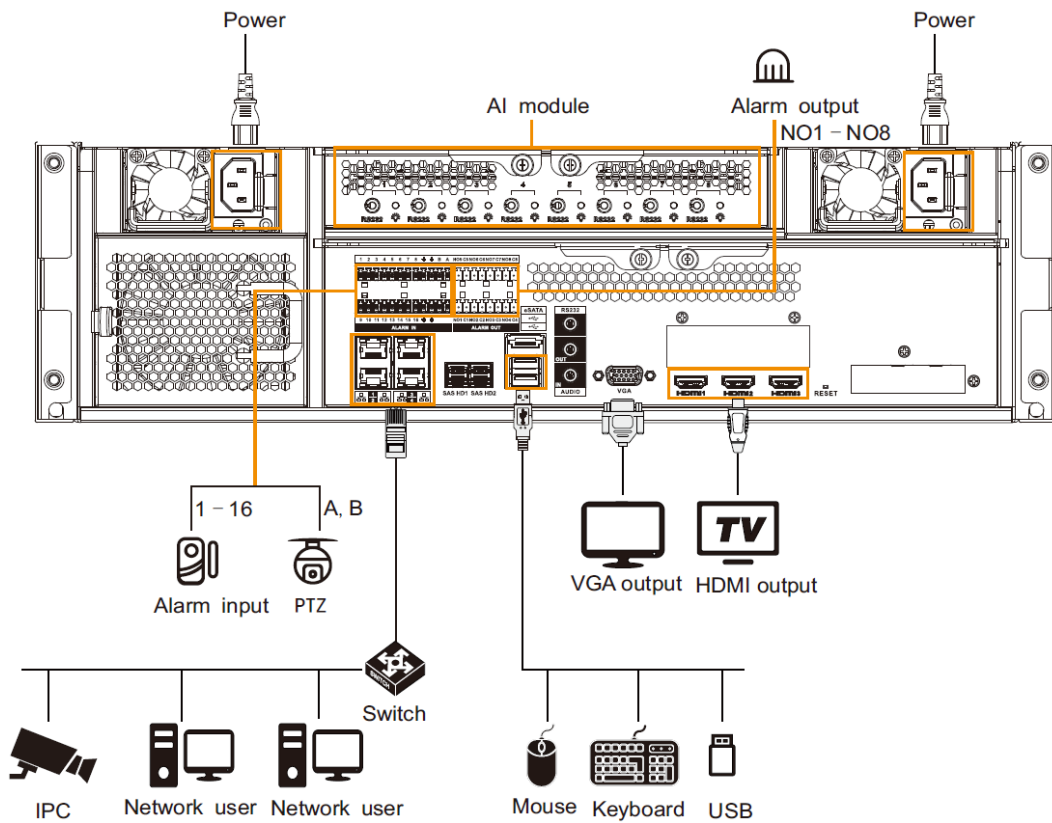

4 Starting the Device



- Before starting the device, make sure that the input voltage shall match the device power requirement.
- To ensure stable operation of the device and prolong service life of HDD, provide stable voltage with less ripple interference by reference to international standard.
- For device security, connect other cables of the device first, and then connect the device to the power socket.

Boot-up might be different depending on the model you purchased.

- 8-HDD series: Press the power button on the rear panel to start the Device.
- For other series:
 - ◇ Connect to the power socket to start the Device.
 - ◇ After clicking shutdown button on the GUI to shut down the Device, press the power button for a short period of time to start the Device.

5 Initial Settings

When using the Device for the first time, initialize the device, and set basic information and functions first.

5.1 Initializing Device

If it is your first time to use the device after purchasing or after restoring factory defaults, set a login password of admin (system default user). At the same time, you can set proper password protection method.



Take web remote initialization for example.

Step 1 Open the browser, enter IP address, and then press Enter.



Default IP address of network port 1 to network port 4 are 192.168.1.108 to 192.168.4.108.

Enter the corresponding IP address of the actually connected network port.

Step 2 On the **Language Set** page, select a country or region, a language, and a language standard. Click **Next**. The language setting step is only available on the local interface of the Device.

Figure 5-1 Time setting

Device Initialization

1 Time 2 Input Password 3 Password Protection

Date
2019-11-04

Time
10:52:52

Time Zone

Time

Manual Setting

Date/Time 2019 - 11 - 04 10 : 51 : 35

Sync with Internet Time Server

Server clock.isc.org

Auto Sync Time Interval 1 hours

Next

Step 3 On the **Time** page, set time parameters.

Table 5-1 Time parameters description

Parameters	Description
Time Zone	The time zone of the Device.
Time	<p>Set system date and time manually or by synchronizing with NTP server time.</p> <ul style="list-style-type: none"> • Manual Setting: Select date and time from the calendar. • Sync with Internet Time Server: Select Sync with Internet Time Server, enter NTP server IP address or domain, and then set the automatic synchronization interval. <p> Device time will synchronize with the server time after Sync with Internet Time Server is set.</p>

Step 4 Click **Next**.

Figure 5-2 Set password

The screenshot shows the 'Device Initialization' process at the 'Input Password' step. The progress bar at the top indicates three steps: 'Time' (completed), 'Input Password' (current), and 'Password Protection' (pending). The main area contains three input fields: a Username field with a person icon, a Password field with a lock icon and a strength indicator, and a Confirm Password field with a lock icon. At the bottom right, there are 'Back' and 'Next' buttons.

Step 5 Set admin login password.

Table 5-2 Description of password parameters

Parameters	Description
Username	The default username is admin.
Password	Set admin login password, and confirm the password.
Confirm Password	The new password can be 8 characters to 32 characters in length and contains at least two types from number, letter and special characters (excluding " ";& and space). Enter a strong password according to the password strength indication.

Step 6 Click **Next**.

Figure 5-3 Password protection

Step 7 Set password protection information.

You can use the email you input here or answer the security questions to reset admin password. See "8.7.3.2 Resetting Password" for detailed information.



- Click to cancel the email or security questions.
- If the email is not set, the password can be reset on the local interface only.

Table 5-3 Password protection

Password protection mode	Description
Email	Leave an email address for resetting password.
Security question	Set security questions and corresponding answers. Reset the password through the security question.

Step 8 Click **Finish** to complete device initialization.

5.2 Quick Settings

After initializing the device, the system goes to quick settings page. You can quickly set system time, IP address, and P2P.

5.2.1 Configuring IP Address

Configure device IP address, DNS server information and other information according to network planning.



Device has 4 Ethernet ports by default. Make sure that at least one Ethernet port has been connected to the network before you set IP address.

Step 1 On the completion page of initialization, click **Enter Quick Setting**.

Figure 5-4 IP setting

NIC	NIC Type	Dhcp	IP Address	Subnet Mask	Mac	Speed	Operate
Ethernet Netw...	Electric Port	No	[IP Address]	[Subnet Mask]	[Mac]	10M/100M/1000...	[Edit]
Ethernet Netw...	Electric Port	No	[IP Address]	[Subnet Mask]	[Mac]	10M/100M/1000...	[Edit]
Ethernet Netw...	Electric Port	No	[IP Address]	[Subnet Mask]	[Mac]	10M/100M/1000...	[Edit]
Ethernet Netw...	Electric Port	No	[IP Address]	[Subnet Mask]	[Mac]	10M/100M/1000...	[Edit]

DNS Server

IP Type:

Obtain DNS server address automatically

Use the following DNS server address

Preferred DNS:

Alternate DNS:

Default NIC

Default Ethernet:

Step 2 Configure IP address.

1) Click of the corresponding NIC.

Figure 5-5 Edit Ethernet network

Speed: 1000 Mb/s

IP Type:

Use Dynamic IP Address

Use Static IP Address

Static IP Address:

Subnet Mask:

Gateway:

MTU: (1500-7200)

2) Set parameters.

Table 5-4 TCP/IP parameters description

Parameters	Description
Speed	Current NIC max network transmission speed.
IP Type	Select IPv4 or IPv6.

Parameters	Description
Use dynamic IP address	When there is a DHCP server on the network, check Use Dynamic IP Address , system can allocate a dynamic IP address to the device. There is no need to set IP address manually.
Use static IP address	Check Use Static IP Address , and then set static IP address, subnet mask and gateway to set a static IP address for the device.
MTU	<p>Set NIC MTU value. The default setup is 1500 Byte.</p> <p>We recommend you to check the MTU value of the gateway first and then set the device MTU value equal to or smaller than the gateway value. It is to reduce the packets slightly and enhance network transmission efficiency.</p> <p> Please be advised that changing MTU value might result in NIC reboot, network offline and affect current running operation.</p>

3) Click **OK**.

Device goes back to **IP Set** page.

Step 3 Set DNS server information.

You can select to get DNS server manually or input DNS server information.



This step is compulsive if you want to use domain service.

1) Select an IP type for DNS server. You can select IPv4 or IPv6.

2) Select the way of setting DNS IP address.

Step 4 Set default NIC.

Select default NIC from the drop-down list.



Make sure that the default NIC is online.

Step 5 Click **Next** to save settings.

5.2.2 Configuring P2P Settings

P2P is a peer to peer technology. You can scan the QR code to download cellphone APP without DDNS service or the port mapping or installing the transmission server. After register the device to the APP, you can view the remote video, playback record file and so on.



Make sure that the system has been connected to the network. Otherwise, the P2P function is null.

Step 1 On **IP Set** page, click **Next**, and then scan the QR code on the actual page.

Figure 5-6 P2P access

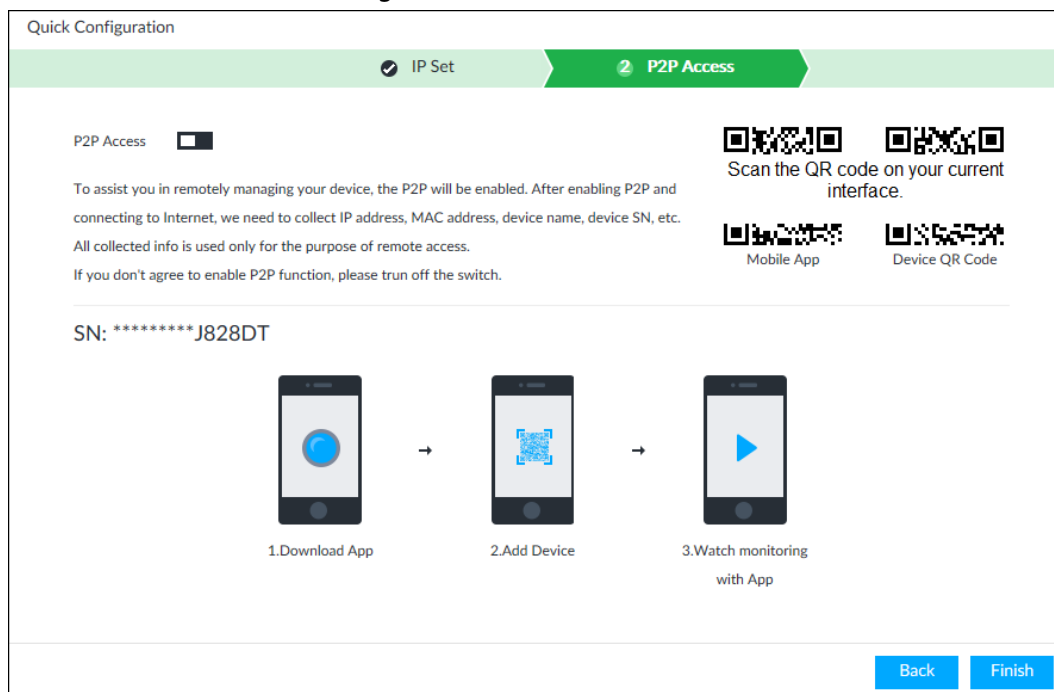

Step 2 Click to enable P2P function. The function is disabled by default.

Step 3 Click **Finish** to save settings.

After the configuration, you can register a device to the APP to view remote video, playback record file, and so on. See corresponding cellphone APP for detailed information.

5.3 Login

You can operate the device by using the local interface, web client and PCAPP.

- Monitor and mouse are needed for local operation.
- Remotely access with web and IPCAPP. PCAPP client is recommended.



After initializing the device, you have logged in by default. Now you can set system settings and operate.

5.3.1 Logging in to PCAPP Client

Log in to PCAPP for system configuration and operation.

Step 1 Download PCAPP.

- 1) Open the browser, enter IP address, and press Enter.
- 2) Click **Download PCAPP** to download PCAPP installation package.

Step 2 Install PCAPP.

- 1) Double-click the installation package.
- 2) Select a language of PCAPP.
- 3) Click **EULA**, read through the content, and then select the checkbox of **I Agree EULA**.
- 4) (Optional) Select installation path, click **Custom**, and then select a path.
- 5) Click **Install**.

Step 3 Log in to PCAPP.

1) There are two ways to enter PCAPP.

- On the installation completion page, click **Run**.
- Double-click the shortcut icon  on the PC desktop.



- When PC theme is not Aero, the system will remind you to switch the theme. To ensure video smoothness, switch your PC to Aero theme. For details, see "10.4 Configuring PCAPP".
- System displays PCAPP at full-screen by default. Click  to display the task column.

Figure 5-7 Prompt

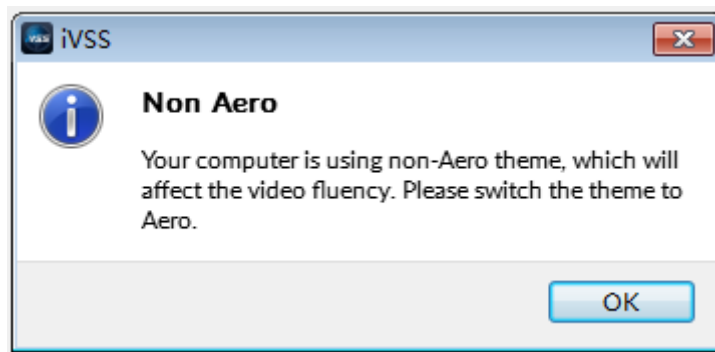



Figure 5-8 Task column



- 2) Enter device IP address, and then press **Enter** or click .
- 3) Enter device username and password.



- Click **Login**. For your device safety, change the admin password regularly and keep it well.
 - In case you forgot password, click **Forgot password** to reset.
- 4) Select the login type among **TCP**, **UDP** and **Multicast**. Keep it as **TCP** if you have no special requirement for TCP or UDP.
 - 5) Click **Login**.

Figure 5-9 Live view

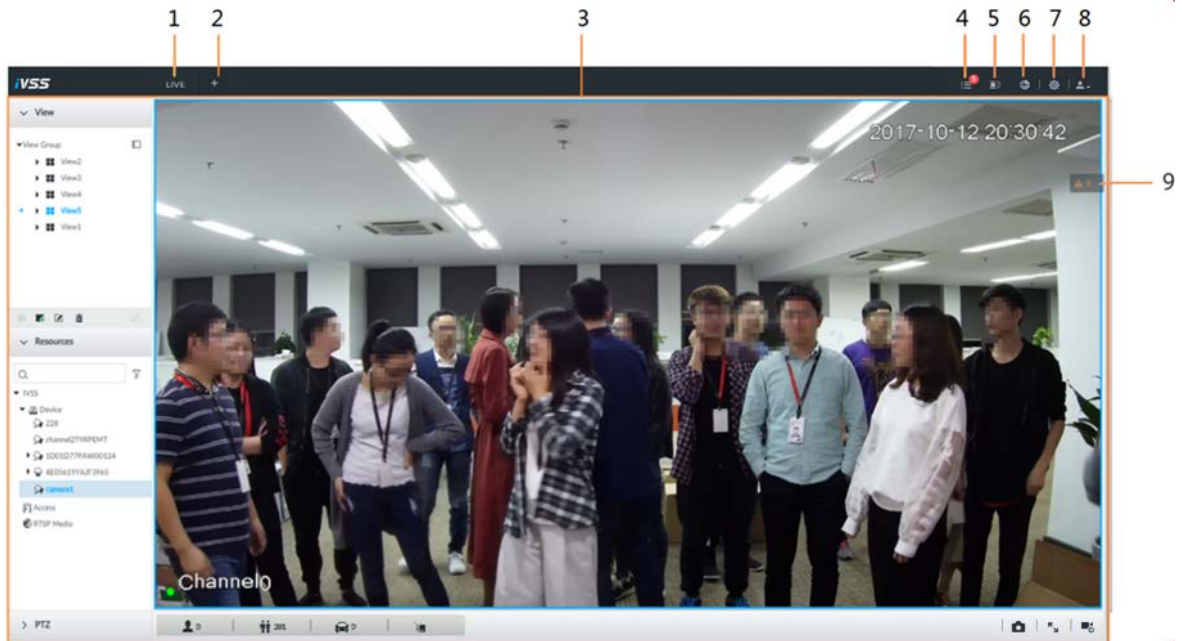





Table 5-5 Home page description

No.	Name	Description
1	Task column	Displays enabled application icon. Point to the app and then click  to close the app.  The live function is enabled by default and cannot be closed.
2	Add icon	Click to display or hide the APPLICATIONS window. On the APPLICATIONS window to view or enable app.
3	Operation page	Displays currently enabled app operation page.
4	System Info	Click to view system information.
5	Buzzer	Click the icon to view buzzer messages.
6	Background Task	Click to view the background running task information.
7	System config	Click to enter system configuration mode.
8	Login user	Click it to change user password, lock user, logout user, reboot device or close device.
9	Alarm list	Click to view the unprocessed alarm event quantity.  Drag this icon to move its position.

5.3.2 Logging in to Local Interface

You can view the local interface of the Device by connecting a display to it, and then you can carry out local operation on the display.

5.3.2.1 Preparation

Ensure that the Device is connected with display, mouse and keyboard. For cable connection, see "3.4 Cable Connection".

5.3.2.2 Operation Steps

Step 1 Turn on the Device.

Step 2 Enter username and password.



- Click **Login**. For your device safety, change the admin password regularly and keep it well.
- Point to  to view the password prompt information. It is to help you remember password.
- In case you forgot password, click **Forgot Password** to reset. See "8.7.3.2 Resetting Password".

Step 3 Click **Login**.



Click  to control the local screen. See "7.7.1 Multiple-screen Control" for detailed information.

5.3.3 Logging in to Web Interface

System supports general browser such as Google Chrome, Firefox to access the web to manage the device remotely, operate and maintain the system.



When you are using general browser to access the web, system supports setting function only. It cannot display the view. It is suggested that PCAPP should be used.

Step 1 Open the browser, input IP address, and press Enter.

Step 2 Enter username and password.



- Click **Login**. For your device safety, change the admin password regularly and keep it well.
- In case you forgot password, click **Forgot Password** to reset. See "8.7.3.2 Resetting Password" for detailed information.

Step 3 Select the login type among **TCP**, **UDP** and **Multicast**. Keep it as **TCP** if you have no special requirement for TCP or UDP.



Step 4 Click **Login**.
System displays **LIVE** page.

5.4 Configuring Remote Device

Register remote device to the system. You can view the live video from the remote device, change remote device settings, and so on.

5.4.1 Initializing Remote Device

After you initialize the remote device, you can change remote device login password and IP address. Remote devices can be connected to the Device only after being initialized.

Step 1 Click , or click  on the configuration page, and then select **DEVICE**.

Step 2 On the **Device List** page, click **Add**.

Step 3 On the **Smart Add** page, click **Smart Search**.

The search results are displayed.



To set search conditions, you can click .

Step 4 Select the uninitialized remote device and then click **Initialize** button.



Click **Initialization status** and then select **Uninitialized**, you can quickly filter the uninitialized remote device.

Figure 5-10 Initialize the device

Step 5 Set remote device password and password protection.



Using current device password and password protection information is enabled by default. Keep it enabled so as to automatically use current device admin password and email without manual configuration. Go to Step 6 if you keep it enabled.

- 1) To manually configure password, click  to disable **Using current device password and password protection information**.

Figure 5-11 Password setting

- 2) Set parameters.

Table 5-6 Description of password parameters

Parameters	Description
Username	The default username is admin.
Password	In the New Password box, enter the new password and enter it again in the Confirm Password box.
Confirm Password	The new password can be set from 8 characters through 32 characters and contains at least two types from number, letter and special characters (excluding "';:& and space). Enter a strong password according to the password strength indication.

- 3) Click **Next**.

Figure 5-12 Password protection

The screenshot shows a window titled "Device Initialization" with a close button (X) in the top right corner. A progress bar at the top contains three steps: "1 Password" (completed), "2 Password Protection" (current step, highlighted in green), and "3 Modify IP". Below the progress bar, the text "Email (To reset password)" is displayed above a text input field containing the placeholder text "Email" with an envelope icon. At the bottom right, there are three buttons: "Back", "Next", and "Cancel".

4) Set an email address.

Enter an email address. You can use the email address here to reset password in case you forgot password in the future.

Step 6 Click **Next** button.

Figure 5-13 Modify IP

The screenshot shows the "Device Initialization" window at the "Modify IP" step. The progress bar now shows "1 Password" (completed), "2 Password Protection" (completed), and "3 Modify IP" (current step, highlighted in green). Below the progress bar, there is a table with two columns: "(1) Sn" and "IP Address". The table contains two rows of blurred data. Below the table, there are radio buttons for "DHCP" (unselected) and "Static" (selected). Under the "Static" option, there are three input fields for "Static IP Address", "Subnet Mask", and "Gateway", each containing a dot as a placeholder. To the right of these fields is an "Incremental Value" input field containing the number "1". At the bottom right, there are three buttons: "Back", "Next" (highlighted in blue), and "Cancel".

- Step 7** Set camera IP address.
- When there is DHCP server in the network, select DHCP, and the remote device gets dynamic IP address automatically. It is unnecessary to enter IP address, subnet mask and gateway.
 - Select **Static**, and then enter static IP address, subnet mask, default gateway and incremental value.



- After you input incremental value, system can add the fourth address of the IP address one by one to automatically allocate the IP addresses.
- If you want to change several devices IP addresses at the same time, system allocates IP address of the same network segment.
- If there is IP conflict when changing static IP address, device pops up IP conflict dialogue box. If batch change IP address, device automatically skips the conflicted IP and begins the allocation according to the incremental value.

- Step 8** Click **Next**.
System begins initializing remote device.

Figure 5-14 Initialize

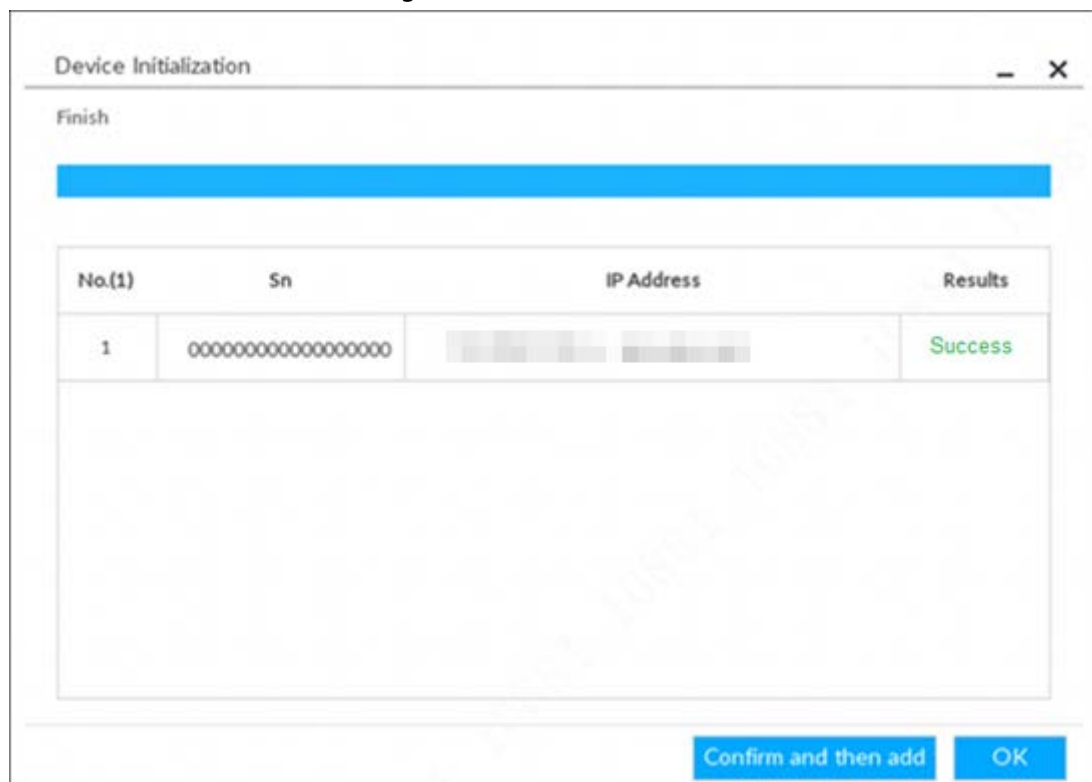

- Step 9** Click **Confirm and Add**, or click **OK**.
- Click **Confirm and Add**: System completes initializing the remote device and then adds the remote device to the list. System goes back to **Add device** page.
 - Click **OK**: System completes initializing remote device. System goes back to **Add device** page.

5.4.2 Adding Remote Device

Device supports smart add, manual add and template add.

Table 5-7 Add mode

Add Mode	Description
Smart Add	Search the remote devices on the same network and then filter to register. For details, see "5.4.2.1 Smart Add". It is useful if you do not know the exact IP address.
Manual Add	Enter the IP address, username and password of remote device. For details, see "5.4.2.2 Manual Add". For some remote devices, you can enter IP address, username, and password to register.
RTSP	Add remote devices through RTSP. For details, see "5.4.2.3 RTSP". To add stream media devices, you are recommended to choose RTSP.
Batch add (by CSV template)	Fill in information about remote device in the template, import the template to add the device. For details, see "5.4.2.4 Batch Add". For batch adding, when IP address, username and other information of remote device is inconsistent, it is suggested to use this mode.

5.4.2.1 Smart Add



- Step 1** Click  and then select **DEVICE**.
The **DEVICE** page is displayed.
- Step 2** Click  or **Add**, and then select **Smart Add** .

Figure 5-15 Smart add

Add Device
✕

Smart Add
Manual Add
RTSP
Batch Import

▶ Start Search

 Password

 Initialize

 Modify IP

<input checked="" type="checkbox"/> (1)	Initialization State	Address	Product Model	Manufacturer	Port	Product Type	Sn	Operate
<input checked="" type="checkbox"/>	✓ Initialized	192.168.1.101	148S	Onvif	80	--	--	LIVE
<input type="checkbox"/>	✓ Initialized	192.168.1.102	148S	Onvif	80	--	--	LIVE
<input type="checkbox"/>	✓ Initialized	192.168.1.103	SR_2	Onvif	80	--	--	LIVE
<input type="checkbox"/>	✓ Initialized	192.168.1.104	SR_2	Onvif	80	--	--	LIVE
<input type="checkbox"/>	✓ Initialized	192.168.1.105	136S	Private	37777	IPCAM	4M04994YA...	LIVE
<input type="checkbox"/>	✓ Initialized	192.168.1.106	136S	Private	37777	IPCAM	4M04994YA...	LIVE
<input type="checkbox"/>	✓ Initialized	192.168.1.107	136S	Private	37777	IPCAM	4M04994YA...	LIVE
<input type="checkbox"/>	✓ Initialized	192.168.1.108	0116	Private	37777	IPCAM	1.000.0000.0.R	LIVE

Total 8 Item(s) Show up to 50

Remaining Bandwidth/Total: 1024.00 Mbps/ 1024 Mbps

Step 3 Click Start Search.



To set search conditions, you can click

Figure 5-16 Search results

Add Device
✕

Smart Add
Manual Add
RTSP
Batch Import

▶ Start Search

 Password

 Initialize

 Modify IP

<input checked="" type="checkbox"/> (1)	Initialization State	Address	Product Model	Manufacturer	Port	Product Type	Sn	Operate
<input checked="" type="checkbox"/>	✓ Initialized	192.168.1.101	148S	Onvif	80	--	--	LIVE
<input type="checkbox"/>	✓ Initialized	192.168.1.102	148S	Onvif	80	--	--	LIVE
<input type="checkbox"/>	✓ Initialized	192.168.1.103	SR_2	Onvif	80	--	--	LIVE
<input type="checkbox"/>	✓ Initialized	192.168.1.104	SR_2	Onvif	80	--	--	LIVE
<input type="checkbox"/>	✓ Initialized	192.168.1.105	136S	Private	37777	IPCAM	4M04994YA...	LIVE
<input type="checkbox"/>	✓ Initialized	192.168.1.106	136S	Private	37777	IPCAM	4M04994YA...	LIVE
<input type="checkbox"/>	✓ Initialized	192.168.1.107	136S	Private	37777	IPCAM	4M04994YA...	LIVE
<input type="checkbox"/>	✓ Initialized	192.168.1.108	0116	Private	37777	IPCAM	1.000.0000.0.R	LIVE

Total 8 Item(s) Show up to 50

Remaining Bandwidth/Total: 1024.00 Mbps/ 1024 Mbps

Table 5-8 Result description

Parameters	Description
Start Search	Click Start Search to start searching remote device. Now it becomes Stop Search button. Click Stop Search button to stop searching remote device.
Password	Enter the username and password of the selected device for adding it.
Initialize	Select uninitialized remote device and then click Initialize button to initialize remote device. See "5.4.1 Initializing Remote Device". For detailed information.
Modify IP	See "8.2.2.2 Changing IP Address" to change the registered device IP address.
Initialization State	Displays remote device initialization status. Click to filter initialized or uninitialized remote device.
Operation	<ul style="list-style-type: none"> Click to set related parameters. For details, see Table 5-9. Click to display real-time video from the remote device. Click or Close to close the real-time preview window. <p>You can view the live video if admin password of the remote device is admin, or remote device admin password is the same as the system.</p>
Bandwidth	Displays bandwidth remaining and the total bandwidth.

Figure 5-17 Live view

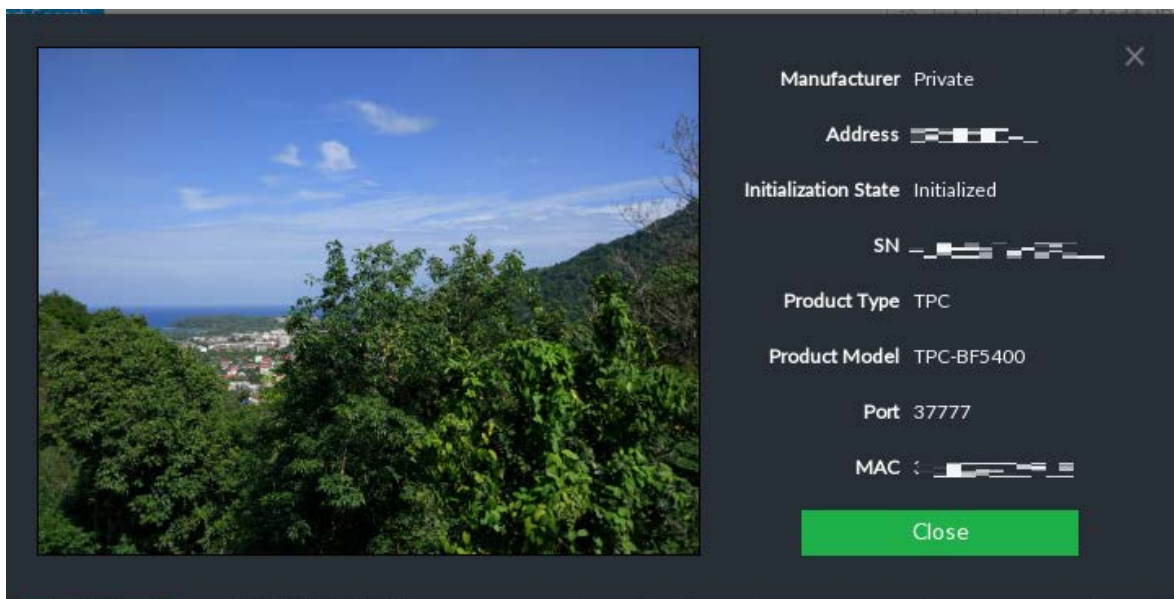

Step 4 Adding a remote device.

Select a remote device, click **Password**, and then enter the username and password of the selected device. Click **OK**.



- If you do not enter device username and password, the system will try to add the device by using the username and password of the Device.
- During the adding process, click **Cancel** button, you can cancel adding process. Click **Stop** button of the corresponding remote device to cancel add.

Step 5 Click **Add**.



- Click remote device IP address, username, password, SN, channel and port to change corresponding information.
- If system fails to add the remote device, see the reason on the **Status** column to change the remote device information and then click **Retry** to try to add again.
- If a remote device is in exception due to network disconnection other reasons, it can also be added. It comes online after the exception is resolved.

Step 6 Click **Continue to add** or **Finish**.

- Click **Continue to add**, device goes back to the **Smart Add** page to add more remote device.
- Click **Finish** to complete adding remote device process. You can view the newly added remote device information on the device list.

5.4.2.2 Manual Add

Step 1 Click and then select **DEVICE**.

Step 2 Click and then select **Manual add**.

Step 3 Click **Add Device**.

Figure 5-18 Add device

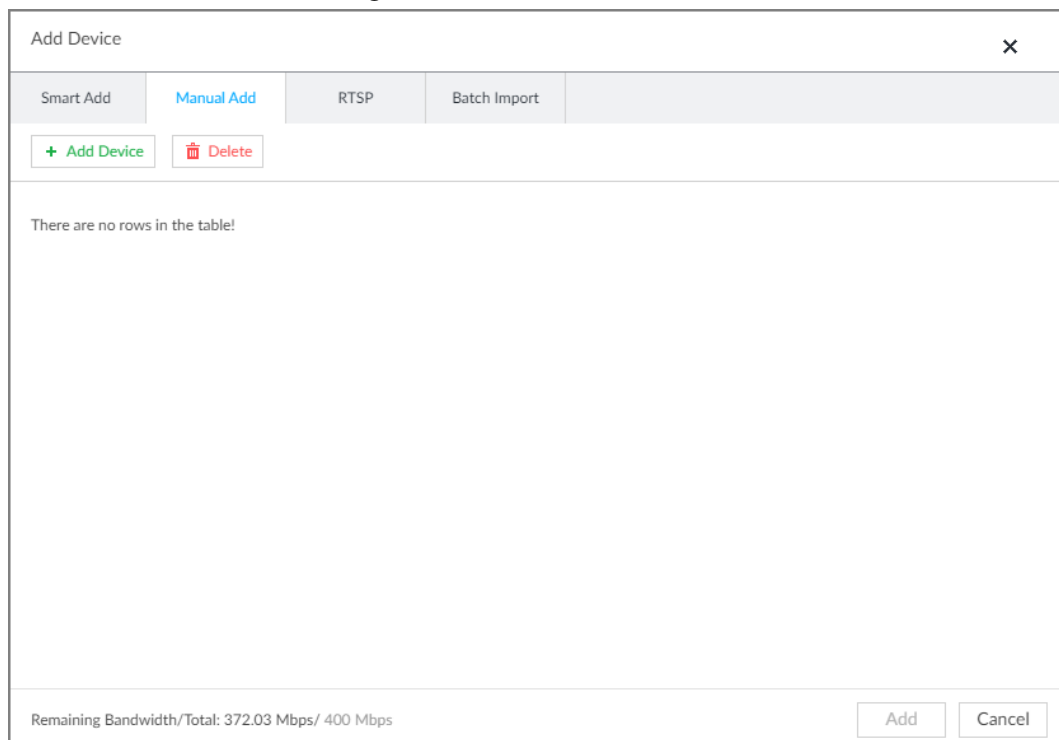

Step 4 Set parameters and then click **OK**.

Figure 5-19 Remote device setting

The screenshot shows a 'Setting' dialog box with the following fields and options:

- Channel No.: Auto Allocation (dropdown)
- Manufacturer: Private (dropdown)
- IP Address: (empty text box)
- Port: 37777 (text box, with range (1025-65535) indicated)
- User Name: admin (text box)
- Password: (masked text box)
- Link Type: Self-Adaptive (selected), TCP, UDP, Multicast (radio buttons)
- Total Channels: 1 (text box) with a 'Connect' button
- Select: 1 - 1 (text boxes) with 'Selected' and 'Clear' buttons
- Remote CH No.: 1 (text box)

Buttons at the bottom right: OK, Cancel.

Table 5-9 Parameters of adding device

Parameters	Description
Channel No.	Select a channel number for the remote device on IVSS. If you select Auto Allocation , IVSS will provide a channel number automatically.
Manufacturer	Displays the connection protocol of the remote device. Default protocol of the system is Private . Click Private to select other protocols.
IP Address	Enter the IP address of the remote device.
Device SN	Enter the unique SN allocated by the server for the remote device. When the Manufacturer is Register, you need to configure this parameter.
RTSP Port	Enter the RTSP port number. The default port number is 554. The value ranges from 1 through 65535.
RTSP Mode	Select Self-adaptive or Customize . When the Manufacturer is Onvif or Onvifs, you need to configure this parameter.
HTTP Port	Enter the HTTP port number. The default port number is 80. The value ranges from 1 through 65535. After changing the HTTP port number, you need to add the HTTP port number to the IP address in the address bar of the browser for login.
HTTPS Port	Enter the HTTP port number. The default port number is 80. The value ranges from 1 through 65535. When the Manufacturer is Onvifs, you need to configure this parameter.
User Name	Enter the username and password of the remote device.
Password	

Parameters	Description
Port	Enter the port number of the remote device.  When the Manufacturer is Private , you need to configure this parameter.
Remote CH No.	Select the channel number for the remote device. <ol style="list-style-type: none"> 1. Select a link type. 2. To get the total number of channels, click Connect. 3. Enter the range of channels you need, and then click Selected. 4. Click OK.

Step 5 Select the remote device and then click **Add**.



- If system fails to add the remote device, see the reason on the **Status** column to change the remote device information and then click **Retry** to try to add again.
- If a remote device is in exception due to network disconnection other reasons, it can also be added. It comes online after the exception is resolved.

Figure 5-20 Confirm

Address	Username	Password	Manufacturer	Port	Status	Operate
[redacted]	admin	****	Private	37777	Added	

Bandwidth : 12.552Mbps/768Mbps

[Continue to add](#) [Finish](#)

Step 6 Click **Continue to add** or **Finish**.

- Click **Continue to add**, device goes back to **Smart add** page to add more remote device.
- Click **Finish** to complete adding remote device process. Device displays **Device** page to view the newly added remote device information.

5.4.2.3 RTSP

Step 1 Click  and then select **DEVICE**.

- Step 2** On the **Device List** page, click **Add**.
The **Add Device** page is displayed.
- Step 3** Click **RTSP**.
- Step 4** Enter RTSP address as required.
RTSP address format is `rtsp://<username>:<password>@<IP address >:<port>/cam/realmonitor?channel=1&subtype=0`.
- Username: Username of the remote device.
 - Password: Password of the remote device.
 - IP address: IP address of the remote device.
 - Port: 554 by default.
 - Channel: The channel number of the stream media device to be added.
 - Subtype: Stream type. 0 for main stream, and 1 for sub stream.
- Step 5** Select a channel No.
- Step 6** Click **Add**.

5.4.2.4 Batch Add



- Step 1** Click , and then select **DEVICE**.
- Step 2** Click , and then click the **Batch Import** tab.

Figure 5-21 Import CSV file

Manufacturer	Address	User Name	Password	Port	Channel No	Remote CH No.

- Step 3** Fill in template file.
- 1) Click **Download Template** to download template file.
File path might vary depending on your operations.
 - At PCAPP, click , select **Download** to view file saving path.
 - During local operation, you can select file saving path.
 - During web operations, files are saved under default downloading path of the browser.

2) Fill in and save the template file.

Step 4 Import template file.

1) Click **Browse** to select the file that you have filled in.

2) Select an import mode and then click **Import**.

- **Overwrite:** The system removes the added remote devices before importing new devices.



If you select **Overwrite**, all the existing devices will be deleted.

- **ADD:** The system imports remote devices without deleting the existing ones.

Figure 5-22 Batch import

Manufacturer	Address	User Name	Password	Port	Channel No	Remote CH No.

Step 5 Select the remote device and then click **Add**.



- If information about remote device is not filled in completely, improve it after importing template.
- If the system fails to add the remote device, check the reason on the **Status** column, change the remote device information and then click **Retry** to try to add again.

Figure 5-23 Confirm

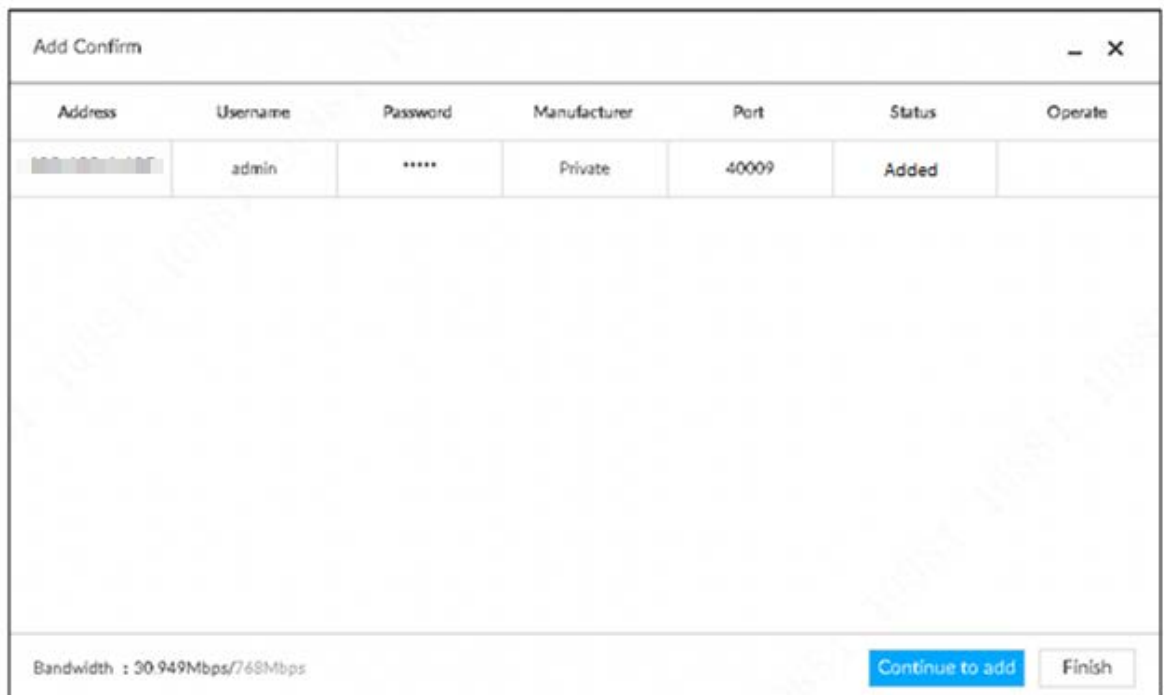

Address	Username	Password	Manufacturer	Port	Status	Operate
[redacted]	admin	****	Private	40009	Added	

Bandwidth : 30.949Mbps/768Mbps

[Continue to add](#) [Finish](#)

Step 6 Click **Continue to add** or **Finish**.

- Click **Continue to add**, device goes back to **Smart add** page to add more remote device.
- Click **Finish** to complete adding remote device process. Device displays **Device manager** page to view the newly added remote device information.

6 AI Operations

In addition to the basic video monitoring functions, the Device can also provide a number of AI functions including face recognition, people counting, video metadata, ANPR, and IVS (behavior detections such as fence-crossing, intrusion, loitering, crowd gathering, parking and more.).

This chapter introduces how to configure the AI functions respectively.

The AI detections can be done by camera (AI by camera) or by IVSS (AI by device).

- AI by camera: When configuring an intelligent detection, if you select AI by camera, the intelligent analysis job is completed on the camera, and the Device just receives and processes the results.
- AI by device: When configuring an intelligent detection, if you select AI by device, the camera uploads video and snapshots, and then the Device is responsible for the video analysis job.



- The AI functions might vary depending on the device function capability.
- When AI by camera is enabled, complete AI detection configuration at remote device. See remote device user's manual.
- The **AI by Camera** tab does not appear if the current camera does not support this function.

6.1 Overview

Viewing Event Enabling Status

View the usage status of the AI functions of all remote devices.

Click at the upper-right corner of the homepage to open the **Event** page. The **Overview** page is displayed by default, which shows the usage status of the AI functions of all remote devices.

Figure 6-1 Overview

Filter		DEVICE INFO		Face	Video Metadata	IVS	Vehicle	Crowd Dete...	Call Dete...	Seeking D...	People Co...	Video Detect
Channel No	State	Channel	Address/Regist ID									
SP	●	10010739AW00124		●	●	●	●				●	●
1	●	IPC		●	●	●					●	●
2	●	camera2					●					
3	●	camera3										
4	●	camera4										
5	●	26										
6	●	IPC										●
7	●											●
8	●											●
9	●	171										●
10	●	179						●				●
11	●	5			●	●	●					●



- indicates that the AI by camera is enabled. ● indicates that AI by device is enabled.

AI Events by Device or Camera

Table 6-1 AI Events by Device or Camera

AI Event	AI by Camera	AI by Device
Face Detection	Yes	Yes
Face Recognition	Yes	Yes
People Counting	Yes	No
Video Metadata	Yes	Yes
IVS	Yes	Yes
Crowd Distribution	Yes	No
Call Alarm	Yes	No
Smoking Alarm	Yes	No
Vehicle Recognition	Yes	No
Plate Comparison	No	Yes

6.2 Face Detection

System triggers alarms when human faces are detected within the detection zone.

6.2.1 Enabling AI Plan

To use AI by camera, you need to enable AI plan first.



- AI plan is available on select models.
- The Device automatically shows the AI functions available on the connected cameras.

Step 1 Click or click on the configuration page, and then select **EVENT**.
The **EVENT** page is displayed.

Step 2 Select a camera in the device tree on the left.

Step 3 Select **AI Application > AI Plan > AI Plan**.



- The page might vary depending on the function capabilities of cameras.
- When the camera is a PTZ camera, configure presets on the camera system first, and then you can set AI features for each preset of the PTZ camera.

Step 4 Click to enable AI detection plan. The icon becomes .
When there is a conflict between the to-be-enabled AI plan and an enabled plan, disable the enabled plan first.

Step 5 Click **Save**.

6.2.2 Configuring Face Detection

Configure alarm rule of face detection.

Step 1 Click or click on the configuration page, and then select **EVENT**.

- Step 2** Select a remote device in the device tree on the left.
- Step 3** Select **AI Plan > Face Detection**.

Figure 6-2 AI by camera

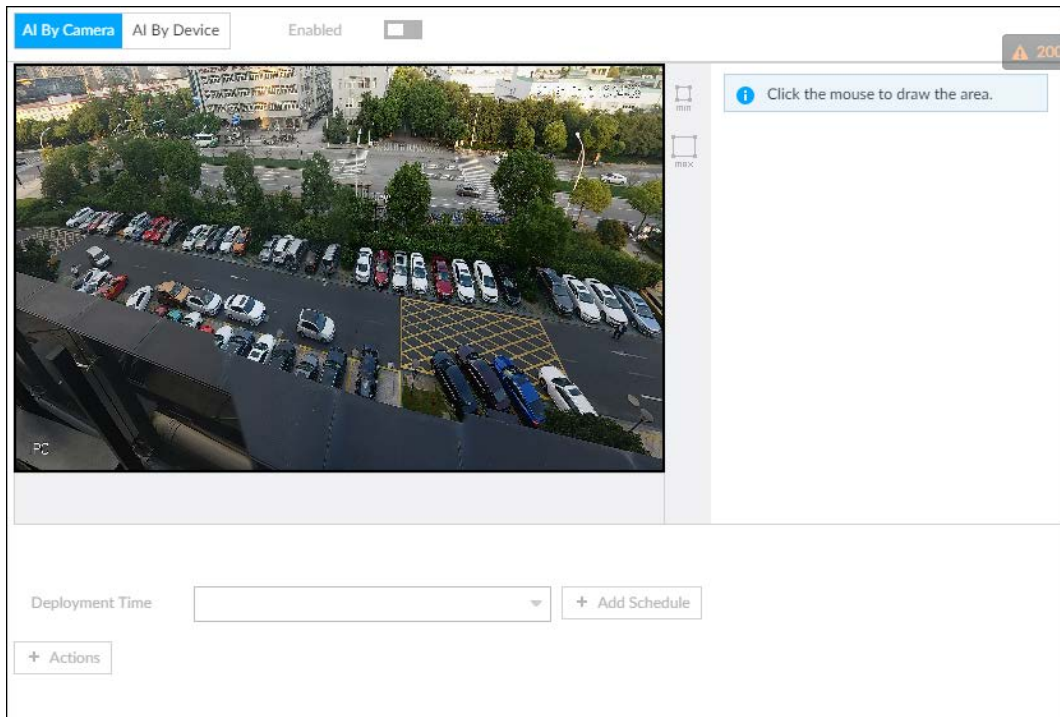
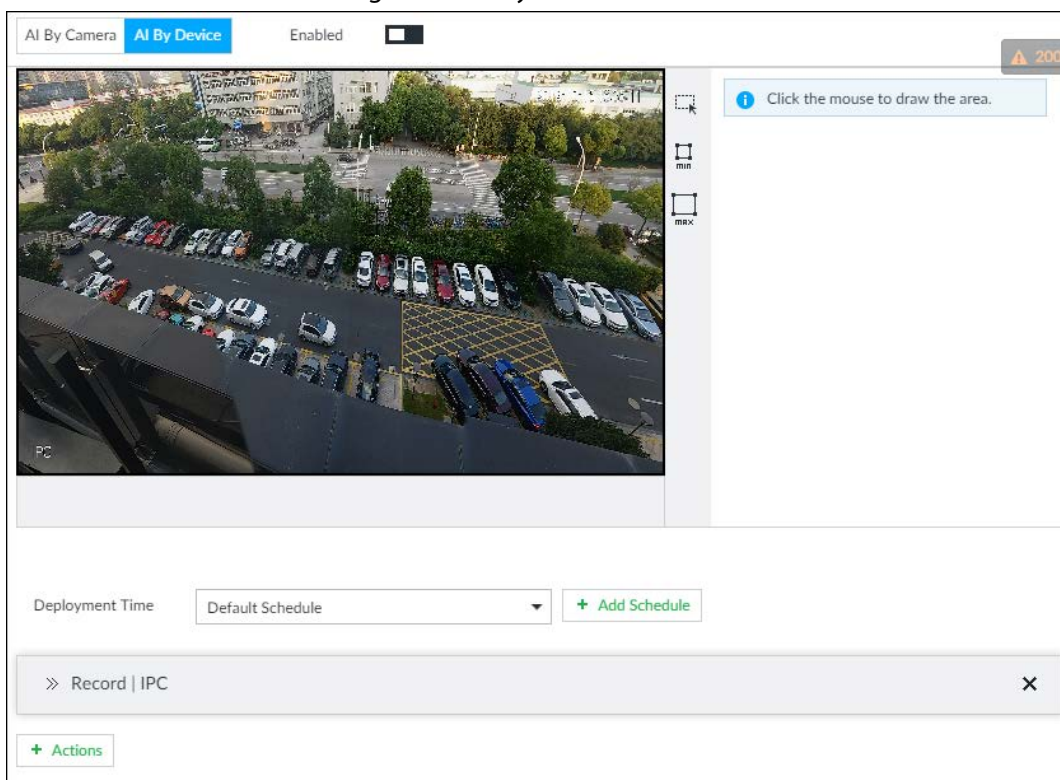

Figure 6-3 AI by device



- Step 4** Click **AI by camera** or **AI by device**, and then click to enable face detection.



AI by camera supports **Face Enhance** function. After enabling **Face Enhance** function, system displays enhanced human face zone on the surveillance window.

Step 5 Set detection area on the video (yellow area).

Figure 6-4 Area



- Click or white dot on detect region frame, and drag to adjust its range.
- Click or to set the minimum size or maximum size of the face detection area. System triggers an alarm once the size of detected target is between the maximum size and the minimum size.

Step 6 Click **Deployment Time** to select a schedule from the drop-down list. System triggers corresponding alarm actions only during the alarm deployment period.



You can select an existing schedule from the **Deployment Time** drop-down list. You can also add a new schedule. For details, see "8.8.4 Schedule".

Step 7 Click **Action** to set alarm action. See "8.4.1 Alarm Actions" for detailed information.

Step 8 Click **Save**.

6.2.3 Live View of Face Detection

You can view real-time face detection images and video.

6.2.3.1 Setting AI Display

You can configure display rule of face detection results.



Before using this function, ensure that view has been created. See "7.1.1 View Management" for detailed information.

Step 1 On the **LIVE** page, click and select the **Face** tab.



- Click **Sync from AI-Dis.**, obtain global smart detection display rule of IVSS. See "8.4.2.4.2 Setting AI Display" for detailed information.
- Click **Apply to all windows** to copy current configuration to other window(s).

Figure 6-5 Face

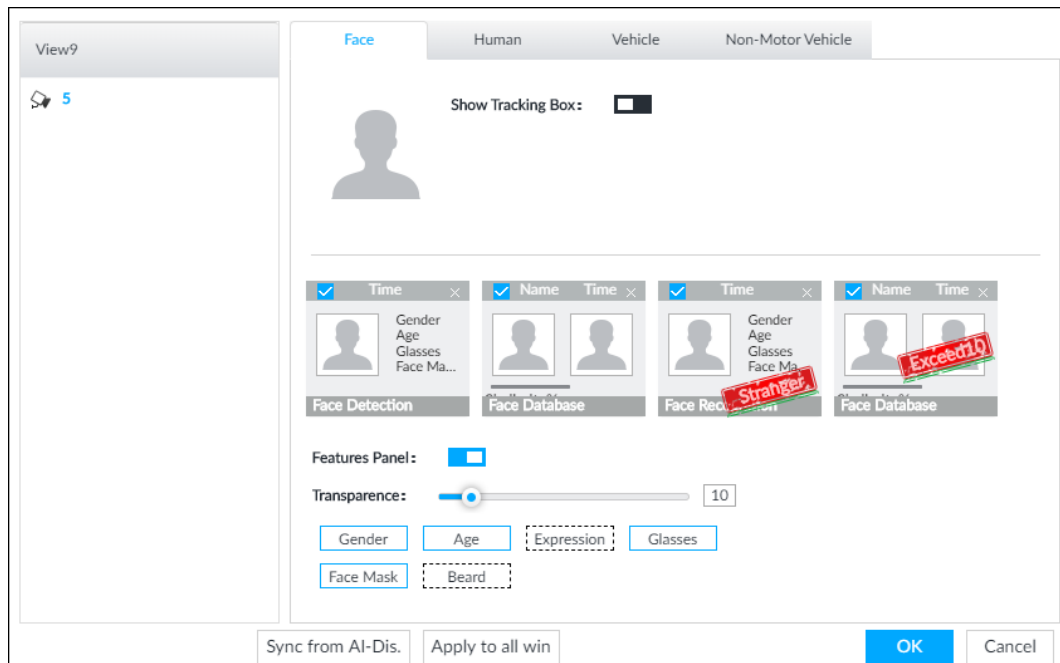

Step 2 Enable **Show Tracking Box** by clicking .

After it is enabled, when the system detects face or human, the window will display corresponding rule box.

Step 3 Enable **Features Panel**, and select feature(s) you want to display.

- 1) Click next to **Features Panel**, to enable the function. When the panel is enabled, the snapshots of detected faces are displayed on the live view.
- 2) Click to select **Face Detection** tab. indicates that the panel is selected.
- 3) (Optional) Drag to adjust features panel transparency. The higher the value, the more transparent the features panel.
- 4) (Optional) Select the features you need to display.
 - System supports displaying 4 feature types.
 - System has checked four features by default. To select other features, cancel the selected features, and then select the ones you need.

Step 4 Click **OK** to save the configuration.

6.2.3.2 Live View

Go to the **LIVE** page, enable view, and then view videos are displayed.

- The view window displays currently detected face rule boxes.
- Features panels are displayed on the right side in real time.
- The features panel displays detection time, face snapshot and face features details.

Figure 6-6 Live

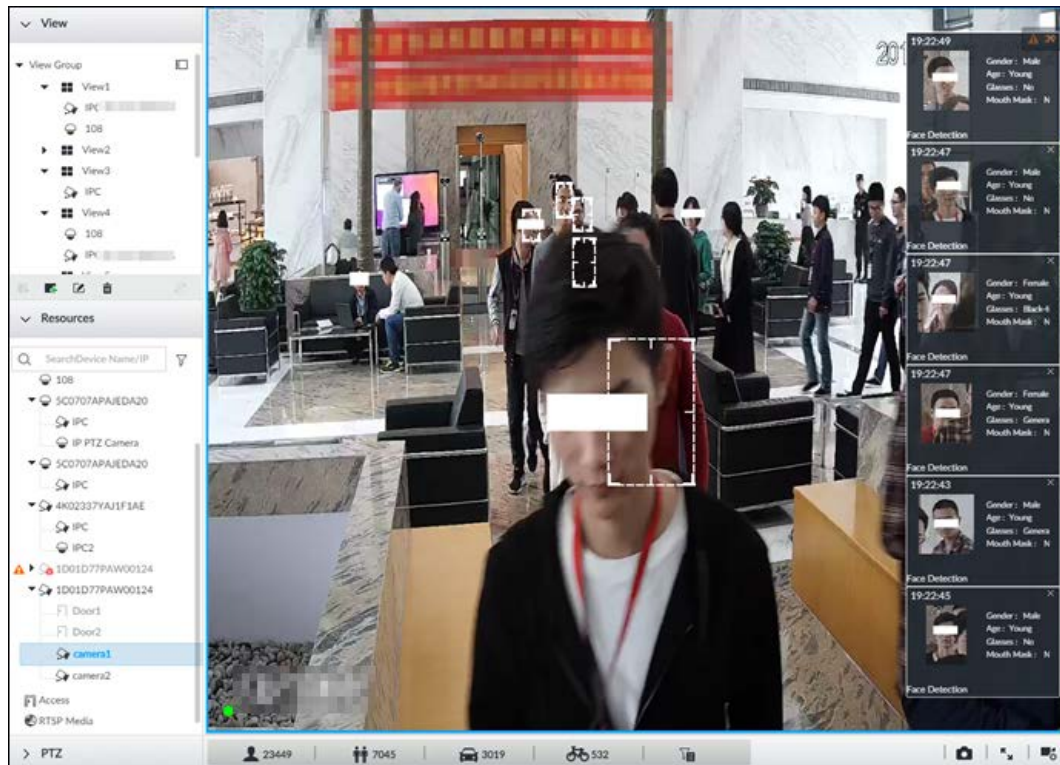

Point to a features panel, and the operation icons are displayed.

Figure 6-7 Face database

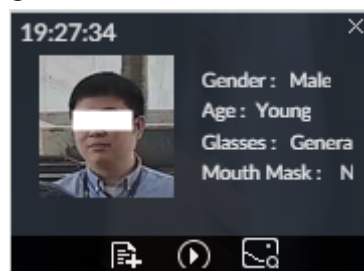

- Click to add this image to the face database. See "6.8.3.2.3 Adding from Detection Results" for detailed information.
- Click or double-click the detected image, so the system starts to play back the recorded videos (about 10s) at the time of snapshot.
- Click to open the **Search by Face** page where you can use this face image to search all history face records for the appearance records of the current face.





6.2.3.3 Face Records

On the **LIVE** page, click . The **FACE TOTAL** page is displayed. Click , and then select **Face Detection**. The latest face detection records are displayed.

Figure 6-8 Detection image



On the **FACE TOTAL** page, the following operations are available.

- Point to a piece of face record, click , and then you can quickly add this image to the face database. See "6.3.3.4.3 Adding Face Image" for detailed information.
- Point to a piece of face record, click  or double-click the detected image, and then the system starts to play back the recorded videos (about 10s) at the time of snapshot.
- Point to a piece of face record, click , and then you can save that record locally including the video and pictures.
- Point to a piece of face record, click , and then the system automatically searches videos and face pictures of all channels for the similar face in the defined period.

6.2.4 Face Search

Search for face detection information, including face detection image, record and features.

6.2.4.1 Searching by Property

Step 1 On the **LIVE** page, click , and then select **AI SEARCH > Search by Face > By Property**.

Figure 6-9 Search by property

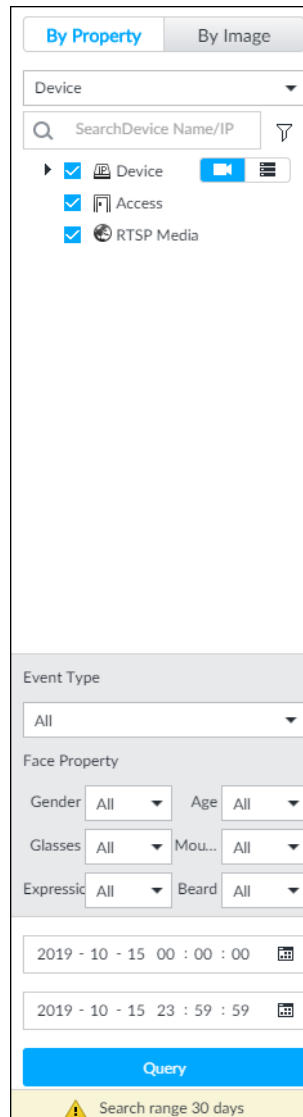

Step 2 Select a remote device, and then set **Event Type** to be **Face Detection**.

In the **Event Type** drop-down list, if you select **All**, the search results will include both face detection records and face recognition records.

Step 3 Set face property and time.

Step 4 Click **Query**.

The search results are displayed.

Figure 6-10 Search results

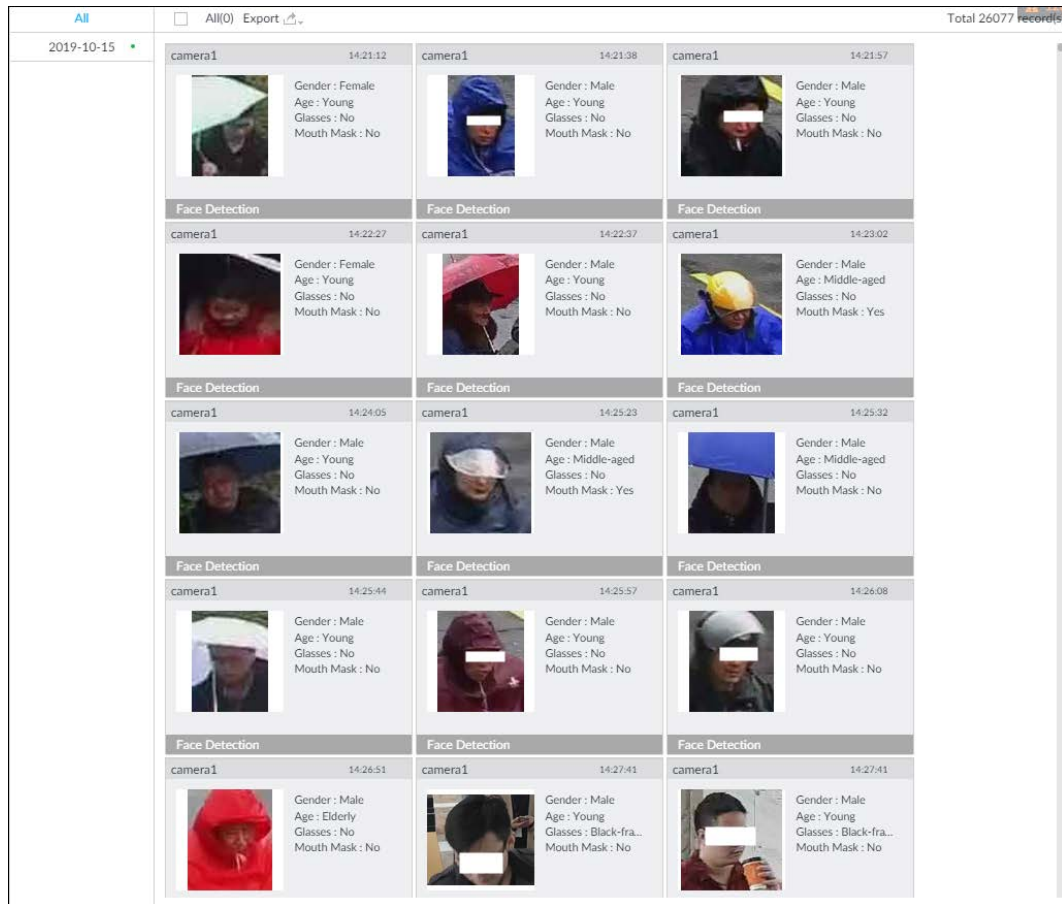

Point to a piece of record, and then the following icons are displayed.

Figure 6-11 Icons



Table 6-2 Description

Icon	Operation
<input type="checkbox"/>	<ul style="list-style-type: none"> Select one by one: Click the panel or move the mouse pointer onto the panel, and then click <input type="checkbox"/> to select the panel. <input checked="" type="checkbox"/> means it is selected. Batch select: Check All to select all panels on the page.
	Click or double-click the panel, the system starts to play back the recorded videos (about 10s).
	Click to quickly add the image to the face database. See "6.3.3.4.3 Adding Face Image" for detailed information.

Icon	Operation
	<ul style="list-style-type: none"> Export one by one: Click to export picture, video and video player. For details, see "6.2.4.3 Exporting Face Records". Export in batches: Select the panel and click to export picture, video or excel. For details, see "6.2.4.3 Exporting Face Records". <p></p> <p>After setting alarm linkage snapshot, during exporting images, the system exports detected images and panoramic images at the time of snapshot.</p>
	Click , and then the system automatically searches all channels for the records of the current face.

6.2.4.2 Searching by Image

Upload a face picture to search for similar faces.

You can select the to-be-uploaded face picture from local files or the face database.

- When you use face database images to search, ensure face database has been configured. See "6.3.3.4 Configuring Device Face Database" for detailed information.
- If you want to use the local images, you need to obtain the face image and save it in the corresponding path.
 - ◊ When operating on the local interface, save the image in the USB storage device and then connect the USB storage device to the Device.
 - ◊ When operating on the web or PC client, save the image on the PC in which the Web or PCAPP is located.



The function of search by image is not available with AI by Camera.

6.2.4.2.1 Searching Devices

Upload face image, compare it with face detection result of remote device, and find face detection information that meets the similarity.

Step 1 On the **LIVE** page, click , and then select **AI SEARCH > Search by Face > By Image**.

Step 2 Click the **Device** tab.

Step 3 Upload a face image.



Device supports uploading maximum 50 face images. Device supports selecting maximum 10 face images at one time.

- Upload the image from the face image database to search for corresponding face.

1) Click and select **Staff Database Image**.

Figure 6-12 Choose picture from face database

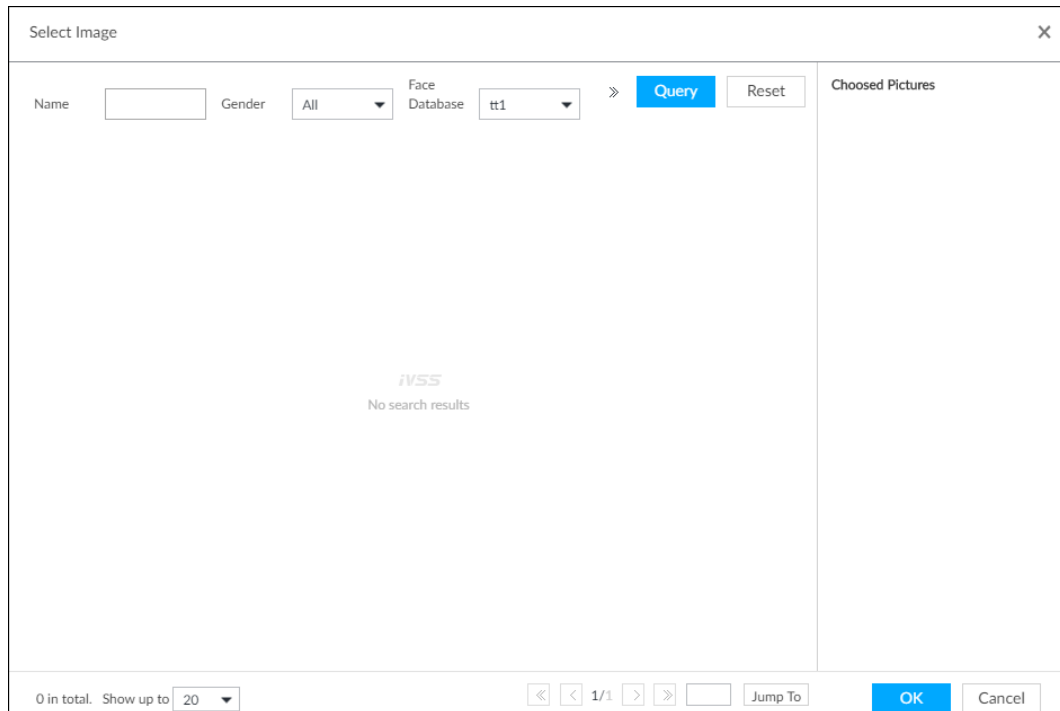

2) Specify search conditions.

3) Click **Query**.

4) Select a face image.

5) Drag  to set similarity.

6) Click **OK** to upload face image.

- Upload the image from the passerby database.

1) Click  and select **Passerby Database**.

2) Specify search conditions.

3) Click **Query**.

4) Select a face image.

5) Click **OK** to upload face image.

- Local image: Upload images from the client PC or USB storage device connected to the Device.

1) Click  and select **Local**.

2) Select the face image you want to upload.



You can select several face images at the same time.

3) Drag  to set similarity.

4) Click **OK** to upload face image.

After uploading the images, device displays the face images on the upper-left corner. The latest 10 images are selected.

Figure 6-13 By image

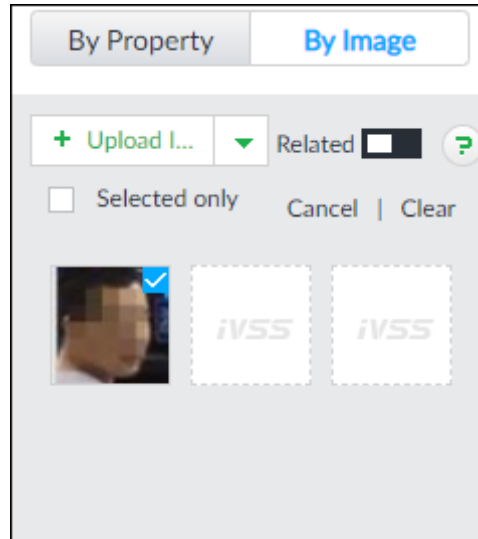

- When the uploaded image is half-length photo or full-body photo, the system automatically selects the frame of the uploaded image and only the face area will be retained.
- When there are multiple faces in the uploaded images, the system automatically identifies the faces in the images and uploads multiple face images according to the number of faces recognized.
- Device supports selecting maximum 10 face images.
- Click **Cancel** to cancel all selected face images.
- Select **Selected only**, device displays selected human face images only.
- Click **Clear** to clear all uploaded face images.

Step 4 (Optional) Click to enable related search. If related search is enabled, the system searches for both face detection results and human detection results.

Step 5 Hold on and drag to set human face similarity. It is 80% by default.

Step 6 Select remote device on the device list and then set record file time period.

Step 7 Click **Query**.

Figure 6-14 Search results

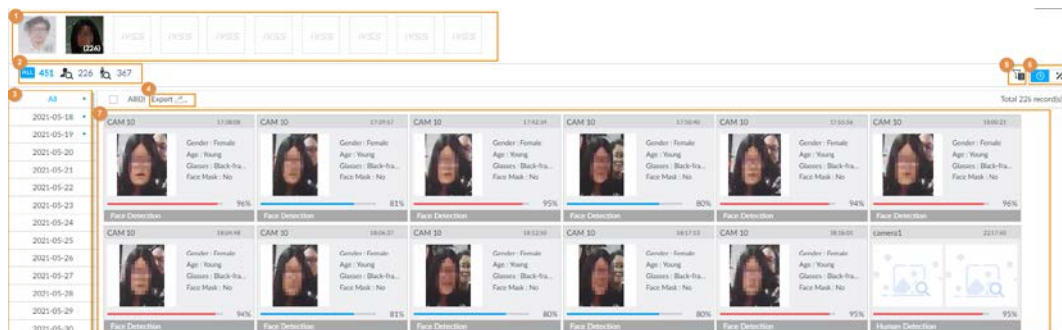

Table 6-3 Search results page description

No.	Function
1	<ul style="list-style-type: none"> • Displays the selected search images. The number at the lower-right corner of the image represents the number of records found. • Click the image to view detailed results.

No.	Function
2	<ul style="list-style-type: none"> • : displays the number of images found. • : Displays the number of face images found. • : Displays the number of human body images found. <p>The numbers are displayed only when related search is enabled.</p>
3	<ul style="list-style-type: none"> • Displays the dates within the selected search range. • Click a date and the records of that day are displayed.
4	Select the panel and click to export picture, video or excel. For details, see "6.2.4.3 Exporting Face Records".
5	Filter the search results according to properties.
6	<ul style="list-style-type: none"> • : Sort the records by time. • : Sort the records by similarity.
7	Displays the face panels, including face image, feature property and similarity.

6.2.4.2.2 Searching Face Database

Upload face image, compare it with face image in face database, and find face image that meets the similarity.

Step 1 On the **LIVE** page, click , and then select **AI SEARCH > Search by Face > By Image**.

Step 2 Click the **Face Database** tab.

Step 3 Upload face image.

Step 4 (Optional) Click to enable related search. If related search is enabled, the system searches for both face detection results and human detection results.

Figure 6-15 Related

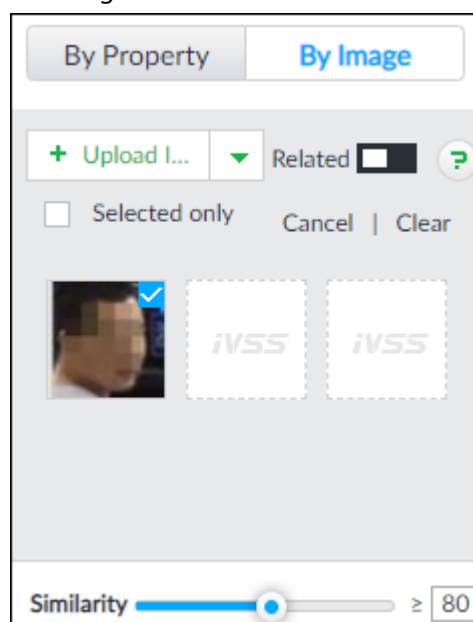

Step 5 Hold on and drag to set human face similarity. It is 80% by default.

Step 6 Select the face database.

Step 7 Click **Query**.

Figure 6-16 Search results

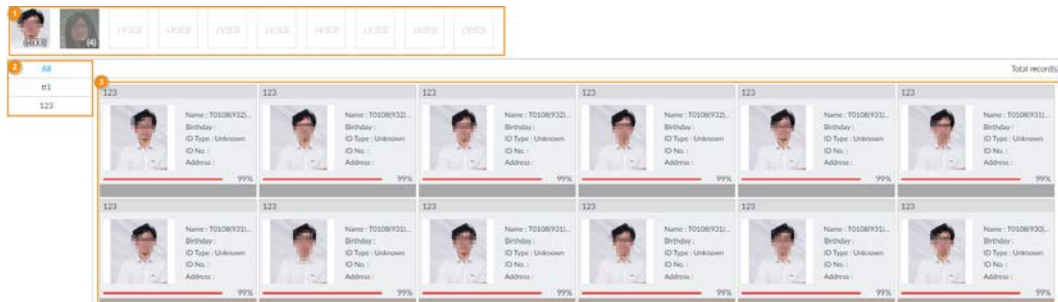

Table 6-4 Search results page description

No.	Function
1	<ul style="list-style-type: none"> Displays the selected search images. The number at the lower-right corner of the image represents the number of records found. Click the image to view detailed results.
2	<ul style="list-style-type: none"> Displays the dates within the selected search range. Click a date and the records of that day are displayed.
3	Displays the face panels, including face image, feature property and similarity.

6.2.4.2.3 Searching Task Lists

Upload face pictures to search for analyzed images of similar faces. For details about AI tasks, see "7.4.1 AI Analysis Task".

- Step 1** On the **LIVE** page, click **+**, and then select **AI SEARCH > Search by Face > By Image**.
- Step 2** Click the **Task List** tab.
- Step 3** Upload a face picture.
- Step 4** (Optional) Click to enable related search. If related search is enabled, the system searches for both face detection results and human detection results.

Figure 6-17 Related

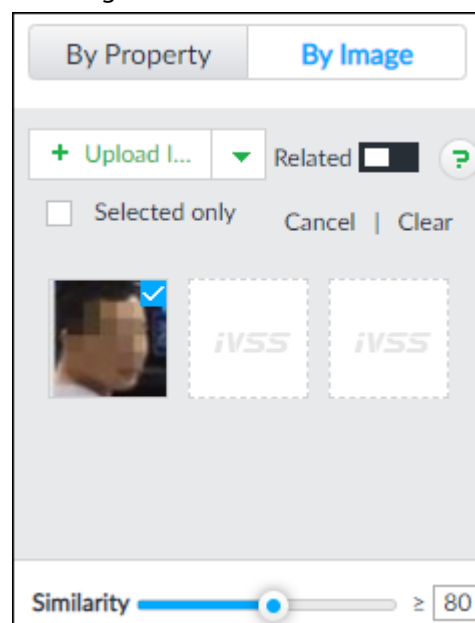

- Step 5** Drag to set similarity. It is 80% by default.
- Step 6** Select one or more tasks.

Step 7 Click Query.

Figure 6-18 Search results

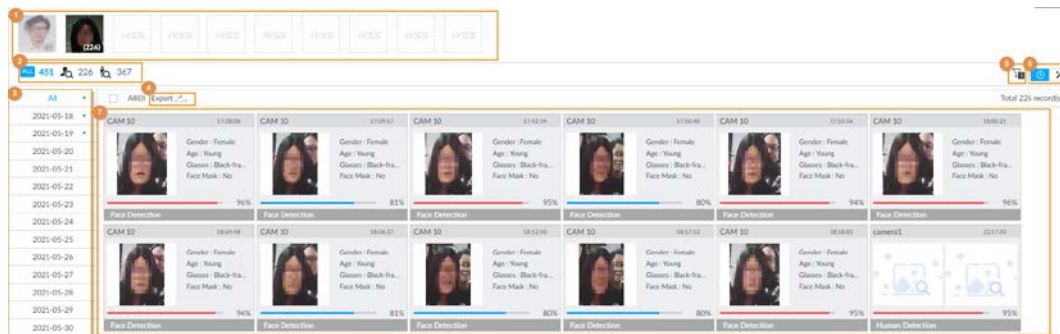

Table 6-5 Search results page description

No.	Function
1	<ul style="list-style-type: none"> Displays the selected search images. The number at the lower-right corner of the image represents the number of records found. Click the image to view detailed results.
2	<ul style="list-style-type: none"> : displays the number of images found. : Displays the number of face images found. : Displays the number of human body images found. <p> The numbers are displayed only when related search is enabled.</p>
3	<ul style="list-style-type: none"> Displays the dates within the selected search range. Click a date and the records of that day are displayed.
4	Select the panel and click to export picture, video or excel. For details, see "6.2.4.3 Exporting Face Records".
5	Filter the search results according to properties.
6	<ul style="list-style-type: none"> : Sort the records by time. : Sort the records by similarity.
7	Displays the face panels, including face image, feature property and similarity.

6.2.4.3 Exporting Face Records

The search results of face records can be exported. You can select to export video, picture and excel that contain detailed information.



- Make sure that you have inserted USB storage device into your IVSS.
- The exported alarm-linked snapshot contains the face snapshot and the background picture.
- To save the background picture, make sure that you have configured alarm-linked snapshot storage.

The search results are displayed as follows.

Figure 6-19 Search results of face records

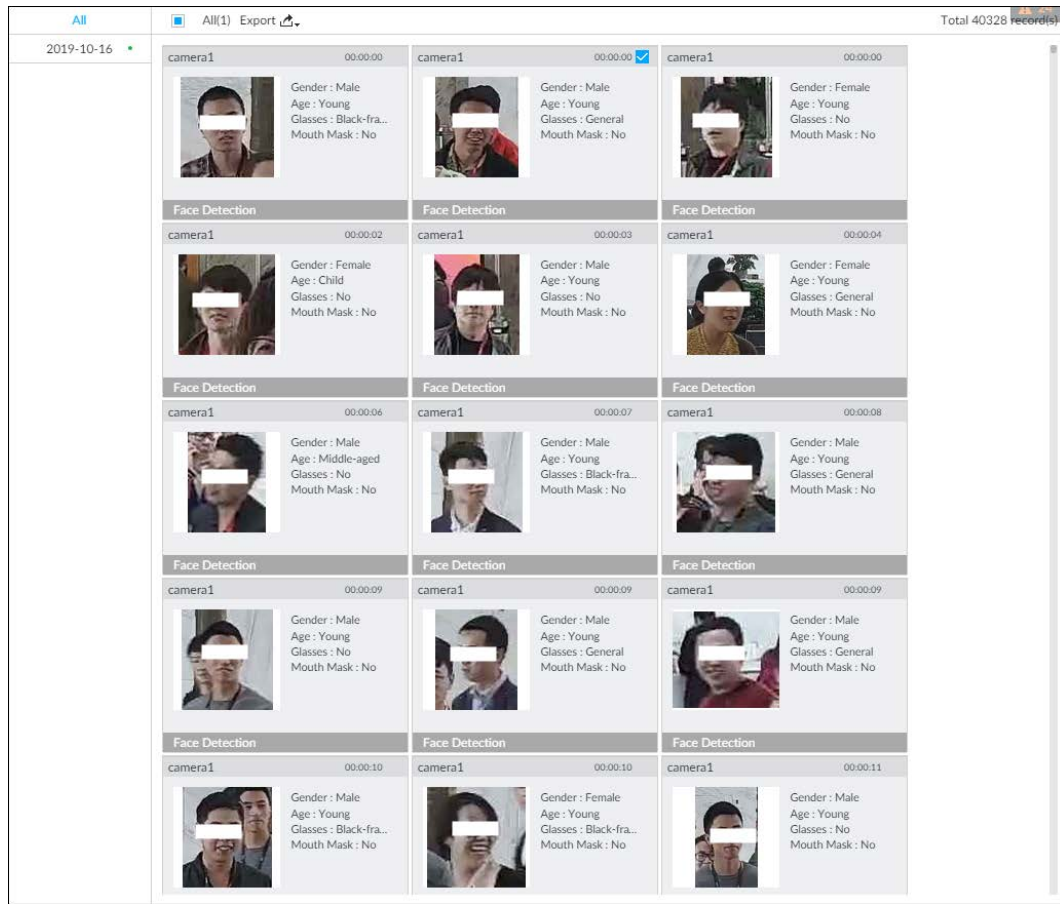

- Export in batches

Export more than one record. Support specifying file formats.

Step 1 Select more than one record.



To export all records, select the checkbox of **All**.



Step 2 Click , and then select file formats.

Figure 6-20 File format

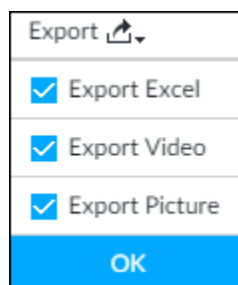

Step 3 Click **OK**, and then follow the onscreen instructions to finish exporting.

- Export one by one
 1. Point to a piece of record, and then click .
 2. The **Save** page is displayed.
 3. Select a file type between DAV and MP4, set the saving path, and then click **OK**.

Export one piece of record. The exported file contains picture, video and video player by default.

6.3 Face Recognition

The system compares captured face with the face database and works out the similarity. When the similarity reaches the threshold as you have defined, an alarm will be triggered.

6.3.1 Configuration Modes

Face recognition can be configured in the following modes:

- Face recognition by camera. For details, see "6.3.2 Face Recognition by Camera".
- Face detection by camera+ face recognition by device. For details, see "6.3.3 Face Detection by Camera + Face Recognition by Device".
- Face recognition by camera + face recognition by device. For details, see "6.3.4 Face Recognition by Camera + Face Recognition by Device".
- Face detection by device + face recognition by device. For details, see "6.3.5 Face Detection by Device + Face Recognition by Device".
- Video metadata by camera or by device + face recognition by device. For details, see "6.3.6 Video Metadata + Face Recognition by Device".

6.3.2 Face Recognition by Camera

6.3.2.1 Configuration Procedure

Figure 6-21 Configure face recognition (AI by camera)



6.3.2.2 Enabling AI Plan

To use AI by camera, you need to enable the corresponding AI plan first. For details, see "6.2.1 Enabling AI Plan".

6.3.2.3 Configuring Remote Face Database

The Device can get face databases from the remote devices, and also allows creating face databases for remote devices. The remote device face database is suitable for face recognition AI by Camera.



You cannot view face image information on the remote devices from the Device.

6.3.2.3.1 Creating Face Database for Remote Devices

Procedure

- Step 1** On the **LIVE** page, click **+**, and then select **FILE > Face Management > Face Database > Remote**.
- Step 2** Select a remote device from the **Remote Device** drop-down list.
- Step 3** Click **Create**.

Step 4 Enter **Face database name**.

Figure 6-22 Create a face database for remote devices

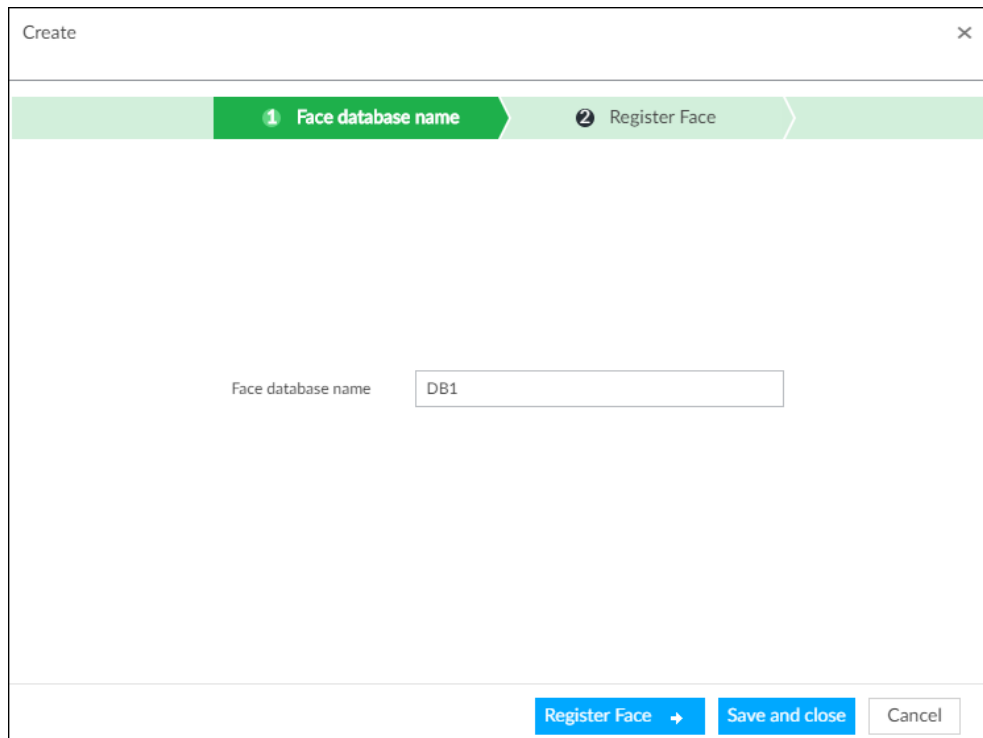

Step 5 Click **Register Face** or **Save and close**.

- To add faces into the database, click **Register Face**. For details, see #d1415e7a1026.
- To save and exit, click **Save and close**.

Related Operations

- View face database details and status.

Figure 6-23 Face database



- ◇ 1: Face database name. To modify, click .
- ◇ 2: Number of face images in the face database.
- ◇ 3: Number of face images that failed to abstract. For details about face abstracting, see "6.3.3.4.5 Human Face Abstract".
- ◇ 4: Face recognition devices associated to this face database.
- To arm the face database, see "6.3.2.4 Configuring Face Recognition (by Camera)".
- To delete face databases:
 - ◇ One by one: Click .

- ◇ In batches: Hover over the face database, and then select the database by clicking . After selecting multiple databases, click
- ◇ Delete all: Select **All**, and then click
- To clear a face database, select the face database, and then click **Clear**.

6.3.2.3.2 Adding Face Images for Remote Devices

Add face images to the created face database in the way of manual add, batch import, or bin import.



Make sure that you have obtained the face image and saved it in the proper path.

- When operating on the local interface, save the images in the USB storage device and then connect the USB storage device to the Device.
- When operating on the web or PCAPP interface, save the images on the PC you are using.

Manual Add

You can add human face image one by one. If the registered human face image quantity is small, you can use manual add mode.

1. On the **LIVE** page, click , and then select **FILE > Face Management > Face Database > Remote**.
2. Double-click a face database.
3. Click **Manual Add**.
4. Click and select face image.

Figure 6-24 Face register



- When the uploaded image is half-length photo or full-body photo, the system automatically selects the frame of the uploaded image and only the face area will be retained.
- When there are multiple faces in the uploaded images, the system automatically identifies the

faces in the images and uploads multiple face images according to the number of faces recognized. Select face image you want to upload. Blue frame means that it is selected.

- Click **Cancel** to cancel all checked face images.

5. Click **OK** and import face image.



Point to the face image and then click **Change Image** to change it.

6. Fill in face image information.

Figure 6-25 Face information

7. Click **Save and continue to add** or **OK**.

- Click **Save and Continue to add** to save current face image information and add another human face image.
- Click **OK** to save current face image information and complete registration.

After adding the image, at the lower-left corner of the human face image, there is an icon . It means device that face abstracting in process.

Batch Import

Before the batch import, name the face image according to the rule. After successful import, the system will identify the face image automatically.





Name is required and the rest are optional. For example, if you want to enter the name and ID number only, the naming can be Tim#S#B#N#P#T#M0000#A.jpg or Time#M0000.jpg.

Table 6-6 Naming rules for batch import

Item	Description
Name	Enter the corresponding name.
Gender	Enter number. 1: Male; 2: Female.

Item	Description
Birthday	Enter number in the format of yyyymmdd or yyyy-mm-dd. For example, 20181123.
Region	Enter the corresponding abbreviation of the region.
Province	Enter the corresponding spelling or English name of the province.
ID type	Enter the corresponding number. 1. ID card, 2. Passport, 3. Others.
ID number	Fill in the corresponding ID number.
Address	Enter the detailed address.

1. On the **LIVE** page, click , and then select **FILE > Face Management > Face Database > Remote**.
2. Double-click a face database.
3. Click **Batch Import**.
4. Import face image.
 - Upload a file: Click , select multiple face images, and then click **Open**.



You can select multiple face images by holding Shift and then clicking the first and the last face images, or holding Ctrl and then click the images one by one.

- Upload a folder: Click , select the folder with face images, and then click **Upload**.

Figure 6-26 Batch import

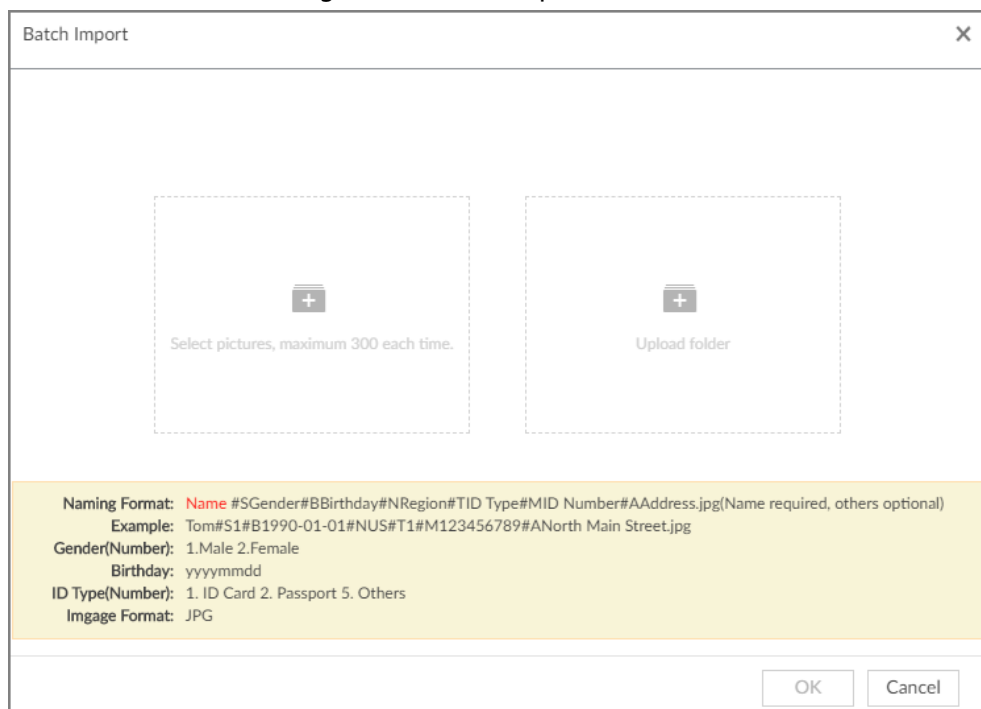

5. Click **OK**.
6. Click **Save and continue to add** or **OK**.
 - Click **Save and Continue to add** to save current face image information and add another human face image.
 - Click **OK** to save current face image information and complete registration.

After adding the image, at the lower-left corner of the human face image, there is an icon . It means device that face abstracting in process.

Bin Import

To import face images from another device into the current device, you can import a bin file of face images exported from that device.

1. On the **LIVE** page, click **+**, and then select **FILE > Face Management > Face Database > Remote**.
2. Double-click a face database.
3. Click **Bin Import**.
4. Enter the file **Path** and **Password**, and then click **OK**.



- The **Password** is the one created when the file was being exported.
- A bin file is divided into multiple parts when being exported if it is larger than 4 GB. When importing the file parts, you just need to select any one part of the file, and then all parts are imported.

Figure 6-27 Import bin files

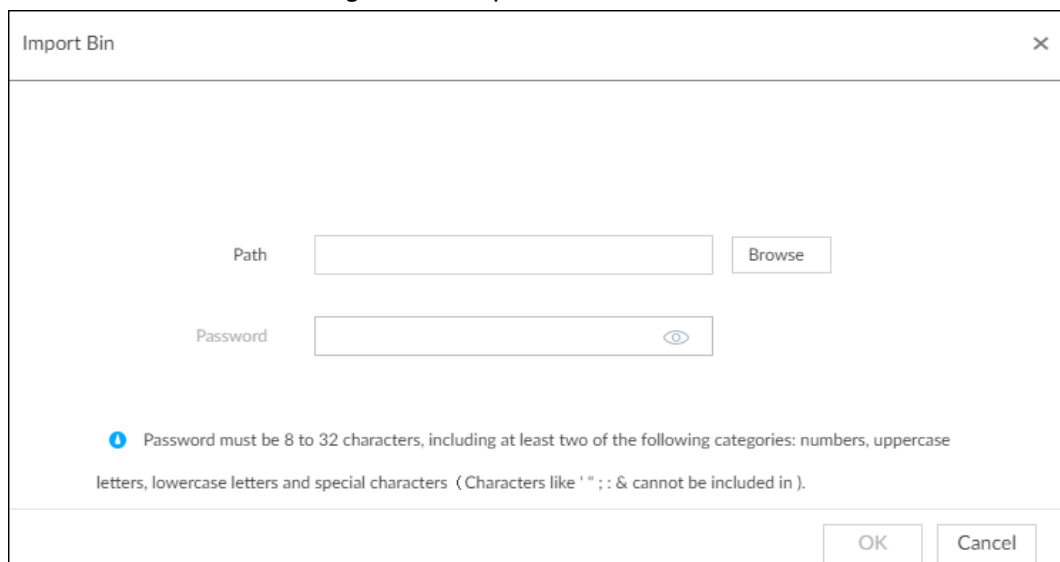

Import Bin

Path Browse

Password 

i Password must be 8 to 32 characters, including at least two of the following categories: numbers, uppercase letters, lowercase letters and special characters (Characters like ' " ; : & cannot be included in).

OK Cancel

5. Click **Save and continue to add** or **OK**.
 - Click **Save and Continue to add** to save current face image information and add another human face image.
 - Click **OK** to save current face image information and complete registration.

6.3.2.4 Configuring Face Recognition (by Camera)

Configure face recognition rules.

- Step 1** Click  or click **+** on the configuration page, and then select **EVENT**.
- Step 2** Select remote device in the device tree on the left.
- Step 3** Select **AI Plan > Face Recognition**.

Figure 6-28 Face recognition (AI by Camera)



Step 4 Click **AI by Camera**, and then click .

Step 5 Click **Deployment Time** to select schedule from the drop-down list.

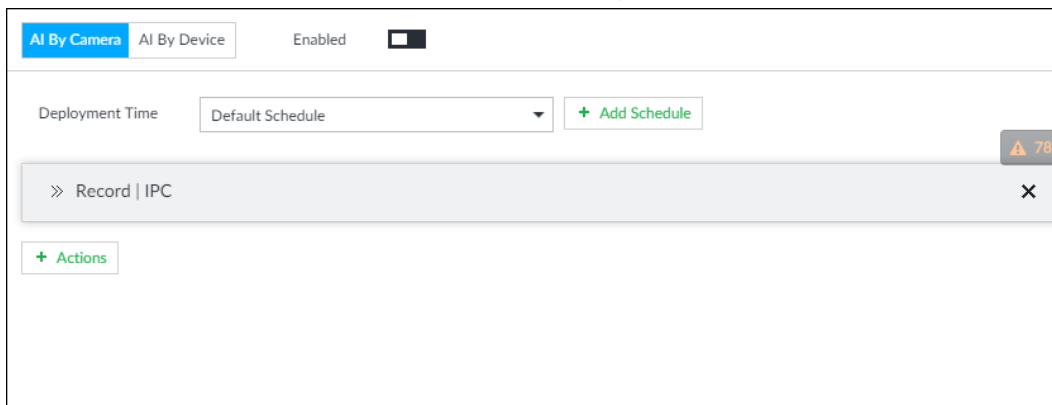
After setting arm period, system triggers actions when there is a motion detection alarm in the specified period.

- Click **View Schedule** to view detailed schedule settings.
- If the schedule is not added or the added schedule does not meet actual needs, click **Add Schedule**. See "8.8.4 Schedule" for detailed information.

Step 6 Click **Actions** to set alarm actions. See "8.4.1 Alarm Actions" for detailed information.



Make sure that you have set face database on the camera.

Step 7 Click **Save**.

6.3.2.5 Live View of Face Recognition

Smart panel display. You can view real-time face detection and human face recognition images.

6.3.2.5.1 Setting AI Display

You can configure display rule of AI detection results.



Before using this function, ensure that view has been created. See "7.1.1 View Management" for detailed information.

Step 1 On the **LIVE** page, open a view window.

Step 2 Click and select the **Face** tab.



- Click **Sync from AI-Dis.**, obtain global smart detection display rule of IVSS. See "8.4.2.4.2 Setting AI Display" for detailed information.
- Click **Apply to all windows**, it is to copy current configuration to other window(s).

Figure 6-29 Face

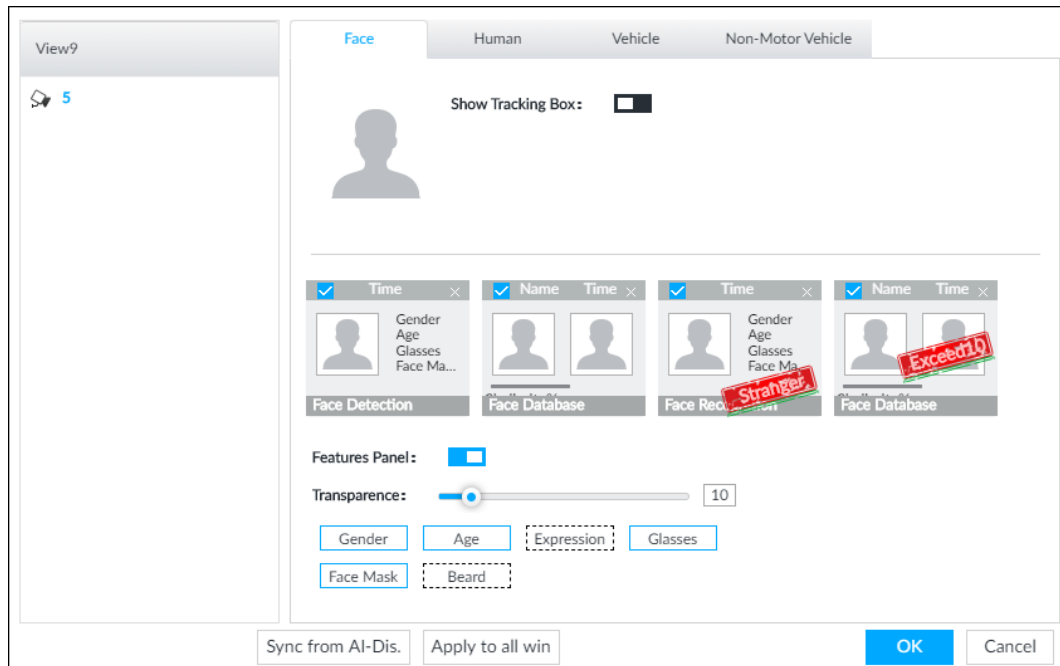

Step 3 Enable **Show Tracking Box**.

After it is enabled, when the system detects face or human, the window will display corresponding rule box.

Step 4 Enable features panel.

- 1) Click next to **Features Panel**, to enable the function. When the panel is enabled, the snapshots of detected faces are displayed on the live view.
- 2) Click to select **Face Database**, **Stranger** and **Exceed10** tab. indicates that the panel is selected.
 - If the **Face Database** panel is selected, it is displayed on the live video when the similarity between a detected face and one in the face database reaches the threshold.
 - If the **Stranger** panel is selected, it is displayed on the live video when the similarity between a detected face and one in the face database does not reach the threshold.
 - If the **Exceed10** panel is selected, it is displayed on the live video when the similarity between a detected face and one in the face database reaches the threshold and the detected entries reach the defined number.
- 3) (Optional) Drag to adjust features panel transparency. The higher the value, the more transparent the features panel.
- 4) (Optional) Select the features you need to display.
 - System supports displaying 4 feature types.
 - System has checked four features by default. To select other features, cancel the selected features, and then select the ones you need.

Step 5 Click **OK** to save the configuration.

6.3.2.5.2 Live View

Go to the **LIVE** page, enable view, and then device displays view video.

- The view window displays currently detected face rule box.
- The right side displays features panel.

- ◇ During face detection, features panel displays detection time, the detected face image and feature.
- ◇ During face recognition, features panel displays detection time, the detected face image, face image in the database, comparison result and database name. After setting stranger mode, when the detected face image mismatches face image in the database, features panel will have Stranger tag.

Figure 6-30 Live



Point to a features panel, and then the operation icons are displayed.

- Click to add this image to the face database. See "6.8.3.2.3 Adding from Detection Results" for detailed information.
- Click or double-click the detected image, so the system starts to play back the recorded videos (about 10s) at the time of snapshot.
- Click to search for similar faces.

6.3.2.5.3 Face Total

On the **LIVE** page, click . Face detection panel is displayed. Click , and then **Face Recognition** and **Stranger**. The face recognition results are displayed.

Figure 6-31 Detection image (1)

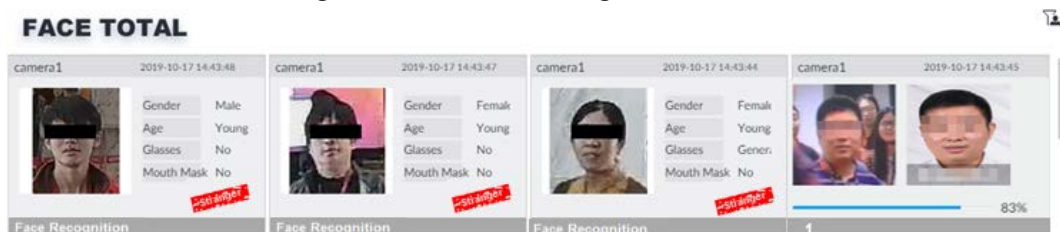

- Add the face image to the created face database.
Point to a piece of face record, and click to add this image to the face database. See "6.3.3.4.3 Adding Face Image" for detailed information.
- Play the detection video.
Point to a piece of face record, and click or double-click the detected image, so the system starts to play back the recorded videos (about 10s) at the time of snapshot.
- Export the record.

Point to a piece of face record, click , and then you can save the record, which contains video and picture.

- Search for similar target.

Point to a piece of face record, click , and then the system automatically searches for the similar faces in the defined period.



When operating on the local device (not from the web or PC client), make sure that you have connected the USB storage device.

6.3.2.6 Face Search

Search for face detection information, including face detection image, record and features. You can search by property or by image, export face records, and analyze similarity of two images.

6.3.2.6.1 Searching by Property

Step 1 On the LIVE page, click , and then select **AI SEARCH > Search by Face > By Property**.

Figure 6-32 Search by property

- Step 2** Select a remote device, and then set **Event Type** to be **Face Recognition**.
- Step 3** Select face mode and set face property and time.
- Step 4** Click **Query**.

Figure 6-33 Search results

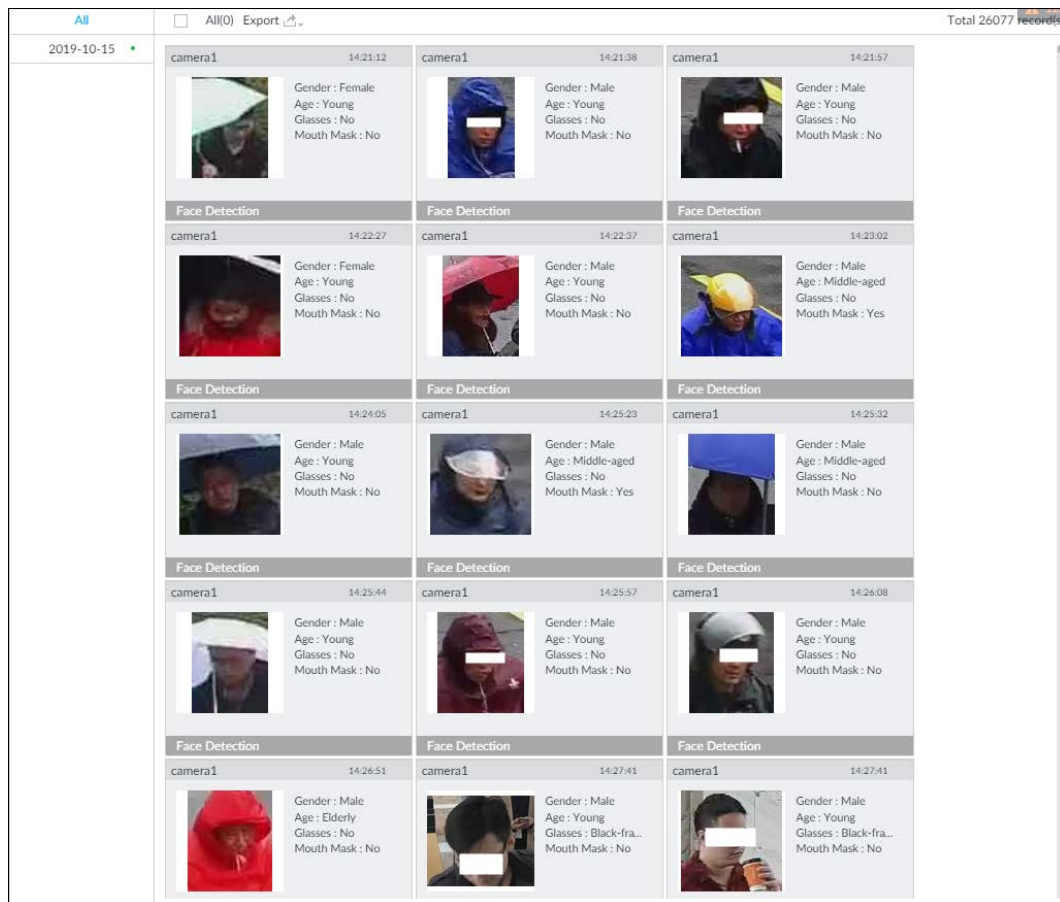

Point to a piece of record, and then the following icons are displayed.

Figure 6-34 Icons

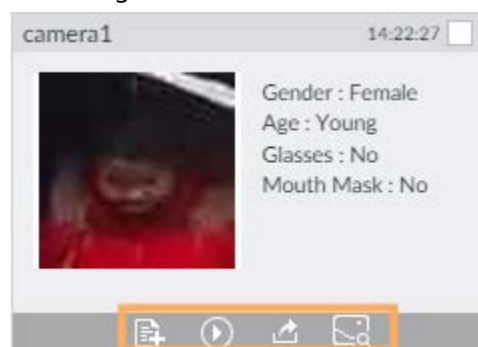









Table 6-7 Description

Icon	Operation
	<ul style="list-style-type: none"> Select one by one: Click the panel or move the mouse pointer onto the panel, and then click <input type="checkbox"/> to select the panel. <input checked="" type="checkbox"/> means it is selected. Batch select: Check All to select all panels on the page.
	Click or double-click the panel, the system starts to play back the recorded videos (about 10s).

Icon	Operation
	Click  to quickly add the image to the face database. See "6.3.3.4.3 Adding Face Image" for detailed information.
	<ul style="list-style-type: none"> Export one by one: Click  to export picture, video and video player. For details, see "6.2.4.3 Exporting Face Records". Export in batches: Select the panel and click  to export picture, video or excel. For details, see "6.2.4.3 Exporting Face Records". <p> After setting alarm linkage snapshot, during exporting images, the system exports detected images and panoramic images at the time of snapshot.</p>
	Click  , and then the system automatically searches all channels for the records of the current face.

6.3.2.6.2 Searching by Property

Search for images by property. For details, see "6.2.4.1 Searching by Property".

6.3.2.6.3 Searching by Image

Upload a face picture to search for the records of the same face. For details, see "6.2.4.2 Searching by Image".

6.3.2.6.4 Exporting Face Records

Export the searched face records, including pictures, videos and detailed information. For details, see "6.2.4.3 Exporting Face Records".

6.3.2.6.5 1:1 Face Recognition

Through 1:1 face recognition, the system analyzes the similarity between two images.

Step 1 On the **LIVE** page, click , and then select **AI SEARCH > 1:1 Face Recognition**.

Figure 6-35 1:1 face recognition

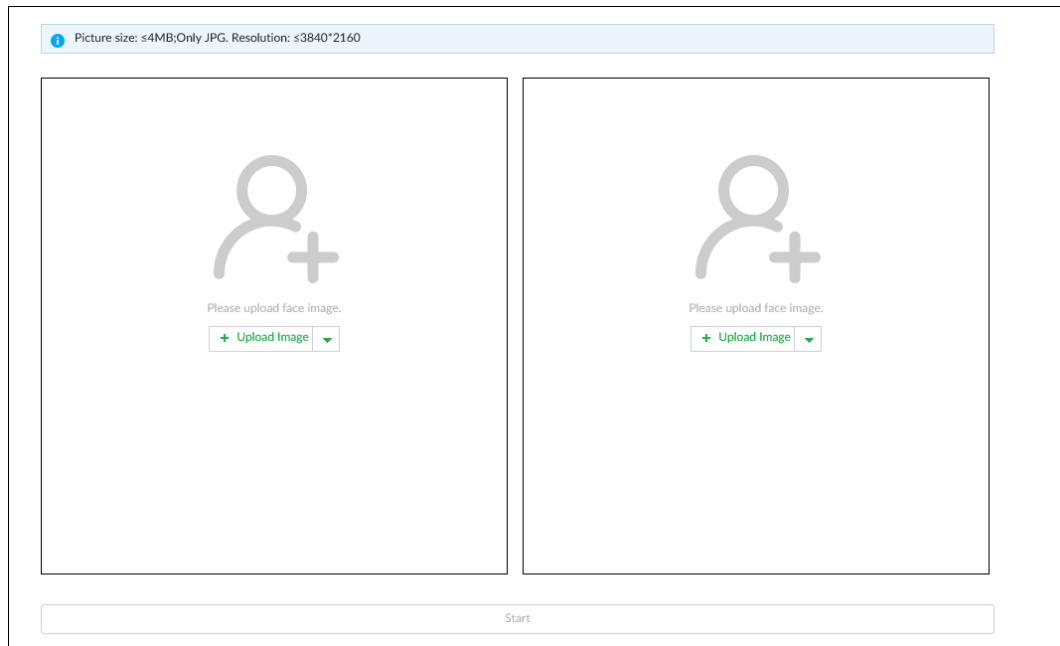

Step 2 Click and then upload two images to be compared.

Step 3 Click **Start**.

The comparison result will be displayed.

6.3.3 Face Detection by Camera + Face Recognition by Device

6.3.3.1 Configuration Procedure

Figure 6-36 Configure face detection (AI by camera)



Figure 6-37 Configure face recognition (AI by device)



6.3.3.2 Enabling AI Plan

To use AI by camera, you need to enable the corresponding AI plan first. For details, see "6.2.1 Enabling AI Plan".

6.3.3.3 Configuring Face Detection (by Camera)

Configure alarm rule of face detection.

Step 1 Click or click on the configuration page, and then select **EVENT**.

Step 2 Select a remote device in the device tree on the left.

Step 3 Select **AI Plan > Face Detection**.

Figure 6-38 AI by camera

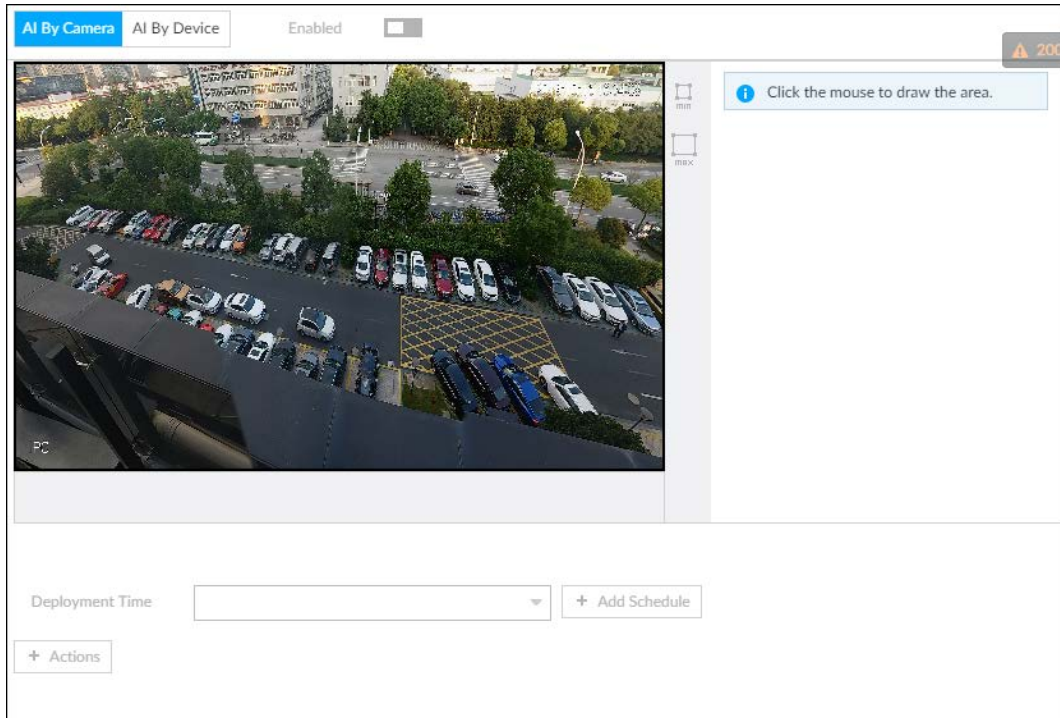

Step 4 Click **AI by camera** , and then click to enable face detection.



AI by camera supports **Face Enhance**function. After enabling **Face Enhance**function, system displays enhanced human face zone on the surveillance window.

Step 5 Set detection area on the video (yellow area).

Figure 6-39 Area



- Click or white dot on detect region frame, and drag to adjust its range.
- Click or to set the minimum size or maximum size of the face detection area.

System triggers an alarm once the size of detected target is between the maximum size and the minimum size.

- Step 6** Click **Deployment Time** to select a schedule from the drop-down list. System triggers corresponding alarm actions only during the alarm deployment period.



You can select an existing schedule from the **Deployment Time** drop-down list. You can also add a new schedule. For details, see "8.8.4 Schedule".

- Step 7** Click **Actions** to set alarm action. See "8.4.1 Alarm Actions" for detailed information.
- Step 8** Click **Save**.

6.3.3.4 Configuring Device Face Database

You can create face databases on the device to manage face images for face recognition (by device).

6.3.3.4.1 Creating Human Face Database

Create human face database to sort out and manage the face images uploaded to the device.

Procedure

- Step 1** On the **LIVE** page, click **+**, and then select **FILE > Face Management > Face Database > Local**.
- Step 2** Click **Create**.

Figure 6-40 Create face database

- Step 3** Set face database name.



- **Number:** The proportion of the number of added face images in the face databases and passerby databases to the allowed face images in total.
- **Space:** The proportion of the space occupied by the face databases and passerby databases to the allowed space in total.

Step 4 Click **Register Face** or **Save and close**.





- Click **Register face**, and then add human face on the newly created human database.
- Click **Save and close** to create a human face database with no data.

Related Operations

- View face database details and status.

Figure 6-41 Face database



- ◇ 1: Face database name. To modify, click .
- ◇ 2: Number of face images in the face database.
- ◇ 3: Number of face images that failed to abstract. For details about face abstracting, see "6.3.3.4.5 Human Face Abstract".
- ◇ 4: Face recognition devices associated to this face database.
- To manage face images, double-click the face database.
- To arm the face database, see "6.3.3.5 Configuring Face Recognition (by Device)".
- To delete face databases:
 - ◇ One by one: Click .
 - ◇ In batches: Hover over the face database, and then select the database by clicking . After selecting multiple databases, click .
 - ◇ Delete all: Select **All**, and then click .
- To clear a face database, select the face database, and then click **Clear**.

6.3.3.4.2 Exporting Face Database

You can export a bin file of face images from the current device into another device so that the face database can be shared among devices. The exported file is encrypted for better security.

Step 1 On **LIVE** page, click , and then select **FILE > Face Management > Face Database > Local**.

Step 2 Select one or more face databases from which you want to export face images, and then click **Bin Export**.

Step 3 Enter the file **Path** and **Password**, and then click **OK**.

- The **Path** is the one where the exported bin file is saved.
- The **Password** is the one used when the file is being imported.



If the bin file being exported is larger than 4 GB, the file is divided into multiple parts, with the first named as device name_database name_exporting time_part1.zip.

6.3.3.4.3 Adding Face Image

Add face images to the created face database in the way of manual add, batch import, bin import or detection.



Make sure that you have obtained the face image and saved it in the proper path.

- When operating on the local interface, save the image in the USB storage device and then connect the USB storage device to the Device.
- When operating on the web or PCAPP interface, save the image on the PC in which the web or PCAPP is located.

Manual Add

You can add human face image one by one. If the registered human face image quantity is small, you can use manual add mode.

1. On **LIVE** page, click **+** and then select **FILE > Face Management > Face Database > Local**.
2. Double-click a face database.
3. Click **Manual Add**.

Figure 6-42 Manual add

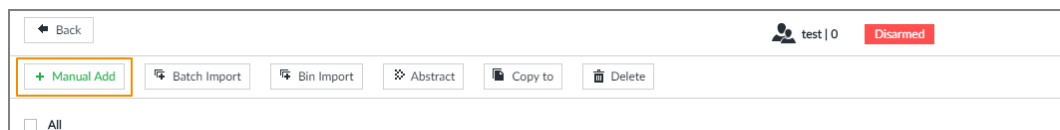

4. Click  and select face image.

Figure 6-43 Face register



- When the uploaded image is half-length photo or full-body photo, the system automatically selects the frame of the uploaded image and only the face area will be retained.
 - When there are multiple faces in the uploaded images, the system automatically identifies the faces in the images and uploads multiple face images according to the number of faces recognized. Select face image you want to upload. Blue frame means that it is selected.
 - Click **Cancel** to cancel all checked face images.
5. Click **OK** and import face image.



Point to the face image and then click **Change Image** to change it.

6. Fill in face image information.

Figure 6-44 Face information

7. Click **Save and continue to add** or **OK**.

- Click **Save and Continue to add** to save current face image information and add another human face image.
- Click **OK** to save current face image information and complete registration.

After adding the image, at the lower-left corner of the human face image, there is an icon . It means device that face abstracting in process.

Batch Import



Before the batch import, name the face image according to the rule. After successful import, the system will identify the face image automatically.



Name is required and the rest are optional. For example, if you want to enter the name and ID number only, the naming can be Tim#S#B#N#P#T#M0000#A.jpg or Time#M0000.jpg.

Table 6-8 Naming rules for batch import

Item	Description
Name	Enter the corresponding name.
Gender	Enter number. 1: Male; 2: Female.
Birthday	Enter number in the format of yyyymmdd or yyyy-mm-dd. For example, 20181123.
Region	Enter the corresponding abbreviation of the region.
Province	Enter the corresponding spelling or English name of the province.
ID type	Enter the corresponding number. 1. ID card, 2. Passport, 3. Others.
ID number	Fill in the corresponding ID number.
Address	Enter the detailed address.

1. On **LIVE** page, click , and then select **FILE > Face Management > Face Database > Local**.
2. Double-click a face database.
3. Click **Batch Import**.
4. Import face image.
 - Upload a file: Click , select multiple face images, and then click **Open**.



You can select multiple face images by holding Shift and then clicking the first and the last face images, or holding Ctrl and then click the images one by one.



- Upload a folder: Click , select the folder with face images, and then click **Upload**.

Figure 6-45 Batch import

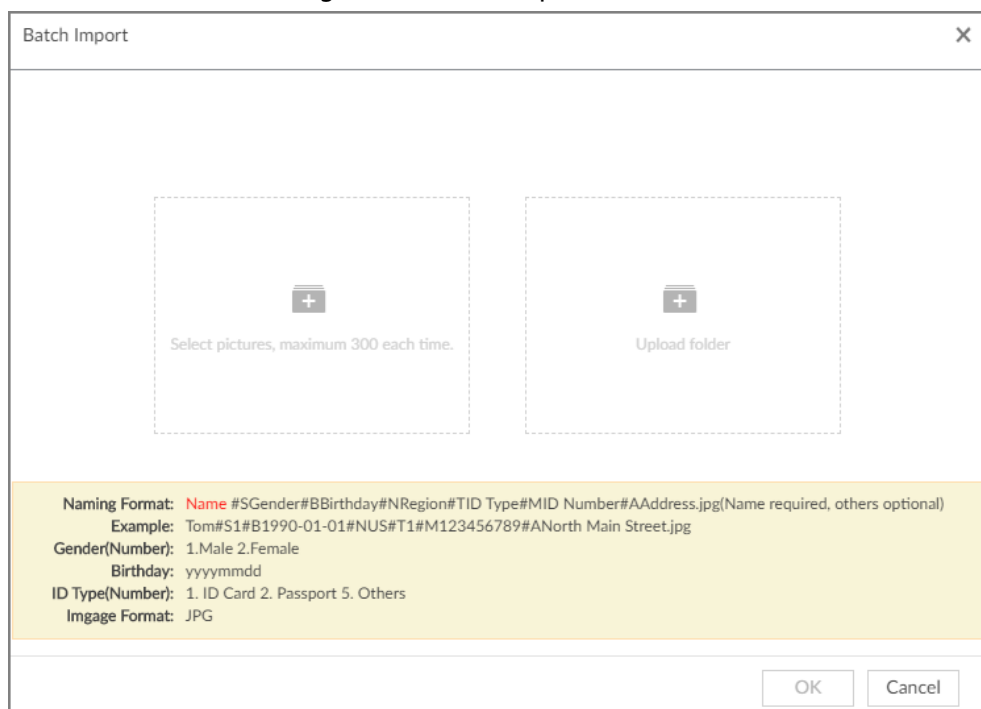

5. Click **OK**.
6. Click **Save and continue to add** or **OK**.
 - Click **Save and Continue to add** to save current face image information and add another human face image.
 - Click **OK** to save current face image information and complete registration.

After adding the image, at the lower-left corner of the human face image, there is an icon . It means device that face abstracting in process.

Bin Import

To import face images from another device into the current device, you can import a bin file of face images exported from that device.

1. On **LIVE** page, click , and then select **FILE > Face Management > Face Database > Local**.
2. Double-click a face database.
3. Click **Bin Import**.
4. Enter the file **Path** and **Password**, and then click **OK**.



- The **Password** is the one created when the file was being exported.

- A bin file is divided into multiple parts when being exported if it is larger than 4 GB. When importing the file parts, you just need to select any one part of the file, and then all parts are imported.

Figure 6-46 Import bin files

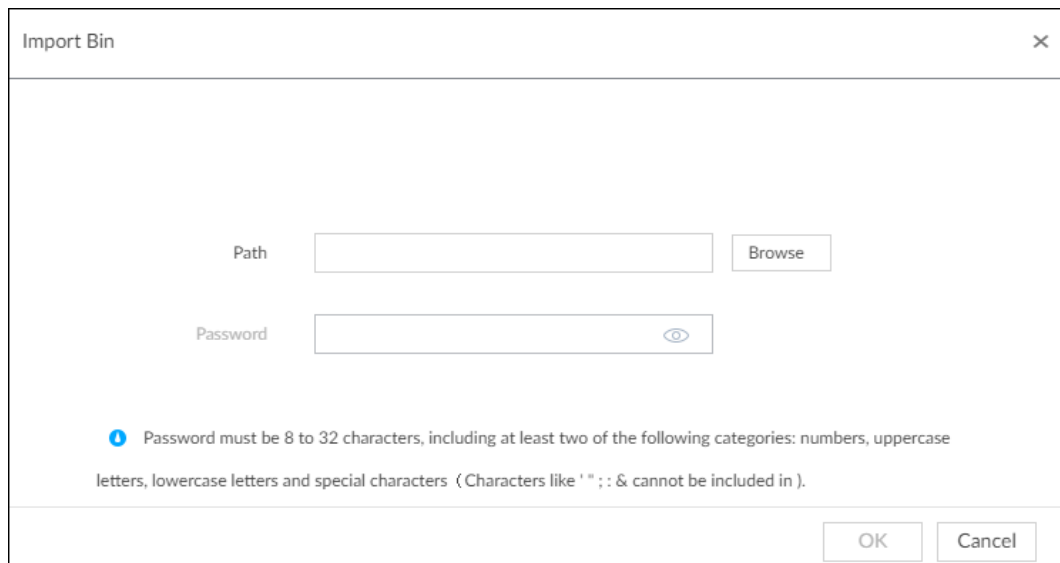

5. Click **Save and continue to add** or **OK**.
 - Click **Save and Continue to add** to save current face image information and add another human face image.
 - Click **OK** to save current face image information and complete registration.

Adding from Detection Snapshots

Add the snapshot of AI detection to the created face database.

1. Select face images on the **LIVE** page.

The following two ways are available.



- Point to a face snapshot in the refreshing snapshot list on the right of the live video, and then click .
- Click  64841, point to a face snapshot, and then click .

Figure 6-47 Face register

2. Select a face database, and fill in person information according to your actual situation.
3. Click **OK** to save the configuration.

6.3.3.4.4 Creating Passerby Database

If you configure an alarm to link passerby database, when the detected face is not in the face database, system automatically captures the face image, and then save it to the passerby database.

Procedure

- Step 1** On the **LIVE** page, click **+**, and then select **FILE > Face Management > Face Database > PasserBy Database**.
- Step 2** Click **Create Passerby Database**.

Figure 6-48 Passerby database



- **Number:** The proportion of the number of added face images in the face databases and passerby databases to the allowed face images in total.
- **Space:** The proportion of the space occupied by the face databases and passerby

databases to the allowed space in total.

Step 3 Enter the passerby database information, and then click **OK**.

Figure 6-49 Create a passerby database

Table 6-9 Parameters of creating passerby database

Parameter	Description
Name	Enter the name of the database.
Number of Images	Configure how many face images the database can store. <ul style="list-style-type: none"> Maximum = Total number of face images of the Device - the face image number of the current staff databases - the face image number of the current passerby databases. Minimum: 10,000.
Face Angle	Set the allowed pitch angle and yaw angle of the face image. The value ranges from 0 through 45 degrees. The smaller the angle, the more accurate the face image.
Quality	Only face images within the allowed quality range (1 to 100) can be added.
Storage Full	The storage strategy when storage space is used up. <ul style="list-style-type: none"> Stop: No more images can be added. Overwrite: The newest images overwrite the oldest images. Back up the old images as necessary.





Parameter	Description
Remove Duplicate Faces	<p>When the captured face image is found in the passerby database, and the quality is higher than that of the one in the database, the system replaces the face image in the database. A successful comparison of the captured image against the database will not be reported.</p> <ul style="list-style-type: none"> • Always: Always remove duplicate face images. • By Interval: Remove duplicate face images by interval to control comparison pressure. • By Duration: Within the defined time period, if a captured face image is found in the passerby database, the system replaces the image in the database with the new one.

Related Operations

- View face database details and status.

Figure 6-50 Face database



- ◇ 1: Face database name. To modify, click .
- ◇ 2: Number of face images in the face database.
- ◇ 3: Number of face images that failed to abstract. For details about face abstracting, see "6.3.3.4.5 Human Face Abstract".
- ◇ 4: Face recognition devices associated to this face database.
- To manage face images, double-click the face database.
- To arm the face database, see "6.3.3.5 Configuring Face Recognition (by Device)".
- To delete face databases:
 - ◇ One by one: Click .
 - ◇ In batches: Hover over the face database, and then select the database by clicking . After selecting multiple databases, click .
 - ◇ Delete all: Select **All**, and then click .
- To clear a face database, select the face database, and then click **Clear**.

6.3.3.4.5 Human Face Abstract

The human face abstracting is to abstract the corresponding information of the face image and import to the database. After that, device can compare human face, and search for human face.



- The greater the face image quantity is, the longer the face abstracting time it takes.

- During the abstracting process, some intelligent functions (such as human face recognition, search human face and so on.) are null. These functions become normal after the abstracting process is completed.

Step 1 On the **LIVE** page, click , and then select **FILE > Face Management > Face Database**.

Step 2 Double-click a face database.

Step 3 Select face images and then click **Abstract**.



- Select **All** to select all face images on current human face database.
- If there are too many human face images on the human face database, click  to set search criteria (such as name, gender, birthday, country, province, ID type, ID number or abstracting status) to quickly find the human face images.

Step 4 Click **Start Abstract**.

Device begins processing face information.

The abstracting is successful if  is no longer at the lower-left corner of the face image.



The abstracting might fail if the face image is not clear or does not contain complete information, and  appears at the lower-left corner of the face image.

Figure 6-51 Abstract result

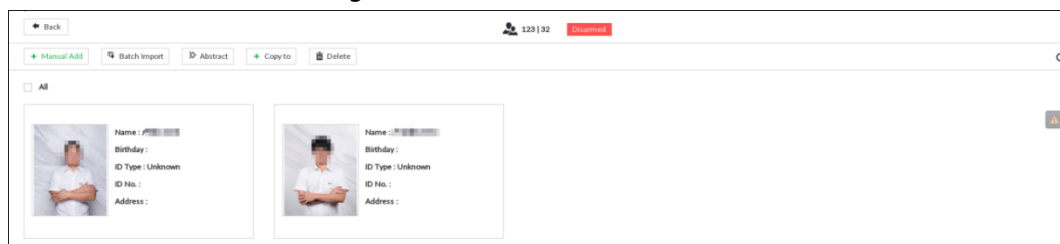

6.3.3.4.6 Managing Face Pictures

Maintain and manage face images in the face database to ensure that people information is always correct. The system supports editing face picture information, copying face pictures to other face database and deleting face pictures.

On the **LIVE** page, click , and then select **FILE > Face Management > Face Database**. Double-click a face database, the face pictures in the database are displayed.

Editing Face Pictures

1. In the face database, point to a face picture, and then click .
2. After editing, click **OK**.

Copying Face Pictures

1. In the face database, point to a face picture, and then click to select the face picture.



- You can select more than one pictures.
 - To select all pictures, click **All**.
2. Click **Copy to**.

Figure 6-52 Copy to

3. Select a face database.



- You can select more than one face databases.
- You can also select a face database by entering the database name in the **Face database** name box and clicking **Query**.
- Select the checkbox of **Retain Original Face** to keep the original face pictures in the database. It is selected by default.

4. Click **OK**.

Deleting Face Pictures

Two ways are available to delete face pictures in the face database.

- One by one: Point to the face picture, and then click .
- In batches:
 - ◇ Point to the face picture, and then click . By the same way, select more pictures, and then click **Delete**. The selected face pictures are deleted.
 - ◇ Click **All**, and then click **Delete**. All the face pictures in this page are deleted.

6.3.3.5 Configuring Face Recognition (by Device)

Configure face recognition rules.

To use AI by device, enable face detection first. For details, see "6.2.2 Configuring Face Detection".

Step 1 Click or click on the configuration page, and then select **EVENT**.

Step 2 Select remote device in the device tree on the left.

Step 3 Select **AI Plan** > **Face Recognition**.

Figure 6-53 Face recognition (AI by Device)

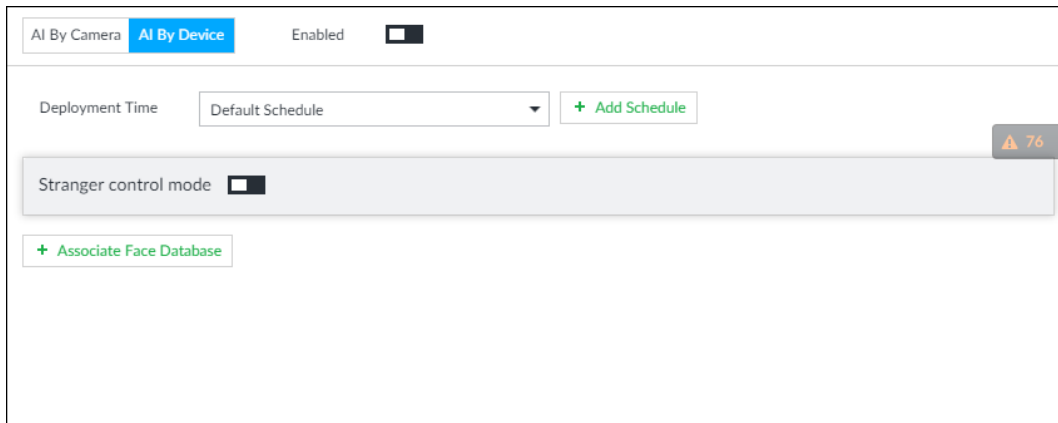

Step 4 Click **AI by Device**, and then click .

Step 5 Click **Deployment Time** to select schedule from the drop-down list.

After setting arm period, system triggers actions when there is a motion detection alarm in the specified period.

- Click **View Schedule** to view detailed schedule settings.
- If the schedule is not added or the added schedule does not meet actual needs, click **Add Schedule**. See "8.8.4 Schedule" for detailed information.

Step 6 Set stranger mode.

Enable stranger mode. Once the face recognition similarity is lower than the specified value, system triggers an alarm.

1) Click to enable stranger mode.

Figure 6-54 Stranger control mode



2) Set parameters.

Table 6-10 Stranger control mode description

Parameters	Description
AI alarm rule	Click  to set alarm rule box color.
Show feature panel	Click <input type="checkbox"/> to enable features panel function. System displays stranger panel once there is an alarm.

3) Click **Actions** to set alarm actions. See "8.4.1 Alarm Actions" for detailed information.

Step 7 Set linked face database.



Repeat the step to trigger several human databases at the same time.

1) Click **Associate Face database**, and then select the triggered human face database.

Figure 6-55 Face database configuration

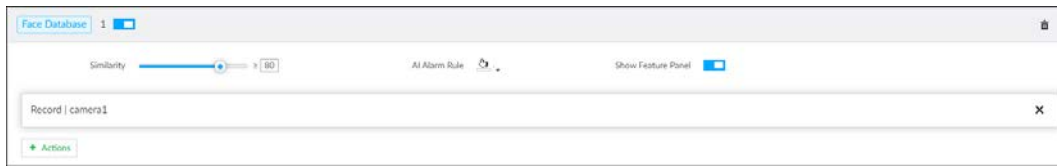

2) Click to enable association with the database and then set parameters.

Table 6-11 Configuration description

Parameters	Description
	Delete the associated database.
Similarity	It is to set human face similarity. System compares the human face with the image on the face database. System triggers an alarm once the similarity reaches the threshold you set here.
AI alarm rule	Click to set alarm rule box color.
Show feature panel	Click <input type="checkbox"/> to enable features panel function. System displays features panel once there is an alarm.

3) Click **Actions** to set alarm actions. See "8.4.1 Alarm Actions" for detailed information.

Step 8 Set linked passerby database.



- You can link passerby database only when AI by device is used.
- One device can be linked with only one passerby database.

1) Click **Associate Face database**, and then select a passerby database.

2) Set parameters.

3) Click **Actions** to set alarm actions. See "8.4.1 Alarm Actions" for detailed information.

Step 9 Click **Save**.

6.3.3.6 Live View

Smart panel display. You can view real-time face detection and human face recognition images. For details, see "6.3.2.5 Live View of Face Recognition".

6.3.3.7 Face Search

Search for face detection information, including face detection image, record and features. You can search by property or by image, export face records, and analyze similarity of two images. For details, see "6.3.2.6 Face Search".

6.3.4 Face Recognition by Camera + Face Recognition by Device

6.3.4.1 Configuration procedure

Figure 6-56 Configure face recognition (AI by camera)



Figure 6-57 Configure face recognition (AI by device)

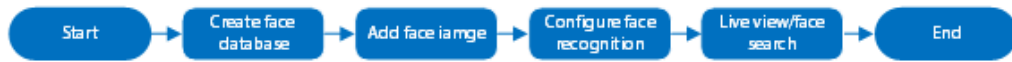

6.3.4.2 Enabling AI Plan

To use AI by camera, you need to enable the corresponding AI plan first. For details, see "6.2.1 Enabling AI Plan".

6.3.4.3 Configuring Face Recognition (by Camera)

Configure face recognition rules. For details, see "6.3.2.4 Configuring Face Recognition (by Camera)".

6.3.4.4 Configuring Device Face Database

You can create face databases on the device to manage face images for face recognition (by device). For details, see "6.3.3.4 Configuring Device Face Database".

6.3.4.5 Configuring Face Recognition (by Device)

Configure face recognition rules. For details, see "6.3.3.5 Configuring Face Recognition (by Device)".

6.3.4.6 Live View

Smart panel display. You can view real-time face detection and human face recognition images. For details, see "6.3.2.5 Live View of Face Recognition".

6.3.4.7 Face Search

Search for face detection information, including face detection image, record and features. You can search by property or by image, export face records, and analyze similarity of two images. For details, see "6.3.2.6 Face Search".

6.3.5 Face Detection by Device + Face Recognition by Device

6.3.5.1 Configuration Procedure

Figure 6-58 Configure face detection (AI by device)



Figure 6-59 Configure face recognition (AI by device)



6.3.5.2 Configuring Face Detection (by Device)

Configure alarm rule of face detection.



- Step 1** Click  or click  on the configuration page, and then select **EVENT**.
- Step 2** Select a remote device in the device tree on the left.
- Step 3** Select **AI Plan > Face Detection**.

Figure 6-60 AI by device



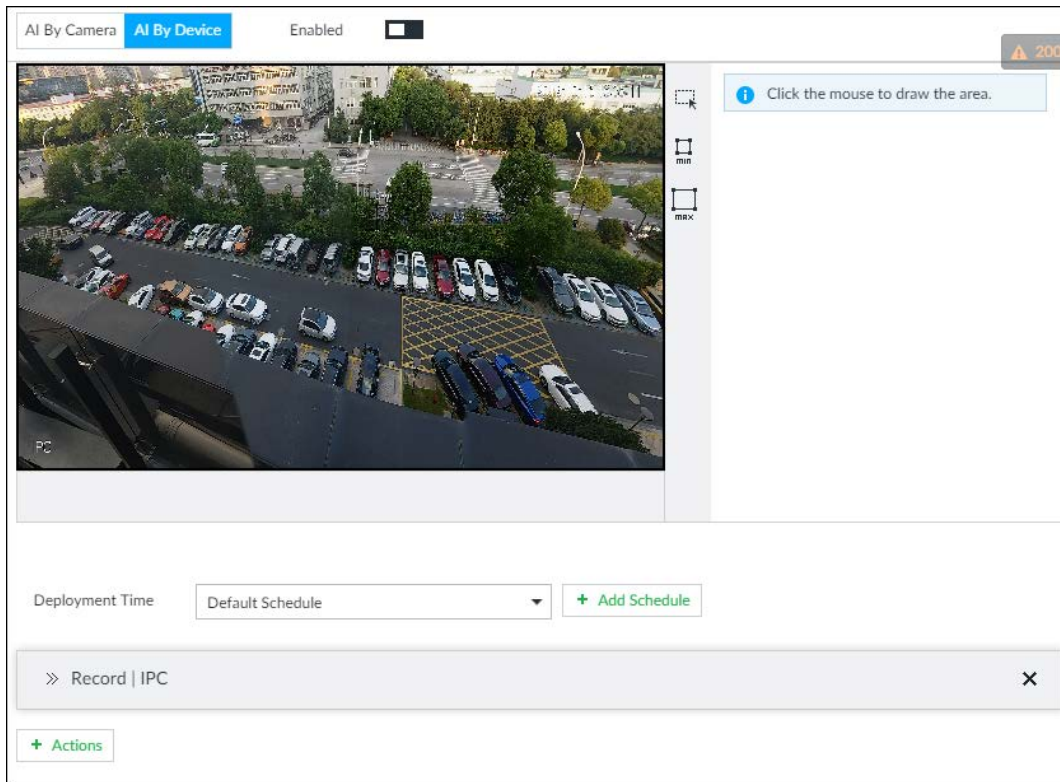

- Step 4** Click **AI by device**, and then click  to enable face detection.
- Step 5** Set detection area on the video (yellow area).

Figure 6-61 Area



- Click  or white dot on detect region frame, and drag to adjust its range.

- Click  or  to set the minimum size or maximum size of the face detection area. System triggers an alarm once the size of detected target is between the maximum size and the minimum size.

Step 6 Click **Deployment Time** to select a schedule from the drop-down list. System triggers corresponding alarm actions only during the alarm deployment period.



You can select an existing schedule from the **Deployment Time** drop-down list. You can also add a new schedule. For details, see "8.8.4 Schedule".

Step 7 Click **Action** to set alarm action. See "8.4.1 Alarm Actions" for detailed information.

Step 8 Click **Save**.

6.3.5.3 Configuring Device Face Database

You can create face databases on the device to manage face images for face recognition (by device). For details, see "6.3.3.4 Configuring Device Face Database".

6.3.5.4 Configuring Face Recognition (by Device)

Configure face recognition rules. For details, see "6.3.3.5 Configuring Face Recognition (by Device)".

6.3.5.5 Live View

Smart panel display. You can view real-time face detection and human face recognition images. For details, see "6.3.2.5 Live View of Face Recognition".

6.3.5.6 Face Search

Search for face detection information, including face detection image, record and features. You can search by property or by image, export face records, and analyze similarity of two images. For details, see "6.3.2.6 Face Search".

6.3.6 Video Metadata + Face Recognition by Device



For scenes that prioritize the accuracy of face recognition, we recommend the combination of face detection and face recognition. Video metadata is not an ideal option for face recognition in such scenes.

6.3.6.1 Configuration Procedure

Figure 6-62 Configure video metadata (AI by camera)

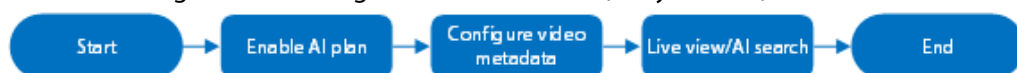

Figure 6-63 Configure video metadata (AI by device)



Figure 6-64 Configure face recognition (AI by device)



6.3.6.2 Enabling AI Plan

Enable AI plan when AI by camera is used. See "6.2.1 Enabling AI Plan" to enable video metadata function.

6.3.6.3 Configuring Video Metadata

The Device supports metadata by camera (AI by Camera on the page) or by the Device (AI by Device on the page). For details about the configuration operation, see "6.5.2 Configuring Video Metadata".

6.3.6.4 Configuring Face Recognition (by Device)

Configure face recognition rules. For details, see "6.3.3.5 Configuring Face Recognition (by Device)".

6.3.6.5 Live View

Smart panel display. You can view real-time face detection and human face recognition images. For details, see "6.3.2.5 Live View of Face Recognition".

6.3.6.6 Face Search

Search for face detection information, including face detection image, record and features. You can search by property or by image, export face records, and analyze similarity of two images. For details, see "6.3.2.6 Face Search".

6.4 People Counting

This section introduces the statistics of in-area people number, and queuing number.



- The people counting function is only available with AI by camera. Make sure that the camera has been configured with people counting rules.
- The old people counting data will be overwritten when the storage space runs out. You are recommended to back up the data in time.

6.4.1 Enabling AI Plan

To use AI by camera, you need first enable the corresponding AI plan; otherwise the AI function does not work. For details, see "6.2.1 Enabling AI Plan".

6.4.2 Configuring People Counting

The system counts the number of people in and out of the detection area. When the number of entry, exit or stay is larger or smaller than the threshold, an alarm is triggered.

Step 1 Click click , and then select **EVENT**.

Step 2 Select a camera in the device tree, and then select **AI Application > People Counting > People Counting**.

Step 3 Click **Add Rule**, select **People Counting**, and then click to enable the function.

Step 4 Draw a people counting area.

- Click to draw the detection area.
- Click to draw the detection line.
- Click to set the whole image as the detection area.

Step 5 Set parameters.

Figure 6-65 People counting

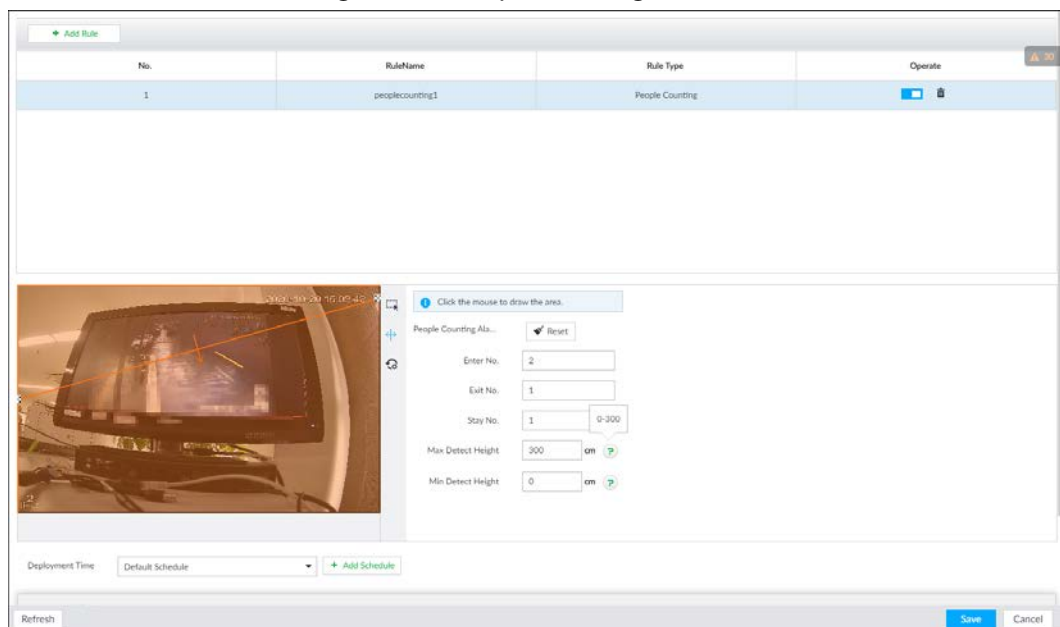

Table 6-12 Parameter description of people counting

Parameters	Description
People Counting Alarm	Click Reset to reset the numbers of entry and exit.
Enter No.	Number of people that entered.
Exit No.	Number of people that exited.
Stay No.	The number of stay is the result of entry number minus exit number. Alarm is triggered when the stay number reaches the threshold.
Max Detect Height	0–300.
Min Detect Height	0–300.

Step 6 Select a schedule in the **Deployment Time** drop-down list.

Alarms are triggered only within the scheduled time.

Step 7 Click **Actions** to set alarm linkage actions. See "8.4.1 Alarm Actions" for detailed information.

Step 8 Click **Save**.

6.4.3 Configuring In Area No.

The system counts the number of people in and out of the detection area. When the number of entry or exit is larger or smaller than the threshold or when the dwell time of any person in the area is greater than the threshold, an alarm is triggered.

Step 1 Click , click , and then select **EVENT**.

Step 2 Select a camera in the device tree, and then select **AI Application > People Counting > People Counting**.

Step 3 Click **Add Rule**, select **In Area No.**, and then click  to enable the function.

Step 4 Draw a detection area.







- Click  to draw the detection area.
- Click  to set the whole image as the detection area.

Figure 6-66 In Area No.

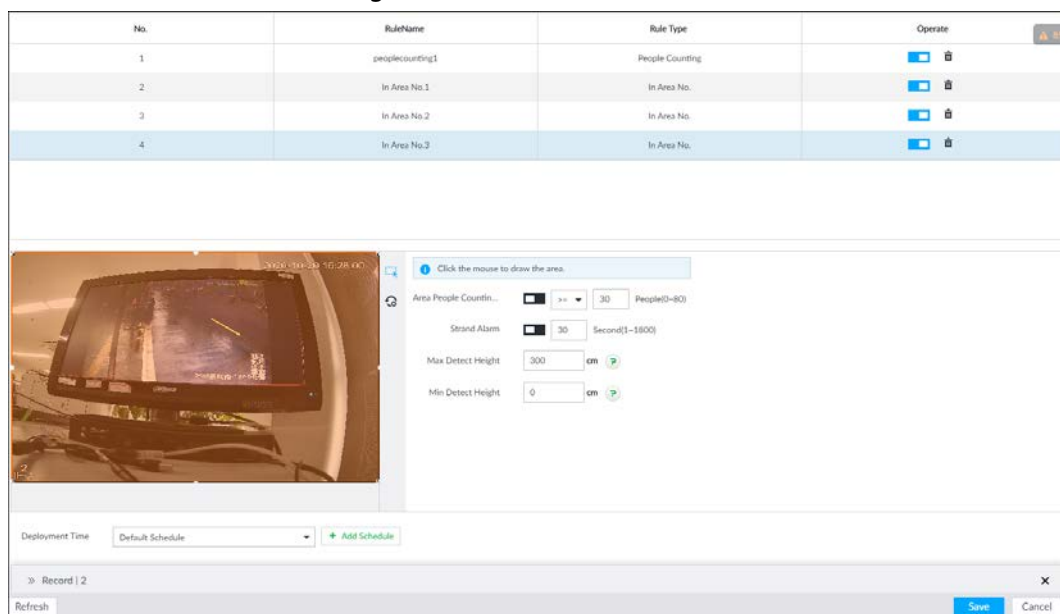

Step 5 Set parameters.

Table 6-13 Parameter description of In Area No.

Parameters	Description
Area People Counting Alarm	<ol style="list-style-type: none"> 1. Click  to enable the alarm. 2. Set people number threshold. <ul style="list-style-type: none"> • If you select  and then enter a number, alarm is triggered when the detected number is larger or equal to the number that you entered. • If you select  and then enter a number, alarm is triggered when the detected number is smaller or equal to the number that you entered.
Strand Alarm	<ol style="list-style-type: none"> 1. Click  to enable the alarm. 2. Set time threshold for the alarm. When the dwell time of any person in the area is greater than the threshold, an alarm will be triggered.

Parameters	Description
Max Detect Height	0–300.
Min Detect Height	0–300.

Step 6 Select a schedule in the **Deployment Time** drop-down list.

Alarms are triggered only within the scheduled time.

Step 7 Click **Actions** to set alarm linkage actions.

Step 8 Click **Save**.

6.4.4 Configuring Queuing Detection

The system counts the number of people queuing in the detection area. When the number of people exceeds the threshold or the queue time is longer than the pre-defined time, an alarm is triggered.

Step 1 Click click and then select **EVENT**.

Step 2 Select a camera in the device tree, and then select **AI Application > People Counting > Queuing**.

Step 3 Draw a queuing detection area.

1) Click to draw the first detection area.

Click to draw more areas. You can draw 4 areas at most.

2) Click to edit the area.

Figure 6-67 Queuing

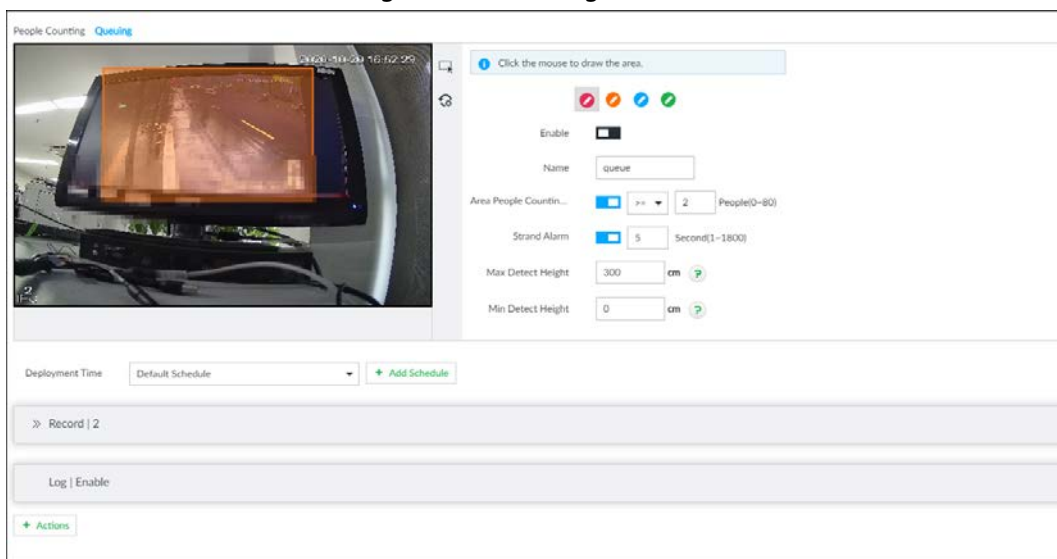

Step 4 Set parameters.

Table 6-14 Parameter description of queuing detection

Parameters	Description
Enable	Click to enable the selected area.
Name	Enter the area name.

Parameters	Description
Area People Counting Alarm	<ol style="list-style-type: none"> 1. Click <input type="checkbox"/> to enable the alarm. 2. Set people number threshold. <ul style="list-style-type: none"> • If you select <input type="text" value=">="/> and then enter a number, alarm is triggered when the detected number is larger or equal to the number that you entered. • If you select <input type="text" value="<="/> and then enter a number, alarm is triggered when the detected number is smaller or equal to the number that you entered.
Queuing Time Alarm	<ol style="list-style-type: none"> 1. Click <input type="checkbox"/> to enable the alarm. 2. Set time threshold for the alarm. When the queuing time of any person in the area is longer than the threshold, an alarm will be triggered.

Step 5 Select a schedule in the **Deployment Time** drop-down list.

Alarms are triggered only within the scheduled time.

Step 6 Click **Actions** to set alarm linkage actions.

Step 7 Click **Save**.

6.4.5 Live View

On the **LIVE** page, open a view window that contains people counting video.

The live video which shows real-time people number and queuing time is displayed.

Figure 6-68 Live view

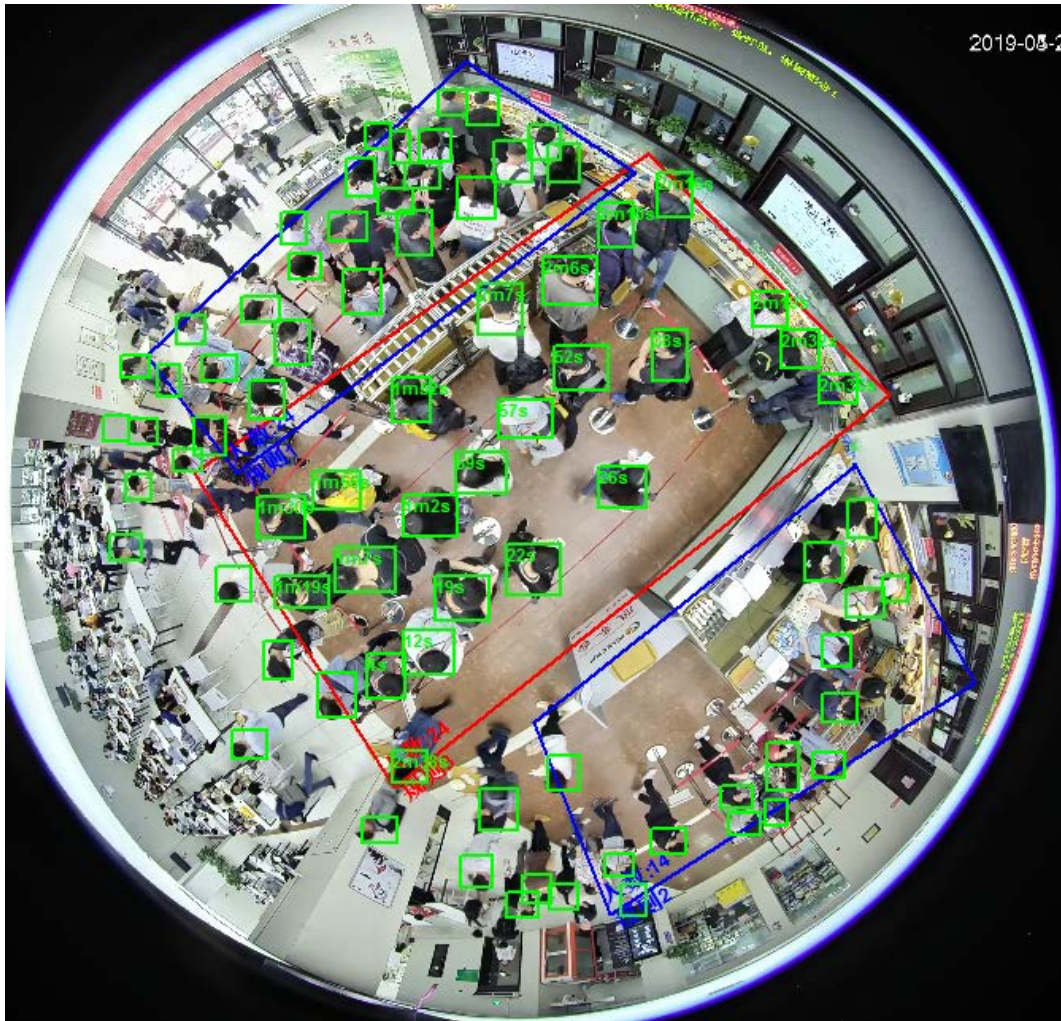

The live video displays real-time people number in the region, and the region frame flashes red once there is an alarm. The queue-detection live view also shows head frames and the dwell time of each person.

6.4.6 Viewing AI Report

Procedure

- Step 1** On the **LIVE** page, click **+**, and then select **AI REPORT > AI REPORT > People Counting**.
- Step 2** Select a device to be searched. You can only select AI fisheye camera.
- Step 3** For **Type**, select **People Counting**, **In Area People Counting** or.
- Step 4** Select a statistics type.
 - **People counting**: Select **People Counting**, and then select the strand time (5 s, 30 s, 60 s).
 - **Average strand time**: The report shows the average strand time during different time periods.
- Step 5** Select a time period type from **Daily**, **Monthly**, and **Yearly**, and then set the corresponding date, month or year.
- Step 6** Click **OK**. The report is displayed.

Figure 6-69 People counting report

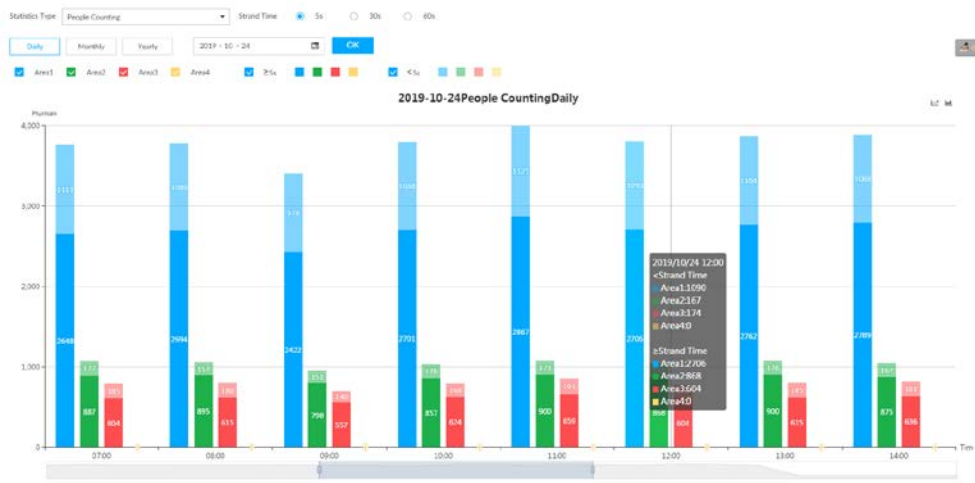





Figure 6-70 Average strand time report



Figure 6-71 Queuing people counting report



- Click Area1 Area2 Area3 Area4 to select the areas of which you need to view the reports. The ordinate of the report displays different areas in different colors, showing the number of people in different areas or the average strand time.
- For people counting report, click Strand Time 5s 30s 60s to select a strand time. The report shows the people numbers of which the strand time is greater or less than the selected strand time.

- Point to the report, and then the report shows the details at that time point.
- Drag the gray scroll bar under the ordinate to view the statistics for different time periods.
- Click  to view the line chart.
- Click  to view the bar chart.
- Click  to export the report.

6.5 Video Metadata

The system analyzes real-time video stream to detect the existence of 4 target types: human, human face, motor vehicle, non-motor vehicle. Once a target is detected, the system can record video, take snapshots and trigger alarms.

This section introduces how to configure the video metadata feature from enabling it and selecting target types to setting the live view of video metadata.

6.5.1 Enabling AI Plan

Enable AI plan when AI by camera is used. See "6.2.1 Enabling AI Plan" to enable video metadata function.

6.5.2 Configuring Video Metadata

After enabling video metadata, the Device links the current remote device to record video when alarm is triggered.



- The Device supports metadata by camera (AI by Camera on the page) or by the Device (AI by Device on the page). This section uses metadata by the Device for example to introduce the configuration procedure.
- Video metadata cannot be enabled at the same time with face detection and IVS, because it conflicts with the two functions.

Step 1 Click  or  and then select **EVENT**.

Step 2 Select a device from the device tree at the left side.

Step 3 Select **AI Application > Video Metadata > AI by Device**.

Figure 6-72 AI by camera

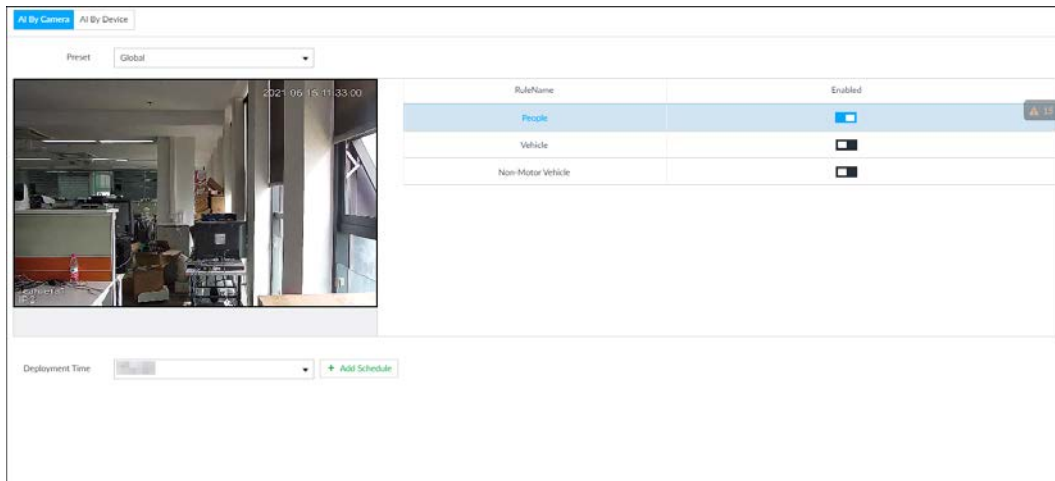
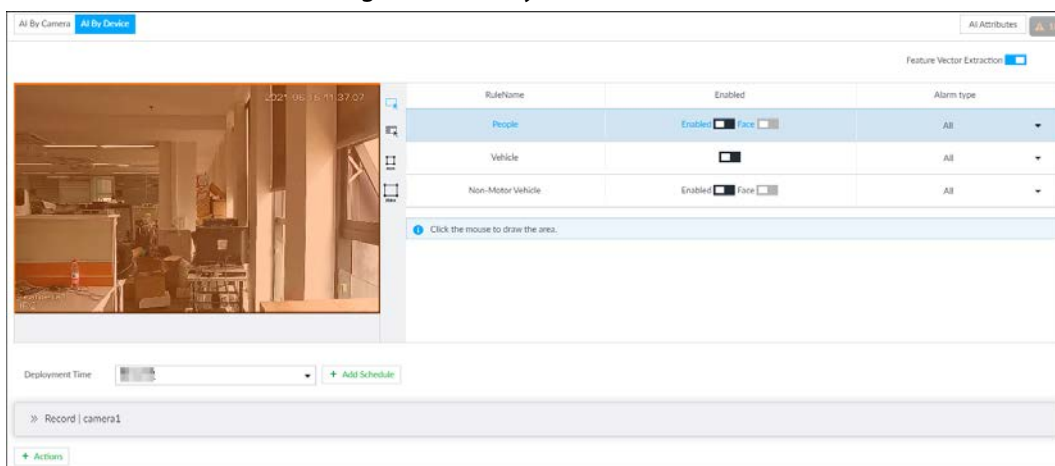

Figure 6-73 AI by device







- Step 4** Click next to **Feature Vector Extraction** to enable feature extraction, and then the Device can extract features of human, vehicles and non-motor vehicles and display them on the live view. The search by image function is available only when feature vector extraction is enabled.
- Step 5** Select the detection target.
- People: Click next to **Enabled** to enable people detection. Face detection can also be enabled at the same time.
 - Vehicle: Click corresponding to enable vehicle detection.
 - Non-Motor Vehicle: Click corresponding to enable non-motor vehicle detection.
- Step 6** Select alarm type.
- All: An alarm is triggered when a target is detected.
 - Match Attributes Alarm: An alarm is triggered when the detected target matches the defined attributes.
 - Mismatch Attributes Alarm: An alarm is triggered when the detected target does not match the defined attributes.



You can select alarm type only when AI by device is used.

- Step 7** Click (the icon changes to) , and then you can configure detection area (orange) in the video image.
- Click any white dot on the frame, and the dot changes to .

- Drag  to adjust the detection area.
- Click  to draw an excluded area which will not be detected. The Device does not detect target within the excluded area.
- Click  or  to set the minimum size or maximum size of the face detection area. System triggers an alarm once the size of detected target is between the maximum size and the minimum size.



You can configure detection area only when AI by device is used.

Figure 6-74 Detection area

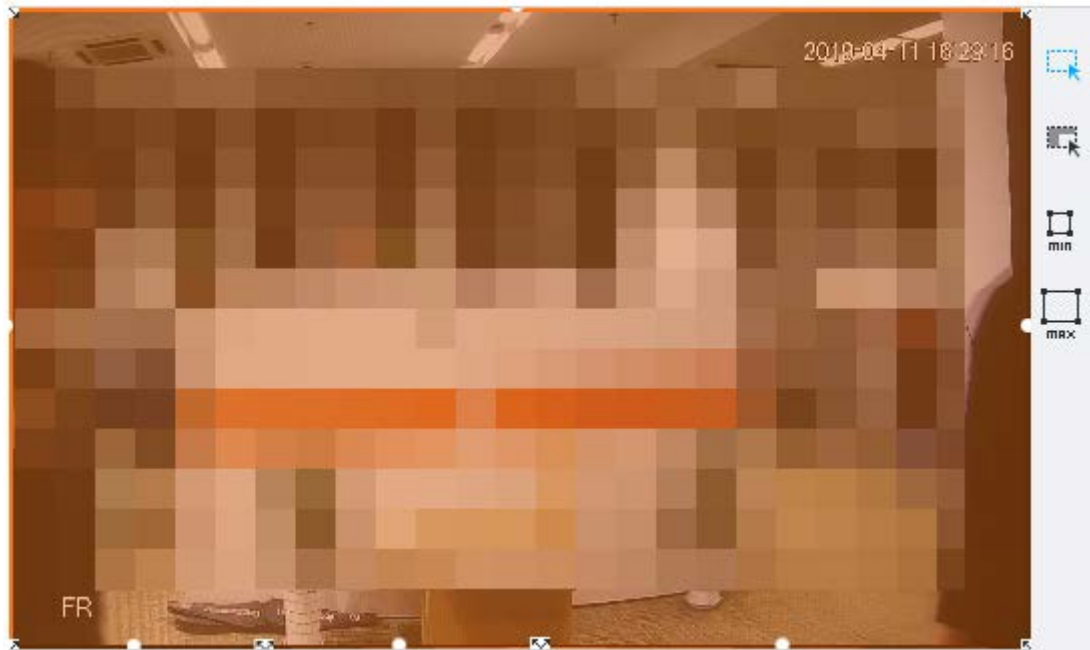

- Step 8** Click **Deployment Time** drop-down list to select schedule.
The Device links alarm event when an alarm is triggered within the schedule configured.
- Click **Add Schedule** to add new schedule if no schedule is added or the existing schedule does not meet requirements. For details, see "8.8.4 Schedule".
 - Click **View Schedule** to view details of schedule.
- Step 9** Click **Actions** to set alarm linkage actions. See "8.4.1 Alarm Actions" for detailed information.



You can set alarm linkage actions only when AI by device is used.

- Step 10** Click **Save**.

6.5.3 Live View of Video Metadata

View the detection results of face, people, motor vehicle and non-motor vehicle on the **LIVE** page.

6.5.3.1 Setting AI Display

Set the filtering conditions to display AI detection results.



Create view(s) before setting filtering conditions. To create a view, see "7.1.1 View Management".

Step 1 Select a view from **LIVE > View > View Group**.

Step 2 Click at the lower side of the **LIVE** page, and then select **Face, Human, Vehicle** or **Non-Motor Vehicle**.



The figure uses **Human** for example and is for reference only.

Figure 6-75 Human

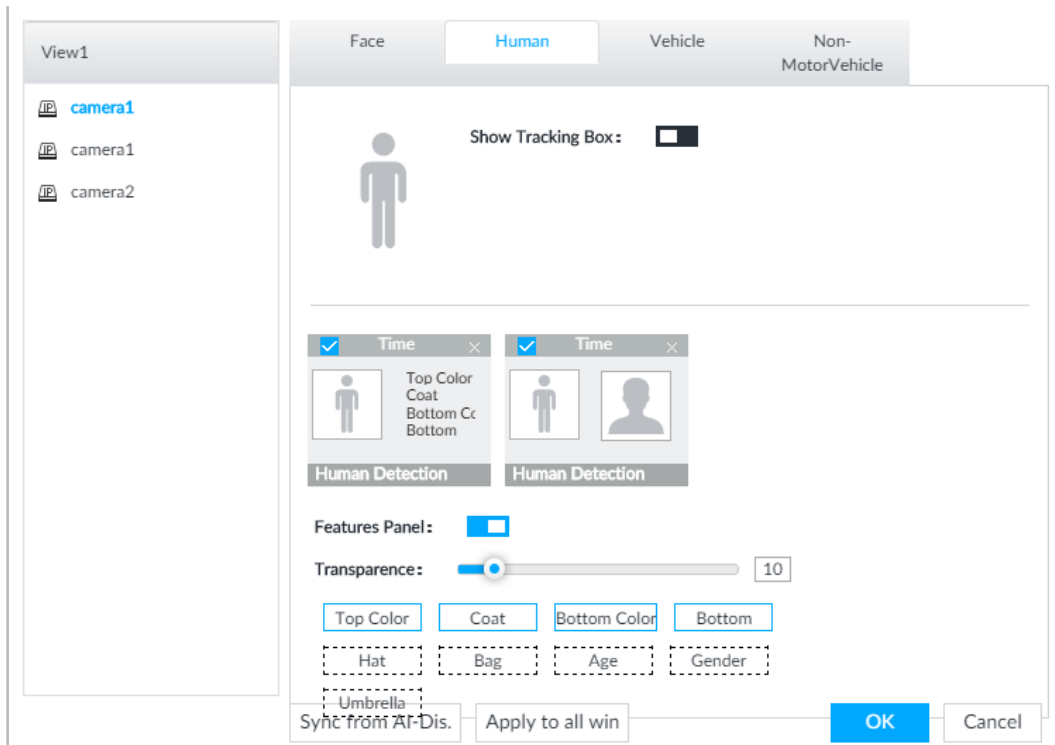

Step 3 Click next to **Show Tracking Box**, and then a tracking box is displayed in the video when target that meets the filtering conditions is detected.

Step 4 Configure feature panel.

- 1) Click next to **Features Panel** to enable feature panel.
- 2) A features panel is displayed on the right side of the video when target that meets the conditions is detected.
- 3) Click to select the panel type, for example, the **Human Detection** tab.
- 4) (Optional) Drag to adjust the transparency of panel. The higher the value is, the more transparent the panel will be.
- 5) (Optional) Select the features to be displayed in the panel.
 - Up to 4 features can be displayed.
 - 4 features are selected by default. To select another feature, click the selected feature to cancel it, and then click the feature to be displayed.

Step 5 Click **OK**.

6.5.3.2 Live View

On the **LIVE** page, select a view from **View Group**, and the video image of the view will be displayed.

- Rule box is displayed in real-time in the video image. Different detection targets correspond to different colors of rule box.
- Features panels are displayed on the right side of the video image.

Figure 6-76 Live

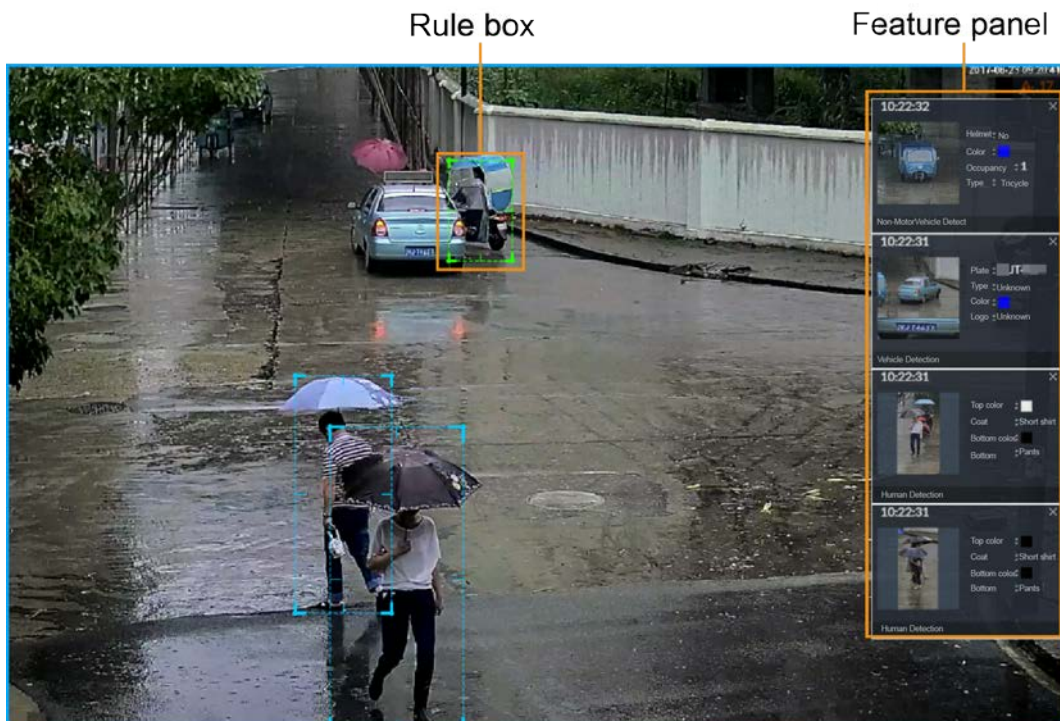

Point to the features panel, and the icons are displayed.

Figure 6-77 Icons (vehicle detection)

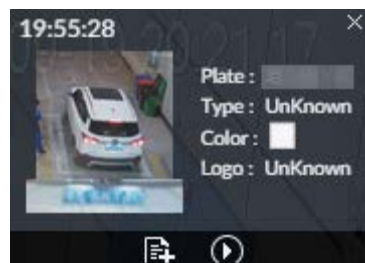

- Click to add plate information to plate database.
- Click or double-click the detected image to play back the video record (10 s before and after the snapshot).
- Click to search for similar targets in the history videos.

6.5.3.3 Detection Statistics

View the detection statistics of human, motor vehicle and non-motor vehicle.

6.5.3.3.1 Human

On the **LIVE** page, click .

Click , and then select **Snap With Face** and **Snap Without Face**. The information of detected human and face is displayed.

Figure 6-78 Human detection



- Point to the snapshot, and then click to add the face image to face database. For details, see "6.3.3.4.3 Adding Face Image".



This function is available when face image is captured.

- Point to the snapshot, and then click or double-click the picture to play back the video record (10 s before and after the snapshot).
- Point to the snapshot, and then click to export the video record to specified saving path.
- Point to the snapshot, and then click to search for similar targets in the snapshot records.



Make sure that USB storage device is connected during local operation.

6.5.3.3.2 Motor Vehicle

On the **LIVE** page, click , the **VEHICLE TOTAL** page is displayed.

Click , and then select **Vehicle Recognition**, the information of detected vehicles is displayed.

Figure 6-79 Motor vehicle detection



- Point to the panel, and then click to add the license plate image to plate database. For details, see "6.8.3.2.3 Adding from Detection Results".
- Point to the panel, and then click , or double-click detected picture to play back the video record (10 s before and after the snapshot).
- Point to the panel, and then click to export the video record to specified saving path.



Make sure that USB storage device is connected during local operation.

6.5.3.3.3 Non-motor Vehicle

On the **LIVE** page, click .

Click , and then select **Snap With Face** and **Snap Without Face**. The information of detected non-motor vehicles is displayed.

Figure 6-80 Non-motor vehicle detection

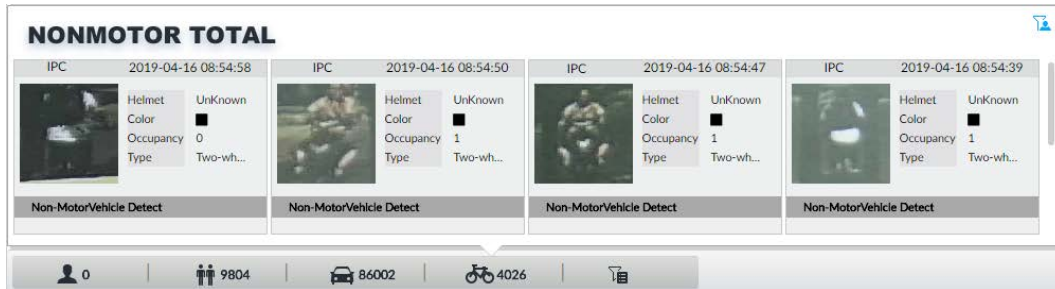

- Point to the detected information, and then click , or double-click detected picture to play back the video record (10 s before and after the snapshot).
- Point to the detected information, and then click to export the video record to specified saving path.



Make sure that USB storage device is inserted during local operation.

- Point to the snapshot, and then click to search for similar targets in the snapshot records.



appears on the panel of the non-motor vehicle snapshot that contains a human face.

6.5.4 AI Search

Select device and set properties to search for detection results.

6.5.4.1 Human Search

Select device and set human properties to search human detection results.

6.5.4.1.1 Searching by Property

Procedure

Step 1 On the LIVE page, click , and then select **AI SEARCH > Search by Human**.

Figure 6-81 Search by human

Step 2 Select one or more devices, and then select **Human Detection** as **Event Type**.

Step 3 Select alarm type.

Step 4 Set human properties and time period.

Click or to set the color. means more than one color.

Step 5 Click **Query**.

- If face is captured, the human and face snapshots are displayed.
- If no face is captured, the human snapshot and human properties are displayed.

Figure 6-82 Search result

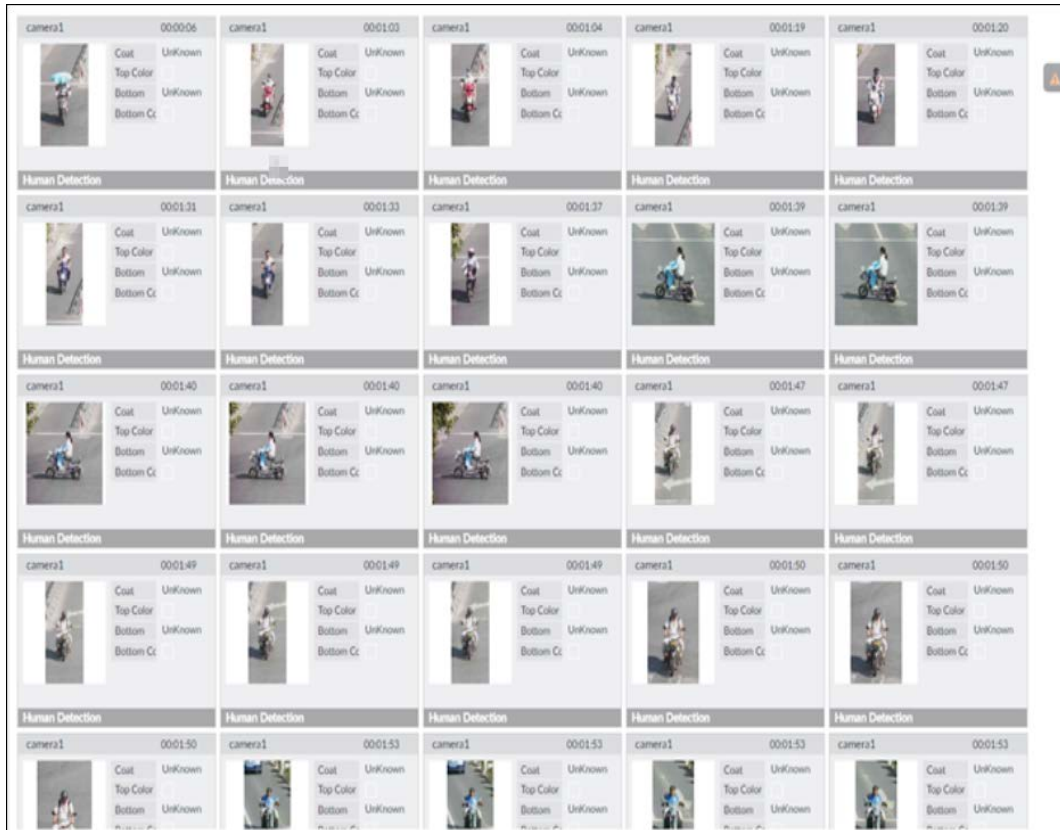

Related Operations

Click one displayed panel, and the icons are displayed.

Figure 6-83 Icons (1)



Figure 6-84 Icons (2)

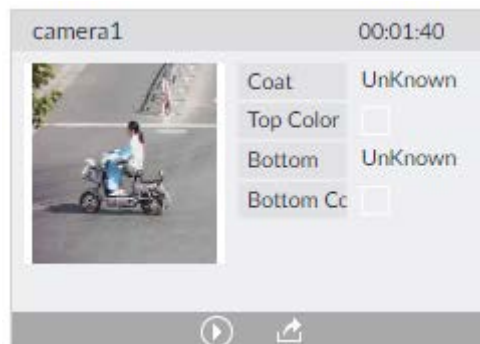











Table 6-15 Operation

Icon	Operation
	<ul style="list-style-type: none"> Select one by one: Click <input type="checkbox"/> to select the panel. <input checked="" type="checkbox"/> means the panel is selected. Select in batches: Select All to select all the panels on the page.
	Click  or double-click the panel to play back the video record (10 s before and after the snapshot).
	Click  to add picture to database. See "6.3.3.4.3 Adding Face Image".
	<ul style="list-style-type: none"> Export one by one: Click  to export picture, video and video player. For details, see "6.2.4.3 Exporting Face Records". Export in batches: Select the panel and click  to export picture, video and excel. For details, see "6.2.4.3 Exporting Face Records". <p>After setting alarm linkage snapshot, during exporting images, the system exports detected images and panoramic images at the time of snapshot.</p>
	Click  to search for similar targets in the snapshot records.

6.5.4.1.2 Searching by Image

Upload human body pictures to search for similar targets.



The search by image function is only available when feature vector extraction is enabled. For details, see Step 4 in "6.5.2 Configuring Video Metadata".

Searching Devices

Upload human body pictures to search the specific devices for similar targets.

1. On the **LIVE** page, click , and then select **AI SEARCH > Search by Human > By Image**.

Figure 6-85 Search by image

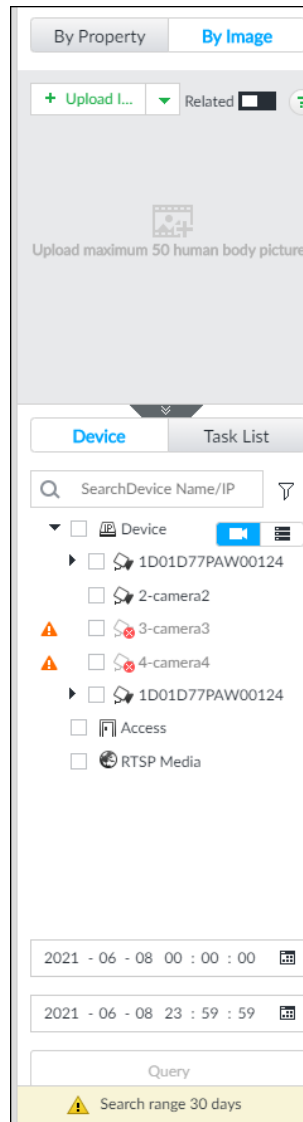

2. Click the **Device** tab.
3. Upload a picture.
Upload from PC or USB storage device.



Up to 50 pictures can be uploaded. Up to 10 pictures can be uploaded at a once.

- a. Point to **+ Upload Image**, and then select **Local**.
- b. Select one or more pictures.
- c. Click **OK**.

After the upload is completed, the uploaded picture is shown at the upper-left corner of the page. The latest 10 pictures are displayed by default.



Up to 10 pictures can be selected at the same time.

4. Click to enable related search. If related search is enabled, the system searches for both face detection results and human detection results.

Figure 6-86 Related search

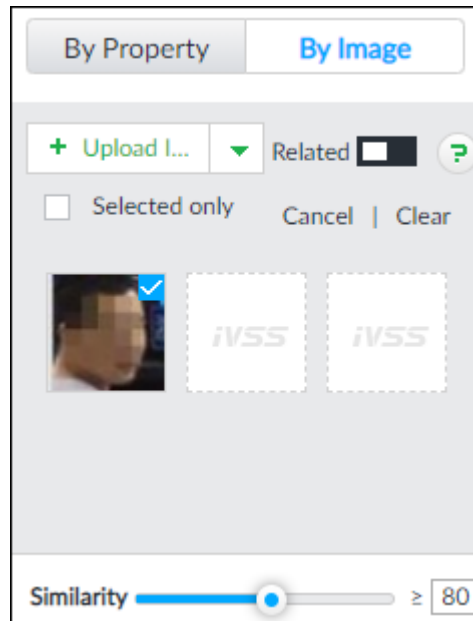

5. Set similarity. It is 80% by default.
6. Select a remote device in the device list, and then set search time.
7. Click **Query**.

Searching Task List

Upload a human body picture search the analyzed video for similar targets. For details about AI tasks, see "7.4.1 AI Analysis Task".

1. On the **LIVE** page, click **+**, and then select **AI SEARCH > Search by Human > By Image**.
2. Click **Task List**.

Figure 6-87 Task list

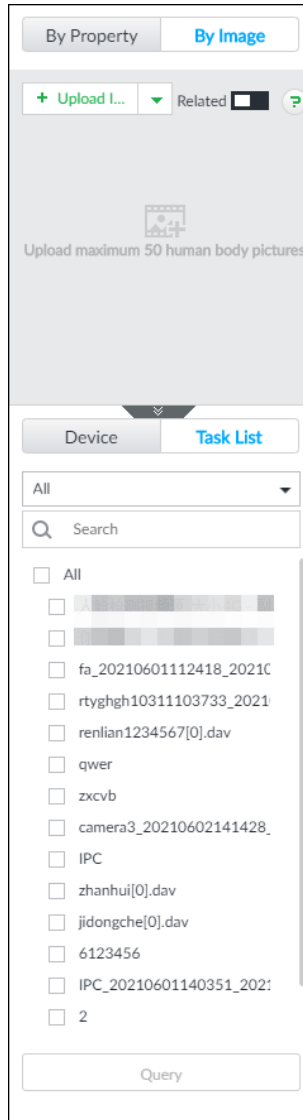

3. Upload a human body picture. For details, see step 3 in "6.2.4.2.1 Searching Devices".
4. Click to enable related search. If related search is enabled, the system searches for both face detection results and human detection results.

Figure 6-88 Related search

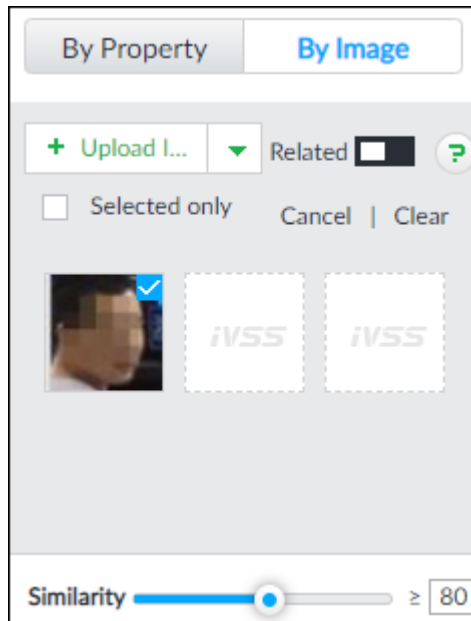

5. Set similarity. It is 80% by default.
6. Select a task to be searched.
7. Click **Query**.

Managing Search Results

Figure 6-89 Search results

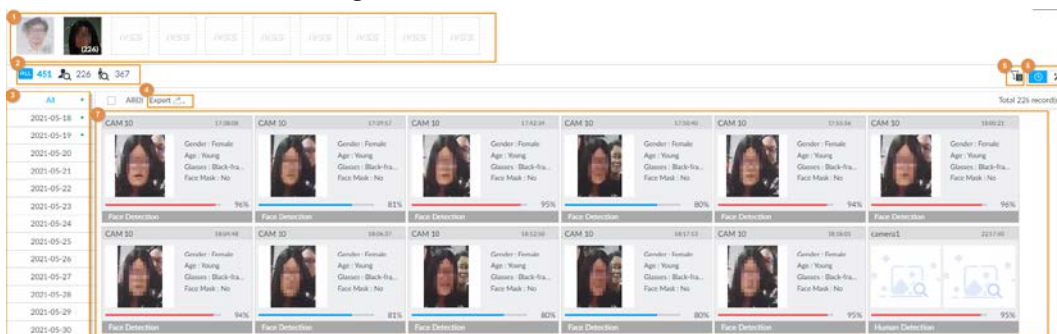

Table 6-16 Search results page description

No.	Function
1	<ul style="list-style-type: none"> ● Displays the selected search images. The number at the lower-right corner of the image represents the number of records found. ● Click the image to view detailed results.
2	<ul style="list-style-type: none"> ● ALL: displays the number of images found. ● : Displays the number of face images found. ● : Displays the number of human body images found. <p> The numbers are displayed only when related search is enabled.</p>
3	<ul style="list-style-type: none"> ● Displays the dates within the selected search range. ● Click a date and the records of that day are displayed.

No.	Function
4	Select the panel and click to export picture, video or excel. For details, see "6.2.4.3 Exporting Face Records".
5	Filter the search results according to properties.
6	<ul style="list-style-type: none"> : Sort the records by time. : Sort the records by similarity.
7	Displays the face panels, including face image, feature property and similarity.

6.5.4.2 Vehicle Search

Set event type and vehicle properties to search vehicle detection results.

Step 1 On the **LIVE** page, click , and then select **AI SEARCH > Search by Vehicle**.

Step 2 Select device, and then click **Property** tab.

Figure 6-90 Property

The screenshot shows the 'Property' configuration page. At the top, there is a 'Device' dropdown menu. Below it is a search bar labeled 'SearchDevice Name/IP'. A list of devices is shown with checkboxes: '1D01D77PAW00124', '4-Channel40', '5-camera5', '6-CAM 10', '7-camera7', and '8-camera1'. There are two tabs: 'Property' (active) and 'Plate Database'. The 'Event Type' is set to 'Vehicle Detection'. The 'Alarm type' is set to 'All'. Under 'Vehicle Property', there are dropdowns for 'Type' (All), 'Color' (multi-color icon), 'Logo' (All), and 'Plate' (multi-color icon). A text input field for 'Plate' contains 'Enter Plate Number'. At the bottom, there are two date range selectors: '2021 - 06 - 15 00 : 00 : 00' and '2021 - 06 - 15 23 : 59 : 59'. A blue 'Query' button is present, and a yellow warning box at the bottom indicates 'Search range 30 days'.

Step 3 Select **Vehicle Detection** as **Event Type**.

Step 4 Select alarm type.

Step 5 Set vehicle properties and time period.

Step 6 Click or to set the color. means more than one color.

Step 7 Click **Query**.

The search results are displayed.

If license plate is detected, both the scenario and the license plate will be displayed.

Figure 6-91 Search result

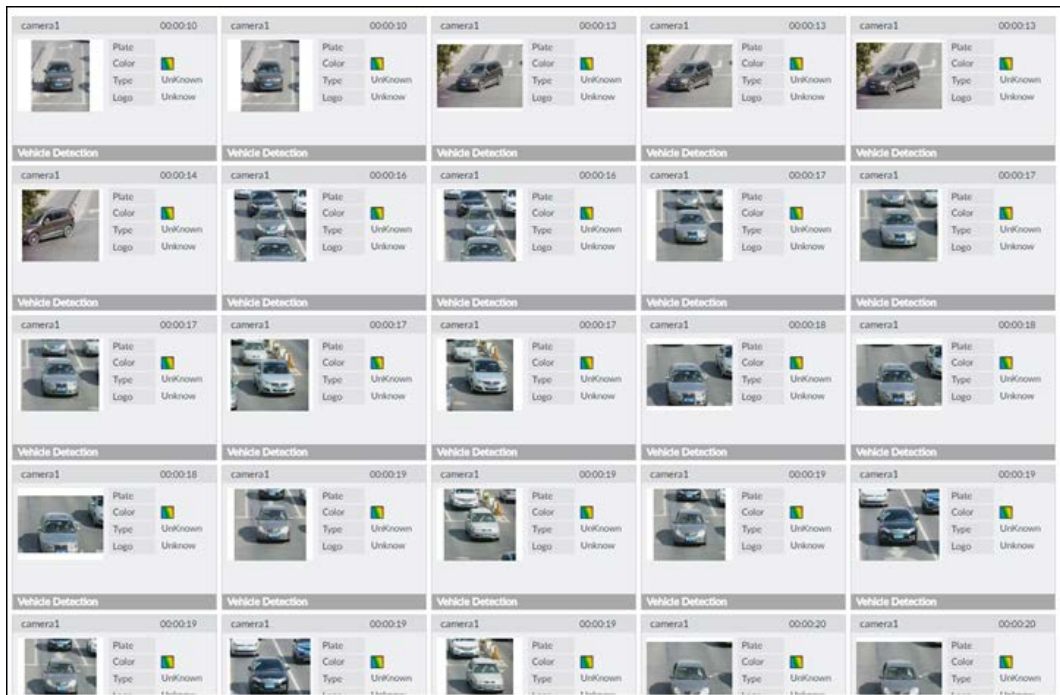

Click one displayed panel, and the icons are displayed.

Figure 6-92 Icons

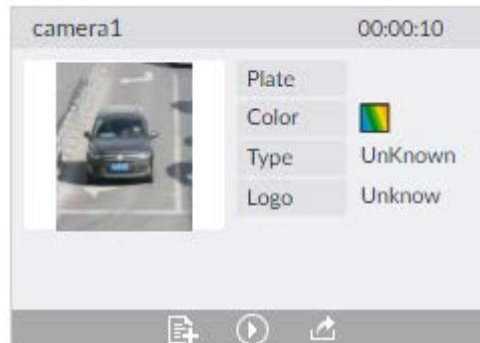

Table 6-17 Operation

Icon	Operation
	<ul style="list-style-type: none"> Select one by one: Click <input type="checkbox"/> to select the panel. <input checked="" type="checkbox"/> means the panel is selected. Select in batches: Select All to select all the panels on the page.
	Click or double-click the panel to play back the video record (10 s before and after the snapshot).
	Click to add picture to database. See "6.3.3.4.3 Adding Face Image".

Icon	Operation
	<ul style="list-style-type: none"> Export one by one: Click to export picture, video and video player. For details, see "6.2.4.3 Exporting Face Records". Export in batches: Select the panel and click to export picture, video or excel. For details, see "6.2.4.3 Exporting Face Records". <p>After setting alarm linkage snapshot, during exporting images, the system exports detected images and panoramic images at the time of snapshot.</p>

6.5.4.3 Non-motor Vehicle Search

Set event type and non-motor vehicle properties to search non-motor vehicle detection results.

Step 1 On the **LIVE** page, click , and then select **AI SEARCH > Search by NonMotor**.

Figure 6-93 Search by non-motor vehicle

Step 2 Select the device you want to search.

Step 3 Select **Non-motor Vehicle** as **Event Type**.

Step 4 Select alarm type.

Step 5 Set non-motor vehicle properties and time period.

Step 6 Click or to set the color. means more than one color.

Step 7 Click Query.

Figure 6-94 Search results



Figure 6-95 Icons

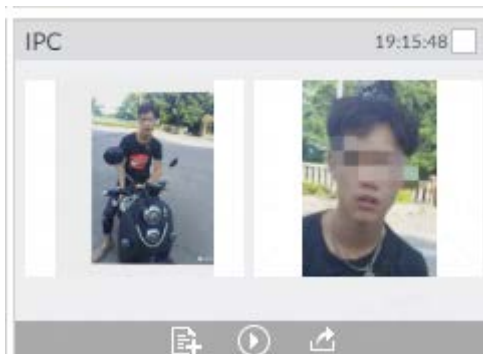

Table 6-18 Operation

Icon	Operation
	<ul style="list-style-type: none"> Select one by one: Click <input type="checkbox"/> to select the panel. <input checked="" type="checkbox"/> means the panel is selected. Select in batches: Select All to select all the panels on the page.
	Click or double-click the panel to play back the video record (10 s before and after the snapshot).
	<ul style="list-style-type: none"> Export one by one: Click to export picture, video and video player. For details, see "6.2.4.3 Exporting Face Records". Export in batches: Select the panel and click to export picture, video or excel. For details, see "6.2.4.3 Exporting Face Records". <p>After setting alarm linkage snapshot, during exporting images, the system exports detected images and panoramic images at the time of snapshot.</p>
	Click to add picture to database. See "6.3.3.4.3 Adding Face Image".
	Click to search for similar targets in the snapshot records.

6.6 IVS

The IVS feature includes a number of behavior detections such as fence-crossing, intrusion, tripwire, parking, crowd gathering, missing object, abandoned object, and loitering. You can configure alarm notifications of those intelligent detections.

This section introduces how to configure the intelligent detections.



Some device models only support some IVS functions by device.

6.6.1 Enabling AI Plan

Enable AI plan when AI by camera is used. See "6.2.1 Enabling AI Plan" to enable AI detect function.

6.6.2 Configuring IVS

Configure IVS model and rules.

6.6.2.1 Switching IVS Model

This function is only effective to AI by Device.

Step 1 Click , or click  on the configuration page, and then select **EVENT**.

Step 2 Select the root node in the device tree on the left.

Step 3 Select **AI Application > IVS Module Switch**.

Step 4 Select a model as you need.

Figure 6-96 Switch IVS model

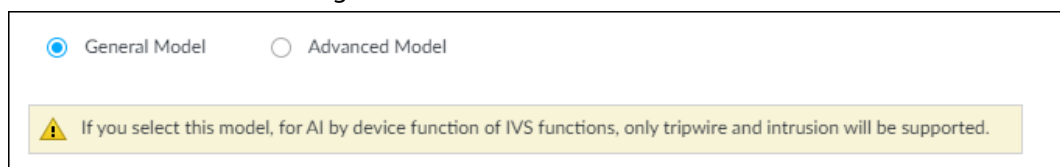

- General model: Supports only tripwire and intrusion.
- Advanced model: Supports tripwire, intrusion, people gathering, parking detection, and loitering.



- The Advanced Model includes more detections but supports fewer channels.
- You need to configure IVS AI-by-Device event again after switching IVS model.

6.6.2.2 Global Configuration

Configure global rules of IVS, including anti-disturbance and sensitivity settings.



Global configuration is needed only when AI by camera is used.

Step 1 Click , or click  on the configuration page, and then select **EVENT**.

Step 2 Select a device in the device tree on the left.

Step 3 Select **AI Application > IVS > AI By Camera > Global Config.**

Figure 6-97 Global config

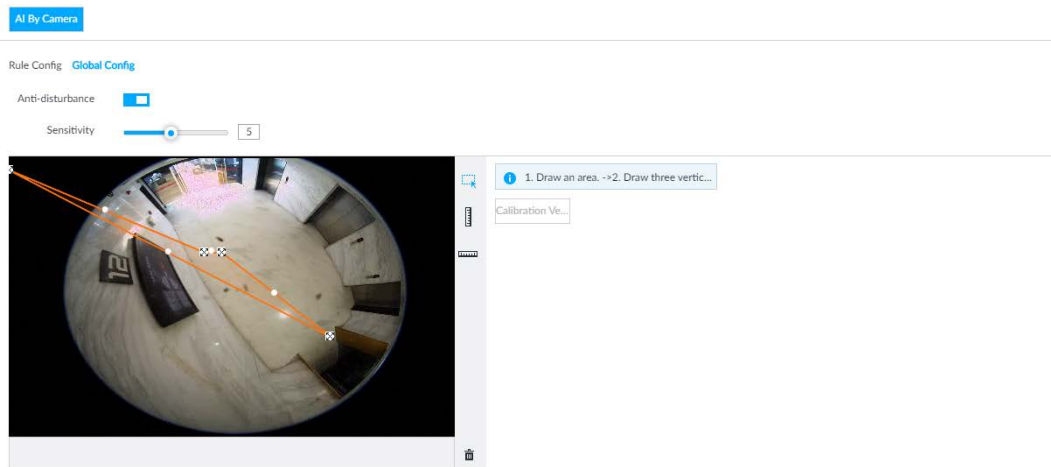

Step 4 Configure anti-disturbance and sensitivity settings.

- Click to enable anti-disturbance function.
- Drag to adjust sensitivity.

Step 5 Calibrate horizontal and vertical scales.

- 1) Click to draw an area.
- 2) Click to draw three vertical lines, enter the actual length, and then click **Calibration Verification.**
- 3) Click to draw a horizontal line, enter the actual length, and then click **Calibration Verification.**

Step 6 Click **Save.**

6.6.2.3 Rule Configuration

Configure IVS rules. IVS functions are different between AI by camera and AI by device.

- IVS functions with AI by camera: Crossing fence, tripwire, intrusion, abandoned object, parking detection, people gathering, object removed, and loitering. Different cameras support different functions.
- IVS functions with AI by device differ depending on the IVS model.
 - ◇ General model: Supports only tripwire and intrusion.
 - ◇ Advanced model: Supports tripwire, intrusion, people gathering, parking detection, and loitering.

Table 6-19 IVS functions description

Functions	Description	Scene
Tripwire	When the target crosses tripwire from the defined motion direction, an alarm is triggered, and then the system performs configured alarm linkages.	Scenes with sparse targets and no occlusion among targets, such as the perimeter protection of unattended area.

Functions	Description	Scene
Intrusion	When the target enters, leaves, or appears in the detection area, an alarm is triggered, and the system performs configured alarm linkages.	
Abandoned Object	When an object is abandoned in the detection area over the configured time, an alarm is triggered, and then the system performs configured alarm linkages.	Scenes with sparse targets and without obvious and frequent light change. Simple scene in the detection area is recommended. <ul style="list-style-type: none"> • Missed alarm might increase in the scenes with dense targets, frequent occlusion, and people staying. • In scenes with complex foreground and background, false alarm might be triggered for abandoned or missing object.
Missing Object	When an object is taken out of the detection area over the defined time, an alarm is triggered, and then the system performs configured alarm linkages.	
Fast Moving	When the target moves fast in the detection area, an alarm is triggered, and then the system performs configured alarm linkages.	Scene with sparse targets and less occlusion. The camera should be installed right above the monitoring area. The light direction should be vertical to the motion direction.
Parking Detection	When the vehicle stays in the detection area longer than the configured duration, an alarm is triggered, and then the system performs configured alarm linkages.	Road monitoring and traffic management.
Crowd Gathering	When people gather and stay in the detection area longer than the defined duration, an alarm is triggered, and then the system performs configured alarm linkages.	Scenes with medium or long distance, such as outdoor plaza, government entrance, station entrance and exit. It is not suitable for short-distance view analysis.
Loitering	When the target loiters over the shortest alarm time, an alarm is triggered, and then the system performs configured alarm linkages.	Scenes such as park and hall.
Crossing Fence	When the target crosses the warning line toward the defined direction, an alarm is triggered and then the system performs configured alarm linkages.	Scenes with median strips such as roads, and airports.

This section uses the configuration of tripwire as the example.

Step 1 Click  or click  on the configuration page, and then select **EVENT**.

Step 2 Select remote device in the device tree on the left.

Step 3 Select **AI Application > IVS**. Click **AI by Camera** or **AI by Device**.

Figure 6-98 AI by camera

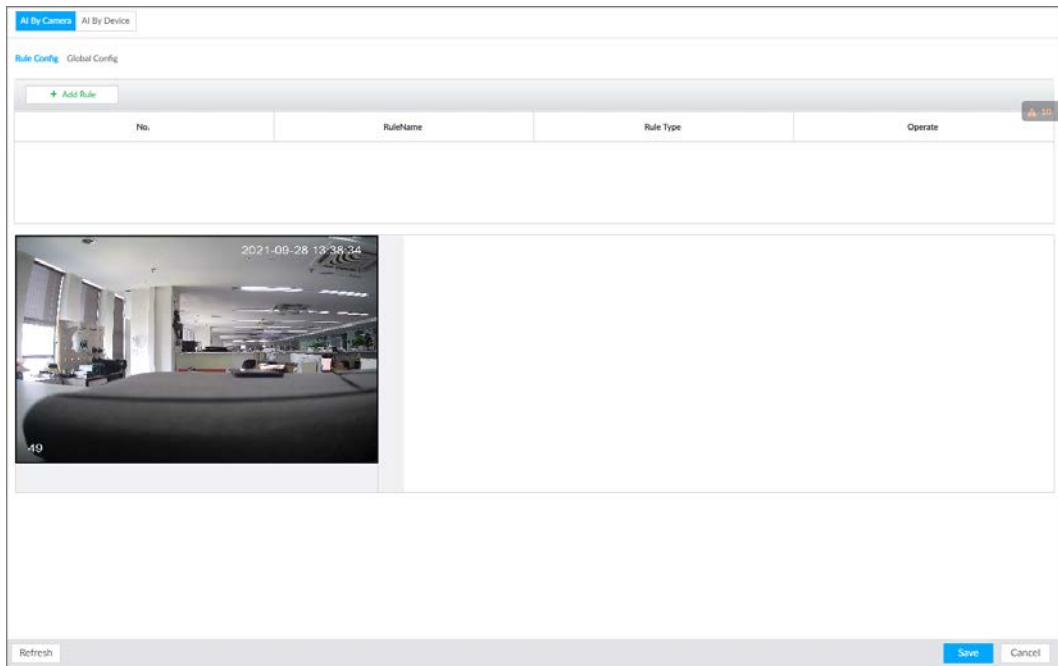
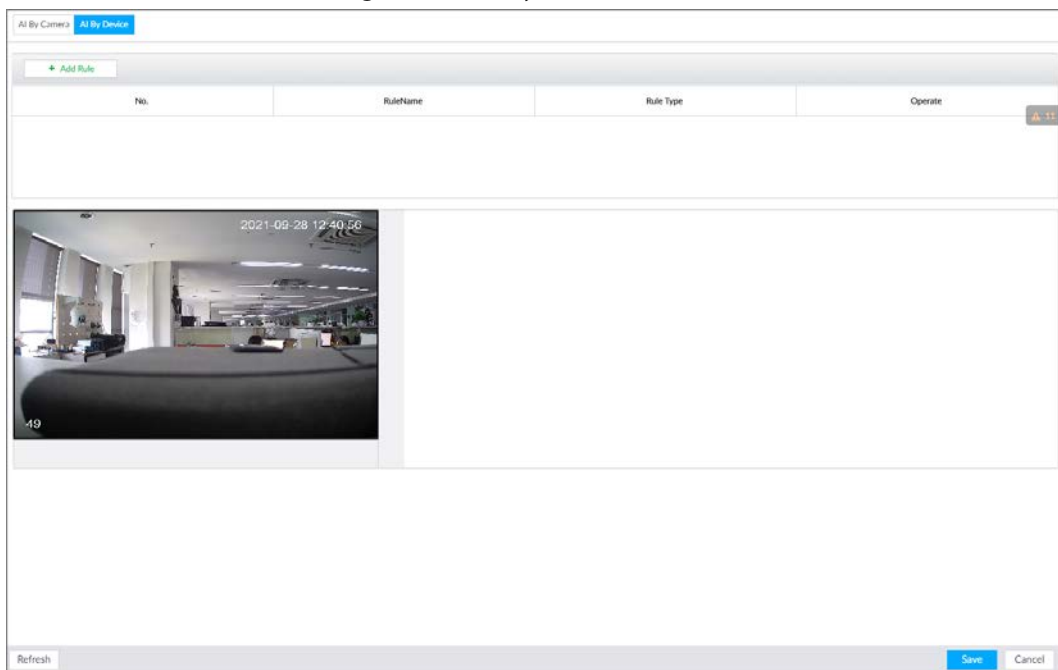

Figure 6-99 AI by device



Step 4 Set tripwire rules.

- 1) Click **Add Rule**, and then select **Tripwire**.
- 2) Click to enable detection rule.
Click to delete detection rule.
- 3) Click to edit the tripwire line.
 - Drag to adjust position or length of the line.
 - Click or to set the directions. An alarm will be triggered only when the target crosses the line in the designated direction.
 - Click the white dot on the line to add a turning point. Drag at the turning point to adjust position or length.

Figure 6-100 Configure tripwire detection rules



- 4) Click or to set minimum size or maximum size of detection target. System triggers an alarm once the detected target size is between the maximum size and the minimum size.

Step 5 Configure AI recognition and sensitivity.

After setting AI recognition, when the system detects a person, vehicle or non-motor vehicle, a rule box will appear beside the target on the video.

- 1) Click to enable AI recognition function.

Figure 6-101 Type



- 2) Select a recognition type.
- is to recognize human, and is to recognize vehicle.
 - After enabling AI recognition function, you need to select at least one recognition type.
- 3) Configure sensitivity.
- The higher the sensitivity, the easier to trigger tripwire alarm, but meanwhile the higher probability of false alarm.



Sensitivity is available when AI by device is used or when AI by camera is used and the camera supports this function.

Step 6 Click **Deployment Time** to select schedule from the drop-down list.

After setting deployment period, system triggers corresponding operations when there is a motion detection alarm in the specified period.



If the schedule is not added or the added schedule does not meet actual needs, click **Add Schedule**.

Step 7 Click **Actions** to set alarm action. See "8.4.1 Alarm Actions" for detailed information.

Step 8 Click **Save**.



Repeat Step 4 through Step 8 to add multiple detection rules. You can add max. 10 detection rules at the same time.

6.6.3 Live View of IVS

On the **LIVE** page, view real-time IVS results.

6.6.3.1 Setting AI Display

Set the display rules of detection results.



Make sure that view is created before setting AI display. To create view, see "7.1.1 View Management".

Step 1 Select a view from **LIVE > View > View Group**.

Step 2 Click , and then select the **Human**, **Vehicle** or **Non-Motor Vehicle** tab.

Figure 6-102 Human

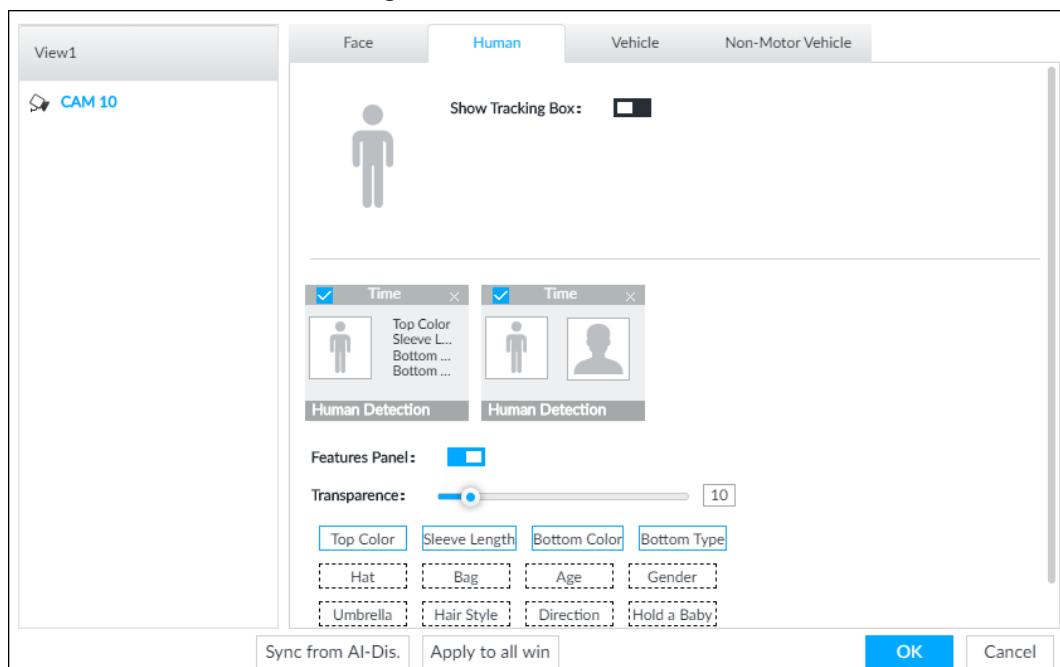

Figure 6-103 Vehicle

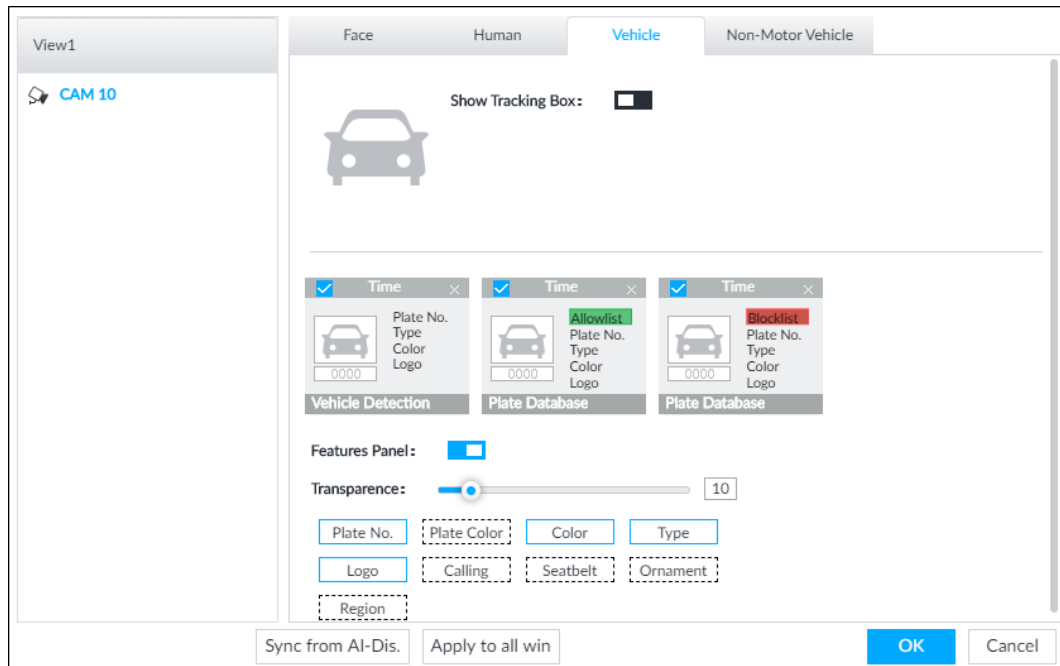
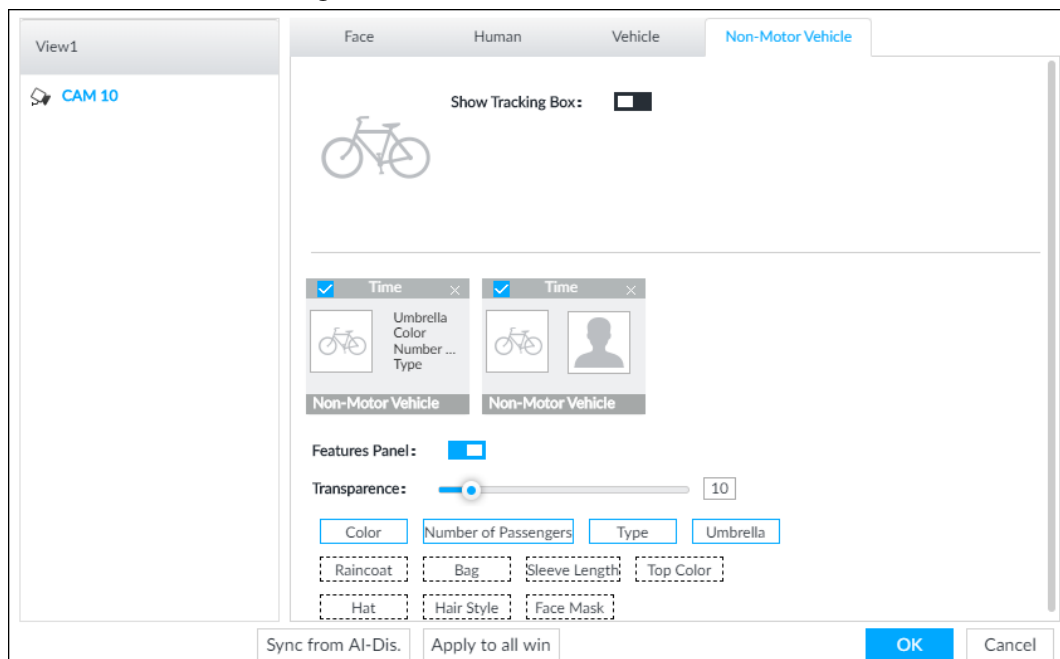

Figure 6-104 Non-motor vehicle



Step 3 Configure feature panel.

- 1) Click next to **Features Panel** to enable feature panel.
- 2) A features panel is displayed on the right side of the video when a target that meets the conditions is detected.
- 3) Click to select the panel type, for example, the **Human Detection** tab.
- 4) (Optional) Drag to adjust the transparency of panel. The higher the value, the more transparent the panel.
- 5) (Optional) Select the features to be displayed in the panel.
 - Up to 4 features can be displayed.
 - 4 features are selected by default. To select another feature, click the selected feature to cancel it, and then click the feature to be displayed.

Step 4 Click OK.

6.6.3.2 Live View

Go to the **LIVE** page, enable view, and then the Device displays view video.

- When a target triggers cross line or cross region rule, the line or region frame in the view flickers in red.
- After setting AI recognition, when the system detects a person or vehicle, a rule frame will appear beside the person and vehicle in the view.
- There is a feature panel on the right side of the video window.

Figure 6-105 Live

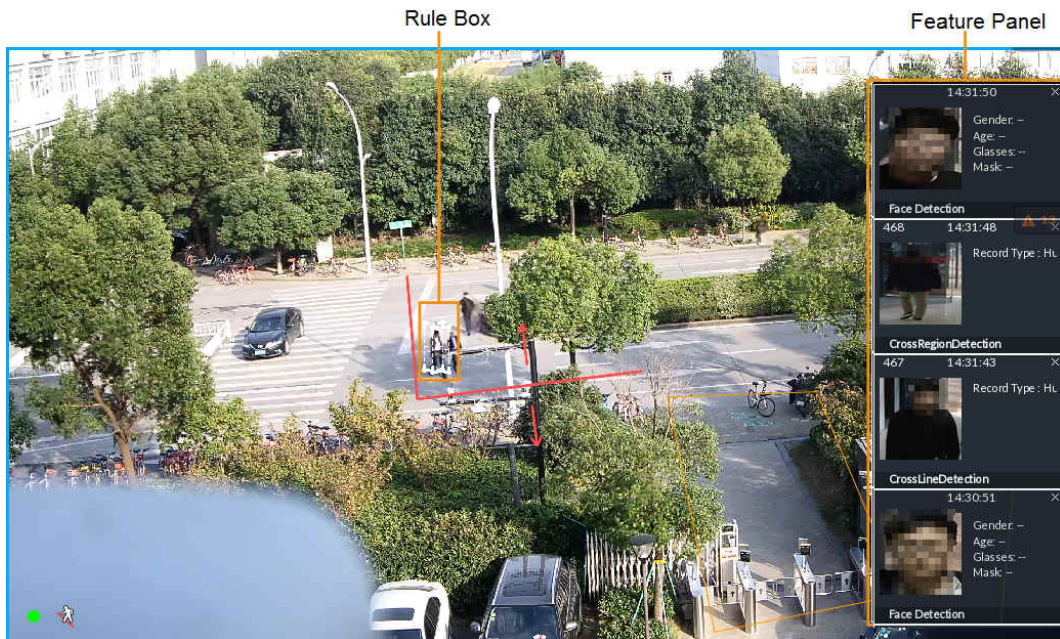

Point to features panel, and the operation icons are displayed.

- Click or double-click the detected image, so the system starts to play back the recorded videos (10 s before and after the snapshot).
- Click to search for similar faces.

6.6.3.3 Detection Statistics

On the **LIVE** page, click . The **PEOPLE TOTAL** window is displayed. Click , and then select **IVS**.



Figure 6-106 People total



Click . Click , and then select **IVS**. The detected vehicles are displayed.

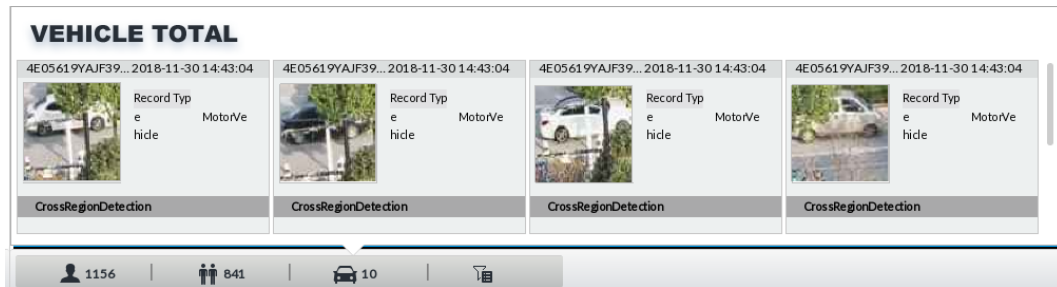

Figure 6-107 Vehicle total





- Point to a picture and click , or double-click the picture, so the system starts playing back video (10 s before and after the snapshot moment).
- Point to a picture and click  to export video and picture.



Make sure that USB storage device is connected during local operation.

On the **LIVE** page, click . The **NON-MOTOR VEHICLE TOTAL** window is displayed. Click , and then select **IVS**. The detected non-motor vehicles are displayed.

- Point to a picture and click , or double-click the picture, so the system starts playing back video (10 s before and after the snapshot moment).
- Point to a picture and click  to export video and picture.

6.6.4 IVS Search

Search for IVS records.

Step 1 On the **LIVE** page, click  and then select **AI SEARCH > IVS**.

Step 2 Select the remote device, and set event type, effective target and time.

Step 3 Click **Query**.

Figure 6-108 Search result

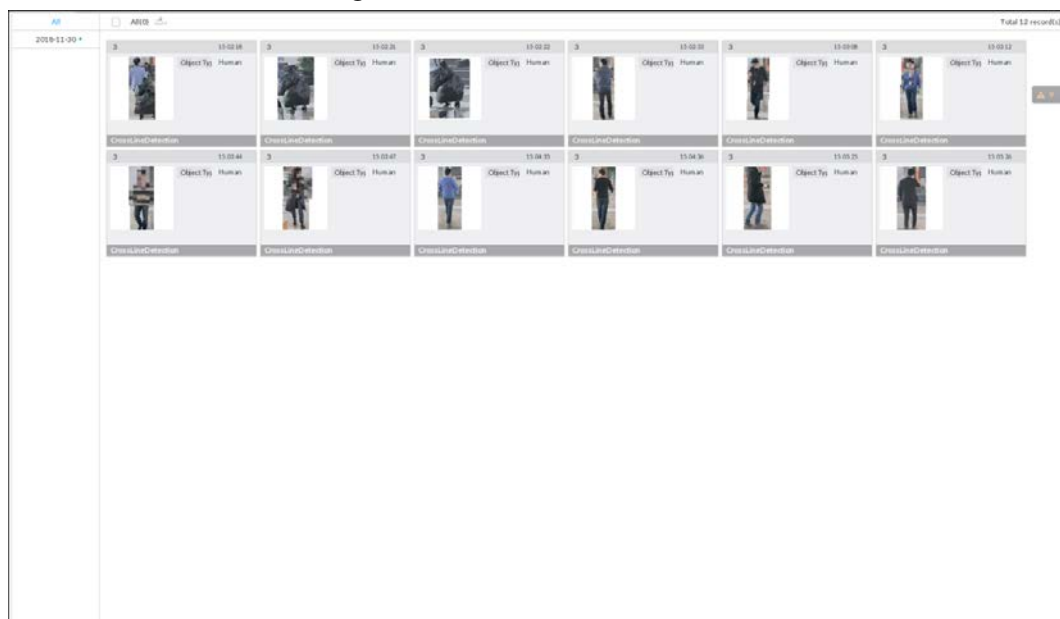

Click the panel. The following operation icons are displayed.

Table 6-20 More operations

Name	Operation
Select a panel	<ul style="list-style-type: none"> Select one by one: Move the mouse pointer onto the panel. Click to select the panel. means it is selected. Click ALL to select all the panels.
Playback	Click the panel, and click or double-click the panel. The system starts to play back the recorded videos (10 s before and after the snapshot).
Export file	<ul style="list-style-type: none"> Export one by one: Click to export picture, video and video player. For details, see "6.2.4.3 Exporting Face Records". Export in batches: Select the panel and click to export picture, video or excel. For details, see "6.2.4.3 Exporting Face Records".

6.7 Vehicle Recognition

Alarm is triggered when vehicle property that meets detection rule is detected.



The Device supports only vehicle recognition through AI by camera. Make sure that the vehicle recognition parameters of camera are configured. For details, see the user's manual of the camera.

6.7.1 Enabling AI Plan

Before using AI by camera, AI plan needs to be enabled first. For details, see "6.2.1 Enabling AI Plan".

6.7.2 Setting Vehicle Recognition

Set the deployment time of vehicle recognition and alarm linkage event.

Step 1 Click or and then select **EVENT**.

Step 2 Select device from the device tree at the left side.

Step 3 Select **AI Application > Vehicle Recognition**.



AI by camera is enabled by default and cannot be disabled.

Figure 6-109 Vehicle recognition

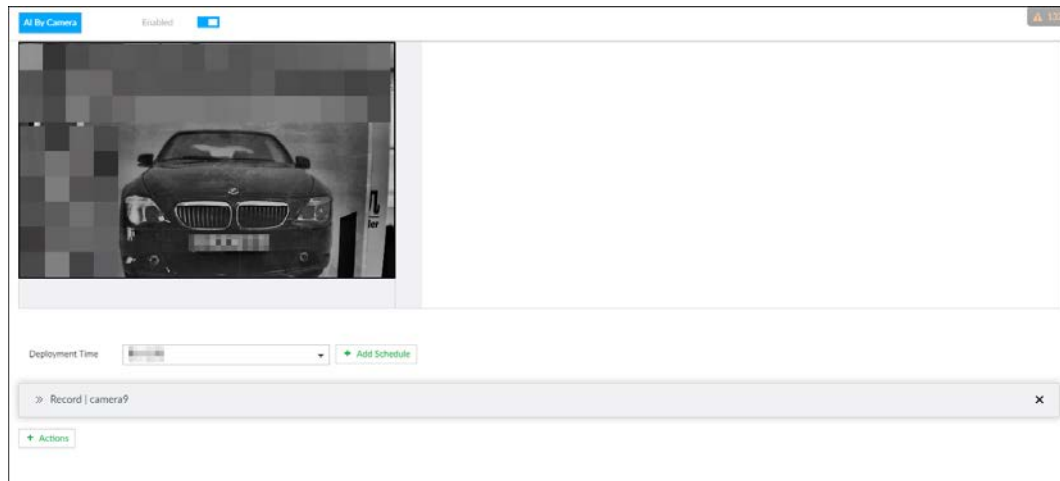

- Step 4** Click the **Deployment Time** drop-down list to select schedule. IVSS links alarm event when alarm is triggered within the defined schedule.
- Click **View Schedule** to view detailed schedule settings.
 - If the schedule is not added or the added schedule does not meet actual needs, click **Add Schedule**. For details, see "8.8.4 Schedule".
- Step 5** Click **Actions** to set alarm action. For details, see "8.4.1 Alarm Actions".
- Step 6** Click **Save**.

6.7.3 Live View of Vehicle Recognition

View vehicle recognition results on the **LIVE** page.

6.7.3.1 Setting AI Display

Set the display rules of detection results.



Make sure that view is created before setting AI display. To create view, see "7.1.1 View Management".

- Step 1** Select a view from **LIVE > View > View Group**.
- Step 2** Click , and then select **Vehicle** tab.

Figure 6-110 Motor vehicle



- Step 3** Click next to **Show Tracking Box** to enable tracking box function. A tracking box is displayed in the video image when target meeting detection rule is detected.
- Step 4** Set features panel.
- 1) Click next to **Features Panel** to enable features panel function.
 - 2) Features panel will be displayed at the right side of video image when target with selected features is detected.
 - 3) Select the **Vehicle Detection** panel type by clicking . means the panel is selected.
 - 4) (Optional) Drag to adjust the transparency of panel. The higher the value, the more transparent the panel.
 - 5) (Optional) Select the features to be displayed in the panel.
 - Up to 4 features can be displayed.
 - 4 features are selected by default. To select another feature, click the selected feature to cancel it, and then click the feature to be displayed.
- Step 5** Click **OK**.

6.7.3.2 Live View

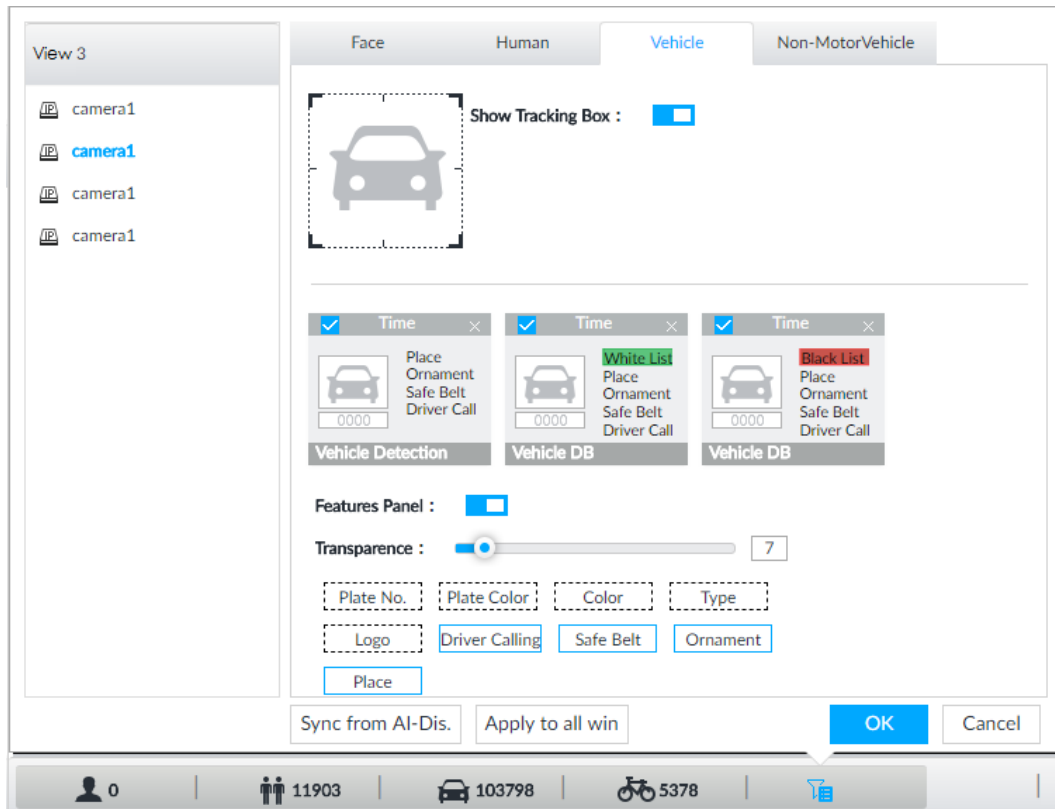
On the **LIVE** page, select a view, and the video image of the view is displayed.

- Tracking box is displayed in the video image.
- Features panel is displayed at the right side of the video image.

Figure 6-111 Live



Point to the features panel, and the operation icons are displayed.

- Click to add license plate information to the plate database. For details, see "6.8.3.2.3 Adding from Detection Results".
- Click or double-click the vehicle image to play back the video image (10 s before and after the snapshot).

6.7.3.3 Detection Statistics

On the **LIVE** page, select a view and then click . The **VEHICLE TOTAL** page is displayed.

Click , and then select **Vehicle Detection**. The information of detected vehicles is displayed.

Figure 6-112 Vehicle detection

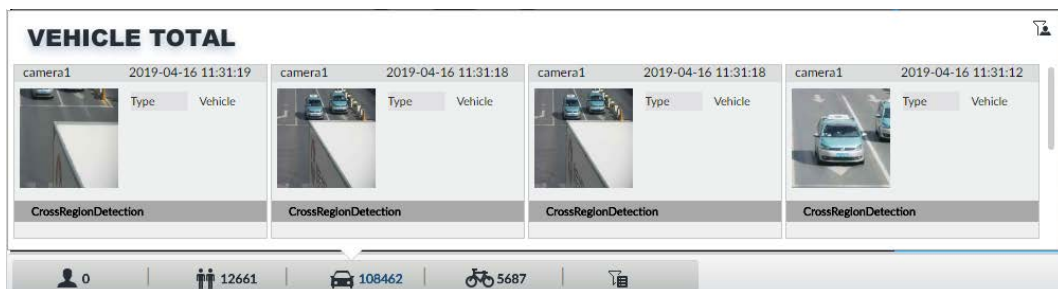

- Point to the information panel, and then click to add license plate information to plate database. For details, see "6.8.3.2.3 Adding from Detection Results".
- Point to the information panel, and then click or double-click the picture to play back the video image (10 s before and after the snapshot).
- Point to the information panel, and then click to export the video and picture to specified saving path.



Make sure that USB storage device is connected during local operation.

6.7.4 Searching for Detection Information

Set event type and vehicle properties, and then search for vehicle detection information. For details, see "6.5.4.2 Vehicle Search".

6.8 ANPR

The system detects number plates using video metadata or vehicle recognition, and then compares the detected number plates with the ones in the database. When the system detects a match, an alarm is triggered.



Video metadata is only applicable to ANPR for low-speed vehicles at daytime checkpoints. Do not use video metadata for ANPR at entrances and exits, high-speed checkpoints or night scenes.

6.8.1 Procedure



6.8.2 Setting Vehicle Detection

To use the ANPR function, make sure that the system detects vehicles using video metadata or vehicle recognition. For details on configuring video metadata, see "6.5 Video Metadata". For details on configuring vehicle recognition, see "6.7 Vehicle Recognition".

6.8.3 Configuring Vehicle Database

Set vehicle database, and then the Device can compare vehicle plates with information in the database.

6.8.3.1 Creating Vehicle Database

Create vehicle database, and then classify and manage the database. Database of safe trusted vehicle list and blocked vehicle list can be created.

Procedure

- Step 1 On the **LIVE** page, click **+**, and then select **FILE > Vehicle Management > Vehicle Database**.
- Step 2 Click **Create Vehicle DB**.
- Step 3 Set **Vehicle DB Name**, and select **Type** of vehicle database.
- Step 4 Click **Register Vehicle** or **Save and close**. For details, see "6.8.3.2 Registering Vehicle Information".

Figure 6-114 Register vehicle info

- Click **Save and close** to create database without editing its information.
The newly-created database can be viewed on the **Vehicle Database** page.

Related Operations

After creating a database, you can modify the database name, register plate information, arm the database, and delete the database.

Table 6-21 Related Operations

View database information and status	<ul style="list-style-type: none"> • Database 2: Database name. • 🚗 1: Number of vehicle plates in the database. • Allowlist/Blocklist: The database is in the allowlist or blocklist. • 🚫 Disarmed: The database is not linked to channel for vehicle plate comparison. If armed, the linked device channel will be displayed.
Modify database name	Click next to the database name to modify its name.
Manage database	Double-click the database, and you can manage the vehicle plate information in the database. For details, see "6.8.3.3 Managing Vehicle Information".
Arm database	Link the database to camera channel for vehicle plate comparison. For details, see "6.8.4 Configuring Number Plate Comparison".
Delete database	<ul style="list-style-type: none"> • Delete one by one: Point to the database, and click at the upper-right corner to delete it. • Delete in batch: Point to a database, and check <input type="checkbox"/> to select the database. Select multiple databases in this way, and then click to delete the selected databases. <p>Delete all: Select All, and then click to delete all databases.</p>

6.8.3.2 Registering Vehicle Information

Add vehicle information to the created database. You can add vehicles one by one, in batches or directly add from the detection results.

6.8.3.2.1 Manual Add

Step 1 On the LIVE page, click **+**, and then select **FILE > Vehicle Management > Vehicle Database**.

Step 2 Double-click the database.

Figure 6-115 Database

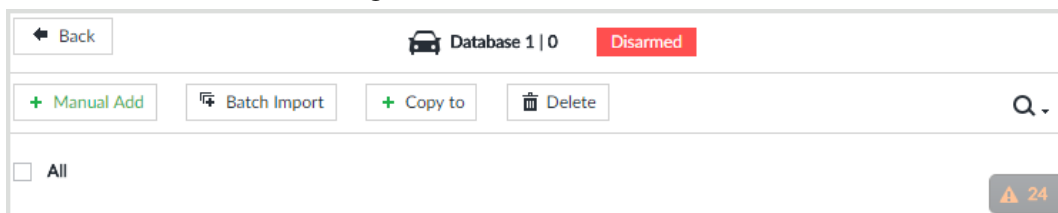

Step 3 Click **Manual Add**.

Figure 6-116 Vehicle register

Step 4 Set the parameters.

Table 6-22 Vehicle register parameters

Parameters	Description
Country or Region	The country or region that the vehicle belongs to.
Name	Driver name.
Driver ID	Driver license number.
Cell Phone	Driver phone number.
Email	Driver email.
Address	Driver address.
Plate	Vehicle plate number.
Logo	Vehicle logo.
Color	Click to select the color of vehicle.



Parameters	Description
Plate Color	Click  to select the color of vehicle plate.
Type	Click  , and you can select the vehicle type. Blue means already selected.

Figure 6-117 Vehicle type



- Step 5** Click **Save and continue to add** or **OK**.
- Click **Save and continue to add**: Save the current vehicle information, and then **Continue to add** next vehicle.
 - Click **OK**: Save the current vehicle information.

6.8.3.2.2 Batch Import

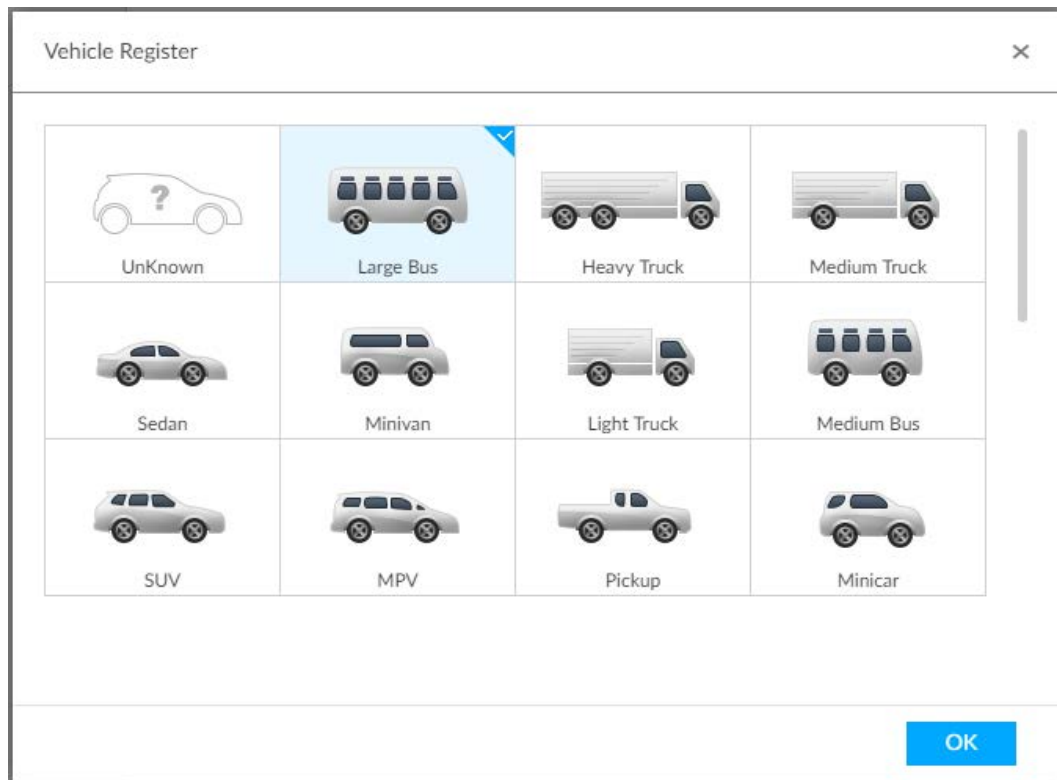
Import vehicle information in batches.

- Step 1** On the **LIVE** page, click , and then select **FILE > Vehicle Management > Vehicle Database**.
- Step 2** Double-click the database.
- Step 3** Click **Batch Import**.



Figure 6-118 Batch import

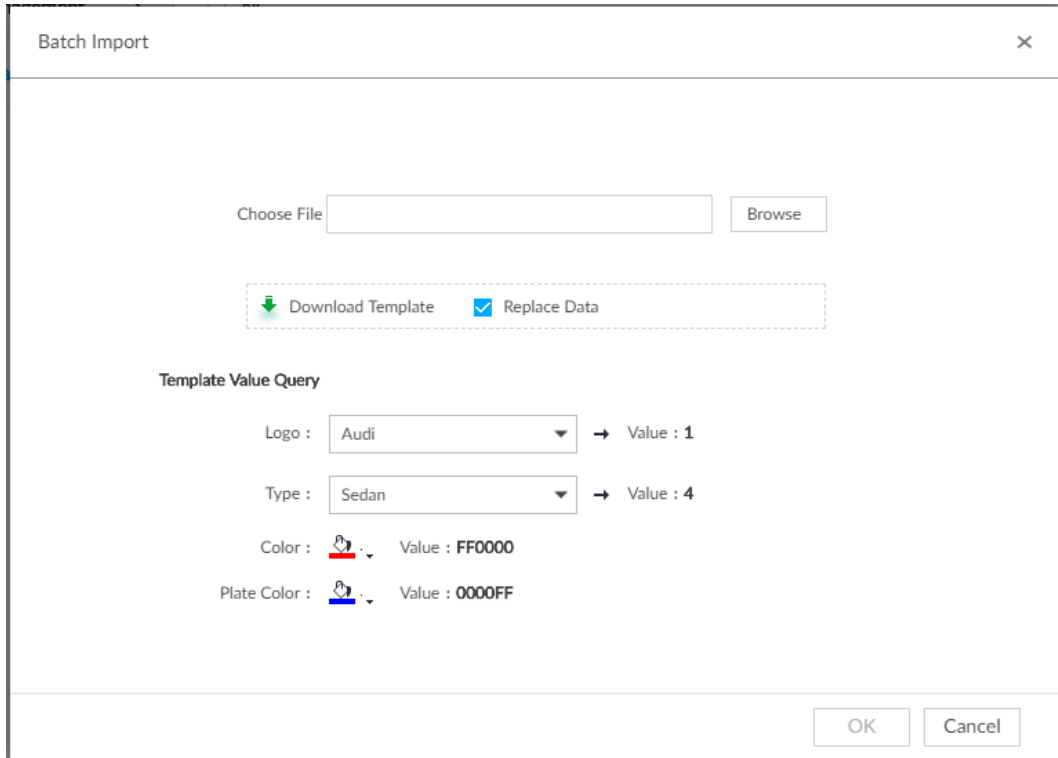

Step 4 Acquire and fill in the template file.

1) Click **Download Template** to download the template to local PC or USB storage device.

The saving path might vary when operating on client or local interface.

- On client: Click  on the upper right side, and then select  | Download to view the saving path of template file.
- On local interface: Select the saving path of template file.
- On web interface: Template file is saved in the default download path of browser.

2) Fill in the template according to your actual needs.

Fill in the vehicle information according to the instructions. For logo, type, color, and plate color, fill in the corresponding code or value. Search the code or value on the **Batch Import** interface.

Step 5 On the **Batch Import** page, click **Browse** to import template file.

If the plate number in the template is the same as the number in the database, select **Replace Data** to overlap the information in the database.

Step 6 Click **OK**.

Step 7 Click **Add More** or **OK**.

- Click **Add More**: Import vehicle information, and **Continue to add** vehicle information.
- Click **OK**: Import vehicle information.

The added vehicle information can be viewed on the **Vehicle Database** page.

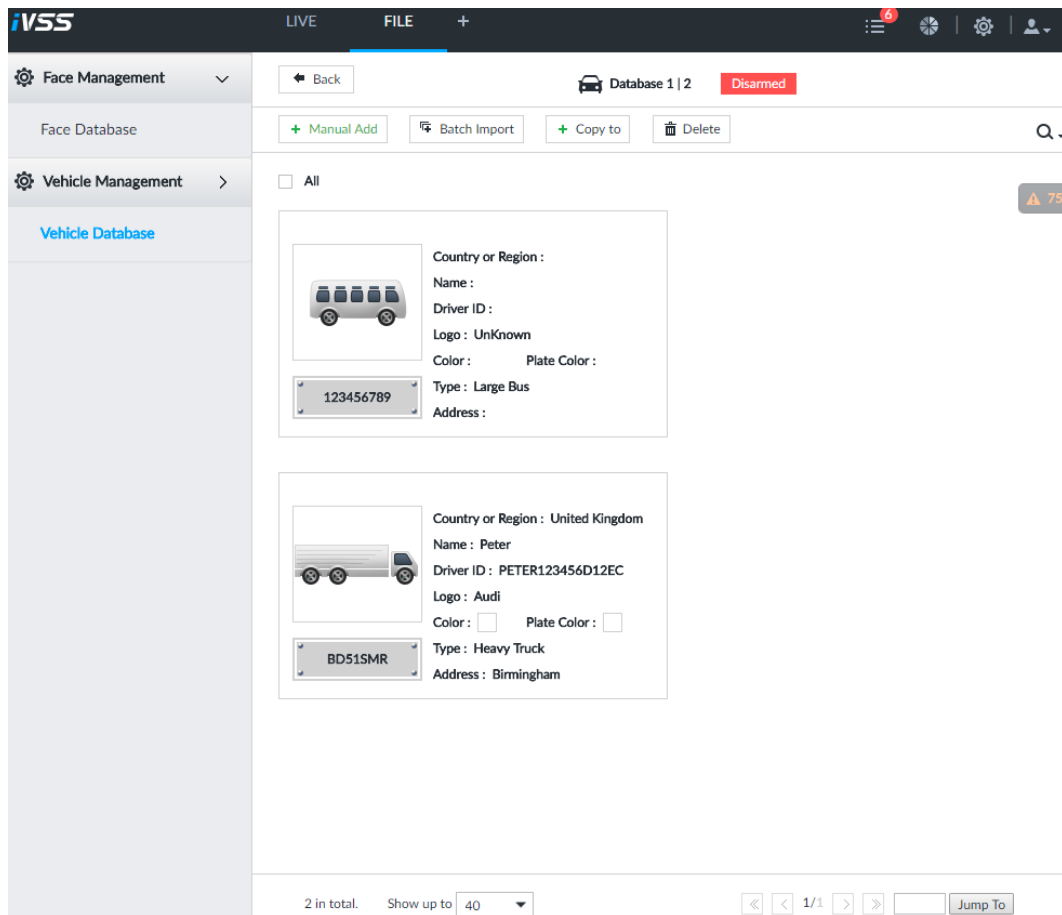

Figure 6-119 Vehicle information



6.8.3.2.3 Adding from Detection Results

Add plate information from vehicle recognition or detection results to the database.

Step 1 On the **LIVE** page, select the vehicle information to be added.

- Click , move the mouse pointer to the information panel, and then click .
- On the **Vehicle Recognition** or **Video Metadata** page, move the mouse pointer to the vehicle recognition or vehicle detection panel, and then click .

The **Vehicle Register** page is displayed.

Step 2 Select a vehicle database from **Vehicle DB**, and enter the plate number at **Plate**. Other information can be filled in according to actual conditions.

Step 3 Click **OK**.

6.8.3.3 Managing Vehicle Information

After registering vehicle information, the information needs to be properly managed and maintained to keep it accurate and complete.

On the **LIVE** page, click , and then select **FILE > Vehicle Management > Vehicle Database**. The database page is displayed.

On the page, the information can be edited, copied, or deleted.

6.8.3.3.1 Editing Vehicle Information

- Step 1** Point to the database, and then click .
- Step 2** Modify vehicle information according to actual needs.
- Step 3** Click **OK**.

6.8.3.3.2 Copying Vehicle Information

Copy the vehicle information in a database to another database. You can only copy and apply the vehicle information to a database of the same type. For example, vehicle information in a blacklist database can only be copied to another blacklist database.

- Step 1** Point to the database, and then click .



- Multiple vehicle information can be selected at a time.
- Select **All** to select information of all vehicles on the page.

- Step 2** Click .

The **Copy to** page is displayed.

Figure 6-120 Copy to

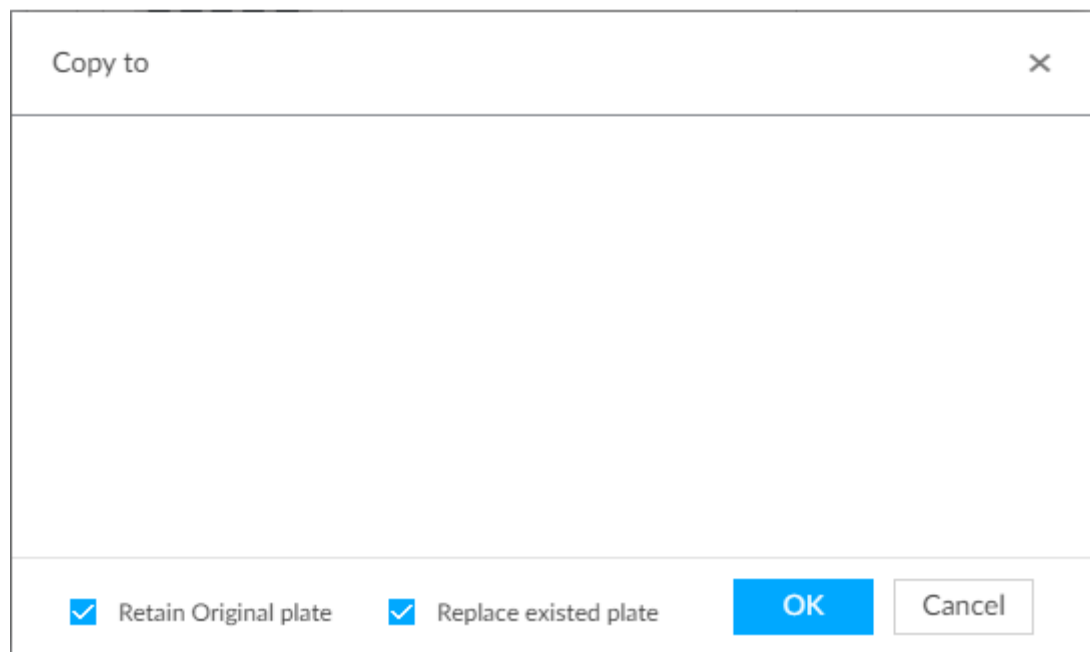

- Step 3** Select the target database.



- Multiple databases can be selected at a time. Blue means already selected.
- Select **Retain Original plate**: When the same plate is detected, the vehicle information in the target database will not be replaced.
- Select **Replace existed plate**: When the same plate is detected, the vehicle information in the target database will be replaced.

- Step 4** Click **OK**.

6.8.3.3 Deleting Vehicle Information

- Delete one by one: Point to the database, and then click  at the upper right corner to delete the database.
- Delete in batch
 - ◇ Point to the database, and then click at the upper left corner to select the database. Select multiple databases in this way, and then click to delete selected databases.
 - ◇ Select **All**, and then click to delete all the databases on the page.

6.8.4 Configuring Number Plate Comparison

Set the alarm triggering rules after plate comparison.



The section uses AI by device for example, and might differ from the actual interface.

Step 1 Click  or  on the configuration page, and then select **EVENT**.

Step 2 Select device from the device tree on the left side.

Step 3 Select **AI Application > Plate Comparison**.

Figure 6-121 Plate comparison

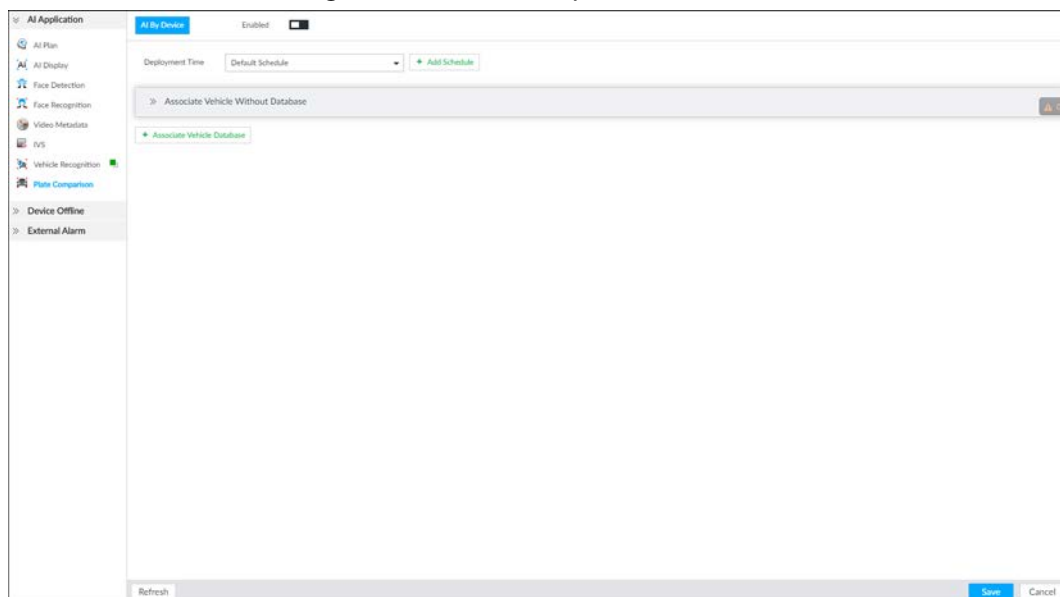

Step 4 Click to enable plate comparison. The icon changes to .

Step 5 Click **Deployment Time** drop-down list to select schedule.

The Device links alarm event when an alarm is triggered within the schedule configured.

- Click **Add Schedule** to add new schedule if no schedule is added or the existing schedule does not meet requirements. For details, see "8.8.4 Schedule".
- Click **View Schedule** to view details of schedule.

Step 6 Link vehicle without database.

Enable linkage of vehicle without database. Alarm is triggered when vehicle not in the database is detected.

1) Click .

Figure 6-122 Associate vehicle without database



Step 7 Link database.



Repeat the following steps to link multiple databases.

- 1) Click **Associate Vehicle Database**, and select the database to be linked.

Figure 6-123 Database linkage

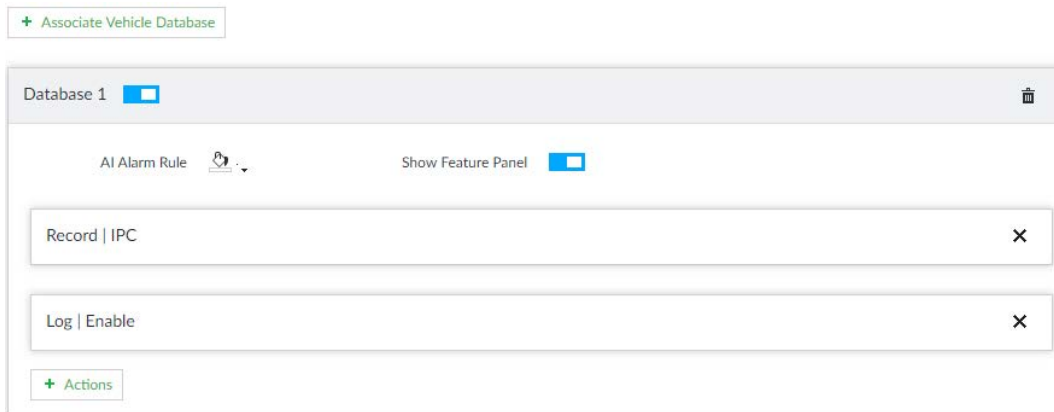



Table 6-23 Database linkage parameters

Parameters	Description
AI Alarm Rule	Click  to set the color of alarm rule box.
Show Feature Panel	Click <input checked="" type="checkbox"/> , and when alarm is triggered, the plate comparison information is displayed in the feature panel of video image.

Step 8 Click **Save**.

6.8.5 Live View of ANPR

View vehicle comparison results on the **LIVE** page.

6.8.5.1 Setting AI Display

Set the display rules of detection results.



Make sure that view is created before setting AI display. To create view, see "7.1.1 View Management".

Step 1 Select a view from **LIVE > View > View Group**.

Step 2 Click , and then select **Vehicle** tab.

Figure 6-124 Vehicle



Step 3 Click next to **Show Tracking Box** to enable tracking box function. A tracking box is displayed in the video image when target meeting detection rule is detected.

Step 4 Set features panel.

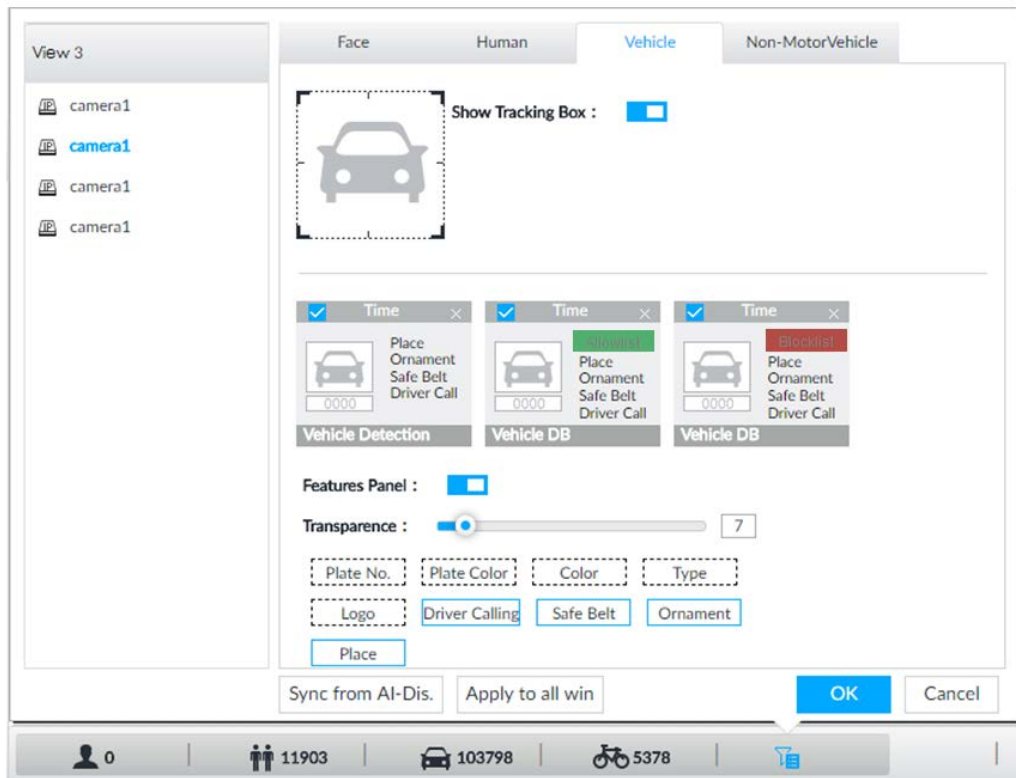
- 1) Click next to **Features Panel** to enable features panel function.
- 2) Features panel will be displayed at the right side of video image when target with selected features is detected.
- 3) Click to select the **Vehicle DB** panel. means the panel is selected.
- 4) (Optional) Drag to adjust the transparency of panel. The higher the value, the more transparent the panel.
- 5) (Optional) Select the features to be displayed in the panel.
 - Up to 4 features can be displayed.
 - 4 features are selected by default. To select another feature, click the selected feature to cancel it, and then click the feature to be displayed.

Step 5 Click **OK**.

6.8.5.2 Live View

On the **LIVE** page, select a view, and the video image of the view is displayed.

- Tracking box is displayed in the video image.
- Features panel is displayed at the right side of the video image.

Figure 6-125 Live



Point to the features panel, and the operation icons are displayed.

Figure 6-126 Icons

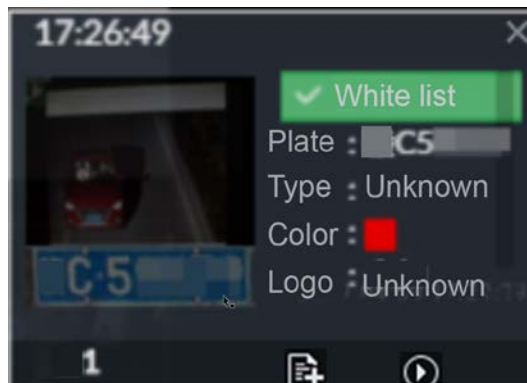

- Click to add license plate information to the plate database. For details, see "6.8.3.2.3 Adding from Detection Results".
- Click or double-click the vehicle image to play back the video image (10 s before and after the snapshot).

6.8.5.3 Detection Statistics

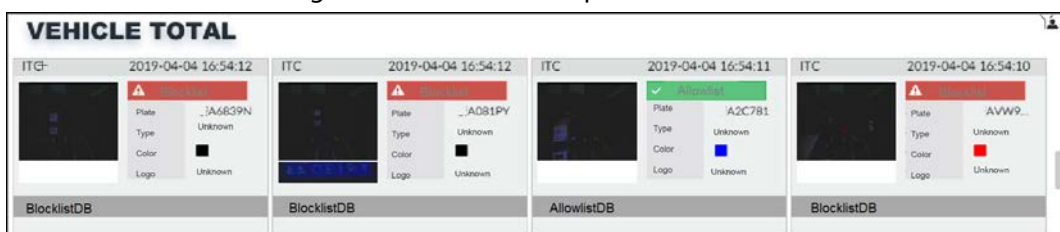

On the **LIVE** page, select a view and then click . The **VEHICLE TOTAL** page is displayed. Click , and then select **Vehicle Comparison (Blocklist)** and **Vehicle Comparison (Allowlist)**. The vehicle comparison result is displayed.

Figure 6-127 Vehicle comparison



- Point to the information panel, and then click to add license plate information to plate

database. For details, see "6.8.3.2.3 Adding from Detection Results".

- Point to the information panel, and then click  or double-click the picture to play back the video image (10 s before and after the snapshot).
- Point to the information panel, and then click  to export the video and picture to specified saving path.



Make sure that USB storage device is connected during local operation.

6.8.6 AI Search

Set search conditions such as device and properties, and then search information that meets the conditions. The Device supports searching by property and searching by database.

6.8.6.1 Searching by Property

Set search conditions such as device and properties, and then search vehicle recognition information that meets the conditions.

Step 1 On the **LIVE** page, click , and then select **AI SEARCH > Search by Vehicle**.

Step 2 Select device, and then click **Property** tab.

Figure 6-128 Search by property

The screenshot shows a search interface with the following elements:

- Device:** A dropdown menu set to "Device".
- Search:** A search bar with the placeholder "SearchDevice Name/IP" and a filter icon.
- Device List:** A list of devices with checkboxes and icons:
 - Device
 - 1D01D77PAW00124
 - 4-Channel40
 - 5-camera5
 - 6-CAM 10
 - 7-camera7
 - 8-camera1
 - 9-camera9
 - Access
 - RTSP Media
- Property:** A tab labeled "Property" is selected, with "Plate Database" as an alternative.
- Event Type:** A dropdown menu set to "Plate Comparison".
- Vehicle Property:**
 - Type: All
 - Color: [Color selection icon]
 - Logo: All
 - Plate: Enter Plate Number
- Time Range:** Two date-time pickers:
 - 2021 - 05 - 18 00 : 00 : 00
 - 2021 - 06 - 15 23 : 59 : 59
- Query:** A blue button labeled "Query".
- Warning:** A yellow warning icon and text "Search range 30 days".

Step 3 Select **Plate Comparison** as the **Event Type**.

Step 4 Set vehicle properties and time period.

Step 5 Click [Color selection icon] or [Dropdown arrow] to set the color. [Color selection icon] means more than one color.

Step 6 Click **Query**.

The search result is displayed.

If license plate is detected, both the scenario and the license plate will be displayed.

Figure 6-129 Search result

The screenshot shows a grid of search results. Each result panel includes:

- Image:** A small thumbnail of a vehicle.
- Plate:** The detected license plate number.
- Type:** The vehicle type (e.g., Sedan, SUV, Truck).
- Color:** The detected color.
- Logo:** The detected logo (e.g., Suzuki, Unknown, DS, RAM, Honda, BMW, Audi).

The results are organized in a grid with a date column on the left and a "Total 180 records" indicator on the right.

Click one displayed panel, and the icons are displayed.

Figure 6-130 Icons

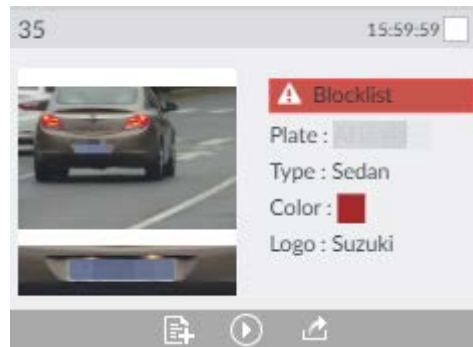

Table 6-24 Operations

Icon	Operation
	<ul style="list-style-type: none"> Select one by one: Point to the panel, and then click <input type="checkbox"/> at the upper right side to select the panel. <input checked="" type="checkbox"/> means the panel is selected. Select in batches: Select All to select all the panels on the page.
	Point to the panel, and then click or double-click the panel to play back the video record (10 s before and after the snapshot).
	Point to the panel, and then click to add picture to database. See "6.8.3.2.3 Adding from Detection Results".
	<ul style="list-style-type: none"> Export one by one: Click to export picture, video and video player. For details, see "6.2.4.3 Exporting Face Records". Export in batches: Select the panel and click to export picture, video or excel. For details, see "6.2.4.3 Exporting Face Records". <p>After setting alarm linkage snapshot, during exporting images, the system exports detected images and panoramic images at the time of snapshot.</p>

6.8.6.2 Searching by Database

Search vehicle recognition information according to database.

Step 1 On the LIVE page, click and then select **AISEARCH > Search by Vehicle**.

Step 2 Select device from the device tree, and then click **Plate Database** tab.

Figure 6-131 Search by vehicle database

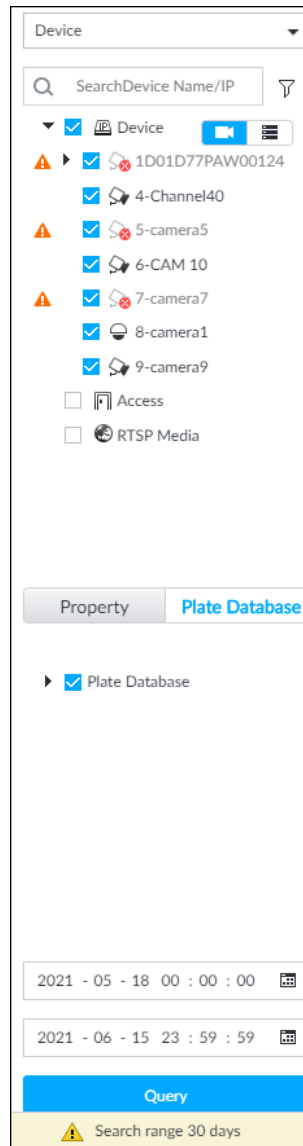

Step 3 Select the database to be searched.

Step 4 Click **Query**.

Step 5 The search result is displayed. If license plate is detected, both the scenario and the license plate will be displayed.

Click one displayed panel, and the icons are displayed. For operations of icons, see "6.8.6.1 Searching by Property".

6.9 Crowd Distribution Map

View and monitor people crowd to avoid crowd incidents, for example, stamped.



This function is only available with AI by camera.

6.9.1 Enabling AI Plan



Enable the corresponding AI plan before using AI by camera functions. For details, see "6.2.1 Enabling AI Plan".

6.9.2 Configuring Crowd Distribution Map

Set crowd distribution alarm rules.

6.9.2.1 Global Configuration

Draw lines on the image to determine the geographical scale of the image.

Step 1 Click  or click  on the configuration page, and then select **EVENT**.



Step 2 In the device tree, select a camera.

Step 3 Select **AI Application > Crowd Distribution Map > Global Config**.

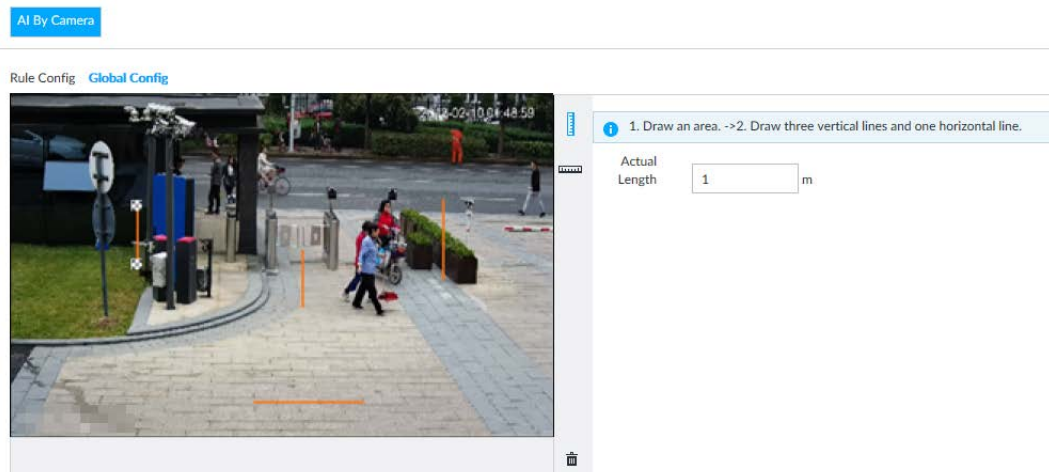
Figure 6-132 Global config



Step 4 Draw lines. Draw one horizontal line and three vertical lines.

- Click , draw vertical lines, and then enter their geographical distance values.
- Click , draw a horizontal line, and then enter the geographical distance value.

Step 5 Click **Save**.

6.9.2.2 Rule Configuration

Configure the alarm threshold for crowd monitoring. For example, when the crowd density reaches 8, an alarm is triggered.

Step 1 Click  or click  on the configuration page, and then select **EVENT**.

Step 2 In the device tree, select a camera.

Step 3 Select **AI Application > Crowd Distribution Map > Rule Config**.

Step 4 Click  next to **Enabled** to enable rule configuration.

Step 5 Set detection rules.

- Set regional detection rules.
- 1) Click **Add Rule**.

Figure 6-133 Add Rules

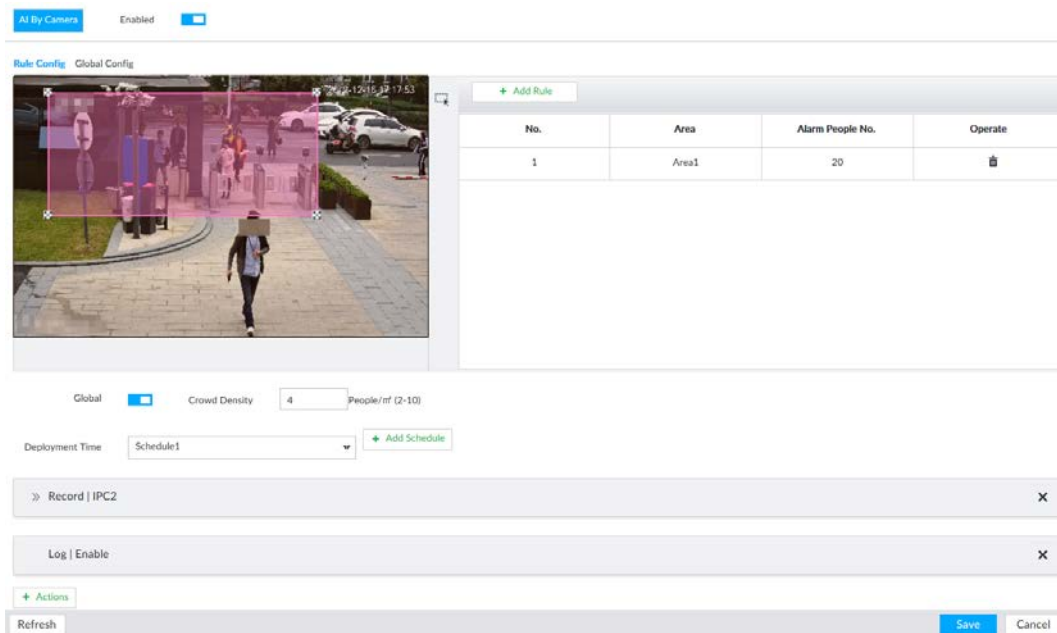

- 2) Drag to adjust the size.
 - 3) Configure alarm threshold. Alarm is triggered when the detected people number reaches the threshold.
- Set global alarm.
- 1) Click , and then drag to adjust the size of the yellow area.
 - 2) Click to enable global detection.
 - 3) Set crowd density. Alarm is triggered when the detected crowd density reaches the threshold.

Step 6 Select a schedule from the **Deployment Time** drop-down list.
The alarm linkage action is triggered only during the scheduled period.



To modify the schedule, click **Add Schedule**.

Step 7 Click **Actions**, and then select an action to be associated to the alarm.

Step 8 Click **Save**.

6.9.3 Live View of Crowd Distribution

On the **LIVE** page, open a view that contains the crowd distribution detection camera.
The video shows people numbers and distribution status in the detection areas in real time. The area frame flashes red when there is an alarm in the area.

Figure 6-134 Live view of crowd distribution



- Right-click on the live video, and then select **Crowd Distribution Map > PIP**. A blue section is displayed, and it shows the crowd distribution status inside the current view.
- Right-click on the live video, and then select **Crowd Distribution Map > Global** to switch to the distribution view. The view indicates crowd density and people heads in different colors.

6.10 Call Alarm

An alarm is triggered when the system detects a person calling. To configure call alarm, set call detection rules for the visible light channel of a thermal camera.



Call alarm is only available with AI by Camera.

6.10.1 Enabling AI Plan

Enable the corresponding AI plan before using AI by camera functions. For details, see "6.2.1 Enabling AI Plan".

6.10.2 Configuring Call Alarm

Configure call alarm rules.



The call alarm is only available with thermal cameras.



- Step 1** Click  or click  on the configuration page, and then select **EVENT**.
- Step 2** In the device tree, select the visible light channel of a thermal camera.
- Step 3** Select **AI Application > Call Alarm**.
- Step 4** Click  next to **Enabled** to enable rule configuration.

Figure 6-135 Configure call alarm



Step 5 Click and drag to adjust the size of the detection area (yellow area).

Step 6 Set **Sensitivity** and **Min Duration**.

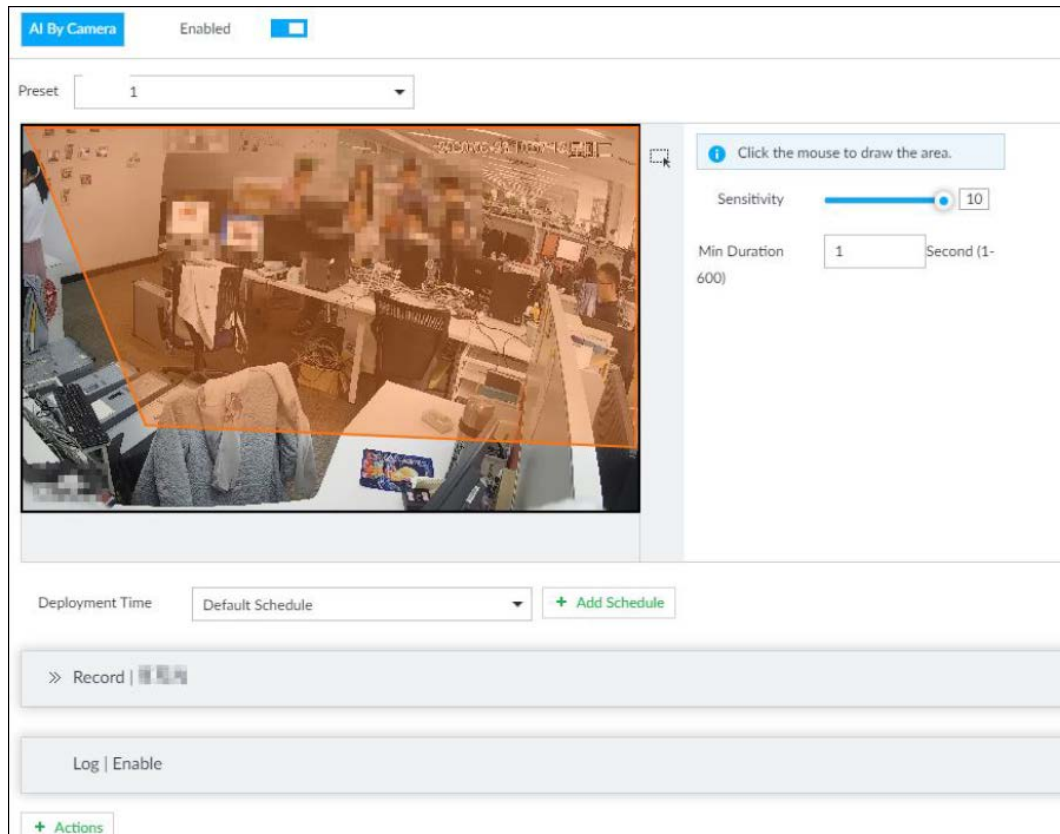
- **Sensitivity**: The higher the **Sensitivity** is, the easier the call action is detected.
- **Min Duration**: The minimum duration the call action lasts. If the call action still lasts after the **Min Duration**, the system will trigger an alarm.

Step 7 Click **Deployment Time** to select a schedule from the drop-down list.

System triggers corresponding alarm actions only during the alarm deployment period.



You can select an existing schedule from the **Deployment Time** drop-down list. You can also add a new schedule. For details, see "8.8.4 Schedule".

Step 8 Click **Action** to set alarm action. See "8.4.1 Alarm Actions" for detailed information.

6.10.3 Live View of Call Alarm

Log in to PCAPP. On the **LIVE** page, open a view that contains the call alarm detection channel. The call action is highlighted in red when the alarm is triggered.

Figure 6-136 Live view of call alarm

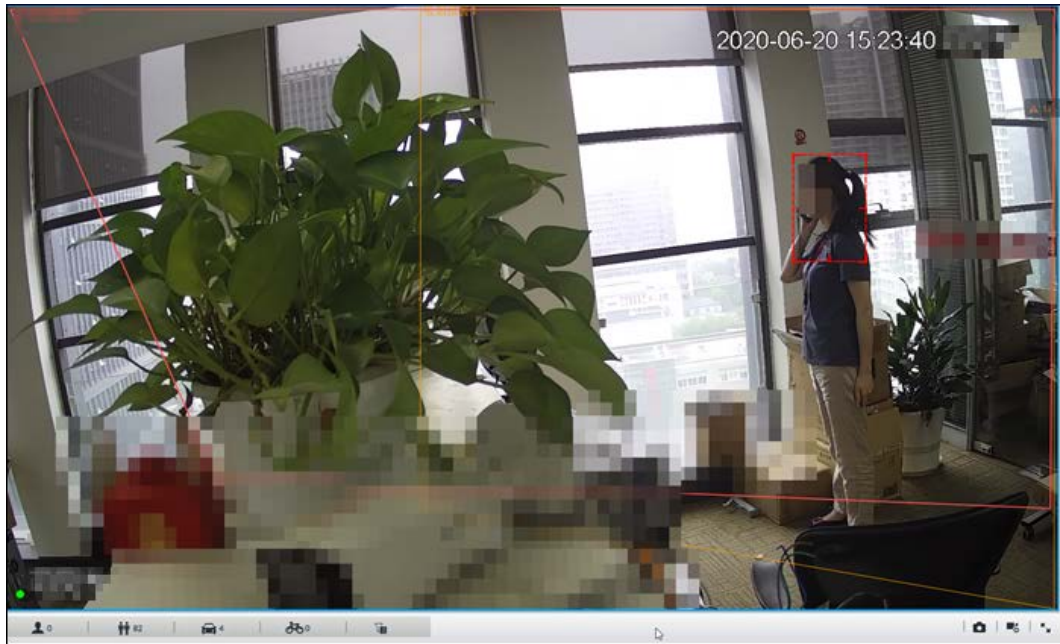

6.10.4 Call Alarm Search

Search for videos or images of call alarm.

Step 1 On the **LIVE** page, click **+**, and then click **Search**.

Figure 6-137 Search

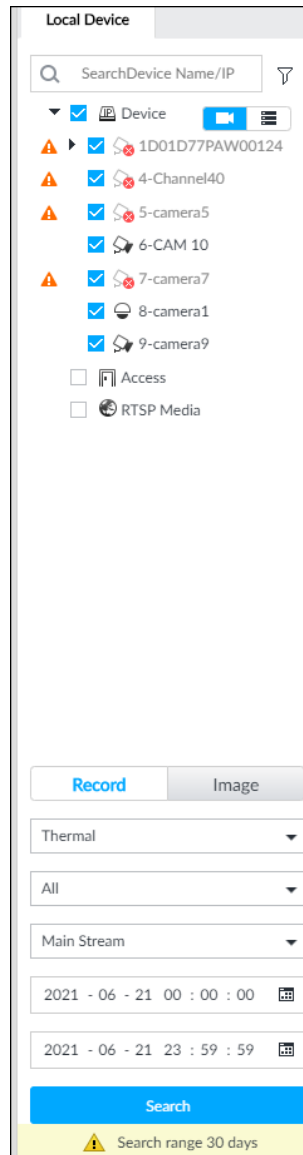

Step 2 Select one or more devices.

Step 3 Set search parameters.

- Record
 - 1) Select **Thermal** as record type.
 - 2) Select **Call Detection** as detection type.
 - 3) Select a stream type.
 - 4) Set time period.
- Image
 - 1) Select **Thermal** as record type.
 - 2) Select **Call Detection** as detection type.
 - 3) Set time period.

Step 4 Click **Search**.

6.11 Smoking Alarm

An alarm is triggered when the system detects a person smoking. To configure smoking alarm, set

smoking detection rules for the visible light channel of a thermal camera.



Smoking alarm is only available with AI by Camera.

6.11.1 Enabling AI Plan

Enable the corresponding AI plan before using AI by camera functions. For details, see "6.2.1 Enabling AI Plan".

6.11.2 Configuring Smoking Alarm

Configure smoking alarm rules.

Step 1 Click or click on the configuration page, and then select **EVENT**.

Step 2 In the device tree, select the thermal channel of a thermal camera.

Step 3 Select **AI Application > Smoking Alarm**.

Step 4 Click next to **Enabled** to enable rule configuration.

Figure 6-138 Configure smoking alarm

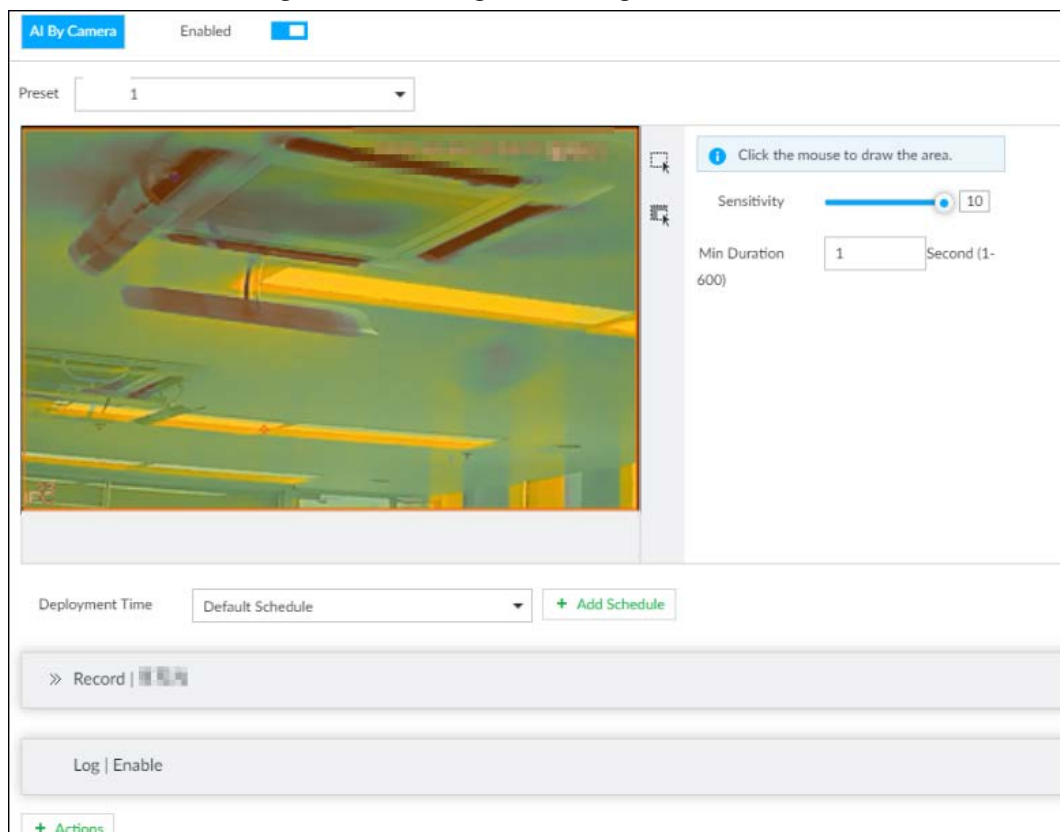

Step 5 Set **Sensitivity** and **Min Duration**.

- Sensitivity: The higher the **Sensitivity** is, the easier the call action is detected.
- Min Duration: The minimum duration the call action lasts. If the call action still lasts after the **Min Duration**, the system will trigger an alarm.

Step 6 Click **Deployment Time** to select a schedule from the drop-down list.

System triggers corresponding alarm actions only during the alarm deployment period.



You can select an existing schedule from the **Deployment Time** drop-down list. You can also add a new schedule. For details, see "8.8.4 Schedule".

Step 7 Click **Action** to set alarm action. See "8.4.1 Alarm Actions" for detailed information.

Step 8 Click **Save**.

6.11.3 Live View of Smoking Alarm

Log in to PCAPP. On the **LIVE** page, open a view that contains the smoking alarm detection channel. The smoking action is highlighted in red when the alarm is triggered.

7 General Operations

This chapter introduces general operations such as live view, playback, alarm, AI functions, and IVS.

7.1 Live and Monitor

After you have logged in, the **LIVE** page is displayed.



Point to the middle of video window and the left column.  is displayed. Click the icon if you need to hide the left column.

Figure 7-1 Live (1)



Figure 7-2 Live (2)

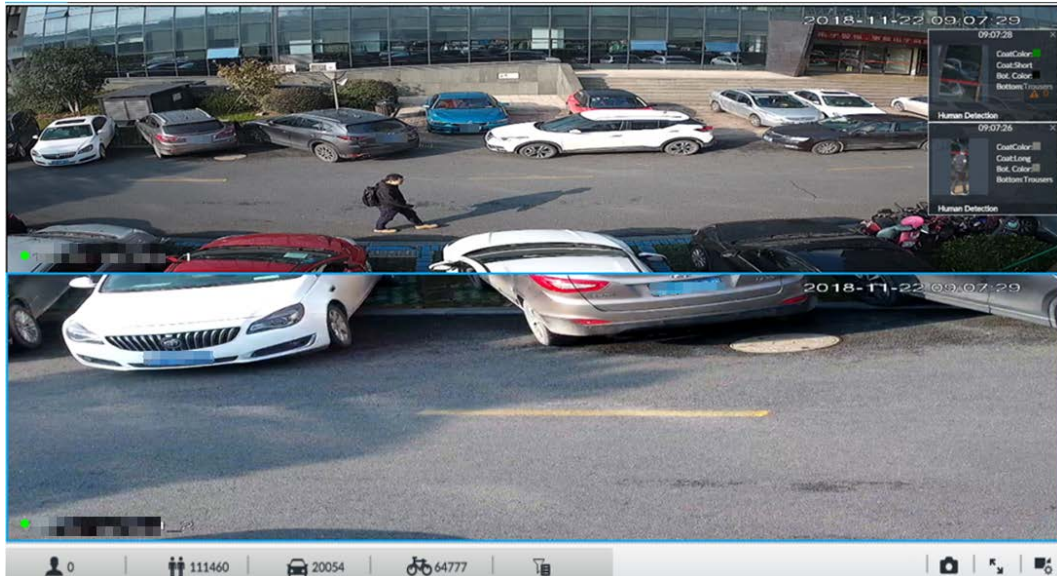

Table 7-1 Live page description

No.	Description
1	View zone. Displays the created view and view group. See "7.1.1 View Management" for detailed information.
2	Resource pool. Displays the added remote device list.
3	PTZ zone. It is to control the PTZ. See "7.1.3 PTZ" for detailed information.
4	Smart preview icons. View face statistics, person statistics, IVS statistics and AI display.
5	Video play window. See "7.1.1.2 View" window for detailed information.
6	<ul style="list-style-type: none"> Click to take snapshot. Click for full-screen view. Click to go to the VIDEO RECORDING page for recording configuration.

7.1.1 View Management

View is composed of video images of several remote devices. Go to the view panel at the top left corner of the **LIVE** page to view or call the view.

- System has created views group by default. Create view or view group under the View.
- Double-click the view or drag the view to the play panel on the right side. Device begins playing the real-time video from the remote device.
- Click to select views and its sub-node.

Figure 7-3 View

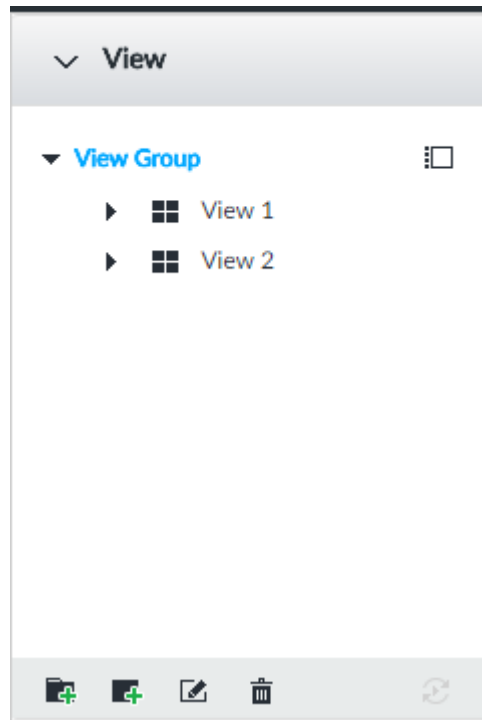

7.1.1.1 View Group

View group is a group of views. The view group allows you to categorize and manage view. It is easy for you to search and find the view. Create view or view group under the View.



- Device supports maximum 100 view groups.
- The views hierarchy shall not be more than 2. For example, after you create View Group 1 under View, you can create a sub-level View Group 2 under View Group 1. However, you cannot create sub-level group under View Group 2.

7.1.1.1.1 Creating View Group

Step 1 Follow the steps listed below to create a view group.

- Click **View Group** or a created view group, and then click .
- Right-click **View Group** or a created view group, and then select **Add View Group**. System creates one view group.

Figure 7-4 Create view group



Step 2 Set view group name.

- The view group name ranges from 1 to 64 characters. It can contain English letters, numbers and special characters.
- View group is to classify or category different view groups. We recommend the view group name shall be easy to recognize.

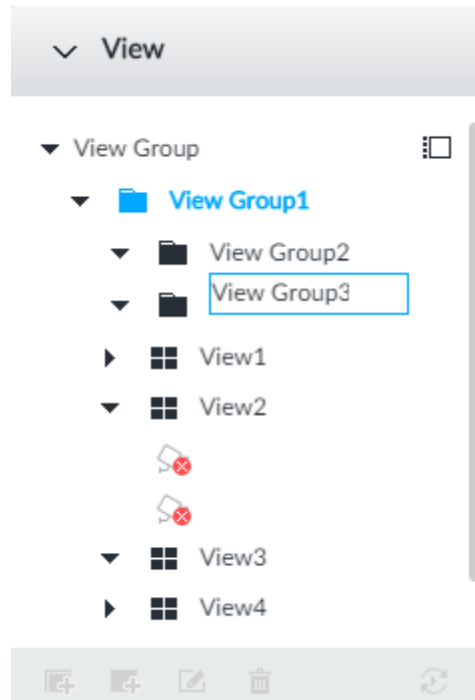
Step 3 Click any black space on the page.

7.1.1.1.2 Operation

After creating view group, view group can be renamed or deleted.

Figure 7-5 Rename

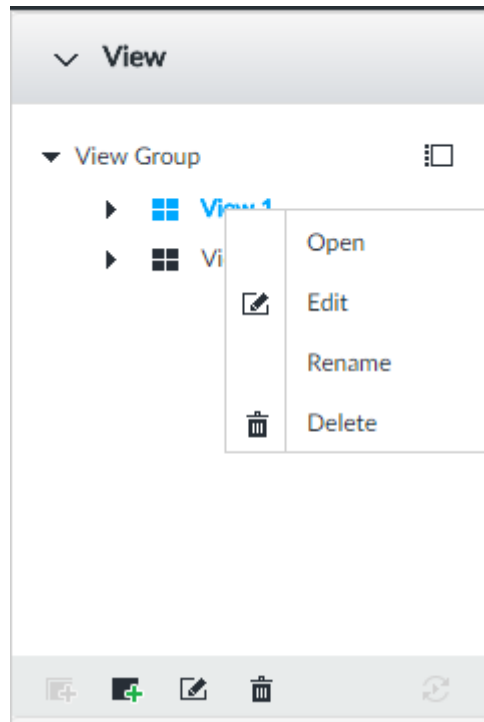

Table 7-2 View group

Name	Operation
Rename view group	<ul style="list-style-type: none"> • Select a view group and then click . Set view group name and click any spare panel. • Right-click view group and select Rename. Set view group name and click any spare panel.
Delete View group	<p> Please be advised that once you delete view group, all views under current view group will be deleted at the same time.</p> <ul style="list-style-type: none"> • Select view group and click . • Right-click view group and then select Delete.

7.1.1.2 View

View is a video component of several remote devices. You can drag several remote devices to the same view and when view function is enabled, you can view the real-time video from several remote devices at the same time.

7.1.1.2.1 Creating View

Create view is to add several associated remote devices to the same View. It is easy to view the real-time video from several remote devices at the same time.

Prerequisites

Remote device has been added. See "5.4.2 Adding Remote Device" for detailed information.

Procedure



- Step 1** Follow the steps listed below to create view.
- Select a view group and then click , select **Add view**.
 - Right-click a view group, select **Add view**.

Figure 7-6 Edit view (1)

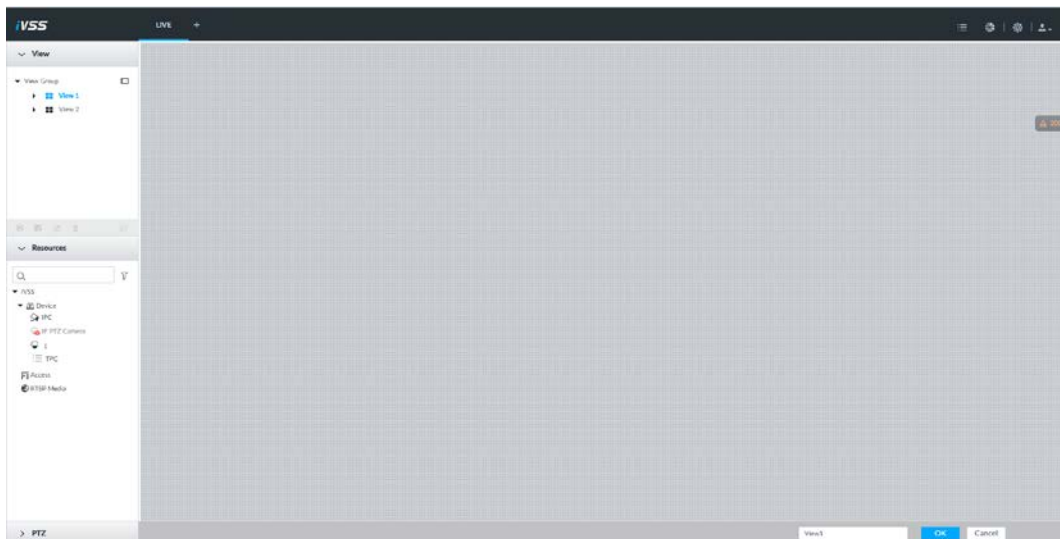

- Step 2** Double-click a remote device in resource pool, or drag the remote device to the right panel.

After one remote device is added, layout grid is displayed.

- Each layout grid supports one remote device. If you want to add several remote devices, drag the rest remote device to other idle layout grid.
- If the layout grid has added the remote device, drag another remote device to current grid is to replace the original one.
- Point to the orange panel (such as ) of the view window, click the view window and then drag after you see the arrow icon. It is to adjust view window size.



- Device automatically creates the view grids amount according to the selected remote device amount. Device supports maximum 36 view windows.
- The view window fills in the whole layout grid by default. Right-click to select **Original Scale > ON**, and turn on the **Original Scale**. The device automatically adjusts view window size according to resolution of remote device.
- When adjusting view window position, drag the view window to the layout grid of the green background color. You cannot drag the view window to the grid of red background color.

Figure 7-7 Edit view (2)

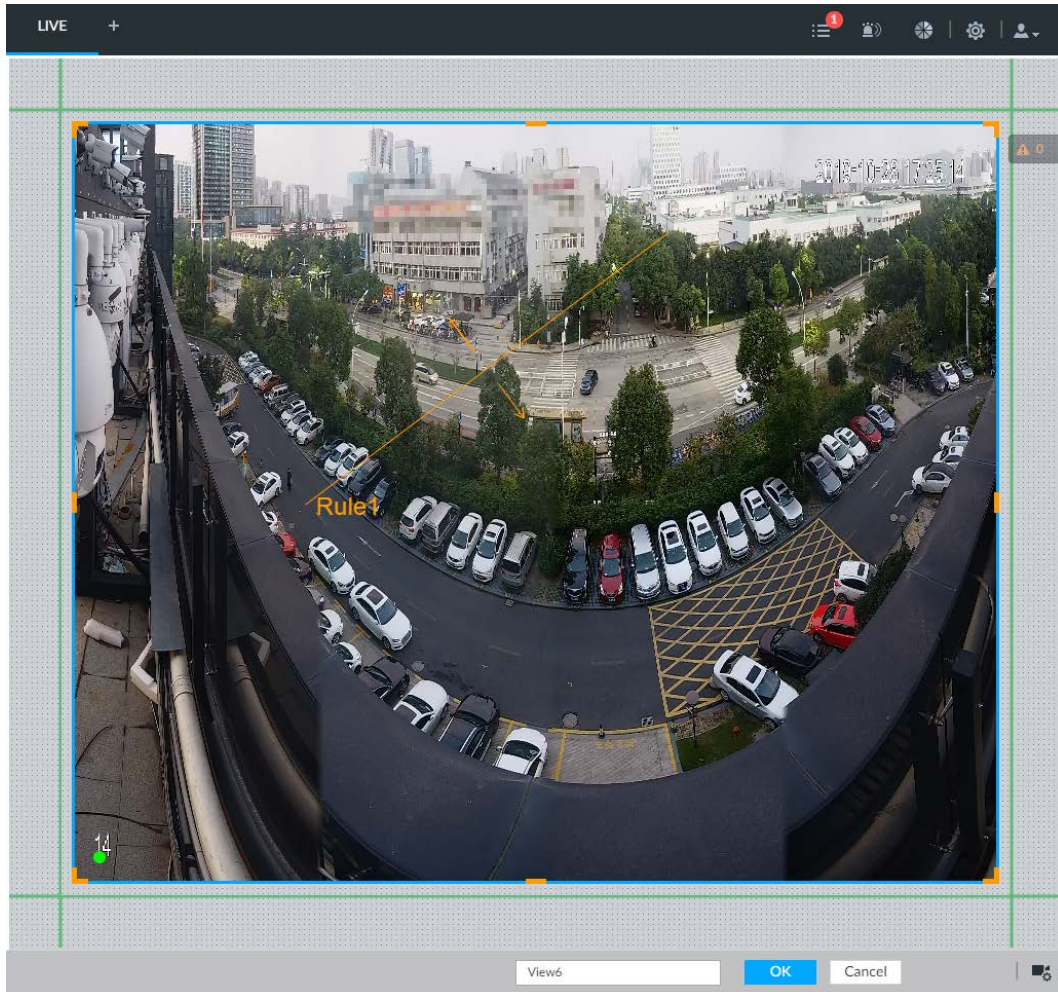

Step 3 Set view name.

The view name ranges from 1 to 64 characters. It can contain English letters, number and special character.

Step 4 Click **OK** to save the configuration.

Device pops up a prompt of **Successfully operated**.

Related Operations

After creating view, view can be edited, enabled, renamed or deleted.

Table 7-3 View

Name	Operation
Edit View	Edit remote device in the view, window layout and view name. See "7.1.1.2.2 Editing View" for detailed information.
Enable view	After enabling view, view real-time image of remote device in the view. See "7.1.1.2.3 Enabling view" for detailed information.
Rename view	<ul style="list-style-type: none"> Select a view group and then click . Set view group name and click any spare panel. Right-click view and select Rename. Set view name and click any spare panel.



Name	Operation
Delete view	<ul style="list-style-type: none"> • Delete: Select a view and then click , or right-click view and then select Delete. • Batch delete: Click , select views you want to delete and then click .

Figure 7-8 Menu



7.1.1.2.2 Editing View

In edit view mode, you can perform the following functions:

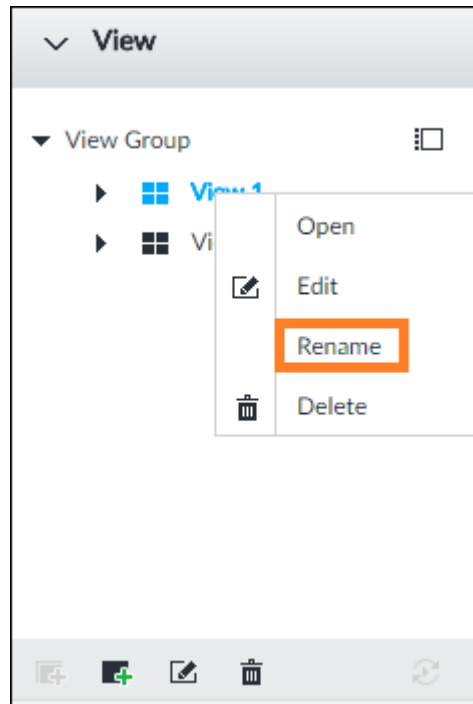
- Add, or delete the remote device on the view.
- Adjust the view grid display.
- Modify view name.

Step 1 Right-click a view and then select **Edit**.

Figure 7-9 Edit view

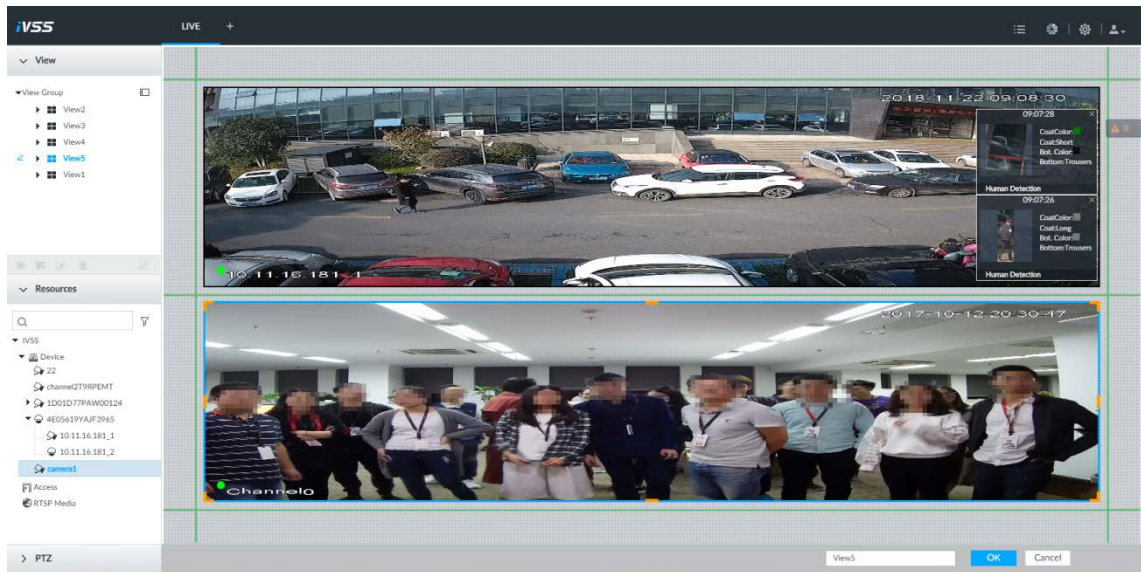

Step 2 Edit view as you require.

- Add remote device: Double-click remote device in the resource pool, or drag the remote device to the free layout grid on the right panel.
- Delete remote device: Point to window on the right, and click at the top right corner.
- Move window position: Select and hold on a view window, move it to the proper position and release mouse.
- Change window position: Select and hold on one view window and then drag to another view window.
- Change window size: Move your mouse to the orange panel on the window (such as). Hold and drag the view window after you see the arrow icon.
- Modify view name: Set view name on .



When adjusting view window position, drag the view window to the layout grid of the green background color. You cannot drag the view window to the grid of red background color.

Step 3 Click **OK** to save the configuration.

7.1.1.2.3 Enabling view

Right-click the view and select **Open**, or double-click view to open the view window.

Figure 7-10 View window

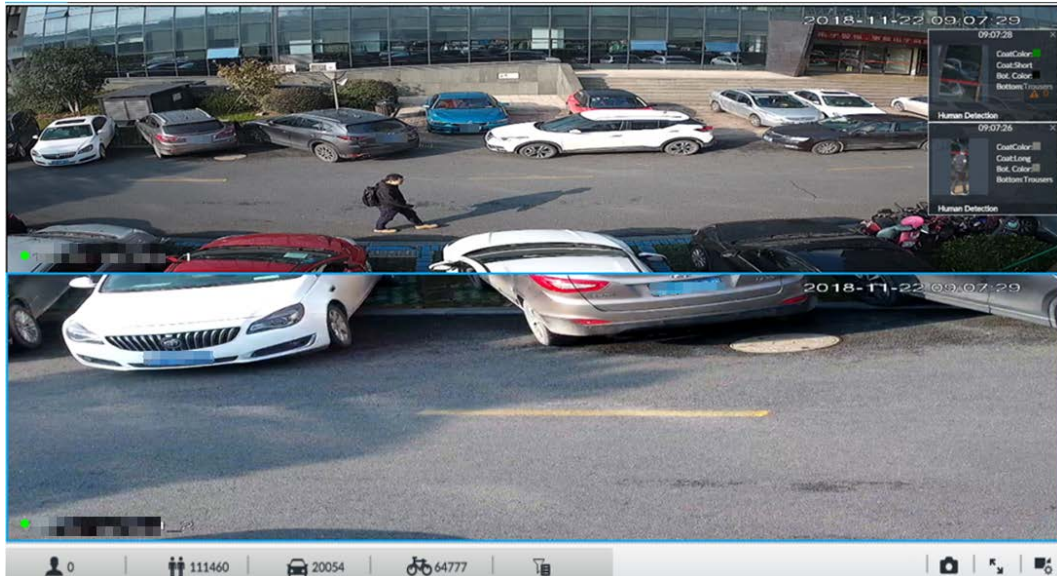



When enabling the view, you can change video position, zoom video window.



- When adjusting view window position, drag the view window to the layout grid of the green background color. You cannot drag the view window to the grid of red background color.
- Point to view window. Window task column is displayed to snapshot, enable record and turn off view window. See "7.1.1.3.1 Task Column" for detailed information.
- Right-click view window, you can switch bit streams, set digital zoom. See "7.1.1.3.2 Shortcut Menu" for detailed information.

Table 7-4 View function

Name	Description
Exchange window position	<p>Press one view window and drag it to another view window, it is to exchange these view window position.</p> <p>The exchanging window position operation is valid only once. Disable and then enable view again, the view window restores original position. If you want to change view window position permanently, go to the view edit mode to set. See "7.1.1.2.2 Editing View" for detailed information.</p>
Zoom in video window	<ul style="list-style-type: none"> • Once current view window amount is too much (more than 9), click one view window, device displays current view window at the center of the window in the zoom in mode. Click any other blank position, you can view window restores original size. • Double-click a view window, device displays view window at one window. Double-click view window again or click any blank position, the view window restores original size.

Name	Description
Add view window	In the resource pool, double-click the remote device or drag the remote device to the right panel, you can add remote device to current view. Drag the remote device to the view window to replace the original remote device.  The modified view layout is valid only for once if you do not click OK button. Close and enable view again, the view layout restores original layout.
Close view window	Point to one view window, click  to close the view window. Close view window, device automatically adjusts view layout according to the rest remote device amount and play panel free space.

7.1.1.3 View Window

Right-click the view, select **Open**, or double-click view to open the view window.

Figure 7-11 View window

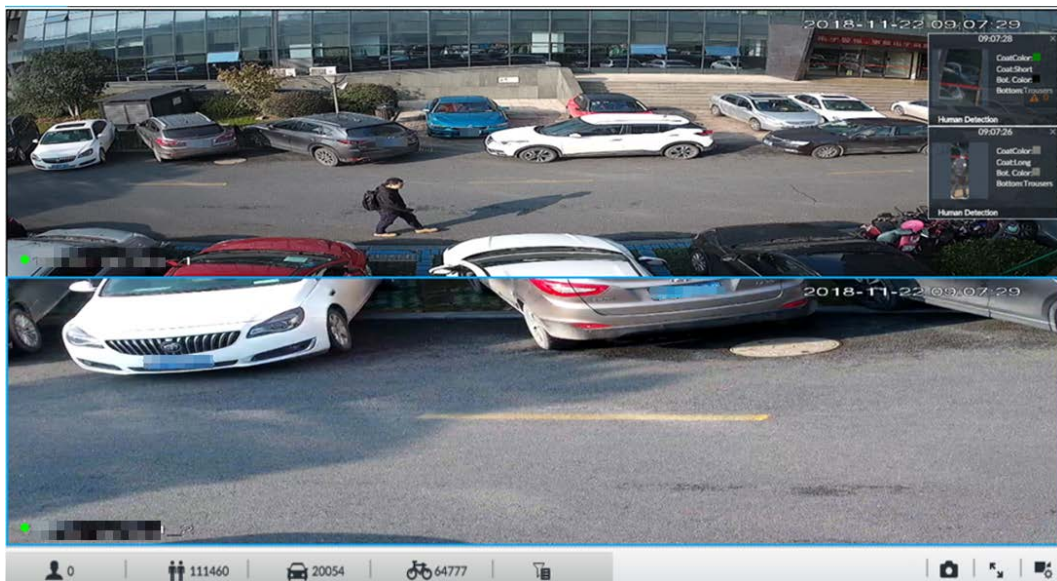

7.1.1.3.1 Task Column

Point to view window. The icons are displayed.

Figure 7-12 View window

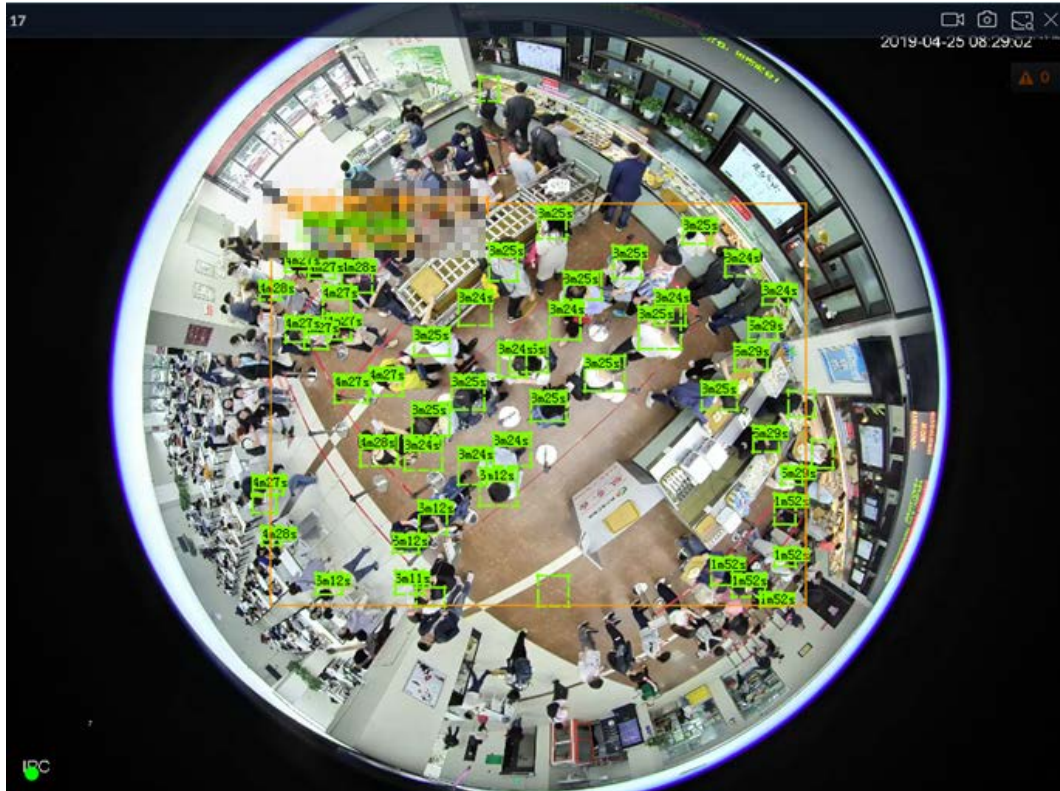







Table 7-5 Window task column

Name	Description
Start Instant Video Recording	<p>Click  to start recording manually. Now the icon becomes . Click  to stop recording.</p> <p>System stops recording according to the instant record length settings if you do not click  again to stop.</p> <p>On different interfaces, recording storage path varies.</p> <ul style="list-style-type: none"> ● Local <ul style="list-style-type: none"> ◇ When USB storage device is connected, recordings are saved in USB storage device. ◇ Otherwise, the recordings are saved in the device. Query or export manual recording by playback control. ● PCAPP <p>Default storage path of recording is C:/Program Files (x86)/iVSS/video. Set storage path.</p>

Name	Description
Snapshot	Click  to snapshot. At different interfaces, snapshot storage path varies. <ul style="list-style-type: none"> ● Local <ul style="list-style-type: none"> ◇ When USB storage device is connected, snapshots are saved in USB storage device. ◇ Otherwise, the snapshots are saved in the device. Query or export the snapshots by playback control. ● PCAPP Default storage path of snapshot is C:/Program Files (x86)/iVSS/pictures. Set storage path.
Search by image	Take snapshots of face or human during live view, and use the snapshot to search for similar targets.
Close view window	Click  to close view window.

7.1.1.3.2 Shortcut Menu

Right-click the view window. The shortcut menu is displayed.

Figure 7-13 Shortcut menu

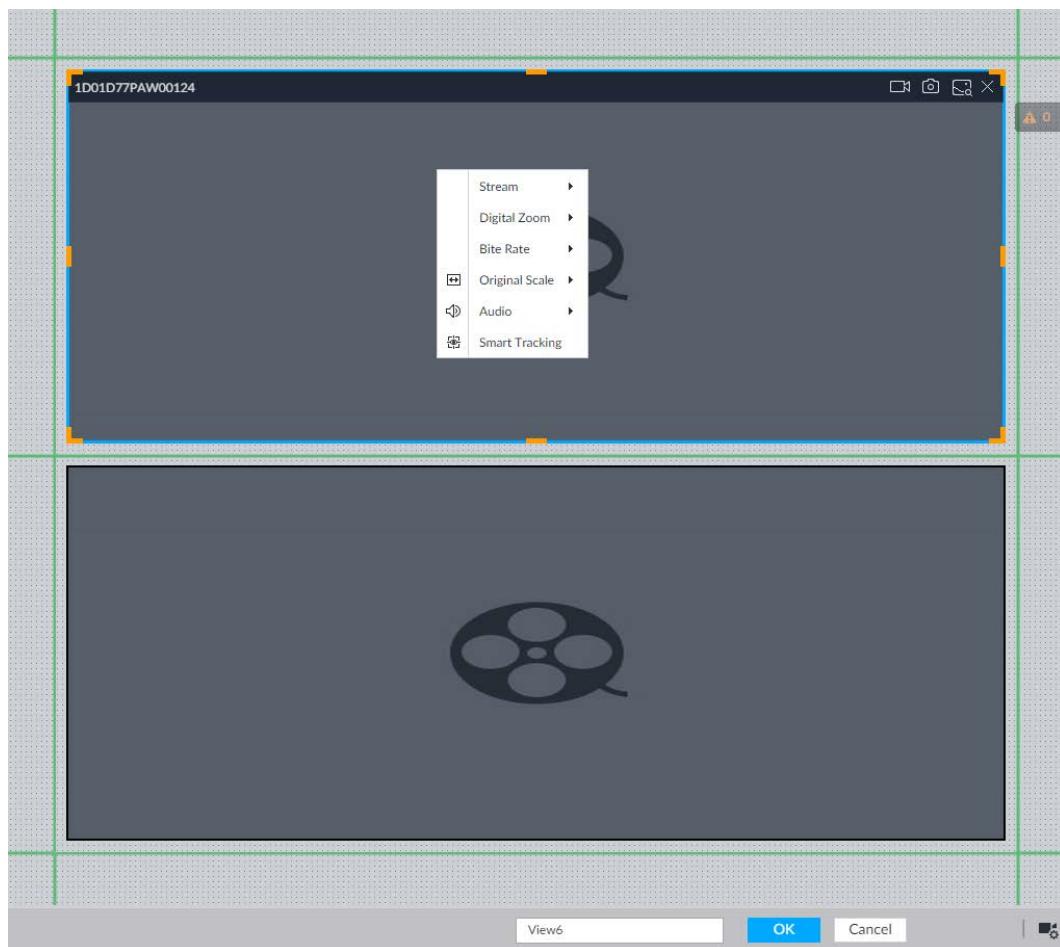

Table 7-6 Shortcut menu



Parameters	Description
Stream	Set current window stream. It includes main stream/sub stream 1/sub stream 2.
Digital Zoom	Set digital zoom. Zoom in one part of live image to view details.
Bit Rate	Displays real-time bit rate on the window or not.
Original Scale	Set video window scale. <ul style="list-style-type: none"> ● ON: System automatically adjusts video window scale according to the resolution. ● OFF: System automatically adjusts video window scale according to the remote device amount and the free space on the playback panel.
Audio	Set audio output. It includes audio 1, audio 2, mixing and off.
Fisheye Dewarp	Set installation methods and display modes of fisheye cameras.  This function is only available on fisheye camera.
Smart Tracking	Intelligently track targets.  This function is only available on the multi-sensor panoramic camera + PTZ camera.

Figure 7-14 View window



7.1.1.3.3 Digital Zoom

The digital zoom function allows you to zoom in a specified zone to view the video details.

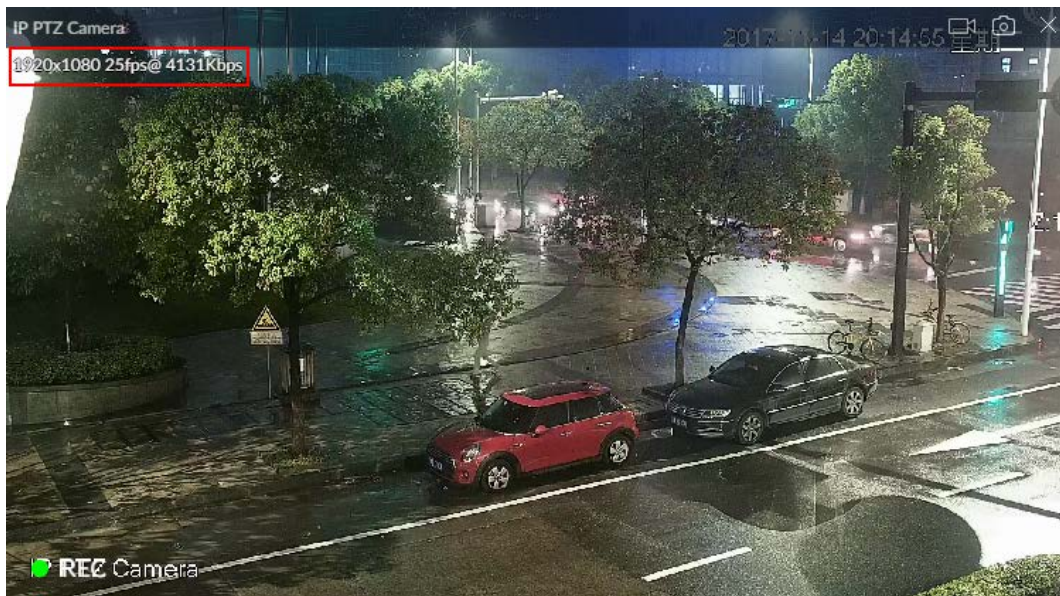
After enabling view, right-click **Digital Zoom** > **ON**. Select a zone in view window, and the selected zone will be zoomed in.

- In zoom in status, press any position on the video window and then drag, you can view the zoom in effect of other zones.



- Select a zone you want to zoom in on the video window again, system zooms in the zone at the larger rate.
- Right-click and then select **Digital Zoom > OFF**, it is to cancel zoom in effect. The video restores original effect.

Figure 7-15 Digital zoom



7.1.1.3.4 Searching by Image

Draw a frame on the video to select an image than contains targets, and then use the images to search for similar faces or human bodies.

- Step 1** Click  at the upper-right corner of the video.
- Step 2** Draw a frame on the video to select an image than contains target faces or humans.
- Point to the frame, and then you can move its position.
 - Drag  to adjust the size.
- Step 3** Click Search by Picture.
You are prompted to select a type of target.
- Step 4** Select a target type.
- Step 5** Click **OK**. The system starts searching all the cameras for records within a week.

7.1.1.3.5 Fisheye Dewarp

Set the installation method and display mode of fisheye cameras.



This function is available on select models.



- Installation method: Select the installation method according to the actual situation.
- Display mode: Select the display mode of live view.

Figure 7-16 Fisheye dewarp













Step 1 Right-click on the live video, and then select **Fisheye Dewarp**.

Step 2 Select an installation method.

- Click  to select ceiling mount.
- Click  to select wall mount.
- Click  to select ground mount.

Step 3 Select a display mode.

Table 7-7 Display mode

Installation Method	Display Mode	Description
Ceiling/wall/ground mount		The original fisheye image.
Ceiling/ ground mount	 1P+1	Corrected 360° panoramic image + section images.
	 2P	2 corrected 180° images, which consist the 360° panoramic image.
	 1+3	Original image + 3 section images.
	 1+4	Original image + 4 section images.
	 1P+6	Corrected 360° panoramic image + section images.
	 1+8	Original image + 8 section images.
Wall mount	 1P	Corrected 180° image from left to right.
	 1P+3	Corrected 180° image + 3 section images.
	 1P+4	Corrected 180° image + 4 section images.
	 1P+8	Corrected 180° image + 8 section images.

Step 4 Click OK.

7.1.1.3.6 Smart Tracking

Track targets manually or automatically. This function is only available on the multi-sensor panoramic camera + PTZ camera.



Make sure that the linked tracking function has been enabled.

Step 1 Right-click on the live video, and then select **Smart Tracking > ON**.

Figure 7-17 Smart tracking

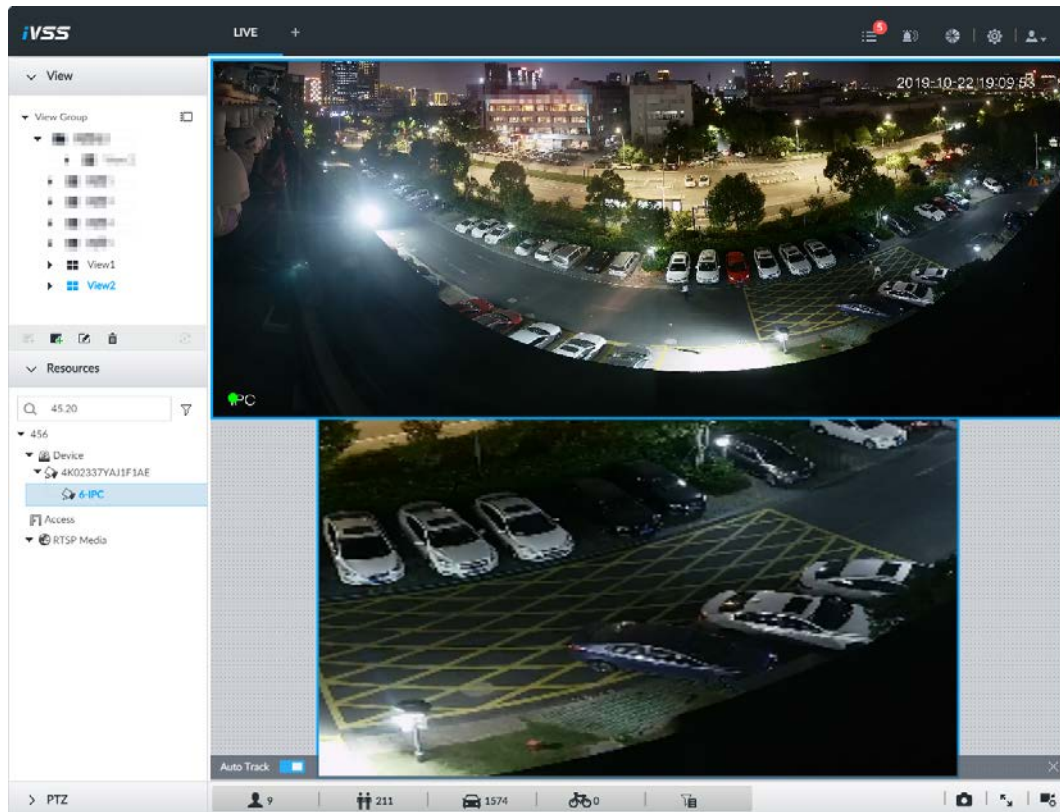

Step 2 Select the tracking method.

- **Manual positioning:** Click a spot or select a zone on the bullet camera video, and then the PTZ camera will automatically rotate there and zoom in.
- **Manual tracking:** Click or select a target on the bullet camera video, and then the PTZ camera automatically rotates and tracks it.
- **Automatic tracking:** The tracking action is automatically triggered by alarms according to the pre-defined rules.

7.1.1.3.7 Thermal

On the **LIVE** page, a thermal camera has 2 channels: Visible light channel and thermal channel. Select the thermal channel, point to any position on the live video, and then you can view the real-time temperature of the position.

Figure 7-18 Thermal



7.1.1.3.8 Talk

The Talk function enables voice interaction between the Device and remote devices, improving the efficiency in handling emergency events.

Step 1 Log in to PCAPP.

Step 2 Open a view on the **Live** page.

Figure 7-19 Talk



Step 3 Click  at the upper-right corner of the view window to enable the Talk function. Click again to disable the function.

7.1.2 Resources Pool

The resource pool displays the added remote device list. The system automatically divides into groups according to device type.

Figure 7-20 Resources pool

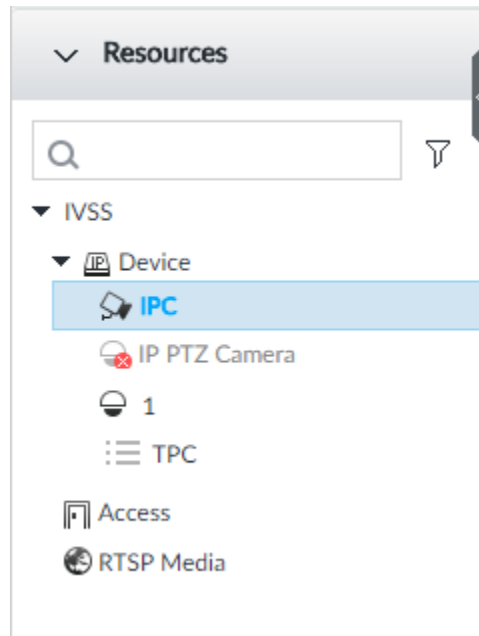

Table 7-8 Resources pool description

Operation	Description
Search device	Input key words at <input type="text"/> , device displays the corresponding remote devices. Support fuzzy search.
Filter device	Click and then select all, online, offline. It is to filter the disqualified remote device.
View device status	Display remote device status on the resources pool. <ul style="list-style-type: none"> • If the remote device name and icon is black, it means the remote device is online. For example, IP PTZ Camera. • If the remote device name and icon is gray, it means the remote device is offline. For example, IPC. • If there is an icon before the remote device, it means remote device is abnormal, alarming, and so on. Point to , to view the detailed information.

Operation	Description
Mouse Operations	<ul style="list-style-type: none"> ● Point to the remote device name, you can view remote device IP address and port number. ● On the device list, click one remote device and then press Ctrl, click other remote device, you can select several remote devices at the same time. ● On the device list, select one remote device and then press Shift, click other remote device, select current two remote devices and all remote devices listed between them. ● Right-click a remote device to connect to disconnect it. ● Double-click remote device or drag the remote device to the view window on the right panel, you can enter edit the view interface. See "7.1.1.2.2 Editing View" for detailed information.

7.1.3 PTZ

Set PTZ functions and perform PTZ control so the PTZ camera can rotate accordingly to monitor all directions.



The PTZ functions might vary depending on the device models.

Log in to PCAPP. On the **LIVE** page, PTZ is displayed at the lower-left corner.



The following figure for reference only. The grey button means current function is null.

Figure 7-21 PTZ

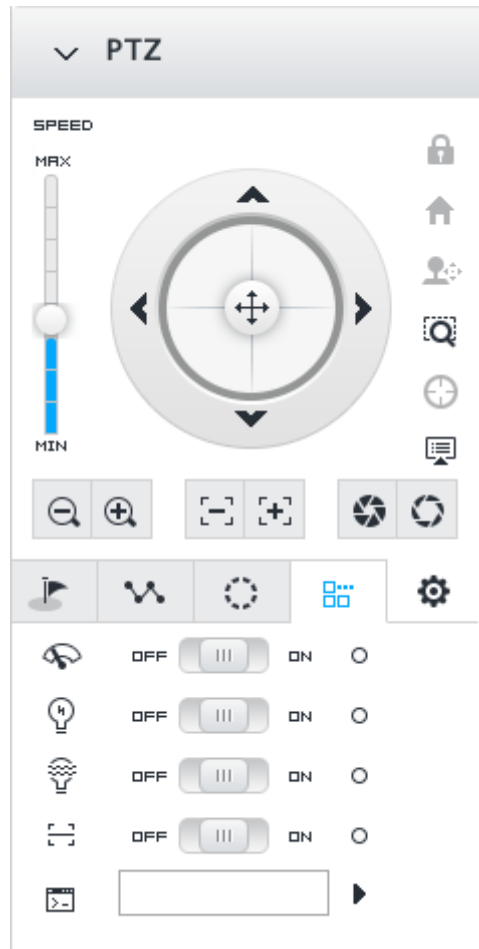























Table 7-9 PTZ Icons

Icons	Description
	Press and hold on  , and drag it up and down. It is to set PTZ speed. The higher the value is, the faster the PTZ speed is.
	Control PTZ movement in the following ways. <ul style="list-style-type: none"> • Press and hold on  to control PTZ top/bottom/left/right/top left/top right/lower-left/lower-right direction. • Click the arrows to control PTZ direction.
	Click to enable 3D positioning function.
	Click to enable auto focus, and then the camera image becomes focused automatically.

Icons	Description
	Click to enter the PTZ menu mode. For details, see "7.1.3.1 PTZ Menu Settings".
	Zoom. Click to adjust lens zoom rate of the remote device.
	Focus. Click to adjust lens focus of the remote device.
	Iris. Click it to adjust iris size of the remote device.
	Click to use windshield wiper, light, IR and linear scan, auxiliary commands. <ul style="list-style-type: none"> •  : Drag the on/off slider to the left or right to enable or disable windshield wiper. •  : Drag the on/off slider to the left or right to enable or disable the light. •  : Drag the on/off slider to the left or right to enable or disable the IR. •  : Drag the on/off slider to the left or right to enable or disable linear scan. •  : Set the No. of auxiliary functions. Click  to enable the corresponding auxiliary function.
	Click to enter PTZ calling page.  Go to the remote device to set corresponding PTZ function before you call it. <ul style="list-style-type: none"> • Click  to enter the preset page. • Click  to enter the cruise page. For details, see "7.1.3.2.2 Setting a Cruise". • Click  to enter the pattern page. For details, see "7.1.3.2.2 Setting a Cruise".

7.1.3.1 PTZ Menu Settings

Device displays PTZ main menu on the view window. The PTZ main menu enables you to perform camera settings, PTZ settings, system management, and more. You can use the direction and confirm buttons to set the remote device.

Step 1 Log in to PCAPP.

Step 2 Enable view and then select a remote device on the view.

Step 3 On PTZ panel, click  to open the OSD menu.

Figure 7-22 PTZ menu

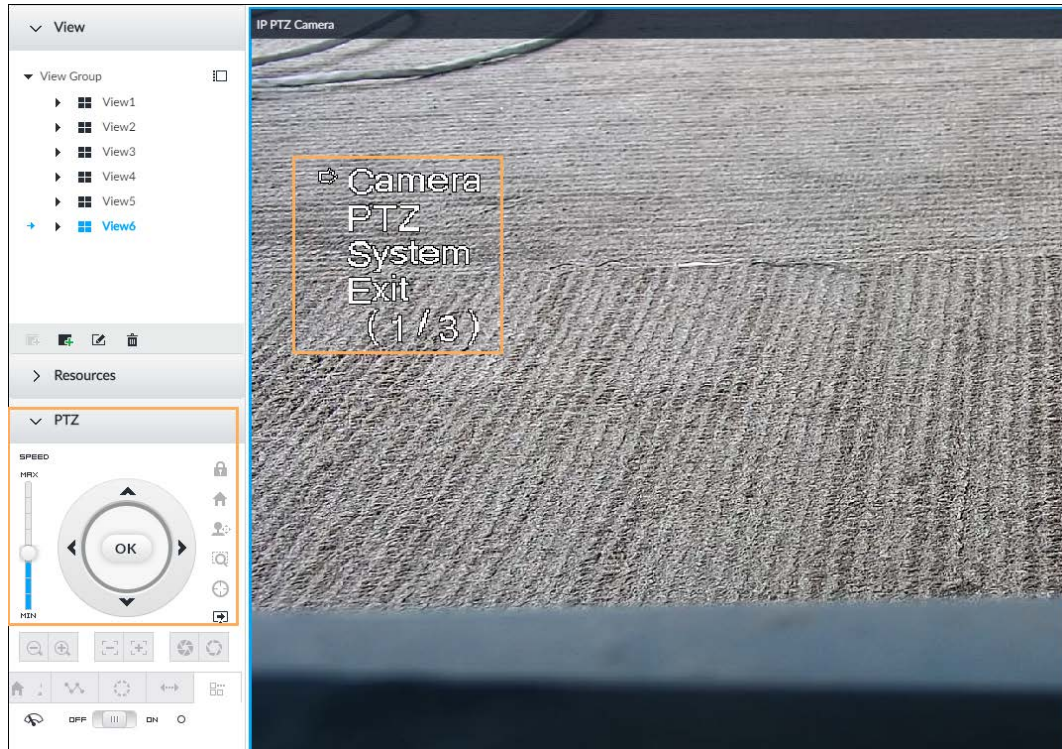

Table 7-10 PTZ menu description

Parameters	Description
Camera	Set remote device image parameters involving picture, exposure, backlight, WB, day and night, focus and zoom, defog, and default.
PTZ	Set remote device PTZ functions such as preset, cruise, scan, pattern, rotation, and PTZ restart.
System	Set remote device PTZ simulator, restore default, manage remote device peripheral device, view remote device software version, PTZ version and more.
Exit	Exit PTZ menu.

Step 4 Set PTZ menu parameters.

- Click ▲ or ▼ to select options .
- Click ► or ◀ to set parameters.
- Click OK to confirm.

Step 5 Click ⏏ to exit PTZ menu mode.

7.1.3.2 Configuring PTZ Functions

Control PTZ device to implement corresponding operations.



The PTZ functions might vary depending on the device models.

7.1.3.2.1 Setting a Preset

A preset is the saved information of a specific position, angle, and focal length of the PTZ camera. You can set a preset so that you can quickly adjust the PTZ to the desired position in the future.

Procedure

- Step 1** Log in to PCAPP.
- Step 2** Select a PTZ camera from the views.
- Step 3** On the PTZ panel, click .

Figure 7-23 Call a preset







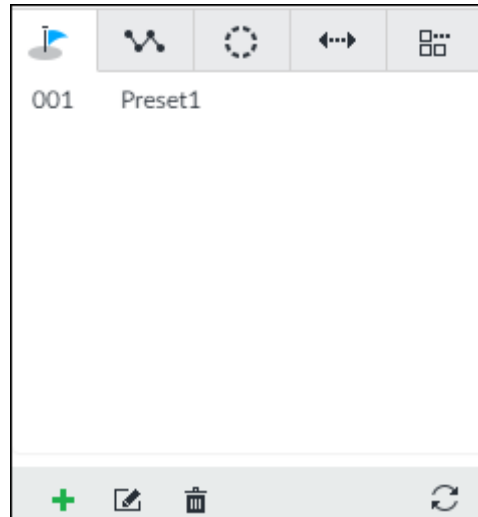



- Step 4** Click the direction icons to rotate the camera to a specific position.
- Step 5** Click , enter the name of the new preset, and then click  to save the preset.

Figure 7-24 Add a preset

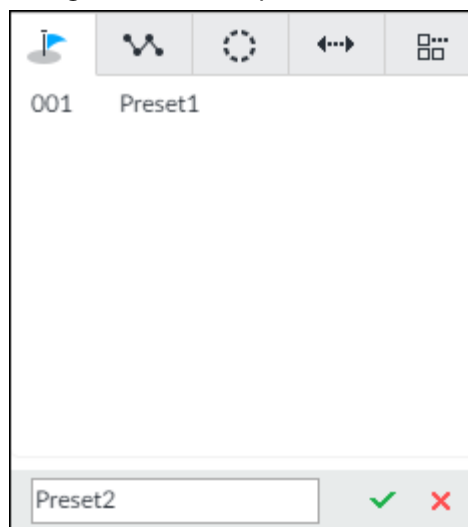

- Step 6** To call the preset, hover over the preset name, and then click .

Related Operations

- Edit a preset:
 - ◇ To edit preset name, double-click the name. The camera rotates to the preset after the double-click.
 - ◇ To modify the preset position, select the preset, and then click , rotate the camera to the desired position, and then click .
 - ◇ To quit, click .
- To delete a preset, select it and then click .
- To refresh presets list, click .

7.1.3.2.2 Setting a Cruise

A cruise is a sequential set of presets. After you call a cruise, the PTZ camera automatically rotates to the presets one by one at the pre-defined interval.

Procedure











- Step 1 Log in to PCAPP.
- Step 2 Select a PTZ camera from the views.
- Step 3 On the PTZ panel, click .
- Step 4 Click , enter the name of the new cruise, and then click  to save.
- Step 5 Click **Add**, select a cruise, and then click .
Repeat this step to add multiple presets into the cruise.



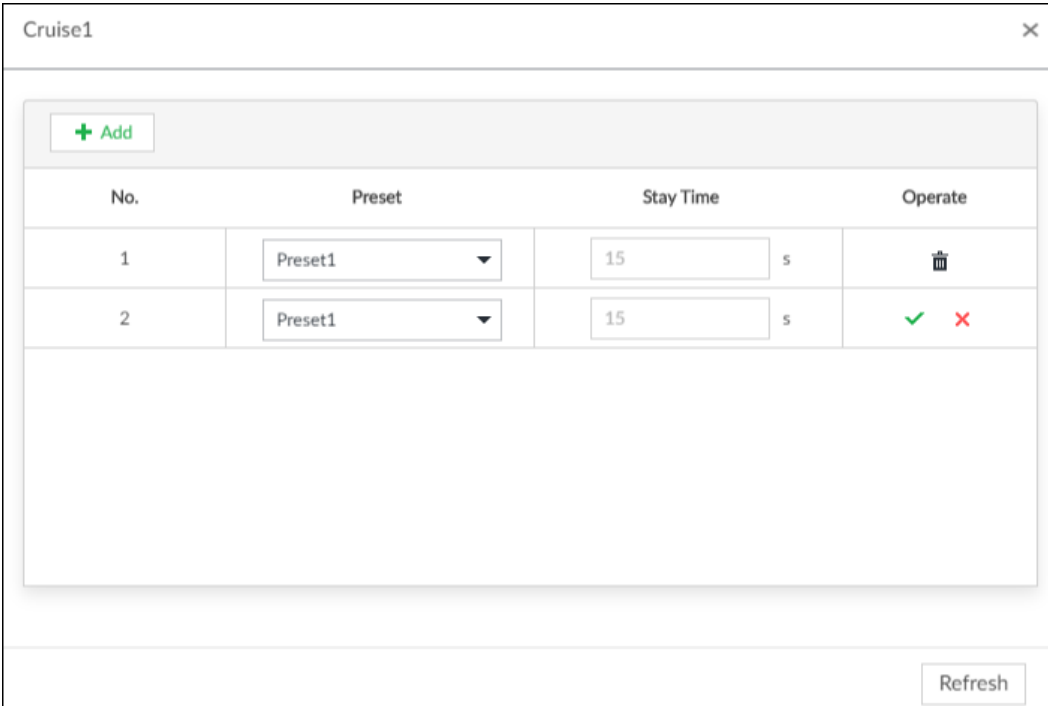

Figure 7-25 Add a cruise



No.	Preset	Stay Time	Operate
1	Preset1	15 s	
2	Preset1	15 s	 

- Step 6 To call the cruise, hover over the cruise name, and then click . To stop the cruise, click .

Related Operations

- Edit a cruise:
 - ◇ To edit cruise name, double-click the name. To quit, click .
 - ◇ To modify the cruise, select the cruise, and then click , modify the settings, and then click .
- To delete a cruise, select it and then click .
- To refresh cruises list, click .

7.1.3.2.3 Setting a Pattern

A pattern is a recorded series of PTZ operations such as pan, tilt, zoom and focusing. You call a pattern to let the camera repeat the corresponding operations.

- Step 1 Log in to PCAPP.

- Step 2** Select a PTZ camera from the views.
- Step 3** On the PTZ panel, click .
- Step 4** To start recording a pattern, double-click on a pattern name, click **Start Record**, perform a series of PTZ actions as desired, and then click **Stop Record**.



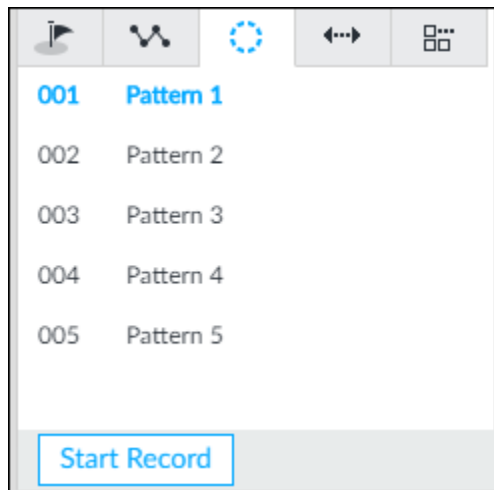

The maximum number of patterns depends on the camera capability. If not limited on the camera, you can config up to 5 patterns by default.

Figure 7-26 Call a pattern







Step 5 To call the pattern, hover over the pattern name, and then click . To stop, click .

- Edit a pattern:
 - ◇ To modify the pattern, select the pattern, and then click . Click **Start Record** and record a new pattern, and then click **Stop Record**.
 - ◇ To quit, click the pattern name.
- To delete a pattern, select it and then click .
- To refresh patterns list, click .

7.1.3.2.4 Setting Linear Scanning

In the linear scanning mode, the camera scans repeatedly to the pre-defined left and then right limit.

- Step 1** Log in to PCAPP.
- Step 2** Select a PTZ camera from the views.
- Step 3** On the PTZ panel, click .
- Step 4** Select a linear scanning, and then double-click it or click . Rotate the PTZ to the left until you think it can be the left limit, and then click  to save; rotate the PTZ to the right limit, and then click .



The maximum number of linear scanings depends on the camera capability. If not limited on the camera, you can config up to 5 scanings by default.

Figure 7-27 Set a linear scanning

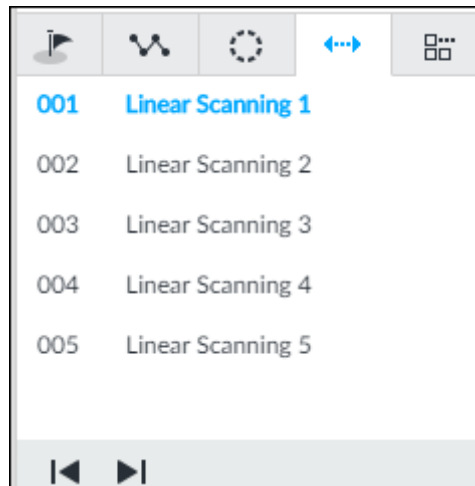

Step 5 To call the linear scanning, hover over the name, and then click . To stop, click .

7.1.3.2.5 Enabling Auxiliary Functions

Enable PTZ windshield wiper, light and IR.

Step 1 Log in to PCAPP.

Step 2 Select a PTZ camera from the views.

Step 3 On the PTZ panel, click .

Figure 7-28 Auxiliary functions

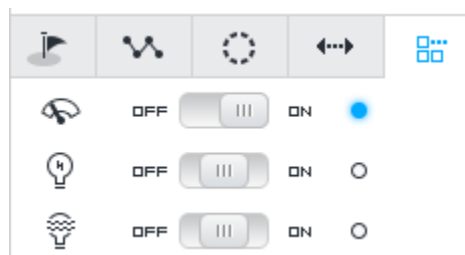

Step 4 Drag the slider to **ON** or **OFF** to enable or disable the function.

- : Windshield wiper. It is available on select models.
- : Light. It is available on select models.
- : IR. It is available on select models.

7.2 Recorded Files

Search or play back the record file or image on the device. At the same time, you can export record file or image to designated storage path.

7.2.1 Playing Back Recorded Video

Search and playback record file according to remote device, record type, and record time.

Step 1 On the **LIVE** page, click and then select **SEARCH**.

Figure 7-29 Search

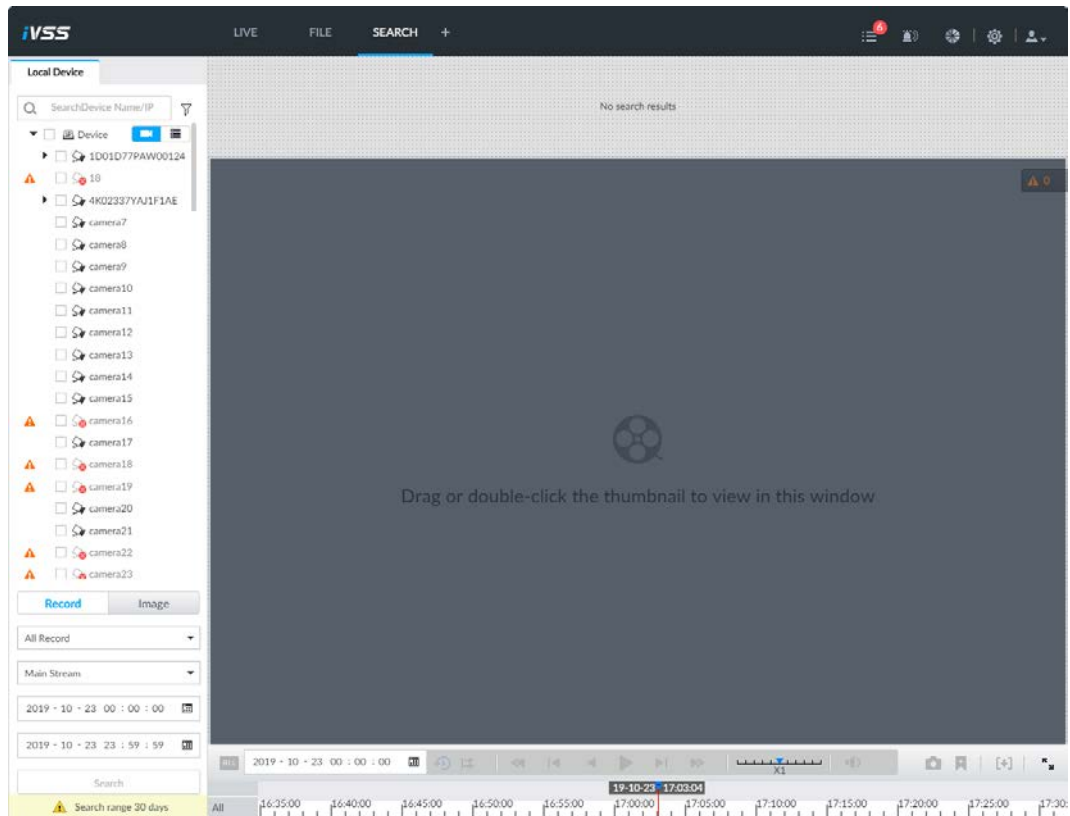

Step 2 Select a remote device, and then click **Record** tab.



Click to display only channels. Click to display channels and devices.

Step 3 Select a record type from among All Record, Manual Record, Video Detect, and IO Alarm and Thermal.

- All record: Search for all records.
- Instant record: Search for instant records.
- Video detect: Search for records of video detection.
- IO alarm: Search for local alarm linkage records.
- Thermal: Search for videos of thermal alarms.

Step 4 Set search time.

- Method 1: Click the date or time on the time column, change time or date value.
- Method 2: Click the date or time on the time column, use the mouse middle button to adjust time or date value.
- Method 3: Click , set date or time on the schedule, click **OK**.

Figure 7-30 Schedule

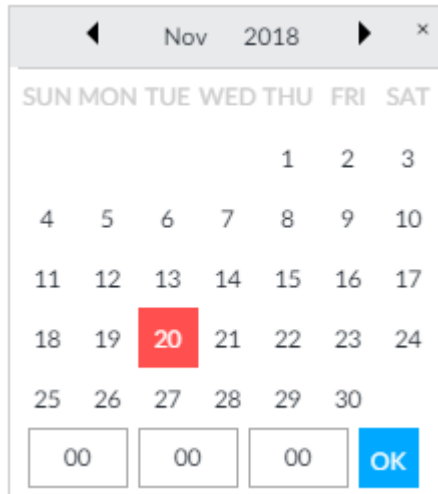

Step 5 Click **Search**.

The record thumbnail is at the top of the remote device, and the time bar displays the record period (green color means there is a record).







- The selected remote device is on the left panel. Click a remote device, and the record file thumbnail is on the right panel.
- Click  or  to move thumbnail list or hide/display the thumbnail.
- Point to the thumbnail, you can view remote device name, record start time, and end time of the corresponding record.
- Point to the thumbnail list. The system displays . Click the icon to hide the thumbnail list. If the thumbnail list is hidden, click  to display the thumbnail list.

Figure 7-31 Search result



Step 6 Drag the thumbnail to the playback window or double-click the thumbnail.

Device begins playing the record.

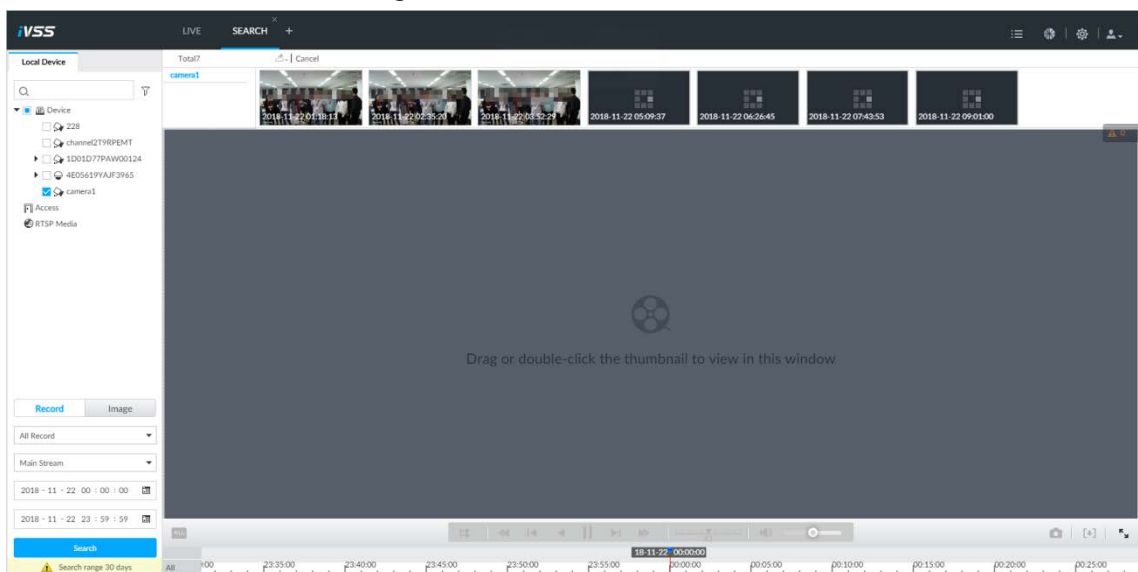

- The playback window amount depends on the thumbnail amount you can drag or

select. System supports maximum 16 windows. System automatically adjusts each window size according to the original scale of playback file.

- The thumbnail with means system is playing record file of current thumbnail.

Figure 7-32 Search

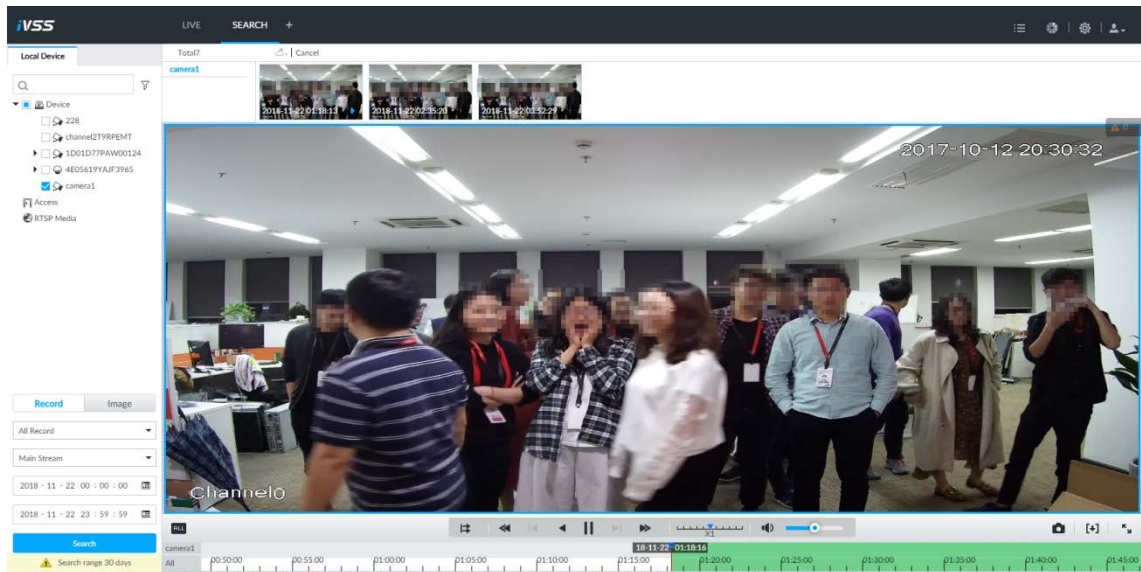







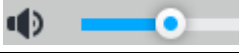







Table 7-11 Search icons description

Signal Words	Description
	Click to synchronize playback mode. You can use the playback control icon to control several windows, such as fast forward/backward at the same time. Click to cancel synchronization operation.
	Set a time period. Click to start playing the videos in the set time period.
	Play back several record files at the same time. Click the icon to switch to time synchronization mode. All other windows play the video file of the same time of current window. Click to cancel time synchronization. Click , system enables synchronization operation function. If you want to cancel synchronization, click .
	Click to play back video file at slow speed. The slow speed includes 1/2, 1/4, 1/8, and 1/16. Click the icon once, the playback speed degrades one level.
	Click to switch to frame by frame backward playback. It is only valid in pause mode.
	Click to play backward. Now the icon becomes . Click to stop backward play.
	Click to start playback. Now the icon becomes . Click to pause playback video.

Signal Words	Description
	Click to switch to frame by frame playback.  It is only valid in pause mode.
	Click to play back at fast speed. The fast speed includes 1, 2, 4, 8, and 16. Click the icon once, the playback speed upgrades one level.
	Displays playback speed. Drag  to the left or right, it is to playback at fast forward or fast backward.
	Click to capture an image.
	Click this icon to tag the current video.
	Click to obtain one part of record, and save it in designated storage path.
	Click  to mute. The icon becomes  . Click  to unmute.
	Click to play back at full screen.
—	<p>Time bar. Displays record type and record file period.</p> <ul style="list-style-type: none"> There are two record file bars on the time bar. The top bar is to display record time of selected window. The bottom bar is to display record time of all selected remote devices. The time bar adopts color to categorize record type. Green=Regular record. Red=Alarm record. Blank=No record.  Time scale is to display record file date and time. System automatically adjusts time scale according to the record playback process. On the time bar, you can: <ul style="list-style-type: none"> Click the time bar and rotate the mouse wheel button to adjust the time accuracy. Press the time bar and then drag to the left or right. It is to move the time bar to view the hidden record time. Drag time scale to adjust start time of record playback. Click or drag the time scale to position where there is a record, system starts playing from the selected time. Click or drag the time scale to position where there is no record, system stops playing record.

Signal Words	Description														
<table border="1"> <tr> <td></td> <td>Digital ▶</td> </tr> <tr> <td>⏏</td> <td>Original ▶</td> </tr> <tr> <td>🔊</td> <td>Audio ▶</td> </tr> <tr> <td></td> <td>Zoom ▶</td> </tr> <tr> <td>⏏</td> <td>Original ▶</td> </tr> <tr> <td>🔊</td> <td>Audio ▶</td> </tr> <tr> <td>🌀</td> <td>Fisheye ▶</td> </tr> </table>		Digital ▶	⏏	Original ▶	🔊	Audio ▶		Zoom ▶	⏏	Original ▶	🔊	Audio ▶	🌀	Fisheye ▶	<p>Shortcut menu: Right-click on the playback window, you can view the shortcut menu.</p> <ul style="list-style-type: none"> Zoom: It is to zoom in a specified zone and view the details. Original scale: It is to set view window scale. <ul style="list-style-type: none"> ON: System automatically adjusts video window scale according to the video resolution. OFF: System automatically adjusts video window scale according to the remote device amount and the free space on the playback panel. Audio: Set audio output. Fisheye: Set the installation method and display mode of fisheye camera.
	Digital ▶														
⏏	Original ▶														
🔊	Audio ▶														
	Zoom ▶														
⏏	Original ▶														
🔊	Audio ▶														
🌀	Fisheye ▶														
🔍	Select faces or humans on the video to search for similar targets.														
✕	Point to the playback window, system pops up task column. Click the icon to close the playback window.														

7.2.2 Clipping Recorded Video

Clip one part of the recorded video, and save it in designated storage path.



Connect USB device to the system if you are on the local menu to operate.

Step 1 On the **LIVE** page, click **+** and then select **SEARCH**.

Step 2 Play video file.

Figure 7-33 Playback

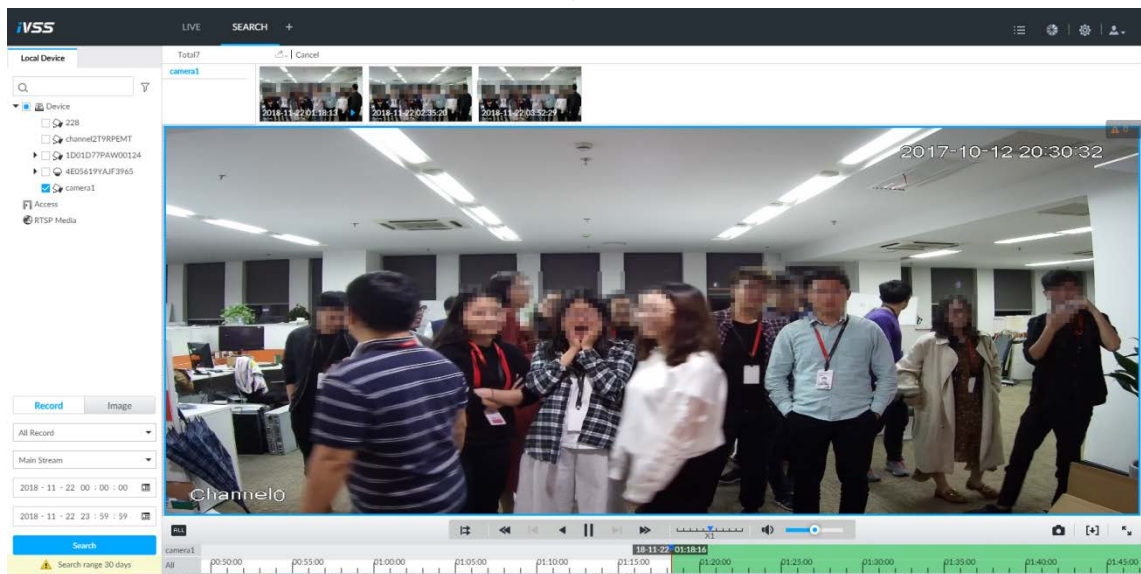

Step 3 Click **[+]**.

Figure 7-34 Video clipping frame



Step 4 Click the record edit column (the blue column) and drag to the left or right, to select start time and end time of clipping.

Step 5 Click **Save Immediately**.

Figure 7-35 Save

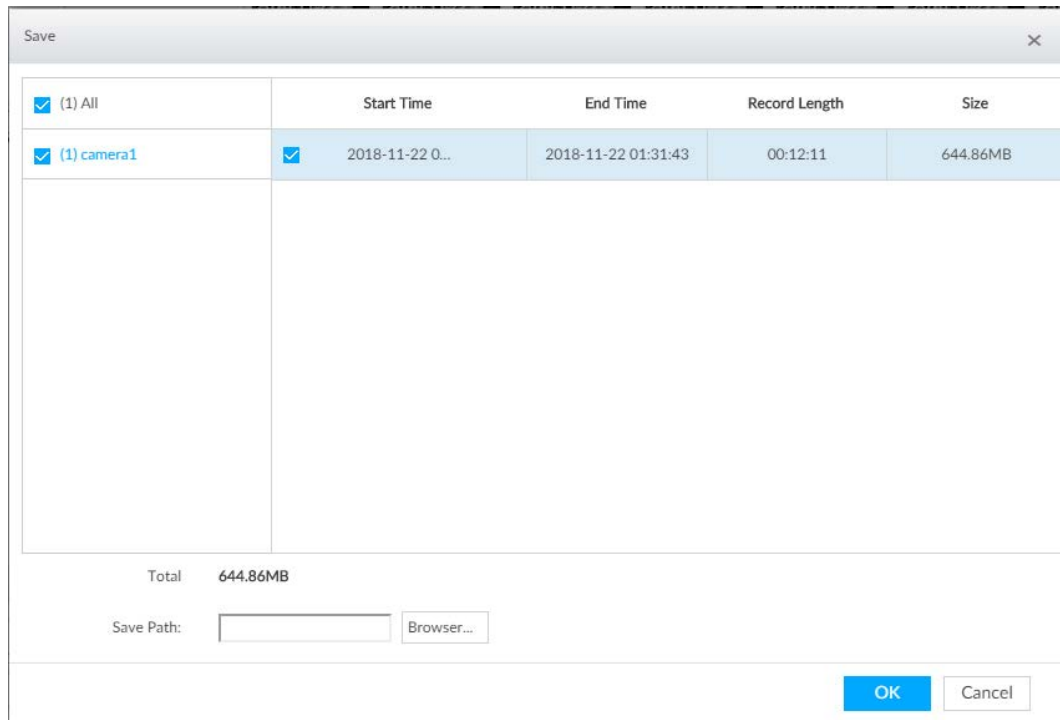

Step 6 Click **Browser** to select saving path.

Step 7 Click **OK**.

7.2.3 Playing Back Snapshots

Search and play back image according to remote device, image type, and snapshot time.

Step 1 On the **LIVE** page, click **+** and then select **SEARCH**.

Step 2 Select a remote device, and then click **Image**.



System supports maximum 1 remote device.

Figure 7-36 Image playback (1)

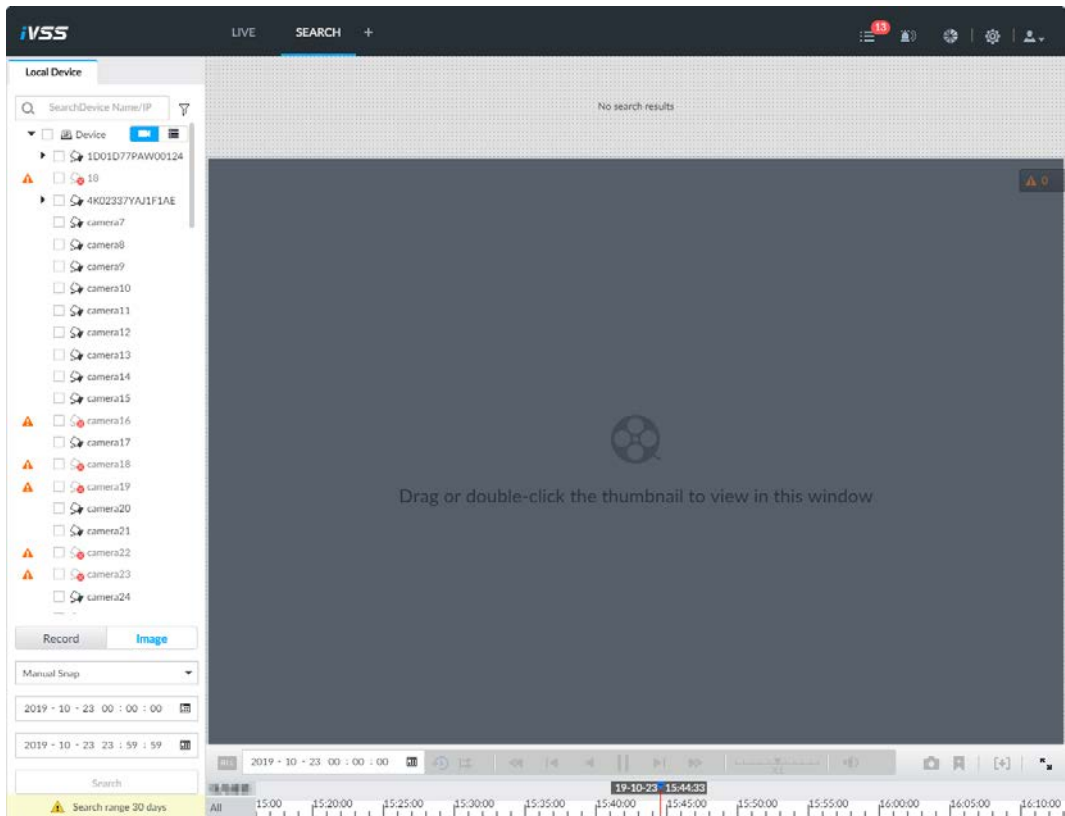

Step 3 Select image type, including **Manual Snap**, **Video Detect**, **IO Alarm** and **Thermal**.

Step 4 Set search time.

- Method 1: Click the date or time on the time column, change time or date value.
- Method 2: Click the date or time on the time column, use the mouse wheel to adjust time or date value.
- Method 3: Click , set date or time on the schedule, click **OK**.

Figure 7-37 Schedule



Step 5 Click **Search**.

Figure 7-38 Image thumbnail

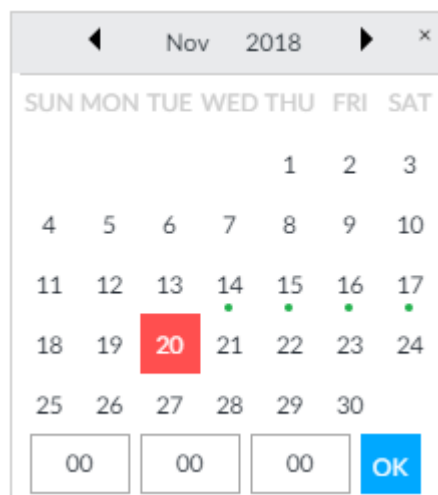
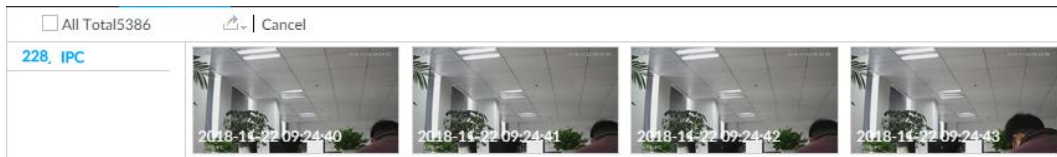

- The selected remote device is on the left panel. Click a remote device, and the image thumbnail is on the right panel.
- Click or to move thumbnail list, and display the hidden thumbnail.
- Point to the thumbnail, you can view remote device name, and snapshot time of the corresponding thumbnail.
- Point to the thumbnail list. The system displays . Click the icon to hide the thumbnail list. If the thumbnail list is hidden, click to display the thumbnail list.

Step 6 Drag the thumbnail to the playback window or double-click the thumbnail. Device begins playing the image.

Figure 7-39 Image playback (2)

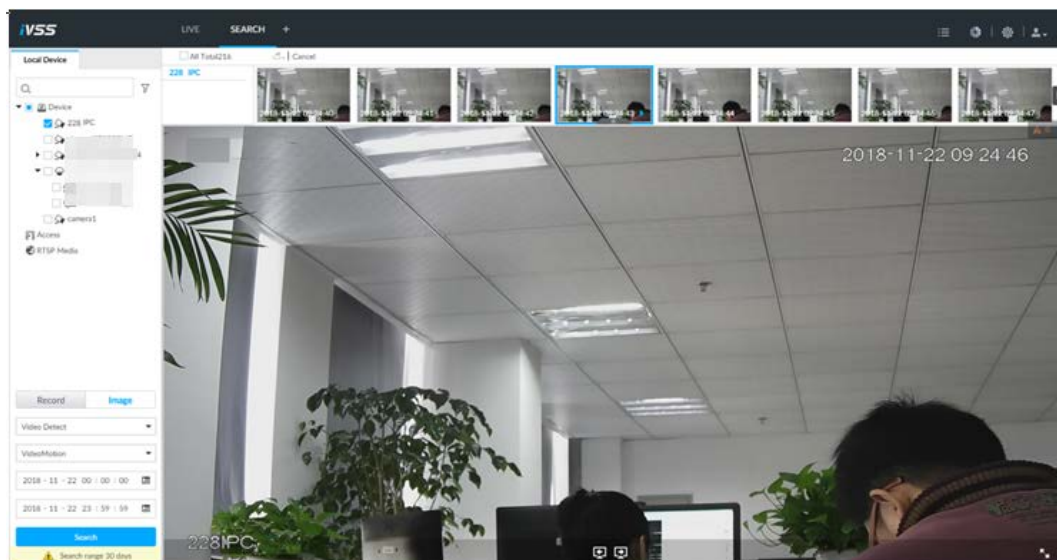

Point to the playback window, you can see the following icons.

Table 7-12 Icons

Icon	Description
	Click to switch to the previous image or the next image.
	<ul style="list-style-type: none"> • To play one image, click to go to the previous image or the next image. • To play several images at the same time, click to go to the previous group or the next group.
	Click to display at full screen. Click again to cancel full screen.

7.2.4 Exporting File

Export record file or image to the designated storage path.



- The default record file mode is .dav and the image file mode is .jpg.
- Connect USB device to the system if you are on the local menu to operate.

Step 1 On the **LIVE** page, click **+** and then select **SEARCH**.

Figure 7-40 Search (1)

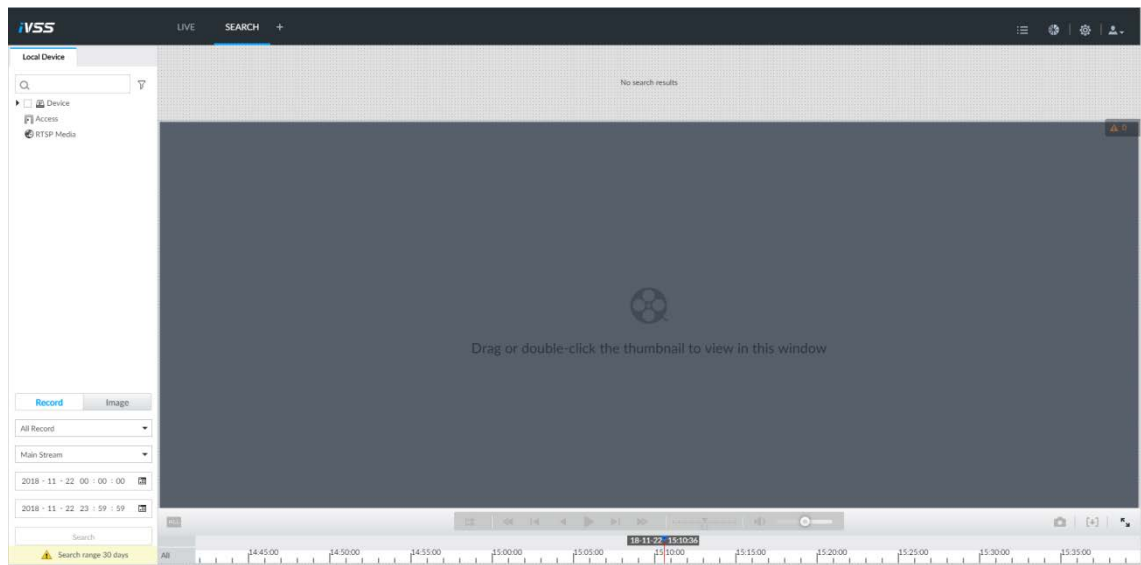

Step 2 Search record file or image.

- 1) Click **Record** or **Image** tab.
- 2) Select a remote device and then set search criteria.
- 3) Click **Query**.

Figure 7-41 Thumbnail

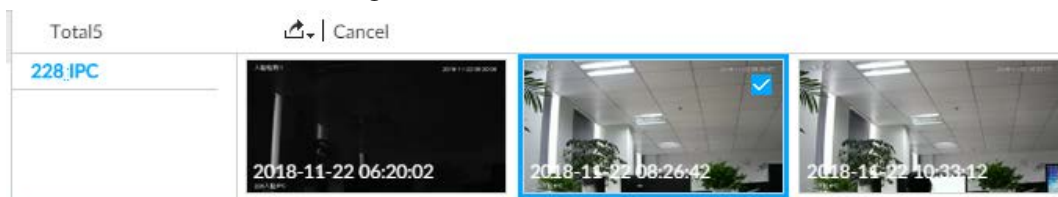

Step 3 Select the record file or image you want to export.

- Point to the thumbnail and then click to select the thumbnail. means checked.
- Click **Cancel**, it is to cancel all record files or images.

Step 4 Select file storage path.

- 1) Click  and then select **Export record** or **Export image**.



The following steps are to export video file. See the actual page for detailed information.

- 2) Click **OK**.

Figure 7-42 Save

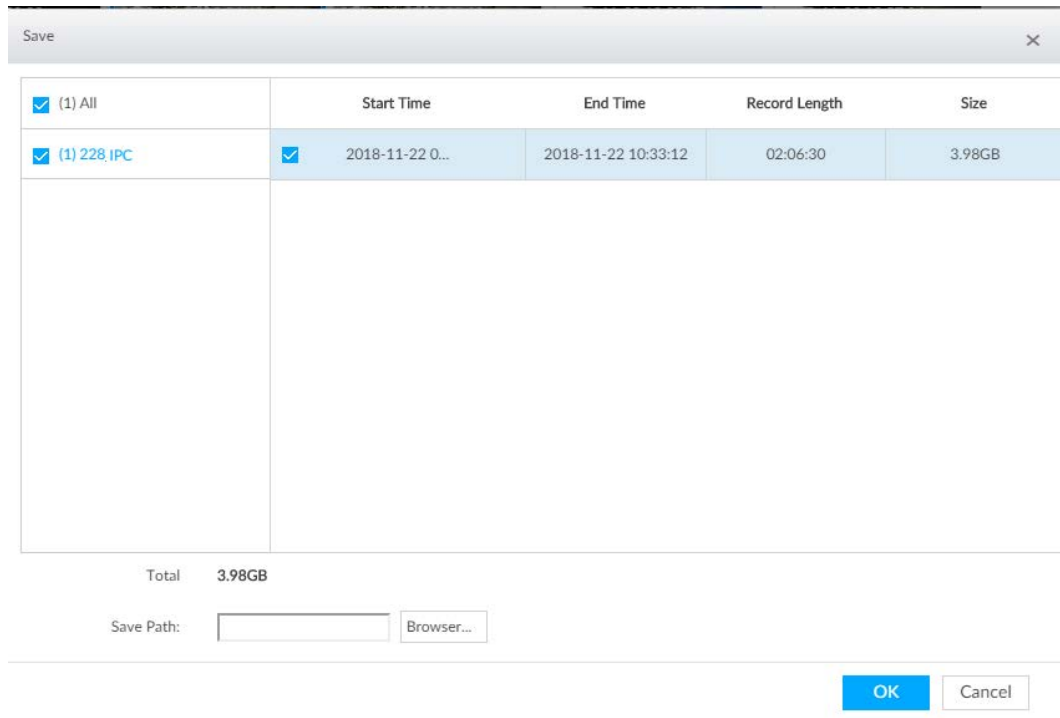

<input checked="" type="checkbox"/> (1) All	Start Time	End Time	Record Length	Size
<input checked="" type="checkbox"/> (1) 228 IPC	<input checked="" type="checkbox"/> 2018-11-22 0...	2018-11-22 10:33:12	02:06:30	3.98GB

Total 3.98GB

Save Path:

- 3) Click **Browser** to select saving path.



For local operation, after you set storage path, the **Save** page displays the **Format** button. Click the **Format** button to clear all data on the USB storage device. The formatting operation will clear all data. Be cautious.

- 4) Click **OK**.
Device goes back to **Save** page.

Step 5 Click **OK**.
The system starts to export files.

Figure 7-43 Download

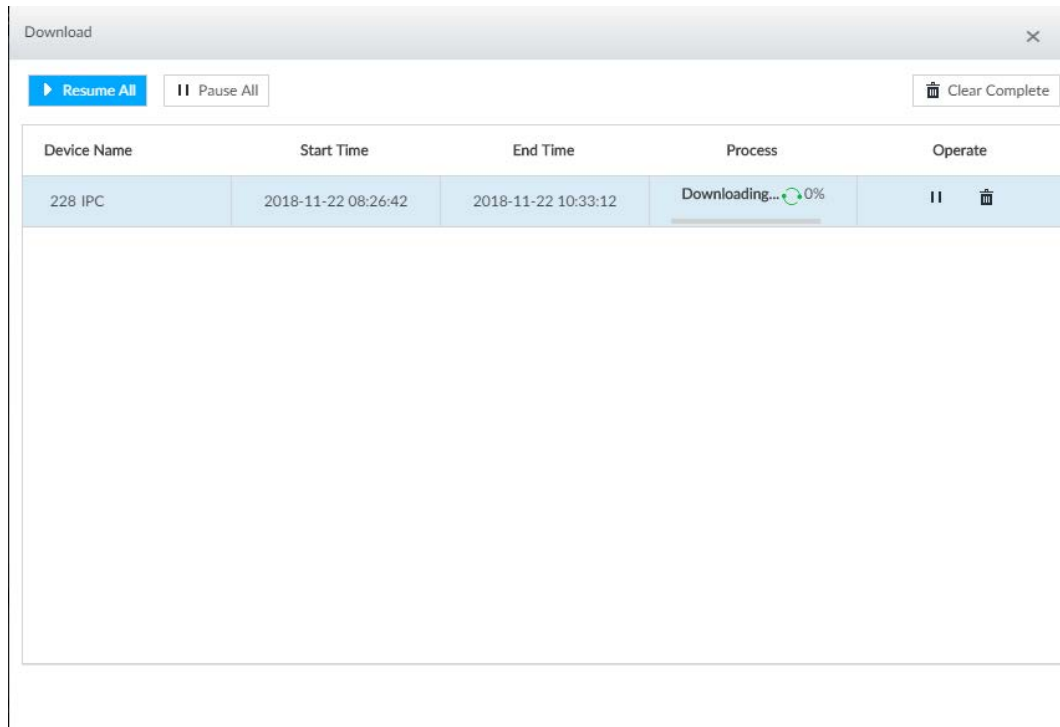

- Click **Pause all** to pause all download tasks. Click **Start all** to resume download tasks.
- Click **Clear completed columns** to delete all downloaded tasks.
- Click of the corresponding task to pause download task. Click to resume download.
- Click of the corresponding task to delete download task.

7.2.5 Video Tag

Tag specific video segments or pictures for the ease of search.

Step 1 On the **LIVE** page, click , and then select **SEARCH**.

Step 2 Search for pictures or videos.

- 1) Click the **Record** or **Image** tab.
- 2) Select a camera, and then set search conditions.
- 3) Click **Search**.

Step 3 Click at the lower-right corner of the playback window.

Figure 7-44 Tag

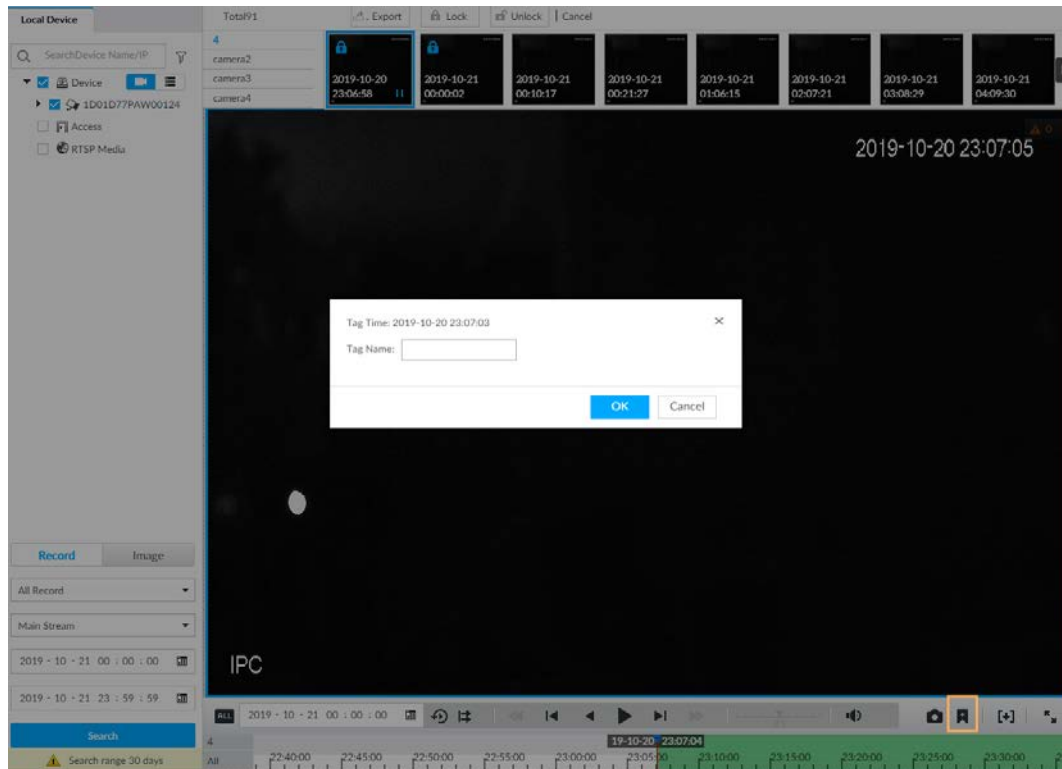

Step 4 Enter tag name, and then click **OK**.

7.2.6 Locking Files

Lock specific videos or pictures so they cannot be viewed. An locked file can only be viewed after being unlocked.

Step 1 On the **LIVE** page, click **+**, and then select **SEARCH**.

Step 2 Search for pictures or videos.

- 1) Click the **Record** or **Image** tab.
- 2) Select a camera, and then set search conditions.
- 3) Click **Search**.

Step 3 Select the video files to be locked.

- Point to the thumbnail, and then click to select the video.
- You can click **Cancel** to cancel the selected videos.

Step 4 Click **Lock**.

Step 5 (Optional) Click **Unlock** to unlock the locked videos.

7.3 File Management

7.3.1 Face Management

See "6.3.3.4 Configuring Device Face Database".

7.3.2 Vehicle Management

See "6.8.3 Configuring Vehicle Database".

7.3.3 Tag Management

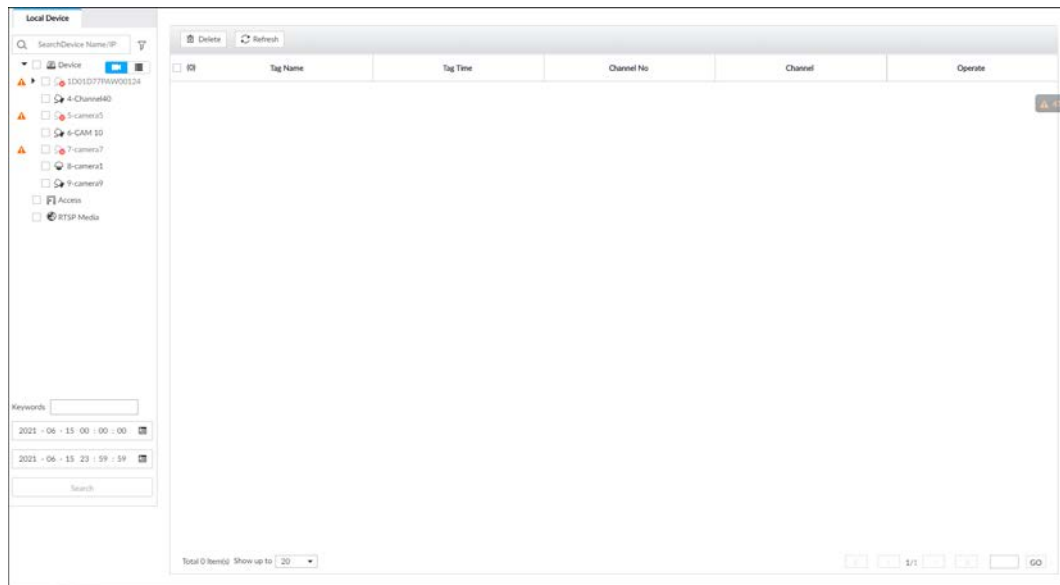

Step 1 On the **LIVE** page, click **+**, and then select **FILE > Tag Management > Tag Management**.

Figure 7-45 Tag management



Step 2 Select a channel, set start time and end time, and then click **Search**.

The tags during the set time period are displayed.

- Click  to view the corresponding video.
- Click  to edit the tag.
- Click  to delete the tag.
- Select multiple tags and click **Delete** to delete the tags in batches.
- Click **Refresh** to video the latest tags.

7.3.4 File Lock

View the locked video files, and you can unlock them.

Step 1 On the **LIVE** page, click **+**, and then select **FILE > File Lock > File Lock**.

Figure 7-46 File lock

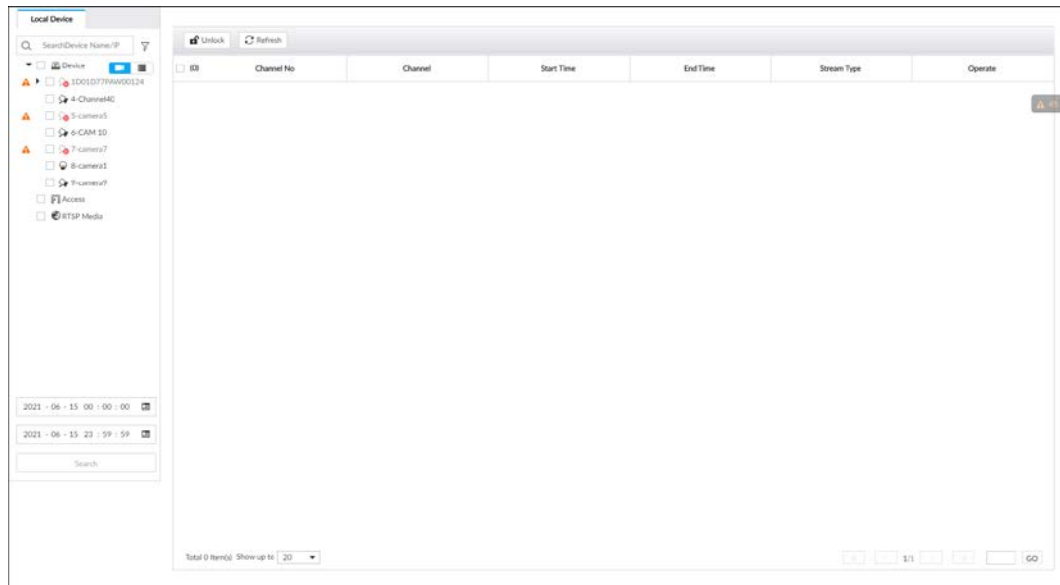

- Step 2** Select a channel, set start time and end time, and then click **Search**.
The locked files are displayed.
- Click to view the video of the locked file.
 - Click **Refresh** to view the latest locked files.
 - Click to unlock a file.
 - Select multiple files and click **Unlock** to unlock the files in batches.

7.3.5 Voice Management

Upload and manage audio files, so the device plays audios in case of events.



- You can upload .pcm, .mp3, .wav, and .aac files.
- A single audio file shall not be less than 2 KB and shall not exceed 10 MB.
- Total size of imported audio files shall not exceed 200 MB.

Step 1 On the **LIVE** page, click , and then select **FILE > Voice Manage > Voice Manage**.

Figure 7-47 Audio management

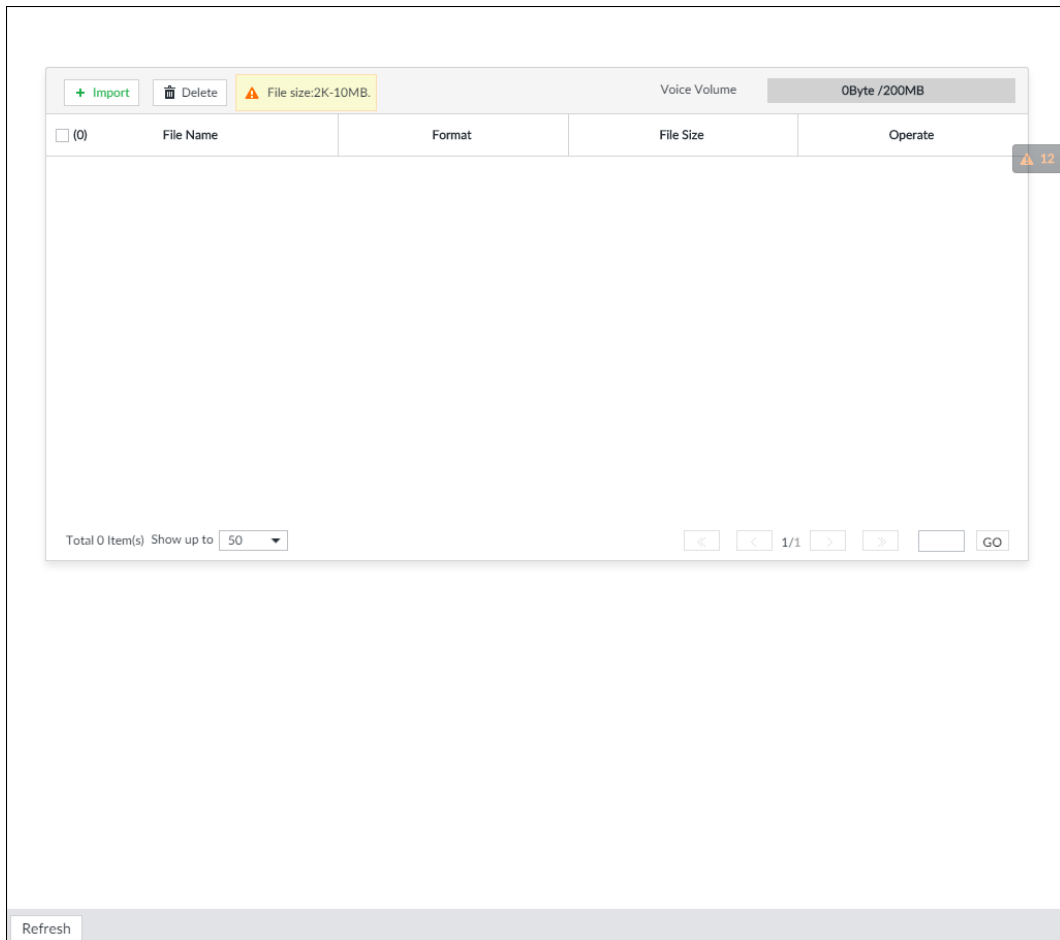

Step 2 Click **Import** to select the audio files that you want to import.

Step 3 Click **OK**.

The uploaded audio file is displayed.

After the audio file is uploaded, it can be renamed or deleted.

Table 7-13 Audio file operation

Name	Operation
Rename audio file	Click to rename the audio file.
Delete audio file	<ul style="list-style-type: none"> Delete: Click beside the audio file. Batch delete: Select multiple audio files, and click Delete.

7.3.6 Watermark Verification

Verify whether a video file is tempered.

Step 1 On the **LIVE** page, click , and then select **FILE > Watermark > Watermark**.

Figure 7-48 Watermark

Video File: Browse Verify

Watermark Info:

Tampered Watermark Info

Sn	Error Type	Watermark Time

12

Step 2 Click **Browse** to select a video file.

Step 3 Click **Verify**.

- Normal: If the verification result is normal, the correct watermark is displayed.
- Exception: If the verification result is abnormal, the abnormal watermark and its type are displayed.

7.4 Task Management

7.4.1 AI Analysis Task

Configure AI analysis tasks for metadata of recorded videos. After the intelligent analysis task is completed, you can view the metadata video on the playback page.

7.4.1.1 Configuration Procedure

Figure 7-49 Analyze files imported from USB storage device



Figure 7-50 Analyze local files



7.4.1.2 Importing Task Resources

Import task resources from PC or USB storage device for AI analysis.

Procedure

Step 1 On the **LIVE** page, click **+**, and then select **TASK > Resource Management**.

Figure 7-51 Resource management

ID	File Name	Start Time	End Time	File Size	Process
1	4549ghghghh[0].dav	2021-03-11 10:37:33	2021-03-11 11:17:33	492.89 MB	Completed 100%
2	jdongche [redacted].dav	2021-06-02 11:41:42	2021-06-02 11:46:28	139.50 MB	Completed 100%
3	jdongche [redacted].dav	2021-06-02 11:41:42	2021-06-02 11:46:28	139.59 MB	Completed 100%
4	IPC_20210601112419_2021060111291110[0].dav	2021-06-01 11:24:19	2021-06-01 11:25:30	52.85 MB	Completed 100%
5	IPC_20210601140351_20210601143148[0].dav	2021-06-01 14:03:51	2021-06-01 14:31:47	1.65 GB	Completed 100%
6	fufufu[0].dav	2021-06-01 11:24:18	2021-06-01 11:25:10	7.87 MB	Completed 100%
7	fufufu[0].dav	2021-06-01 11:24:18	2021-06-01 11:25:10	7.87 MB	Completed 100%
8	rhghgh1031103733_20210311117350[0].dav	2021-03-11 10:37:33	2021-03-11 11:17:33	492.89 MB	Completed 100%
9	fufufu [redacted].dav	2021-06-01 11:24:18	2021-06-01 11:25:10	7.87 MB	Completed 100%
10	fufufu [redacted].dav	2021-06-01 11:24:18	2021-06-01 11:25:10	7.87 MB	Completed 100%

Step 2 Click **Import** to import .dav file from PC or USB storage device.

Related Operations

- Delete** : Delete task resources.
- File Name** : Search for task resources by file name.

7.4.1.3 Creating AI Analysis Task

Step 1 On the **LIVE** page, click **+**, and then select **TASK > AI Analysis Task**.

Step 2 Click **Create**.

Step 3 Select the files or channels to be analyzed.

- In the **Video File** tab, select the video files to be analyzed. The files are imported from PC or USB storage device.
- In the **Local File** tab, select the channels whose videos you want to analyze.



In the device tree, indicates that the camera has been configured with intelligent analysis task.

Figure 7-52 Create AI analysis task

ID	No.	Task Name	Analysis Target	Start Time	End Time
1	1	4549ghghghh[0].dav	Human/Vehicle/Non Motor Vehicle/Face	2021-03-11 10:37:33	2021-03-11 11:17:33
2	2	jdongche [redacted].dav	Human/Vehicle/Non Motor Vehicle/Face	2021-06-02 11:41:42	2021-06-02 11:46:28
3	3	jdongche [redacted].dav	Human/Vehicle/Non Motor Vehicle/Face	2021-06-02 11:41:42	2021-06-02 11:46:28
4	4	IPC_20210601112419_2021060111291110[0].dav	Human/Vehicle/Non Motor Vehicle/Face	2021-06-01 11:24:19	2021-06-01 11:25:30
5	5	IPC_20210601140351_20210601143148[0].dav	Human/Vehicle/Non Motor Vehicle/Face	2021-06-01 14:03:51	2021-06-01 14:31:47
6	6	fufufu[0].dav	Human/Vehicle/Non Motor Vehicle/Face	2021-06-01 11:24:18	2021-06-01 11:25:10
7	7	fufufu[0].dav	Human/Vehicle/Non Motor Vehicle/Face	2021-06-01 11:24:18	2021-06-01 11:25:10
8	8	rhghgh1031103733_20210311117350[0].dav	Human/Vehicle/Non Motor Vehicle/Face	2021-03-11 10:37:33	2021-03-11 11:17:33
9	9	fufufu [redacted].dav	Human/Vehicle/Non Motor Vehicle/Face	2021-06-01 11:24:18	2021-06-01 11:25:10
10	10	fufufu [redacted].dav	Human/Vehicle/Non Motor Vehicle/Face	2021-06-01 11:24:18	2021-06-01 11:25:10
11	11	fufufu [redacted].dav	Human/Vehicle/Non Motor Vehicle/Face	2021-06-01 11:24:18	2021-06-01 11:25:10
12	12	fufufu [redacted].dav	Human/Vehicle/Non Motor Vehicle/Face	2021-06-01 11:24:18	2021-06-01 11:25:10
13	13	fufufu [redacted].dav	Human/Vehicle/Non Motor Vehicle/Face	2021-06-01 11:24:18	2021-06-01 11:25:10
14	14	fufufu [redacted].dav	Human/Vehicle/Non Motor Vehicle/Face	2021-06-01 11:24:18	2021-06-01 11:25:10
15	15	fufufu [redacted].dav	Human/Vehicle/Non Motor Vehicle/Face	2021-06-01 11:24:18	2021-06-01 11:25:10
16	16	fufufu [redacted].dav	Human/Vehicle/Non Motor Vehicle/Face	2021-06-01 11:24:18	2021-06-01 11:25:10

Step 4 Select a task type from **Analysis Target**.

- 1) Click the analysis target cell.

Figure 7-53 Analysis target

RuleName	Enabled
People	Enabled <input checked="" type="checkbox"/> Face <input checked="" type="checkbox"/>
Vehicle	<input checked="" type="checkbox"/>
Non-MotorVehicle	Enabled <input checked="" type="checkbox"/> Face <input checked="" type="checkbox"/>

OK Cancel

- 2) Select a task type.

Table 7-14 Task type description

Rule Name	Operations
People	<ul style="list-style-type: none"> • Click <input type="checkbox"/> next to Enabled to enable human detection as well as face detection. • Click <input checked="" type="checkbox"/> next to Face to disable face detection. <p>You can only enable face detection after human detection has been enabled.</p>
Vehicle	Click <input type="checkbox"/> to enable vehicle detection.
Non-Motor Vehicle	<ul style="list-style-type: none"> • Click <input type="checkbox"/> next to Enabled to enable non-motor vehicle detection as well as face detection. • Click <input checked="" type="checkbox"/> next to Face to disable face detection. <p>You can only enable face detection after non-motor vehicle detection has been enabled.</p>

- 3) Click **OK**.



Select multiple channels or video files, click **Unified Configuration**, and then you can configure tasks in batches.

Step 5 Select start time and end time.

Step 6 Click **Finish** to go back to the **AI Analysis Task** page.

Click **apply** to create more tasks on the current page.

Figure 7-54 AI analysis task

Execution Order	Task Name	Task Type	Device Name	Channel No.	State	Process	Remaining Time	Executed Time	Analysis Target	Creation Time	Operate
1	22_20210727145749_2...	Video File	--	--	Completed	100%	Dec.	2min 0sec.	Human	2021-09-07 10:13:03	[Start] [Pause] [Delete] [Download] [Play] [Priority Up] [Priority Down]
2	1	Local File	1	30	Completed	100%	Dec.	1hr 33min 48sec.	Human	2021-09-07 21:05:39	[Start] [Pause] [Delete] [Download] [Play] [Priority Up] [Priority Down]
3		Local File		40	Completed	100%	Dec.	1hr 15min 14sec.	Human	2021-09-07 21:06:42	[Start] [Pause] [Delete] [Download] [Play] [Priority Up] [Priority Down]
4	17	Local File	17	1	Completed	100%	Dec.	1min 16sec.	Human	2021-09-08 14:35:29	[Start] [Pause] [Delete] [Download] [Play] [Priority Up] [Priority Down]
5	113	Local File	113	5	Completed	100%	Dec.	1hr 23min 34sec.	Human	2021-09-08 14:24:24	[Start] [Pause] [Delete] [Download] [Play] [Priority Up] [Priority Down]



After an AI analysis task is created, the Device automatically runs analysis within the defined execution period. During the period, real-time AI analysis is suspended.

On the **AI Analysis Task** page, you can perform the following operations.

Table 7-15 Task operations

Function	Operation
	Click to start a task.
	Click to delete a task.
	Click to download the task video.
	Click to play back video of the task.
	Click to increase the priority of the task.
	Click to lower the priority of the task.
Start	Select tasks, and then click Start to start the tasks in batches.
Pause	Select tasks, and then click Pause to pause the tasks in batches.
Delete	Select tasks, and then click Delete to delete the tasks in batches.
Execution Period	Select one or more tasks, click Execution Period , and then select a time period. Tasks automatically run during this time period.

7.4.1.4 Viewing Analysis Results

On the **LIVE** page, click , and then select **AI SEARCH**. On the **AI Search** page, you can view analysis results.

- If the analysis target is **Human**, see "6.5.4.1 Human Search".
- If the analysis target is **Vehicle**, see "6.5.4.2 Vehicle Search".
- If the analysis target is **Non-motor Vehicle**, see "6.5.4.3 Non-motor Vehicle Search".
- If the analysis target is **Face**, see "6.3.2.6 Face Search".

7.4.2 Extracting Eigenvector Again

Re-extract Eigenvector of images with unmatched versions, to improve AI analysis accuracy.



The Extract Eigenvector Again function is triggered automatically after Eigenvector model is updated. After the model version update, the system re-extracts face databases and passerby databases first and then hot data. The hot data includes history capture data.

Step 1 Log in to PCAPP.

Step 2 On the **LIVE** page, click , and then select **TASK > Extract Eigenvector Again**.

Step 3 Click to enable the function.

Figure 7-55 Extract Eigenvector Again



Step 4 Specify the start time and end time of the day.

- The system automatically creates tasks to re-extract Eigenvector of history images with unmatched model versions during the period.
- During the re-extraction period, the AI functions are not available.

7.5 Backup

Step 1 On the **LIVE** page, click and then select **BACKUP**.

Figure 7-56 Backup

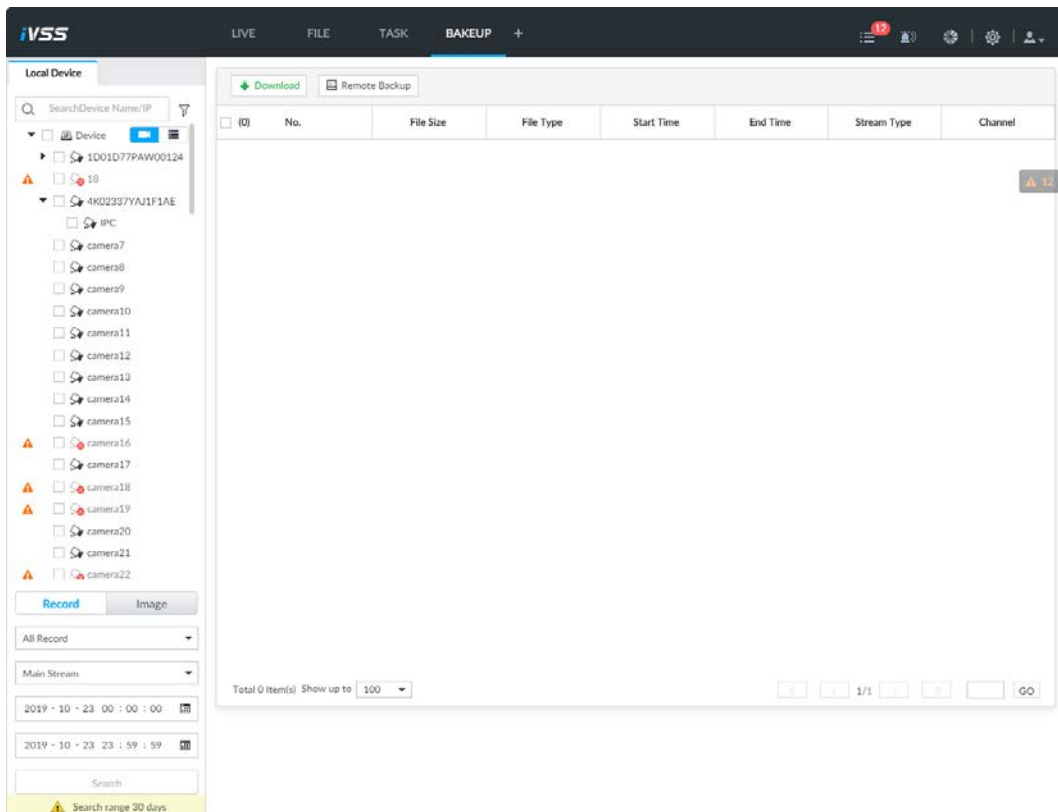

Step 2 Select a channel from the resource tree on the left.

Step 3 Select a file type.

- Record
 - 1) Select a record type from **All Record**, **Instant Record**, **Video Detect** and **IO Alarm**.
 - 2) Select a stream type from **Main Stream** and **Sub Stream**.
 - 3) Set the time period.
- Image
 - 1) Select an image type from **Manual Snap**, **Video Detect**, and **IO Alarm**.
 - 2) Select a stream type from **Main Stream** and **Sub Stream**.

3) Set the time period.

Step 4 Click **Search**.

Step 5 Back up files by downloading or remote backup.

- Download

1) In the search results, select one or more files, and then click **Download**.

Figure 7-57 Save

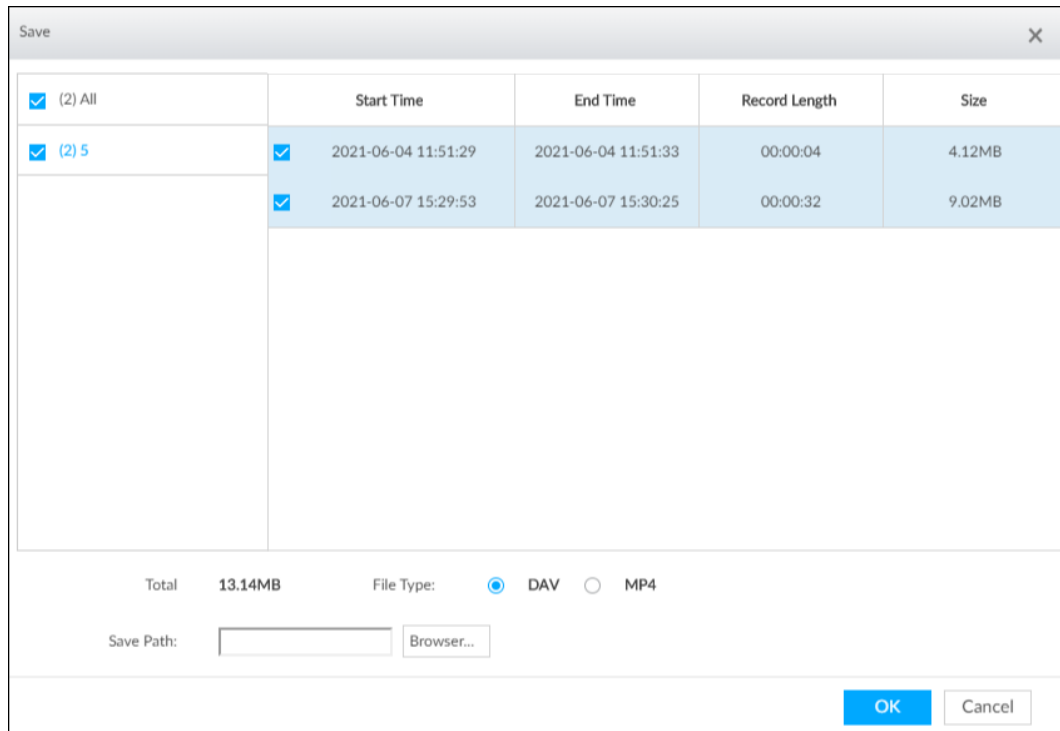

2) Select a file type.

3) Click **Browse** to set saving path. You can download files to PC or USB storage device.



When downloading to USB storage device, making sure that the USB device has already been connected to the Device.

4) Click **OK**.

- Remote backup

1) In the search results, select one or more files, and then click **Remote Backup**.

Figure 7-58 Remote device

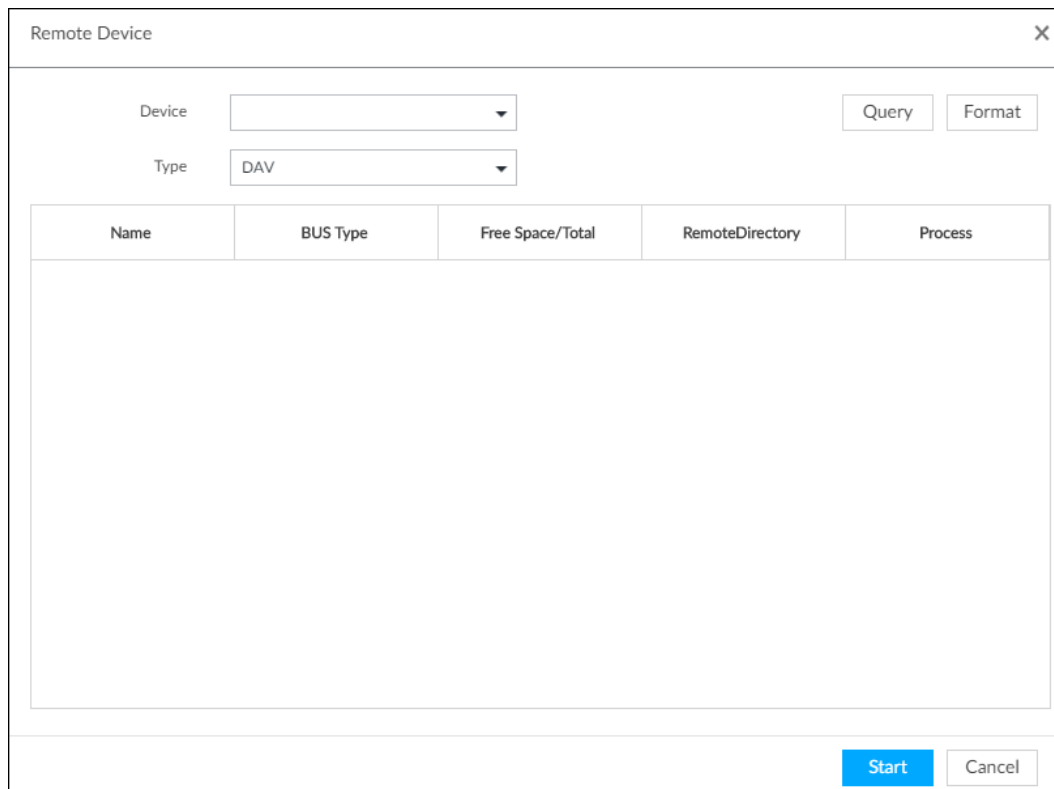

- 2) Click **Query** to search for connected third-party storage devices.
- 3) Select a storage device, and then in the **Type** box, select a target format for the file.
- 4) Click **Format** to format the selected storage device. The formatting operation will clear all data of the storage device. Be cautious.
- 5) Click **Start**.



Make sure that external HDD or disk array enclosure has been connected to the eSATA port of the Device.

7.6 Alarm List

Click to display alarm list. You can view alarm device name, alarm time and alarm type.

Figure 7-59 Alarm list



- Number 9 is the number of alarm event to be processed. The value changes according to alarm amount. It displays maximum 200 unprocessed alarm events.
- Click to lock alarm list. The alarm list is open and cannot hide. Click the icon again to cancel lock function. Point to other position, and the alarm list displays for a period of time and then automatically hides.





- Click  to confirm alarm event. The confirmed event will be removed from the alarm list.
- Click the alarm event on the alarm list. The device displays the 20 seconds video before and after the alarm event occurred.
 - ◊ Click  to pause play. Now the icon becomes . Click  again to continue to play.
 - ◊ Click **OK and close**, confirm the alarm event and then exit the page.

Figure 7-60 Alarm video



7.7 Display Management

Enable connected display or lock the screen.

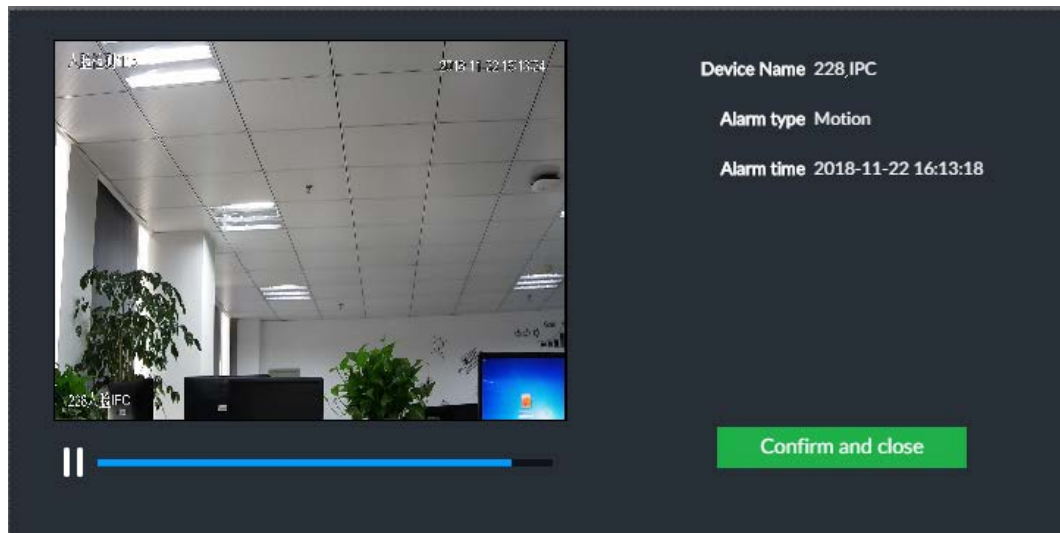
7.7.1 Multiple-screen Control

Device can connect to multiple displays at the same time. You can select a display you want to use.



- The multiple-screen control function is for local menu only.
- Enter **Display Output** page, you can enable a display or set its resolution. See "8.8.3 Display" for detailed information.
- The page might vary since the connected display amount is not the same.

Click .





- SN 1–3 represent displays connected to HDMI 1–HDMI 3. The main screen refers to the device connected to VGA and HDMI 1 port. The displays connected to the HDMI 2 and HDMI 3 are the sub screens. The output interfaces of main screen and the sub screen are not the same and the supported functions are different.
- VGA and HDMI 1 are outputting the same video source. Three HDMI ports can output different video sources.
-  means connected and enabled display.  means connected but not enabled display.
- Click  or  to disable or enable display. Device adopts main screen by default and the main screen cannot be disabled.

Figure 7-61 Display

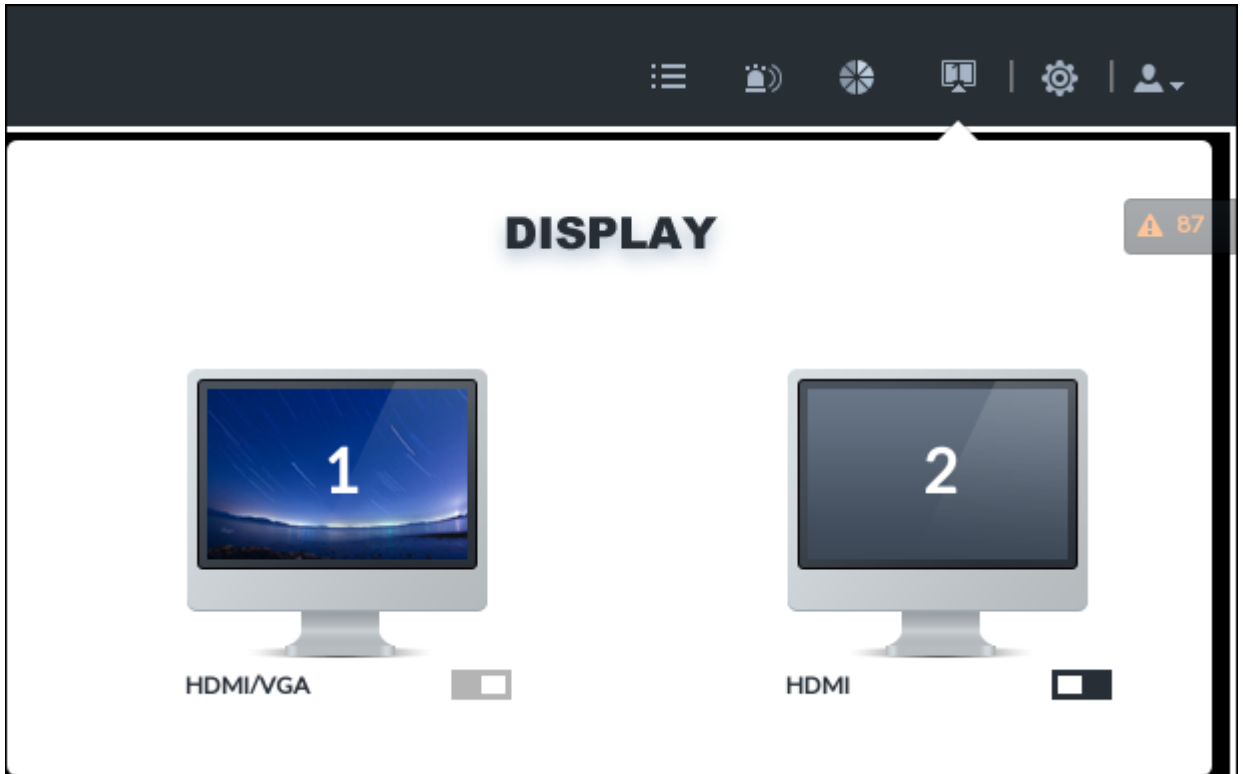

Table 7-16 Difference between main screen and sub screen

Name		Main screen	Sub screen
Function Operations	User operation (Login, log out, change password, lock)	Yes	Yes
	Preview and Monitor	Yes	Yes
	Search	Yes	Yes
	Confirm alarm	Yes	No
	File Management	Yes	Yes
	Intelligent Analytics	Yes	Yes
	Multiple-screen control	Yes	No
	System Info	Yes	Yes
	Background Task	Yes	Yes
	Operation and Maintenance Management	Yes	Yes
	Device Operation (Reboot, shut down)	Yes	No

Name		Main screen	Sub screen
System Configuration	Device, network, event, storage, account, security strategy, and system management, and cluster.	Yes	No

7.7.2 Locking Screen

Click and then select **Lock** to lock the screen. The screen stops at current page and cannot operate other functions.

If you want to unlock the screen, click any position on the screen, enter password or user other account to login.

Figure 7-62 Unlock screen

7.8 System Info

View system information including system error, system alarm and system notification.

Click to display background task list.

Figure 7-63 System info

- Click **All**, **Error**, **Warning**, or **Notification** tab to view the corresponding system information list.
- Click to clear the corresponding system information.
- Click **Clear** to clear system information under current tab.

For example, click **All** tab and then click **Clear** button to clear all system information. Click **Error** tab and then click **Clear** button to clear all system error information.

7.9 Background Task

View background task running status.

Click  device displays background task list. Click **All**, **Running**, or **Waiting** to view the corresponding background task list.

Figure 7-64 Background task



7.10 Buzzer

View buzzer alarm messages.

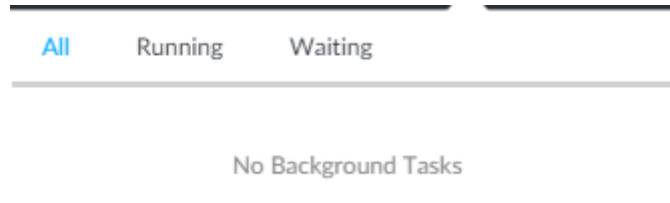
Click . The alarm messages are displayed.

Figure 7-65 Buzzer



8 System Configuration

This chapter introduces system configuration functions such as managing remote device, setting network, setting alarm event, setting HDD storage, managing user information, setting device security strategy, and setting system parameters.

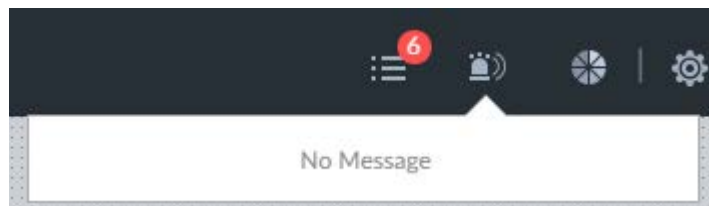
8.1 Configuration Window



Click  to open the configuration window.



Figure 8-1 Configuration window

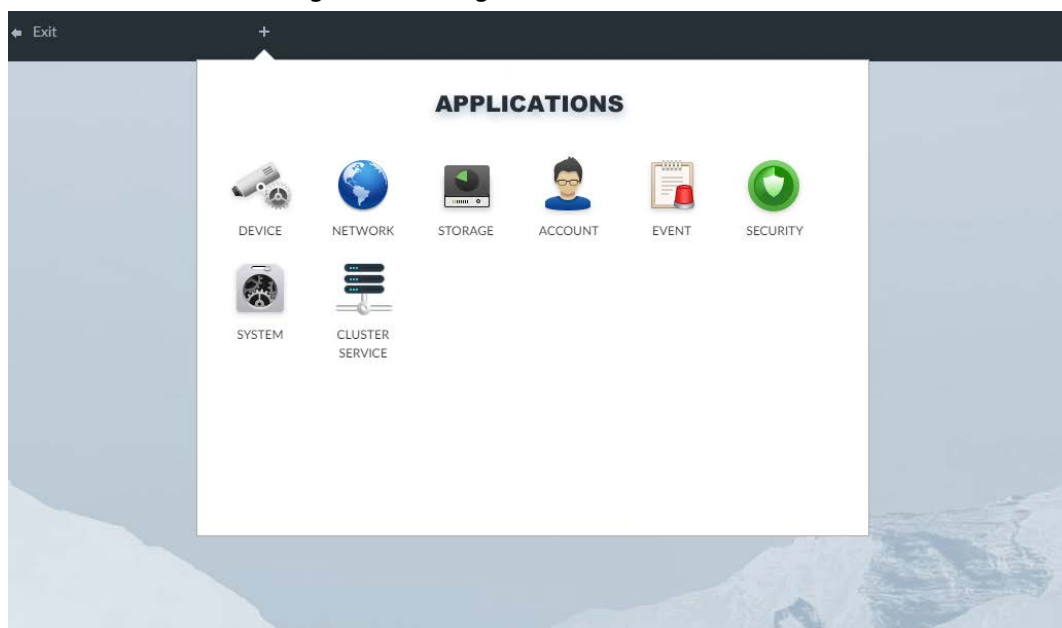

On this window, you can:

- Click the corresponding app icon to go to the corresponding page. The task column displays current running app name. Point to the app name and then click  to close the app.
- Click **Exit** to exit the page.

8.2 Device Management

Click  or click  on the configuration page, and then select **DEVICE**. The **DEVICE** page is displayed. You can set the Device or remote devices.

- Select the root node  in the resource tree to set IVSS name and storage plan.
- Select a remote device in the device list. Set its property, connection, video, OSD, and storage plan.

Figure 8-2 Device management



Click **+** or click **Add** to add remote device to the system.

8.2.1 Viewing Device Information

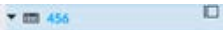
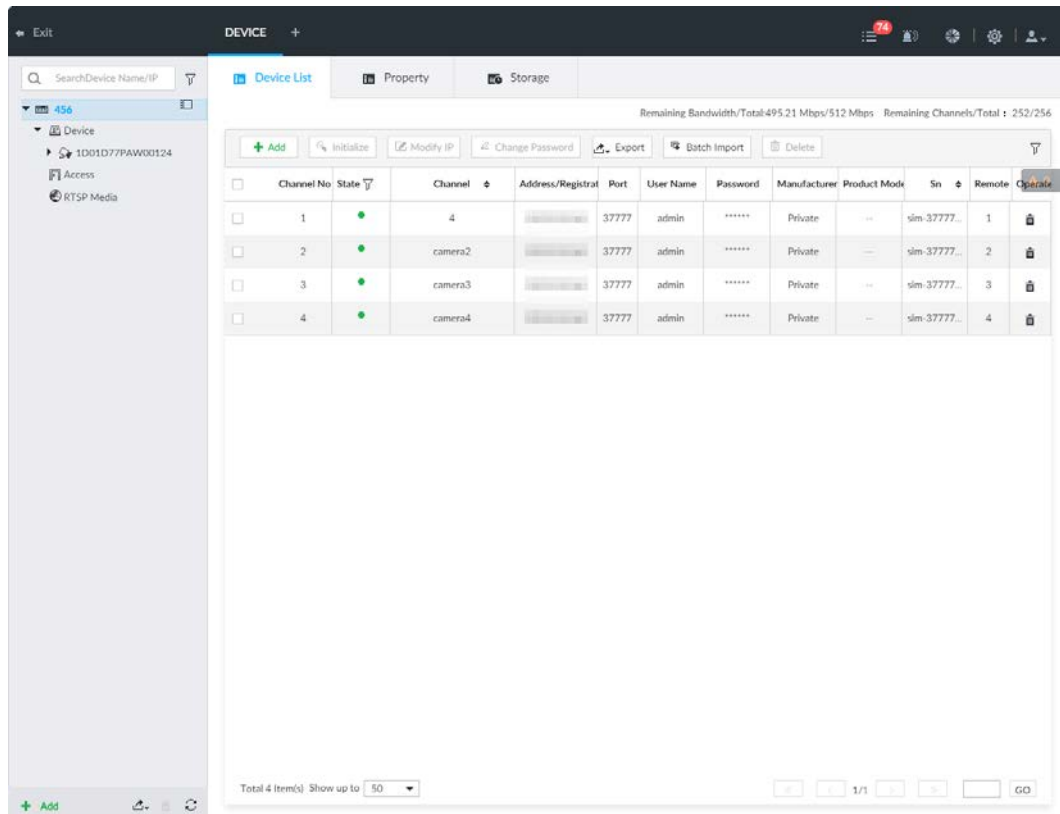
View information of the Device.

Step 1 Click and then select **DEVICE**.

Step 2 Select the root node in the resource tree, and then click the **Device Info** tab.

Step 3 Set parameters.

Figure 8-3 Device information

Device List
Device Info
Algorithm Version

Name

Description

∨ DEVICE INFO

Type	XXXXXXXXXX
SN	XXXXXXXXXX
MAC1	XXXXXXXXXX
MAC2	XXXXXXXXXX
MAC3	XXXXXXXXXX
MAC4	XXXXXXXXXX
Video In/Out	7/128
Input bandwidth	32.35Mbps/400.00Mbps
Video Out	3
Audio In/Out	1/2
Alarm In/Out	16/8
System Version	XXXXXXXXXX Build Date:2021-09-22 13:08:04
Security Baseline Version	V2.2
WEB Version	V4.0.0.144294.I
ONVIF Client Version	V2.4.1
ONVIF Server Version	20.12(V3.1.0.1087920)

Table 8-1 Device info

Parameters	Description
Name	Set device name.
Description	Device description.
Device info	Displays device info, including type, SN, MAC, number of video, audio and alarm in/out channels, video input bandwidth, system version, security baseline version, web version, and algorithm version.

Step 4 Click **Save**.

8.2.2 Remote Device

The Device supports to add remote device, modify its IP address and configurations, and export its information.

8.2.2.1 Viewing Remote Devices

View connected remote devices. For details about adding devices, see "8.2.2.3 Configuring Remote Devices".

Step 1 Click or click on the configuration page, and then select **DEVICE**.

Step 2 Select the root node in the resource tree, and then click the **Device List** tab.

Figure 8-4 Device list

<input type="checkbox"/>	Channel No	State	Channel	Address/Regist	Port	User Name	Password	Manufacturer	Product Mode	Sn	Remote	Operate
<input type="checkbox"/>	1				37777	admin	*****	Private		4A05AC5...	1	
<input type="checkbox"/>	2				37715	admin	*****	Private		sim-37715...	1	
<input type="checkbox"/>	3				37715	admin	*****	Private		sim-37715...	2	
<input type="checkbox"/>	4				37715	admin	*****	Private		sim-37715...	3	
<input type="checkbox"/>	5				37715	admin	*****	Private		sim-37715...	4	
<input type="checkbox"/>	6				37777	admin	*****	Private		1J012FEA...	1	
<input type="checkbox"/>	7				37777	admin	*****	Private		5C0707AP...	1	
<input type="checkbox"/>	8				37777	admin	*****	Private		5C0707AP...	2	
<input type="checkbox"/>	9				37777	admin	*****	Private		5C0707AP...	1	
<input type="checkbox"/>	10				37777	admin	*****	Private		4K02337Y...	1	
<input type="checkbox"/>	11				37777	admin	*****	Private		4K02337Y...	2	
<input type="checkbox"/>	12		camera1		10000	admin	*****	Private	--	sim-37777...	1	
<input type="checkbox"/>	13		camera2		10000	admin	*****	Private	--	sim-37777...	2	
<input type="checkbox"/>	14		camera3		10000	admin	*****	Private	--	sim-37777...	3	
<input type="checkbox"/>	15		camera4		10000	admin	*****	Private	--	sim-37777...	4	
<input type="checkbox"/>	16		camera1		37716	admin	*****	Private	--	sim-37777...	1	
<input type="checkbox"/>	17		camera2	10.172.33.21	37716	admin	*****	Private	--	sim-37777...	2	

Total 17 Item(s) Show up to 20

Step 3 View details of connected devices, including IP address and serial number.

- In the **Status** column, indicates that the device is offline.
- In the **Status** column, indicates that the device is online.
- In the **Status** column, indicates that the device is in exception. Point to , and then you are prompted about the details of the exception, such as being uninitialized, device mismatch, and wrong password.

Step 4 (Optional) Click to set filtering conditions for search.

8.2.2.2 Changing IP Address

Modify IP address of the remote device connected or not connected to the Device.

8.2.2.2.1 Modifying IP of Unconnected Devices



- You can only modify the IP address of initialized devices.
- You can only modify the IP address of remote devices connected with private protocol.

Step 1 Click or click on the configuration page, and then select **DEVICE**.

Step 2 Click or click **Add**, and then select **Smart Add**.

Step 3 Click **Start Search**.

System starts to search and displays result.

Figure 8-5 Remote device

Add Device									
Smart Add		Manual Add	RTSP	Batch Import					
<input type="checkbox"/>	(0)	Initialization Sta...	Address	Product Model	Manufacturer	Port	Product Type	Sn	Operate
<input type="checkbox"/>		Initialized	192.168.1.100	IPC-HFW1234	Onvif	80	--	--	
<input type="checkbox"/>		Initialized	192.168.1.101	IPC-HFW1234	Onvif	80	--	--	
<input type="checkbox"/>		Initialized	192.168.1.102	IPC-HFW1234	Onvif	80	--	--	
<input type="checkbox"/>		Initialized	192.168.1.103	IPC-HFW1234	Private	37777	EVS	5K02166YAJ...	
<input type="checkbox"/>		Initialized	192.168.1.104	IPC-HFW1234	Private	37777	EVS	5K02166YAJ...	
<input type="checkbox"/>		Initialized	192.168.1.105	IPC-HFW1234	Private	37777	EVS	4M05A23YAJ...	
<input type="checkbox"/>		Initialized	192.168.1.106	IPC-HFW1234	Private	37777	EVS	4M05A23YAJ...	
Total 7 Item(s)			Show up to	50					
					<	<	1/1	>	>
Remaining Bandwidth/Total: 362.46 Mbps/ 1024 Mbps								Add	Cancel

Step 4 Select a remote device and then click **Modify IP**.

Figure 8-6 Modify IP (1)

Modify IP address
✕

Device Name	Sn	IP Address
camera46	XXXXXXXXXX	XXXX.XX.XX.XX

Static IP Address Incremental Value

Subnet Mask

Gateway

support Private, Onvif only

Step 5 Enter the static IP address, subnet mask, gateway, and incremental value.



- Enter incremental value only when multiple remote devices are modified. If you want to change IP addresses of several devices at the same time, system allocates IP address one by one according to your setting at the fourth bit of the IP address.
- If there is IP conflict when changing static IP address, device pops up IP conflict dialogue box. To change IP addresses in batches, system automatically skips the conflicted IP and begins the allocation according to the incremental value.

Step 6 Enter the username and password of remote device.



When you are changing several device IP addresses, make sure that the username and password of these remote devices are the same.

Step 7 Click **Next**.

The modification result is displayed.

Step 8 Click **OK** to complete the modification.

8.2.2.2 Modifying IP of Connected Devices



- You can only modify the IP address of initialized devices. For remote device initialization, see "5.4.1 Initializing Remote Device" for detailed information.
- You can only modify the IP address of remote devices connected through **Private, Onvif** or **Onvifs** protocol.
- To modify the IP address of connected devices one by one, see "8.2.2.3.2 Configuring Connection

Information".

- Step 1** Click or click on the configuration page, and then select **DEVICE**.
- Step 2** Select a remote device and then click **Modify IP**.

Figure 8-7 Modify IP (1)

- Step 3** Enter the IP address, subnet mask, gateway, and incremental value.



- Enter incremental value only when multiple remote devices are modified. If you want to change IP addresses of several devices at the same time, system allocates IP address one by one according to your setting at the fourth bit of the IP address.
- If there is IP conflict when changing static IP address, device pops up IP conflict dialogue box. To change IP addresses in batches, system automatically skips the conflicted IP and begins the allocation according to the incremental value.

- Step 4** Enter the username and password of remote device.



When you are changing several device IP addresses, make sure that the username and password of these remote devices are the same.

- Step 5** Click **Next**.
The result of IP modification is displayed.
- Step 6** Click **OK**.

8.2.2.3 Configuring Remote Devices

Set remote device property, connection information, and video parameters.



The page displayed might vary with remote devices. See the actual page for detailed information.

8.2.2.3.1 Configuring Device Property

Set remote device name, and view device information.

Step 1 Click or click on the configuration page, and then select **DEVICE**.

Step 2 Select a remote device on the left panel and then click **Property** tab.

Figure 8-8 Property

Step 3 Set parameters.

Table 8-2 Property parameters description

Parameters	Description
Name	Set remote device name. Enable Sync to remote device and save the settings to synchronize new name to the remote device.
Description	Input remote device description.
Device info	Displays remote device information. It includes remote device type, SN, MAC address, video in/out, audio in/out, alarm in/out, and system version.

Step 4 Click **Save**.

8.2.2.3.2 Configuring Connection Information

Set connection information of remote device, such as IP address and port number.

Step 1 Click or click on the configuration page, and then select **DEVICE**.

Step 2 Select a remote device on the left panel and then click the **Connection** tab.

Step 3 Change IP address.

- 1) Click of the corresponding address.
- 2) Enter IP address, subnet mask and gateway.
- 3) Click **Test** to test whether the IP address is valid.

Figure 8-9 Modify IP

4) Click **OK** to save setting.

Step 4 Change port number.

1) Click of the corresponding port.

Figure 8-10 Port

2) Change port number.

3) Click **OK** to save setting.

Step 5 Set other parameters.

Table 8-3 Connection parameters description

Parameters	Description
Manufacturer	Displays the connection protocol of the remote device.
Username	Enter username and password of remote device.
Password	
Link type	Displays link type of the system and remote device. It is self-adaptive.
Cache strategy	Set cache strategy of remote device video stream. <ul style="list-style-type: none"> • Self-adaptive: System automatically adjusts video stream cache status according to the network bandwidth. • Realtime: Guarantee video real-timeness. When the network bandwidth is not sufficient, the video might not be fluent. • Fluency: Guarantee video fluency. When the network bandwidth is not sufficient, the video might not be clear.

Step 6 Click **Save**.

Step 7 (Optional) Click , and then you can go to the web interface of the remote device.



On the local interface of the Device, you cannot click to go to the web interface of the remote device.

8.2.2.3.3 Configuring Video Parameters

Set different video parameters according to different bit stream types based on the bandwidth.

Step 1 Click or click on the configuration page, and then select **DEVICE**.

Step 2 Select a remote device on the left panel and then click **Video** tab.

Figure 8-11 Video

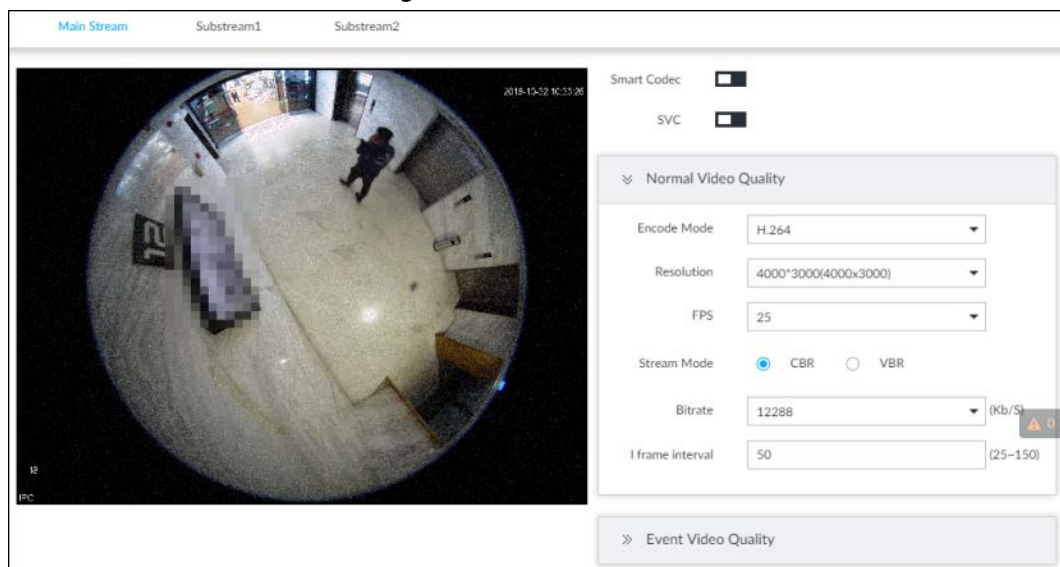



Step 3 Set main stream, sub stream 1, or sub stream 2.

Step 4 Set general video quality parameters.

Table 8-4 Video parameters description

Parameters	Description
Smart Codec	Enable this function to enhance performance of video compression and thus reduce storage space requirement. This function is only available for main stream.
SVC	Select the checkbox to enable SVC function. Select 1 or 2 from the drop-down list on the right. The default setup is 1, there is no scaled encoding. SVC refers to the scaled video coding. It can split the video stream to basic stream and enhanced scale.

Parameters	Description
Encode mode	Set video encode mode. <ul style="list-style-type: none"> • H.264: It is a highly compressed video encoding or encoding standard. At the same video quality, it has increased the compression rate by 2X compared with the MPEG-2. • H.265: It is a new video encode standard coming after H.264. It has improved the complicated relationship among bit stream, encode quality, latch and algorithm on the previous standard. It can get the best encoding.
Resolution	Set video resolution. The higher the resolution is, the better the video quality is.  Different series products support different resolutions. See the actual page for detailed information.
FPS	It is to set the frame amount displayed at each second. The higher the frame rate is, the more vivid and fluent the video is.
Stream mode	Set video bit stream control mode. <ul style="list-style-type: none"> • CBR: The bit stream changes slightly. The bit stream is near the value you set here. • VBR: The bit stream might change according to the environment.
Quality	Set video quality. It includes low, middle, high.  It is null when the stream mode is CBR.
Bitrate	Set video bitrate. <ul style="list-style-type: none"> • Main stream: In the Bit Rate list, select a value or enter a customized value to change the image quality. The bigger the value is, the better the image will become. • Sub stream: In CBR mode, the bit stream changes around the value you set. In VBR mode, it changes according to the bit stream value, but its max value is near the specified value.
I frame interval	Set the P frame amount between two I frames. Usually we recommend it is the 2X of the frame rate.

Step 5 Enable **Event Video Quality** and set FPS and stream mode.





Event video quality is for main stream only.

Step 6 Click **Save**.

8.2.2.3.4 Configuring OSD

Set time and channel information overlay on the video.

Step 1 Click , or click  on the configuration page, and then select **DEVICE**.

Step 2 Select a remote device on the left panel and then click **OSD** tab.

Figure 8-12 OSD

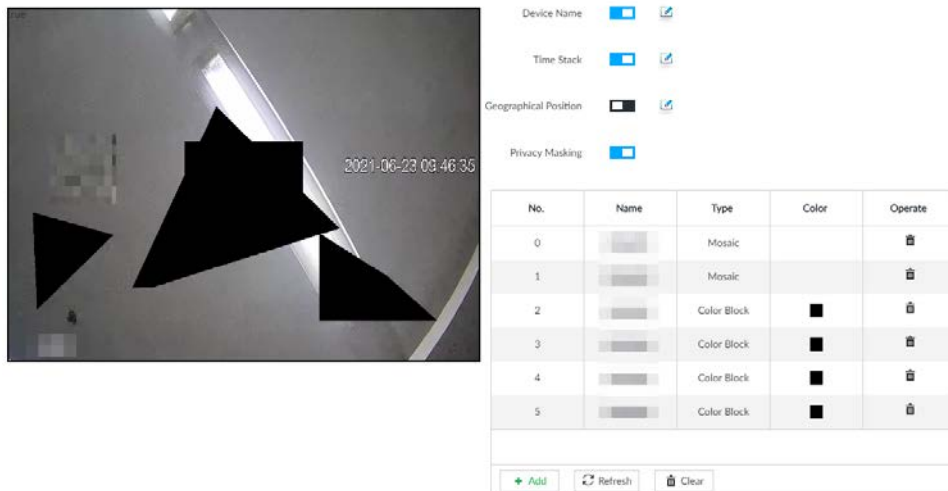

Step 3 Enable OSD information according to actual requirements.

- Set device name
 1. Click to enable OSD of device name.
 2. Click
 3. Enter device name.

Figure 8-13 Device name

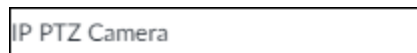

4. Drag the text box to the proper position.
5. Click to save the OSD information.

- Set device name
 1. Click to enable OSD of time.
 2. Click .

Figure 8-14 Time

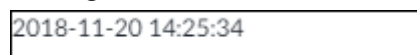

3. Drag the text box to the proper position.
4. Click to save the OSD information.

- Set geographical position
 1. Click to enable OSD of geographical position.
 2. Click .
 3. Enter the geographical position information.



- ◇ Click to adjust the alignment of text boxes.
- ◇ Click to create a text box.
- ◇ Click to delete a text box.

Figure 8-15 Geographical position



4. Drag the text box to the proper position.
 5. Click to save the OSD information.
- Set privacy masking



This function is available only when the camera supports privacy masking.

1. Click to enable privacy masking.
2. Click **Add**, select the masking type and color, and then draw mosaic or color blocks in the image as needed.
3. Drag blocks to the proper position.
4. Click to save the OSD information.

Step 4 Click **Save**.

8.2.2.3.5 Configuring Audio Parameters

Step 1 Click or click on the configuration page, and then select **DEVICE**.

Step 2 Select a remote device on the left panel and then click **Audio** tab.

Figure 8-16 Audio

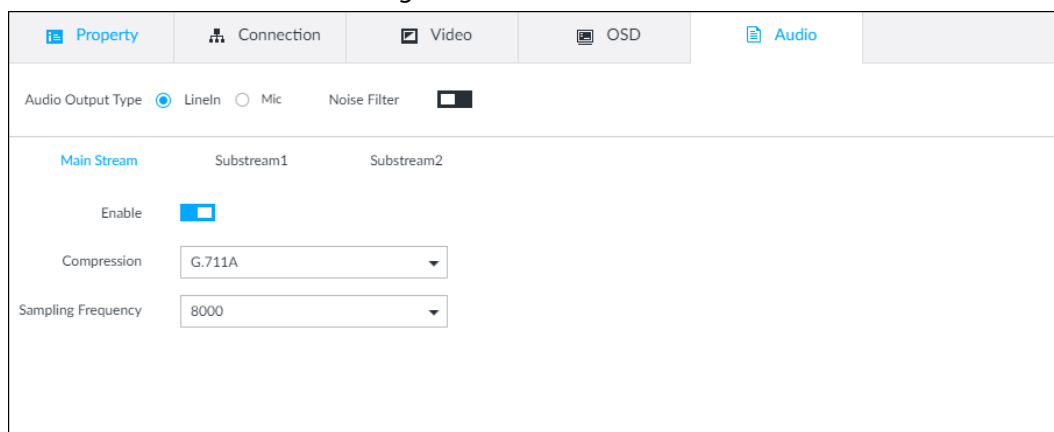

Step 3 Select an audio output type.

- LineIn: The Device acquires audio signals through external audio device.
- Mic: The Device acquires audio signals through internal mic.

Step 4 Click to enable Noise Filter.

Step 5 Click the **Main Stream**, **Substream1** or **Substream2** tab, and then configure the parameters.

Table 8-5 Audio parameters

Parameter	Description
Compression	The audio encoding mode set here applies to both audio streams and voice talks. We recommend leaving it as default.
Sampling Frequency	The number of samples of a sound that are taken per second. The higher the value, the more accurate the digital representation of the sound can be.

Step 6 Click **Save**.

8.2.2.4 Exporting Remote Devices in Batches

Export the added remote device. When the device restores factory default settings or information of remote device is lost, export information of remote device to recover quickly.



See "5.4.2 Adding Remote Device" for detailed information.

Step 1 Click or click on the configuration page, and then select **DEVICE**.

Step 2 Click at the lower-left corner.



Click **Download Template** to download template file of the remote device, and add remote device through the template.

Figure 8-17 Export

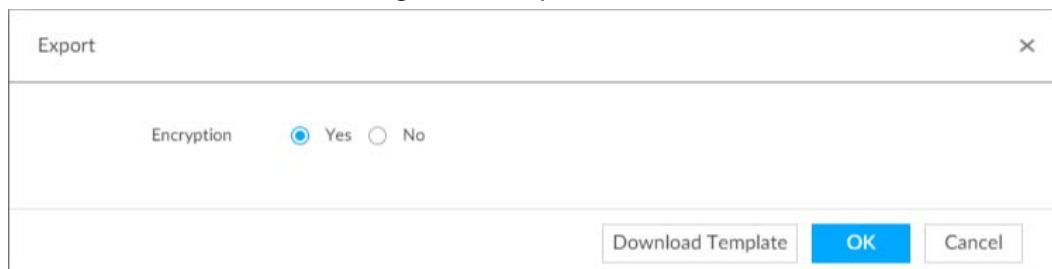

Step 3 Select encryption or not.

- If you select **Yes**, the system exports encrypted .backup file.
- If you select **No**, the system exports .csv file, which can be opened with Excel. The exported .csv file contains IP address, port number, channel number, channel name, manufacturer and username (excluding password) of the remote device.



When unencrypted file is exported, keep the file properly to avoid data leakage.

Step 4 Click **OK**.

Step 5 Click **Save**.

File path might be different depending on your operations.

- On PCAPP, click , select **Download** to view file saving path.
- Select file saving path during local operation.
- During web operations, files are saved under default downloading path of the browser.

8.2.2.5 Importing Remote Devices in Batches

Import devices in batches by using the template.

On the **Device List** page, click **Batch Import** to go to the **Add Device** page. On the **Add Device** page, click the **Import CSV File** tab.

8.2.2.6 Connecting Remote Devices

On the **Device** page, view connection status of remote device in the device list.

When the remote device name and icon is black, SDT5A403 for example, it means the remote device is online. When they are gray, C2 8249 for example, it means the remote device is offline.

- Right-click the offline device, and then select **Connect** to connect the device.
- Right-click the online device, and then select **Disconnect** to disconnect the device.
- Right-click the online device, and then select **Open WEB** to go to the web interface of the device.

Figure 8-18 Device list

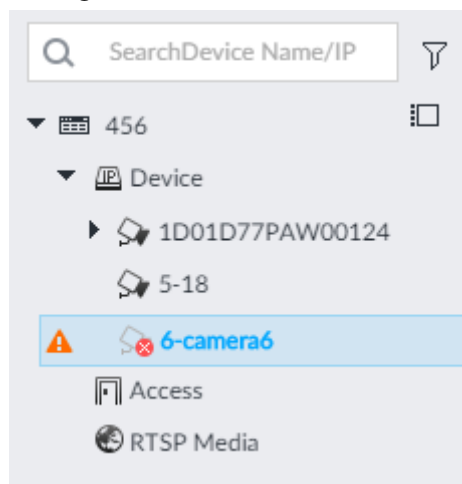

8.2.2.7 Deleting Remote Devices

On the **Device** page, delete the registered remote device.

- Delete one by one:
 - ◇ Select a remote device and then click to delete.
 - ◇ On the **Device List** page, right-click a remote device and then click **Delete**.
 - ◇ On the **Device List** page, select a remote device, and then click .
 - ◇ On the **Device List** page, select a remote device, and then click **Delete**.
- Batch delete:
 - ◇ Click , device list displays checkbox for you to select multiple remote devices. Click to delete the selected devices.
 - ◇ On the device list, click one remote device, press Ctrl to select other remote devices and then click to delete them.
 - ◇ On the device list, click one remote device, press Shift and then click another remote device, it is to select all remote devices between these two, and then click to delete them.
 - ◇ On the **Device List** page, select multiple remote devices, and then click **Delete**.

8.2.2.8 Changing Device Password

Change passwords of connected devices.



You can only modify devices successfully connected to IVSS via private protocol.

Step 1 Click or click on the configuration page, and then select **DEVICE**.

Step 2 Select a remote device and then click **Change Password**.

Figure 8-19 Modify password

Device Name	Sn	IP Address
1D01D77PAW00124	sim-3777751738	

Using current device password and password protection information

admin

Password It is 8 to 32-digit containing letter(s), number(s), symbol(s). It contains at least two types.

Confirm Password

support Private only

Next Cancel

Step 3 Keep Using current device password and password protection information disabled. means that the function is disabled.

Step 4 Enter the new password, and then confirm it as required.

Step 5 Click **Next** button.

The result of password modification is displayed.

Step 6 Click **OK**.

Step 7 (Optional) On the **Device List** page, double-click the device name, and then you can modify device name.

8.3 Network Management

Click or click on the configuration page, select **NETWORK**. You can set basic network parameters and application.

Figure 8-20 Network management

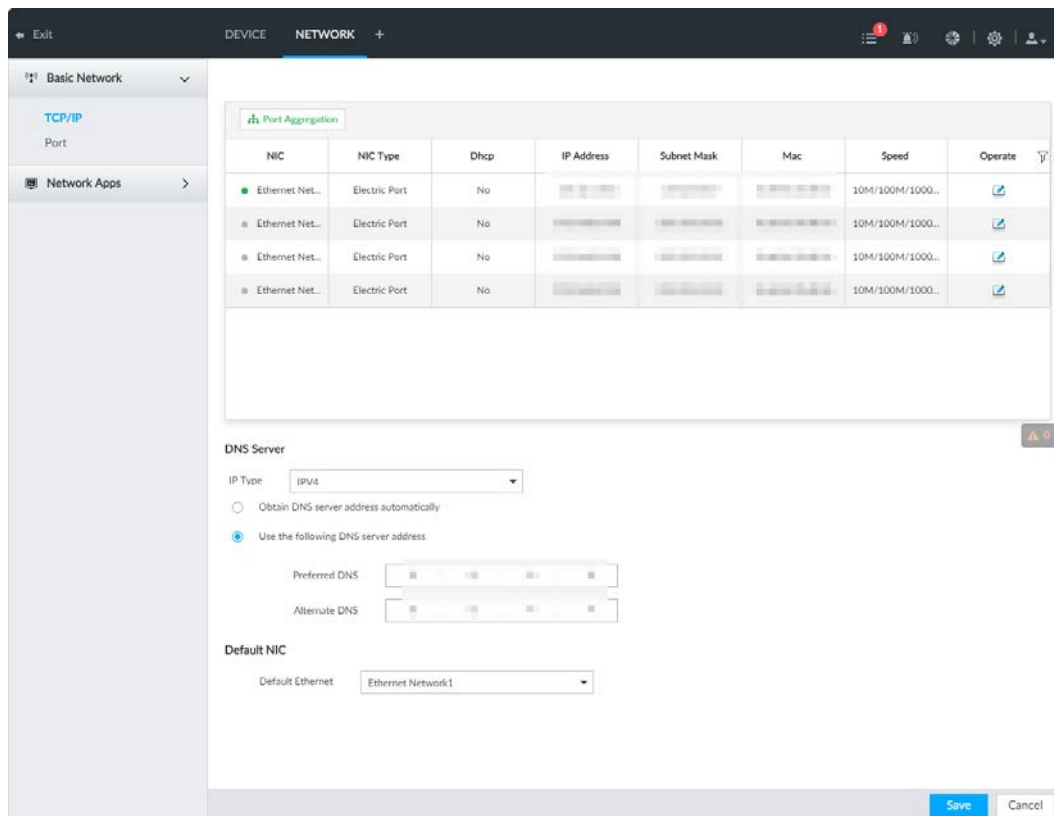

8.3.1 Basic Network

Set basic network parameters of the device, such as IP address, port aggregation and port number, to connect with other devices in the network.

8.3.1.1 Configuring IP Address

Set device IP address, DNS server information and other information according to network planning.



Device has 4 Ethernet ports by default. Make sure that at least one Ethernet port has connected to the network before you set IP address.

Step 1 Click or click on the configuration page, and then select **NETWORK > Basic Network > TCP/IP**.



Click to view the NIC parameter information.

Figure 8-21 TCP/IP

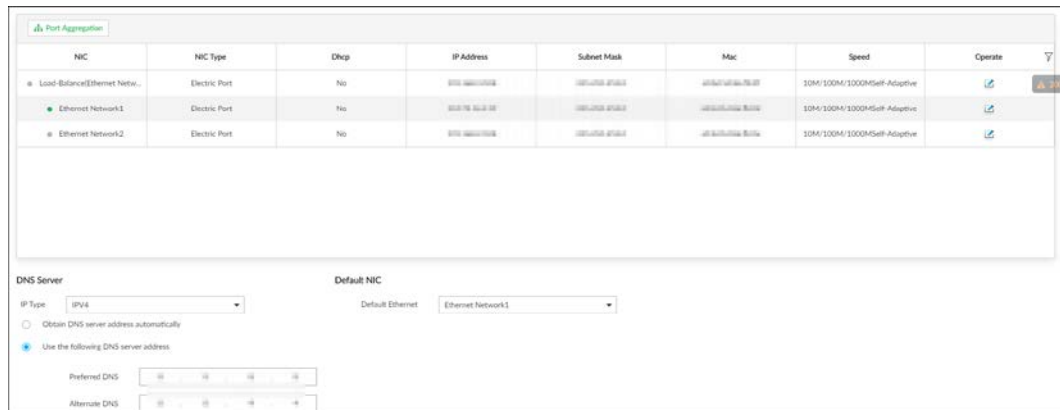

Step 2 Click of the corresponding NIC to edit network parameters.

Figure 8-22 Edit Ethernet network

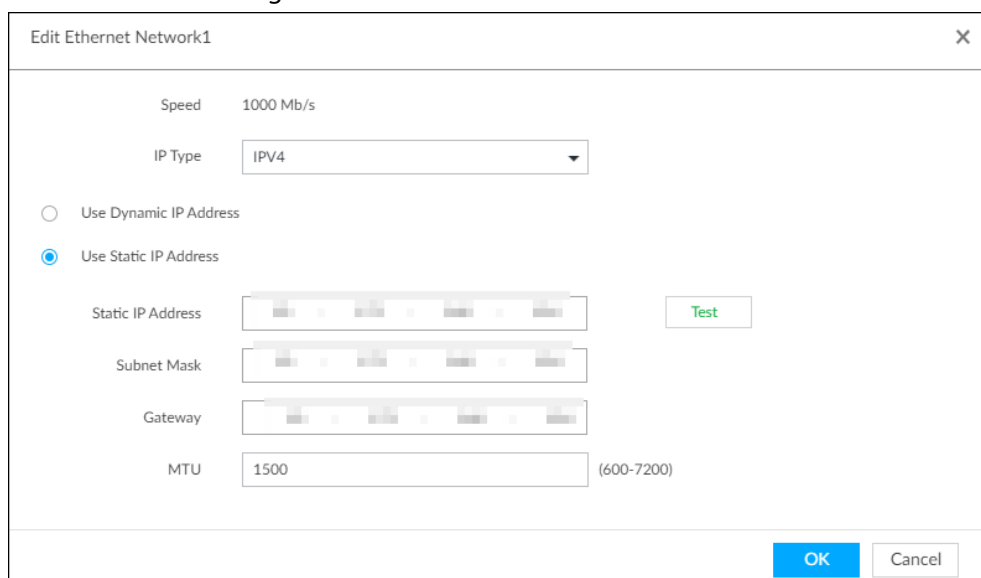

Step 3 Set parameters.

Table 8-6 TCP/IP parameters description

Parameters	Description
Speed	Current NIC max network transmission speed.
IP Type	Select IPv4 or IPv6.
Use Dynamic IP Address	When there is a DHCP server on the network, check the box to use dynamic IP address, system can allocate a dynamic IP address to the device. There is no need to set IP address manually.
Use Static IP Address	Check the box to use static IP address. Set static IP address, subnet mask and gateway. Set a static IP address for the device.
Test	Test whether the IP address is valid.

Parameters	Description
MTU	<p>Set NIC MTU value. The default setup is 1500 Byte.</p> <p>We recommend you to check the MTU value of the gateway first and then set the device MTU value equal to or smaller than the gateway value. It is to reduce the packets slightly and enhance network transmission efficiency.</p> <p></p> <p>Please be advised that changing MTU value might result in NIC reboot, network offline and affect current running operation.</p>

Step 4 Click **OK**.

Go back to **TCP/IP** page.

Step 5 Set DNS server information.

You can select to get DNS server manually or input DNS server information.



This step is compulsive if you want to use domain service.

- Check the box to auto get DNS server address, device can automatically get the DNS server IP address on the network.
- Check the box to use the following DNS server addresses, and then input primary DNS and alternate DNS IP address.

Step 6 Set default NIC.

Select default NIC from the drop-down list.



Make sure that the default NIC is online.

Step 7 Click **Save**.

8.3.1.2 Port Aggregation

Bind multiple NIC to create one logic NIC and use one IP address for peripheral device. The bonded NIC can work as the specified aggregation mode to work. It enhances network bandwidth and network reliability.

System supports configuring load balance, fault tolerance, and link aggregation.



Table 8-7 Aggregation mode description

Aggregation mode	Description
Load balance	<p>Device has bonded several NICs at the same time and use one IP address to communicate with the external device. The bonded NICs are working together to bear the network load.</p> <p>The load balance mode adds the network throughput data amount and enhances network flexibility and availability. In this mode, the network is offline once all NICs break down.</p>

Aggregation mode	Description
Fault-tolerance	<p>In this mode, device has bonded several NICs and set one NIC as the main card and the rest NICs are the alternative NICs. Usually, only the main NIC card is working. System can automatically enable other alternate cards to work when the main card breaks down.</p> <p>Fault-tolerance is a network mode to enhance NIC reliability. In this mode, the network is offline once all NICs break down.</p>
Link aggregation	<p>Device has bonded several NICs and all NICs are working together to share the network load. System allocates data to each NIC according to your allocated strategy. Once the system detects that one NIC breaks down, it stops sending data with this NIC, and then system transmits the data among the rest NICs. System calculates transmission data again after malfunctioning NIC resumes work.</p> <p>In this mode, the network is offline once all bonded NICs are malfunctioning.</p> <p> Make sure that the switch supports link aggregation and you have set the link aggregation mode.</p>

8.3.1.2.1 Binding NIC

System supports load balance, fault-tolerance, and link aggregation. Select bind mode according to your actual requirements.

Step 1 Click  or click  on the configuration page, and then select **NETWORK > Basic Network > TCP/IP** .

Step 2 Bind NICs.

- 1) Click **Port Aggregation**.
- 2) Select the NICs you want to bind.
- 3) Select an aggregation mode.
- 4) Click **Port Aggregation**.



The setting page varies depending on the aggregation mode you have selected. The following figure is the load balance setting page.

Figure 8-23 Edit load balance

5) Set parameters.

Table 8-8 TCP/IP parameters description

Parameters	Description
Speed	Maximum network transmission speed of current NIC.
IP Type	Select IPv4 or IPv6.
Use Dynamic IP Address	When there is a DHCP server on the network, check the box to use dynamic IP address. System can allocate a dynamic IP address to the device. There is no need to set IP address manually.
Use Static IP Address	Check the box to use static IP address. Set static IP address, subnet mask and gateway. It is to set a static IP address for the device.
Test	Test whether the IP address is valid.
MTU	<p>Set NIC MTU value. The default setup is 1500 Byte.</p> <p>We recommend you to check the MTU value of the gateway first and then set the device MTU value equal to or smaller than the gateway value. It is to reduce the packets slightly and enhance network transmission efficiency.</p> <p> Please be advised that changing MTU value might result in NIC reboot, network offline and affect current running operation.</p>

6) Click **OK**.

Go back to **TCP/IP** page.

Step 3 Click **Save**.

System pops up a confirmation box.

Step 4 Click **OK**.

The binding card information becomes activated after reboot operation.

8.3.1.2.2 Cancelling Binding NIC

Cancel port aggregation and allow the bonded NICs to work as independent card.

Step 1 Click or click on the configuration page, and then select **NETWORK > Basic Network > TCP/IP**.

Step 2 Select a bonded NIC.

Step 3 Click **OK**.
System splits the bonded NIC.



After splitting NIC binding, the first NIC reserves the IP address configured during binding, while the rest NICs restore default IP addresses.

8.3.1.3 Setting Port Number

Set device port number.

Step 1 Click or click on the configuration page, and then select **NETWORK > Basic Network > Port**.

Figure 8-24 Port

Step 2 Set parameters.



Log in again after modifying parameters except **Max Connection**.

Table 8-9 Connection setting parameters description

Parameters	Description
Max Connection	The allowable maximum clients accessing the Device at the same time, such as web, PCAPP, and Platform. Select a value between 1 and 128. The default value setting is 20.
TCP Port	Set according to the actual requirements. The default value is 37777. The value ranges from 1025 to 65535.
RTSP Port	Set according to the actual requirements. The default value is 554. The value ranges from 1 to 65535.

Parameters	Description
HTTP Port	Set according to the actual requirements. The default value is 80. The value ranges from 1 to 65535. If the value you set is not 80, please add the port number after the IP address when you are using browser to login the device.
HTTPS Port	Set according to the actual requirements. The default value is 443. The value ranges from 1 to 65535.
UDP Port	Set according to the actual requirements. The default value is 37778. The value ranges from 1025 to 65535.

Step 3 Click **Save**.

System reboots corresponding service of the port.

8.3.2 Network Apps

Set device network parameters, so that system can connect to other devices.

8.3.2.1 P2P

P2P is a peer to peer technology. You can scan the QR code to download cellphone APP without DDNS service or the port mapping or installing the transmission server. After register the device to the APP, you can view the remote video, playback record file and so on.



- Make sure that the system has connected to the network. Otherwise, the P2P function is null.
- When using the P2P function, we will collect device information such as IP address, MAC address, name and serial number. The collected information is only used for remote access.



Step 1 Click  or click  on the configuration page, and then select **NETWORK > Network Apps > P2P**.

Figure 8-25 P2P



Step 2 Click to enable P2P function.

Step 3 Click **Save**.

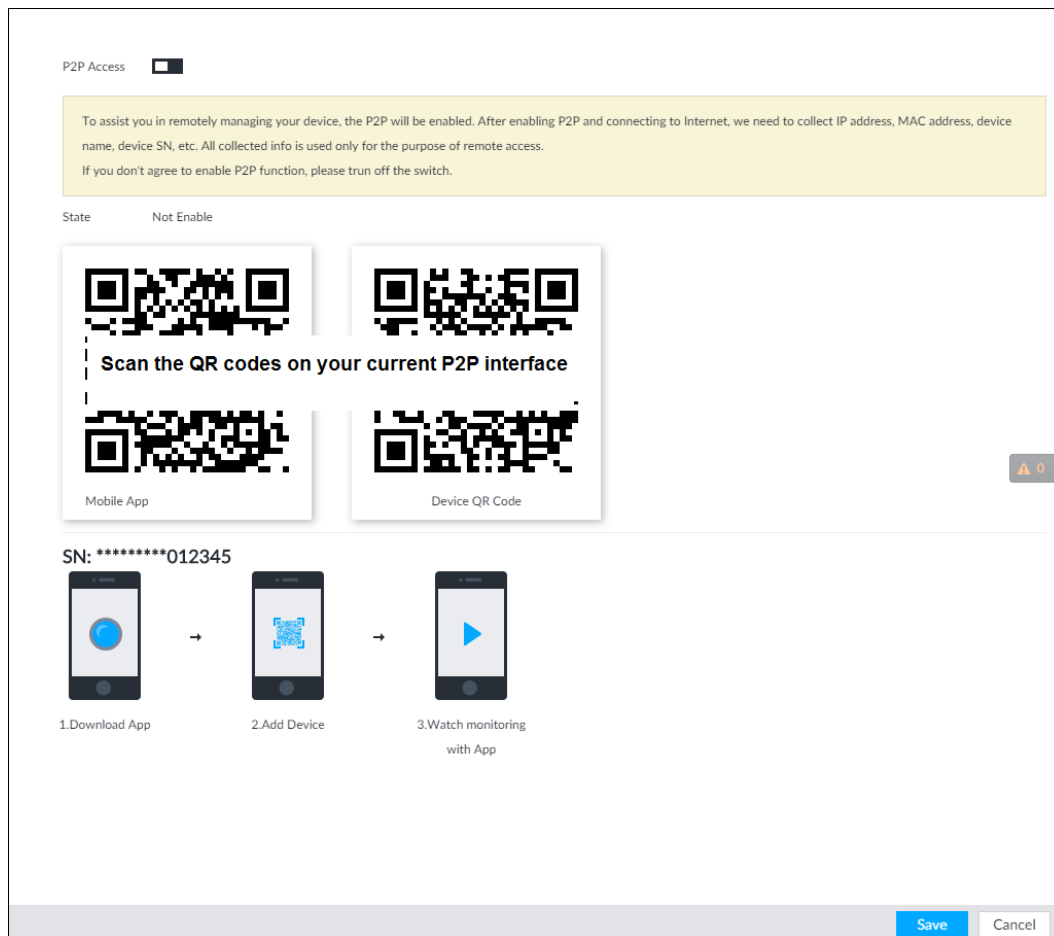
After the configuration, you can register a device to the APP to view remote video, playback record file, and so on. See corresponding cellphone APP for detailed information.



After successfully connected to the P2P, the status displayed as **Success**.

8.3.2.2 DDNS

After setting DDNS parameters, when IP address of the Device changes frequently, the system dynamically updates the relation between domain name and IP address on DNS server. You can use domain name to remotely access the Device, without need to note down IP address.

8.3.2.2.1 Preparation

Confirm whether IVSS supports the DDNS Type and log in the website provided by the DDNS service provider to register the information such as domain from PC located in the WAN.



After you have registered and logged in the DDNS website successfully, you can view the information of all the connected devices under this username.

8.3.2.2.2 Procedure

Step 1 Click or click on the configuration page, and then select **NETWORK > Basic Network > DDNS**.

Figure 8-26 DDNS

Step 2 Click to enable DDNS function.



After enabling DDNS function, the third-party server might collect your device information. Pay attention to privacy security.

Step 3 Set the corresponding parameters.

Table 8-10 DDNS setting parameters description

Parameters	Description
DDNS Type	Name and address of DDNS service provider. <ul style="list-style-type: none"> • Dyndns DDNS: members.dyndns.org • NO-IP DDNS: dynupdate.no-ip.com • CN99 DDNS: members.3322.org
Server Address	Name and address of DDNS service provider. <ul style="list-style-type: none"> • Dyndns DDNS: members.dyndns.org • NO-IP DDNS: dynupdate.no-ip.com • CN99 DDNS: members.3322.org
Domain	The domain name for registering on the website of DDNS service provider.
User Name	Enter the username and password obtained from DDNS service provider. You need to register (including username and password) on the website of DDNS service provider.
Password	

Parameters	Description
Update Circle	Enter the amount of time that you want to update the DDNS.
Current WAN IP	Displays the WAN IP address of IVSS.
Status	Displays DDNS registration result or update status.

Step 4 Click **Save**.

After successful configuration, enter domain name in address bar of the browser or PCAPP, and press Enter key to access the IVSS.

8.3.2.3 Email

Configure email information, and enable alarm linked email. When NVR has alarm events, the system automatically sends emails to the user.



Device data will be sent to specific servers after the email function is enabled. Be cautious.





Step 1 Click , or click  on the configuration page, and then select **NETWORK > Network Apps > Email**.

Figure 8-27 Configuring Email



Step 2 Click  to enable the email function.

Step 3 Set parameters.

Table 8-11 EMAIL parameter description

Parameters	Description
Email Server	Select email server type, including Customize, Gmail, Hotmail, and Yahoo.
Server Address	Enter email server address.
Encryption	Set the encryption type of email server, such as NONE, SSL, and TLS.  You are recommended to select TLS. Other encryption methods might not be safe.
Port	Enter the port number of email server.
Username and password	Enter the configured username and password of Email server.

Step 4 Add the information of mail receiver.

- 1) Click **Add**.
- 2) Enter a receiver email address.
- 3) Click **Add** or  to add other receiver email address.
 - Click  to delete the added receiver.
 - Select a receiver. The **Delete** button is displayed. Click **Delete** button to delete the selected receiver.

Step 5 Click **Save**.

Step 6 (Optional) Test the email sending function.

- 1) In **Test Mail**, select or enter a receiver email address.
- 2) Click **Send**.
 - When the configuration is correct, the system pops up a message of success, and the receiver will receive the test mail.
 - Otherwise, the system pops up a message of failure, and the receiver will not receive the test mail.

8.3.2.4 SNMP

After setting SNMP (Simple Network Management Protocol) and successfully connecting devices through relevant software tools such as MIB Builder, and MG-SOFT MIB Browser, you can directly manage and monitor devices on software tools.



- Install SNMP device monitoring and management tools, such as MIB Builder and MG-SOFT MIB Browser.
- Obtain the MIB file corresponding to the current version from technical support.



Step 1 Click  or click  on the configuration page, and then select **NETWORK > Network Apps > SNMP**.

Figure 8-28 SNMP (1)

SNMP configuration interface showing the following fields:

- Enable:
- SNMP Version:
- Port:
- Read Community:
- Write Community:
- Trap Server: . . .
- Trap Port: (1-65535)

Step 2 Click to enable the function.

Step 3 Select SNMP version.

- If you have selected SNMP V1/V2, see the previous figure.
- If you have selected SNMP V3, see the following figure.

Figure 8-29 SNMP(2)



SNMP configuration interface showing the following fields:

- Enable:
- SNMP Version: (Recommended)
- Port:
- Read Community:
- Write Community:
- Trap Server: . . .
- Trap Port: (1-65535)
- Read Only User:
- Read Authentication Type:
- Read Authentication Password:
- Read Encryption Type:
- Read Encryption Password:
- Read/Write User:
- R/W Authentication Type:
- R/W Authentication Password:
- R/W Encryption Type:
- R/W Encryption Password:

Buttons: Save, Cancel

Step 4 Set parameters. For Trap server address, enter the IP address of the PC that has MG-SOFT MIB Browser. Keep the other parameters as default.

Table 8-12 SNMP parameters

Parameters	Description
Port	Listening port of agent programs on the device.
Read Community, Write Community	Read or Write Community supported by the agent programs.  The name can only contain numbers, letters, underscores, and middle lines.
Trap Server	The destination address of Trap information sent by the agent program.
Trap Port	The destination port of Trap information sent by the agent program.
Read Only User	Set the username the read-only user. The read-only user can only have the read-only permission.  The name can only contain numbers, letters, and underscores.
Read Authentication Type	You can select MD5 or SHA. It is MD5 by default.
Read Authentication Password	The password must contain at least 8 digits.
Read Encryption Type	CFB-AES by default.
Read Encryption Password	The password must contain at least 8 digits.
Read/Write User	The username is private by default. If you log in using this username, you have the read-and-write permission.  The name can only contain numbers, letters, and underscores.
R/W Authentication Type	You can select MD5 or SHA. It is MD5 by default.
R/W Authentication Password	The password must contain at least 8 digits.
R/W Encryption Type	CFB-AES by default.
R/W Encryption Password	The password must contain at least 8 digits.

Step 5 Click **Save**.

8.3.2.5 Register

Register the device on designated proxy server, and client software visits the device through the proxy server.



Step 1 Click , or click  on the configuration page, and then select **NETWORK > Network Apps > Register**.

Figure 8-30 Register

Step 2 Click to enable the function.

Step 3 Set parameters.

Table 8-13 Register

Parameters	Description
IP Type	Select IP address of server for registration.
Server	In the Server box, enter the IP address of server for registration.
Port	Enter the port number of the server for registration.
Device ID	Enter Device ID to identify IVSS uniquely. Device ID shall be consistent with server configuration.

Step 4 Click **Save**.

8.3.2.6 UPnP

Through the UPnP (Universal Plug and Play) protocol, you can establish a mapping relationship between the LAN and the WAN, the WAN user can use the WAN IP address to directly access the Device in the LAN.



Device services and ports will be mapped to the public network after UPnP is enabled. Be cautious.



- Make sure that your PC has UPnP network services installed.
- Log in to the router and set the WAN port IP address of router.
- Enables the UPnP function on the router.
- Connect the Device to the router LAN (Local Area Network, LAN) port.
- Select **NETWORK > Basic Network > TCP/IP**, and then set the IP address to be the private-network IP of the router, or select DHCP to automatically obtain the IP address.

Step 1 Click or click on the configuration page, and then select **NETWORK > Network Apps > UPnP**.

Figure 8-31 UPnP

Port Mapping

State Search...

LAN IP

WAN IP

Port Mapping List

Service Name	Protocol	Internal Port	External Port	Operate
HTTP	TCP	80	8080	
TCP	TCP	37777	37777	
UDP	UDP	37778	37778	
RTSP	TCP	554	554	
RTSP	UDP	554	554	
SNMP	UDP	161	161	
HTTPS	TCP	443	443	

Step 2 Set parameters.

Table 8-14 UPnP parameters

Parameters	Description
Port Mapping	Click <input checked="" type="checkbox"/> to enable UPnP.
State	The status of port mapping.
LAN IP	The LAN IP address of the router. The IP address is automatically obtained after the mapping succeeds.
WAN IP	The WAN IP address of router. The IP address is automatically obtained after the mapping succeeds.
Port Mapping List	The list is consistent with the UPnP port mapping list on the router. <ul style="list-style-type: none"> Internal Port: The IVSS port to be mapped on the router. External Port: The WAN port of the internal port. <ul style="list-style-type: none"> When setting the external port, use the ports between 1024 and 5000, and do not use the well-known ports 1 to 255 and the system ports 256 to 1023, so as to avoid conflicts. When there are multiple devices within the LAN, properly plan the port mapping to avoid conflicts of WAN ports. When making a port mapping, make sure that the port you are mapping is not occupied or restricted. The TCP/UDP WAN and LAN ports must be consistent and cannot be modified.
Modification	Click , and then you can modify the external port.

Step 3 Click **Save**.

Enter `http://WAN IP: WAN port number` in the browser to access the Device with the

corresponding port number in the router network.

8.3.2.7 Multicast

When multiple users are viewing live video of the same device at the same time, it might cause failure due to limited bandwidth. To solve this problem, you can set a multicast IP address (224.0.0.0–239.255.255.255) for the Device.

Step 1 Click or click on the configuration page, and then select **NETWORK > Network Apps > Multicast**.

Figure 8-32 Multicast

Step 2 Click to enable multicast.

Step 3 Set parameters.

Table 8-15 Parameters

Parameters	Description
IP Address	Set the multicast IP address of the device (224.0.1.0–239.255.255.255).
Port	Set the multicast port (1025–65000).

Step 4 Click **Save**.

After configuring the multicast address and port, you can log in to the web or PCAPP client through the multicast protocol.

Take PCAPP for example. On the login page of PCAPP, select **Multicast** as the login type. PCAPP client will automatically obtain the multicast address and join the multicast group.

After login, you can view live videos through multicast protocol.

Figure 8-33 Log in through multicast

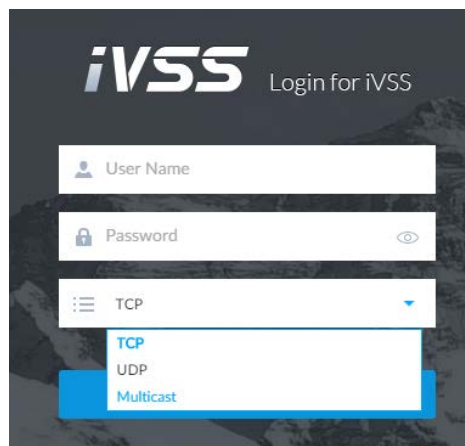

8.3.2.8 Alarm Center

You can configure the alarm center server to receive the uploaded alarm information.



Make sure that alarm center server is deployed.

Step 1 Click or click on the configuration page, and then select **NETWORK > Network Apps > Alarm Center**.

Figure 8-34 Alarm center

Step 2 Click to enable alarm center.

Step 3 Configure the parameters.

Table 8-16 Alarm center parameters

Parameter	Description
IP Type	Select the IP type of the alarm center server.
Server Address	The IP address and communication port of the alarm center server.
Port	
Auto Report Plan	Select time cycle and specific time for uploading alarm.

Step 4 Click **Save**.

8.3.2.9 Route Table

Configure the route table so that the system can automatically calculates the best path for data transmission.

Step 1 Click or click on the configuration page, and then select **NETWORK > Network Apps > Route Table**.

Step 2 Click **Add**.

Figure 8-35 Add route table

Add
✕

NIC Ethernet Network1

No. 1

IP Section

Subnet Mask

Gateway

OK
Cancel

Step 3 Enter the information.

Step 4 Click OK.

8.4 Event Management

Click or click on the configuration page, select **EVENT**.

On the page, configure alarm event, including alarm event of the Device and remote device.

- Select the root node in the resource tree on the left to set alarm event of the Device.
- Select remote device in the device tree on the left, to set alarm event of this remote device.



- The alarm event might be different depending on the model you purchased.
- means that the corresponding alarm event has been enabled.
- means that AI by camera has been enabled; means that AI by device has been enabled; means that both have been enabled.

Figure 8-36 Event management

Filter		DEVICE INFO		Face	Video Metadata	In	Vehicle	Crowd Dis...	Call Detec...	Smoking D...	P
Channel No.	State	Channel Name	Address/Regist ID								
1		Channel6	192.168.1.100								
2		camera2	192.168.1.101								
3		camera2	192.168.1.102								
4			192.168.1.103								
5		AI	192.168.1.104								
6			192.168.1.105								
7			192.168.1.106								

8.4.1 Alarm Actions

System can trigger the corresponding actions when an alarm occurs.



The supported actions might be different depending on the model you purchased.

On the alarm configuration page, click **Actions** to display actions. Configure actions according to your actual need.

- After setting actions, click **Save** on the page.
- After enabling actions, click  to disable the corresponding actions.

Table 8-17 Actions description

Actions	Description	Preparation
Record	The system links the selected remote device to record when there is a corresponding alarm event.	Remote device, such as IPC, has been added. See "5.4.2 Adding Remote Device" for detailed information.
Buzzer	The system activates a buzzer alarm when there is a corresponding alarm event.	-
Log	The system notes down the alarm information in the log when there is a corresponding alarm event.	
Email	The system sends alarm email to all added receivers when there is corresponding an alarm event.	Email configuration has been completed. See "8.3.2.3 Email" for detailed information.
Snapshot	The system takes snapshots of the linked channel when there is an alarm event.	-
Preset	The system links the selected remote device to rotate to the designated preset point when there is a corresponding alarm event.	PTZ device has been added, and preset point has been added. See "5.4.2 Adding Remote Device" for detailed information.
Local Alarm Output	When there is an alarm, system can trigger the corresponding device to generate alarm.	The Device is connected with alarm output device. See "3.4.1.4 Alarm Output".
Remote Device Alarm Output		The remote device has been added, and the remote device is connected with alarm output device. See "5.4.2 Adding Remote Device" for detailed information.
Access	When there is an alarm, system can trigger the corresponding access control device to open door and close door.	See "5.4.2 Adding Remote Device" for detailed information.

Actions	Description	Preparation
Voice Prompt	When there is an alarm, system can play the selected audio file.	Audio function has been configured. See "7.3.5 Voice Management" for detailed information.
Smart Tracking	Alarm is triggered when a tripwire or intrusion behavior is detected. If smart tracking action is configured, the PTZ camera automatically rotates to the target view to track it.	See "7.1.1.3.6 Smart Tracking".
Report Alarm	When an alarm occurs, the system reports the alarm to alarm center.	Alarm center has been enabled. For details, see "8.3.2.8 Alarm Center".
Audio and Light Alarm	When an alarm occurs, the system associates with the remote device to perform audio and light actions.	The camera that supports this function has been connected. For details, see "8.4.1.13 Audio and Light Alarm".

8.4.1.1 Record

Enable record control function. The system links the selected remote device to record when there is corresponding alarm event.



Make sure that the remote device, such as IPC, has been added. See "5.4.2 Adding Remote Device" for detailed information.

Step 1 Click **Actions**, and then select **Record**.

Figure 8-37 Record

Step 2 Set the time length of recording after the event moment.

Step 3 (Optional) Repeat Step 1–Step 2 to link multiple remote devices to record.

8.4.1.2 Buzzer

The system activates a buzzer alarm when there is corresponding alarm event.

Click **Actions** and select **Buzzer** to enable this function.

Figure 8-38 Buzzer

8.4.1.3 Log

Enable the log function. The system notes down the alarm information in the log when there is corresponding alarm event.

Click **Actions** and select **Log** to enable this function.

Figure 8-39 Log

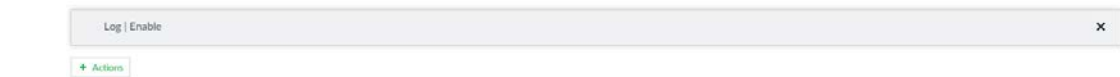

When log function is enabled, after an alarm is triggered, click **+** on **LIVE** page, select **MAINTAIN > Log > Event**.

8.4.1.4 Email

Enable Email function. The system sends alarm email to all added receivers when there is corresponding alarm event.



Make sure that the email configuration has been completed. See "8.3.2.3 Email" for detailed information.

Click **Actions** and select **Email** to enable this function.

Figure 8-40 Email

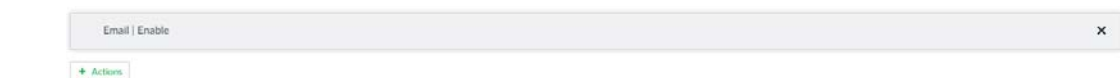

8.4.1.5 Preset

Set preset function. The system links the selected remote device to rotate to the designated preset point when there is corresponding alarm event.



Make sure that the PTZ device has been added, and preset has been added. See "5.4.2 Adding Remote Device" for detailed information.

Step 1 Click **Actions** and select **Preset**.

Figure 8-41 Preset



Step 2 Select PTZ device, and enter preset number.

Step 3 (Optional) Repeat Step 1–Step 2, and link multiple PTZ devices to turn to designated presets.

8.4.1.6 Snapshot

Set the snapshot linkage action for alarms, so that once an alarm happens, it will trigger a snapshot of the alarm.

Click **Actions**, and then select **Snapshot**.

Figure 8-42 Snapshot action

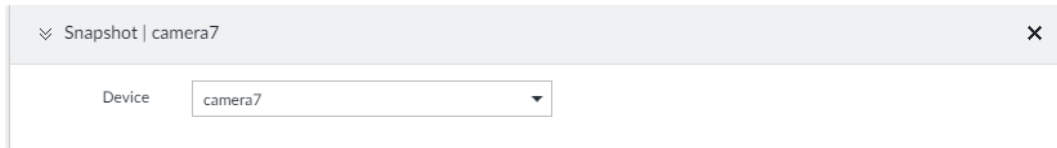

8.4.1.7 Local Alarm Out

Set local alarm output. System can trigger the corresponding alarm event when an alarm occurs.



Make sure that the Device is connected with alarm output device.

Step 1 Click **Actions** and select **Local Alarm Out**.

Figure 8-43 Local alarm out

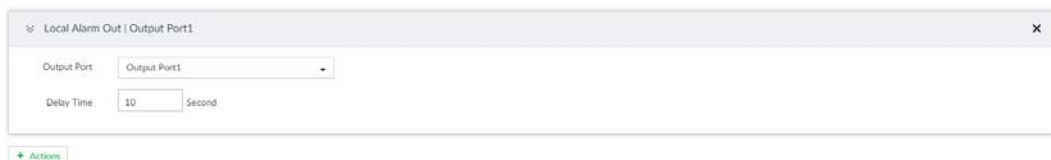

Step 2 Select alarm output port.

You can select multiple alarm output ports.

Step 3 Set delay time.

Set a delay time. After alarm event is ended, alarm will end after the delay time. You can configure from 0 seconds through 300 seconds, and the default value is 10 seconds.

8.4.1.8 Remote Device Alarm Output

Set remote device alarm output. The system can link the corresponding alarm output device to output alarm when an alarm occurs.



Make sure that the remote device has been added, and the remote device is connected with alarm output device. See "5.4.2 Adding Remote Device" for detailed information.

Step 1 Click **Actions** and select **Remote Device Alarm Output**.

Figure 8-44 Remote device alarm output settings

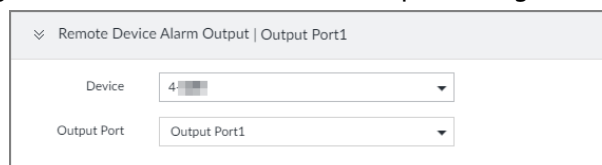

Step 2 Select a remote device and alarm output port.

You can select multiple alarm output ports.

Step 3 (Optional) Repeat Step 1–Step 2, and link multiple remote alarm output devices.

8.4.1.9 Access

Set access control function. When there is an alarm, system can trigger the corresponding access control device to open door and close door.



Make sure that access control device has been added. See "5.4.2 Adding Remote Device" for detailed information.

Step 1 Click **Actions** and select **Access**.

Figure 8-45 Access



Step 2 Select access control device.



Not all models support this function.

Step 3 (Optional) Repeat Step 1–Step 2, and link multiple access control devices.

8.4.1.10 Voice Prompt

Set voice prompt function. When there is an alarm, system can play the selected audio file.



Make sure that the voice function has been configured. For details, see "7.3.5 Voice Management".

Step 1 Click **Actions** and select **Voice Prompt**.

Figure 8-46 Voice prompt

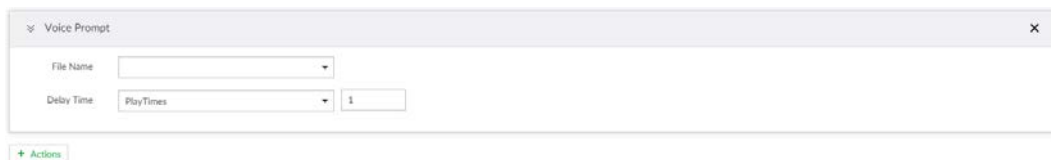

Step 2 In the **File Name** list, select the audio file that you want to play for this configured period.

Step 3 Set delay time.

- Play times: Select **Play Times** and enter the times to play the file. After the alarm event is ended, system will continue to play the voice file according to the play times.
- Duration: Select **Duration** and enter the delayed play duration. After the alarm event is ended, system will continue to play the voice file according to the duration.

8.4.1.11 Smart Tracking

Alarm is triggered when a tripwire or intrusion behavior is detected. If smart tracking action is configured, the PTZ camera automatically rotates to the target view to track it.



- Smart tracking is only available for AI by camera.
- Smart tracking is only available on the multi-sensor panoramic camera + PTZ camera.

On the event configuration page, select **Actions** > **Smart Tracking** to enable the action.

8.4.1.12 Report Alarm

Click **Actions** and then select **Report Alarm** to enable this function. Where there is an alarm, the system reports the alarm to alarm center.



Make sure that alarm center has been enabled. For details, see "8.3.2.8 Alarm Center".

8.4.1.13 Audio and Light Alarm

Set audio and light alarm for IVS detection. When there is an alarm, the system associates with the remote device to perform audio and light actions.



Audio and light alarm is available when AI by camera is used for IVS detection and the camera supports this function.

Step 1 Click **Actions** and select **Camera Audio** and **Remote Warning Light**.

Figure 8-47 Camera audio

Figure 8-48 Remote warning light

Step 2 Configure the parameters.

Table 8-18 Audio and light alarm parameters



Parameter		Description
Camera Audio	File Name	Select the audio file to be played when an alarm is triggered.
	Play Mode	Set the play times of audio file.
Remote Warning Light	Mode	Select Flicker or Always on .
	Flicker Frequency	When Flicker is selected as Mode , set the flicker frequency.
	Duration	Set how long the warning light flickers or keeps on after an alarm is triggered.

8.4.2 Local Device

Set IVSS alarm event, including abnormal event, device offline alarm, AI application, and local device alarm.

8.4.2.1 One-click Disarming

Disarm alarm linkage actions as needed to avoid interference caused by alarms.

Step 1 Click  or click  on the configuration page, and then select **EVENT**.

Step 2 Select the root node in the device tree.

Step 3 Select **Overview** > **Disarming**.

Figure 8-49 Disarming

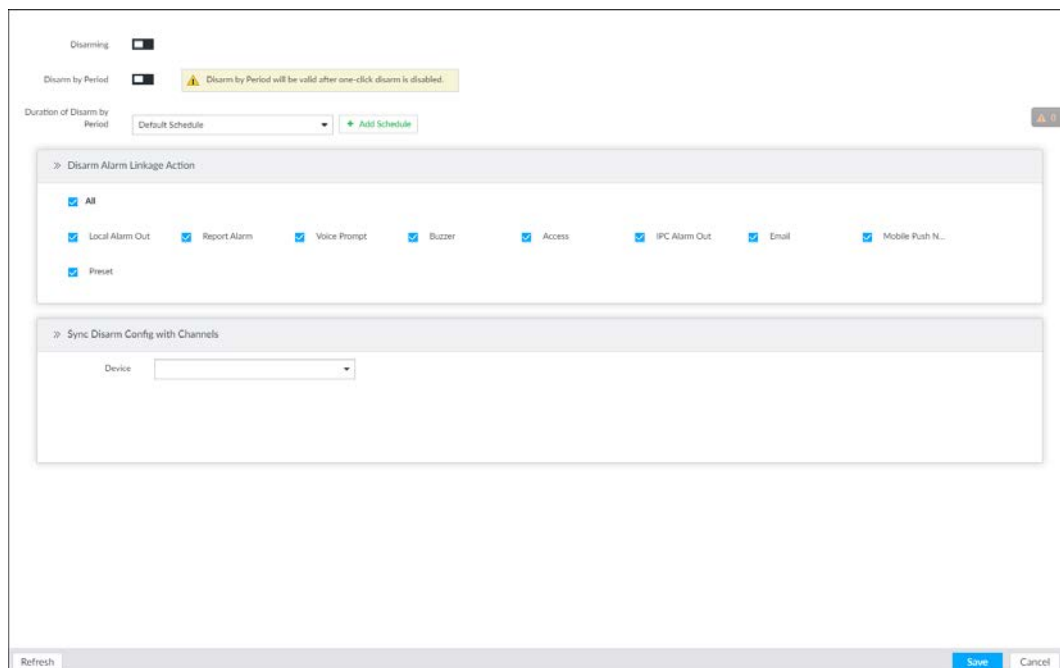

Step 4 Click to enable disarming.

Step 5 Cancel selecting alarm linkage actions as needed. The actions are selected by default.

Step 6 (Optional) Configure disarming by period.

- 1) Click to enable disarming by period.
- 2) Click **Add Schedule** to specify disarming schedule. The alarm linkage actions remain armed during unscheduled periods.
- 3) Click **Apply**.



After disarming by period is enabled, one-click disarming is disabled automatically.

Step 7 Configure sync disarming configuration with channels.

- 1) Click the drop-down list in the **Sync Disarm Config with Channels** section. The devices that support one-click disarming or disarming by period are displayed.
- 2) Select the device that you want to synchronize the disarming configuration with.



Step 8 Click **Save**.

8.4.2.2 Abnormal Event

Set the alarm mode when an abnormal event occurs.

The Device supports HDD, storage error, network, AI module, fan and power fault alarm.

Table 8-19 Abnormal event description

Name	Description
No HDD	System triggers an alarm when there is no HDD. It is enabled by default.
Storage error	System triggers an alarm in case of HDD error. It is enabled by default.
Storage full	System triggers an alarm when the used storage space reaches the pre-defined threshold. It is disabled by default.  The alarm is valid only when the storage mode is set as Stop on the STORAGE > VIDEO RECORDING > Basic page.
RAID exception	System triggers an alarm in case of RAID degrade, RAID broken or other RAID exceptions.
IP conflict	System triggers an alarm when its IP address conflicts with IP address of other device in the same LAN. It is enabled by default.
MAC conflict	System triggers an alarm when its MAC address conflicts with MAC address of other device in the same LAN. It is enabled by default.
Lock in	System triggers an alarm when an account login error has reached the threshold. At the same time, system locks current account. It is disabled by default.  Go to the Security page to set account error threshold. See "8.6.3 Safety Protection" for detailed information.
AI module temp	When AI module temperature is higher than the specified value, system triggers an alarm. It is enabled by default.
AI module offline	When AI module and system is disconnected, system triggers an alarm. It is enabled by default.
Fan speed alarm	When fan speed is abnormal, system triggers an alarm. It is enabled by default.
Power fault	When power supply is abnormal, system triggers an alarm. It is disabled by default.

Here we take AI module temp for example. For other events, the setting steps are similar. See the actual page for detailed information.

Step 1 Click , or click  on the configuration page, and then select **EVENT**.

Step 2 Select the root node in the device tree.

Step 3 Select **Abnormal Event > AI Module TEMP**.

Figure 8-50 AI module temp

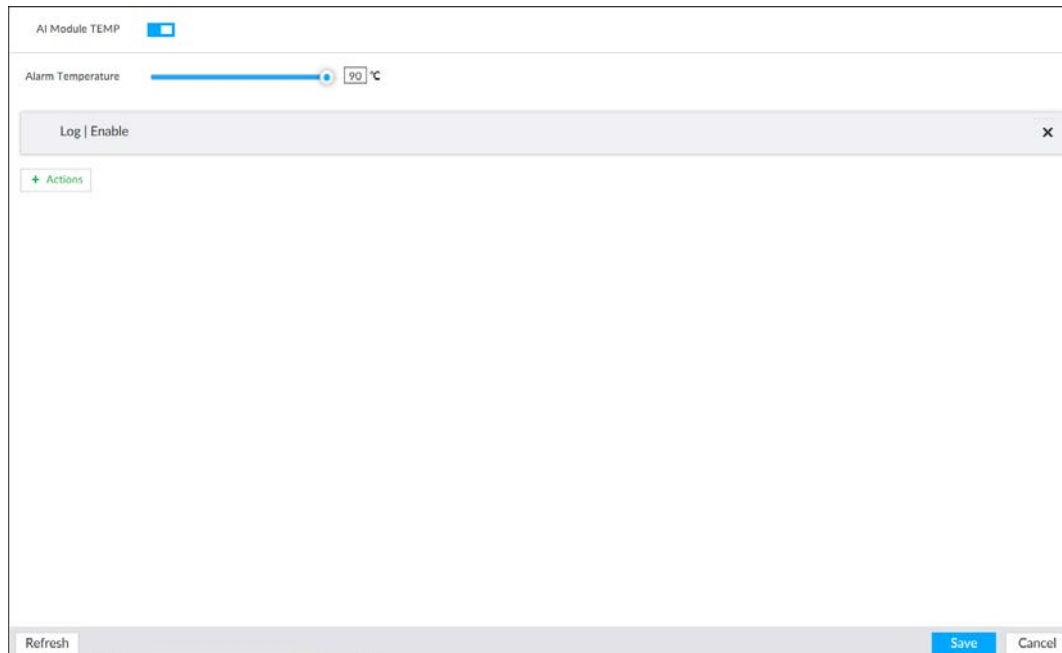

Step 4 Click to enable AI module temperature alarm function.

Step 5 Drag to set alarm temperature threshold.



The above step is for AI module temperature alarm only.

Step 6 Click **Actions** to set alarm actions. See "8.4.1 Alarm Actions" for detailed information.

Step 7 Click **Save**.

8.4.2.3 Offline Alarm

Set IVSS network offline alarm. If you have not set offline alarm for a specified remote device, once the remote device is disconnected from the system, system adopts IVSS alarm strategy to trigger an alarm.

Step 1 Click or click on the configuration page, and then select **EVENT**.

Step 2 Select the root node in the device tree on the left.

Step 3 Select **Device Offline** > **Device Offline**.

Figure 8-51 Offline alarm

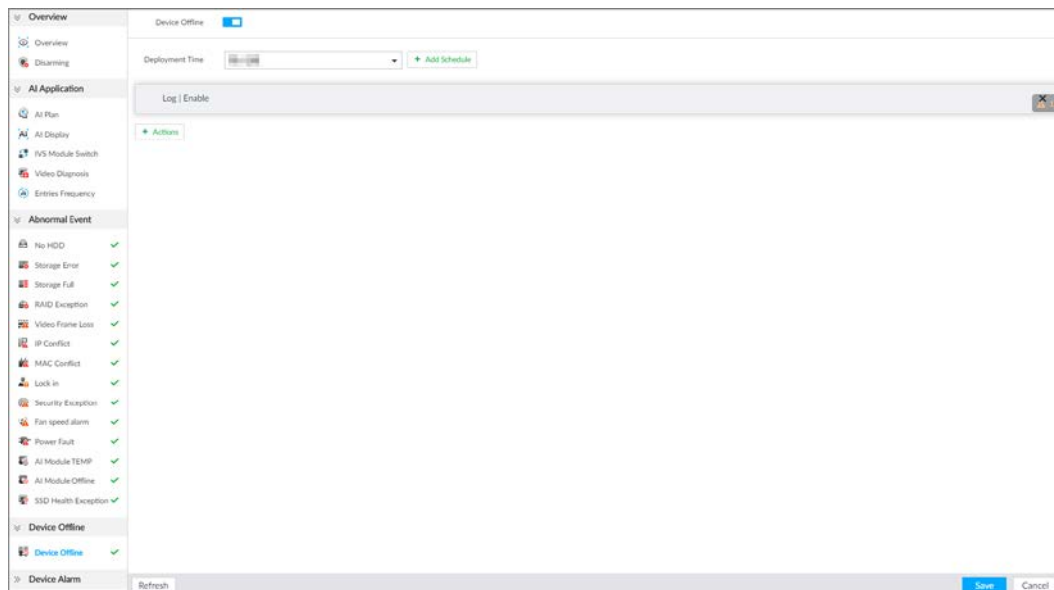

Step 4 Click to enable device offline alarm.

Step 5 Click **Deployment Time** to select schedule from the drop-down list.

After setting deployment period, system triggers corresponding operations when there is a motion detection alarm in the specified period.

- Click **View Schedule** to view detailed schedule settings.
- If the schedule is not added or the added schedule does not meet actual needs, click **Add Schedule**. See "8.8.4 Schedule" for detailed information.

Step 6 Click **Actions** to set alarm actions. See "8.4.1 Alarm Actions" for detailed information.

Step 7 Click **Save**.

8.4.2.4 Configuring AI Application

Configure AI detection result display strategy of the Device. If you have not set AI display settings for current remote device, the remote device inherits AI display mode of the Device.

8.4.2.4.1 Viewing AI Plan

After adding remote device, on IVSS, obtain AI detection type and status of the remote device.

On the **EVENT** page, select the root node in the device tree on the left. Select **AI Application > AI Plan > AI Plan**.

After installing the AI module, and the remote device supports AI detection, and you have enabled the AI detection function, you can view channel name of the remote device on the corresponding AI detection panel.



indicates that AI by camera is enabled; indicates that AI by device is enabled.

Figure 8-52 AI plan

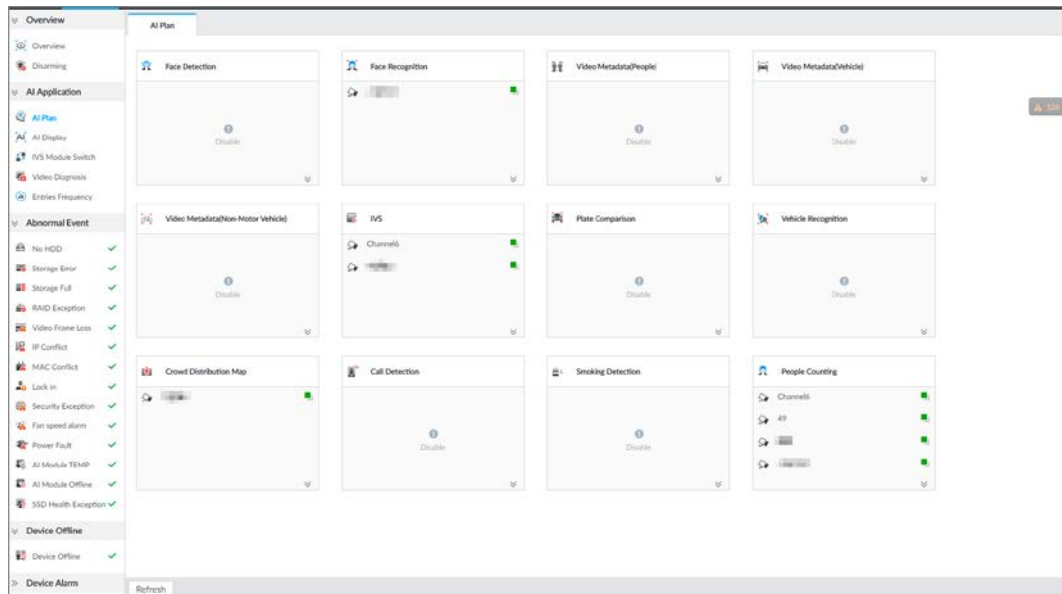

8.4.2.4.2 Setting AI Display

Set the property to be displayed in rule box and feature property panel. View AI detection result through smart preview, and support to display face, human and vehicle.



Take the procedure of configuring face detection AI display as an example. For other AI detection functions, the procedures are similar.

- Step 1** Click or click on the configuration page, and then select **EVENT**.
- Step 2** Select the root node in the device tree on the left.
- Step 3** Select **AI Application > AI Display > Face**.

Figure 8-53 Face

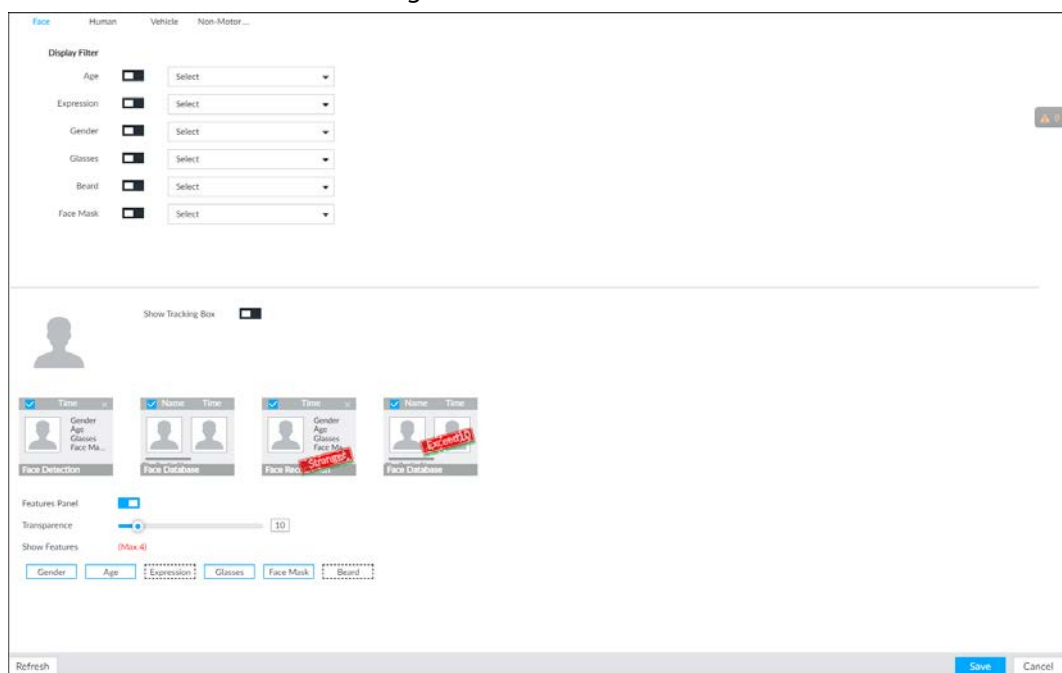

- Step 4** Configure display filter information.

After setting filter criteria, only the qualified detection result will be displayed. For example, enable Age, and then select youth from the drop-down list. The tracking box and the features panel only display the human face of the youth age.

- 1) Click to enable corresponding filter type.
- 2) Set display filter criteria. Click  to set the filter color.

Step 5 Click in the right of **Show Tracking Box** to enable.

After enabled, when the system detects face or human, tracking box will be shown beside the face or human in the view window.

Figure 8-54 Tracking box

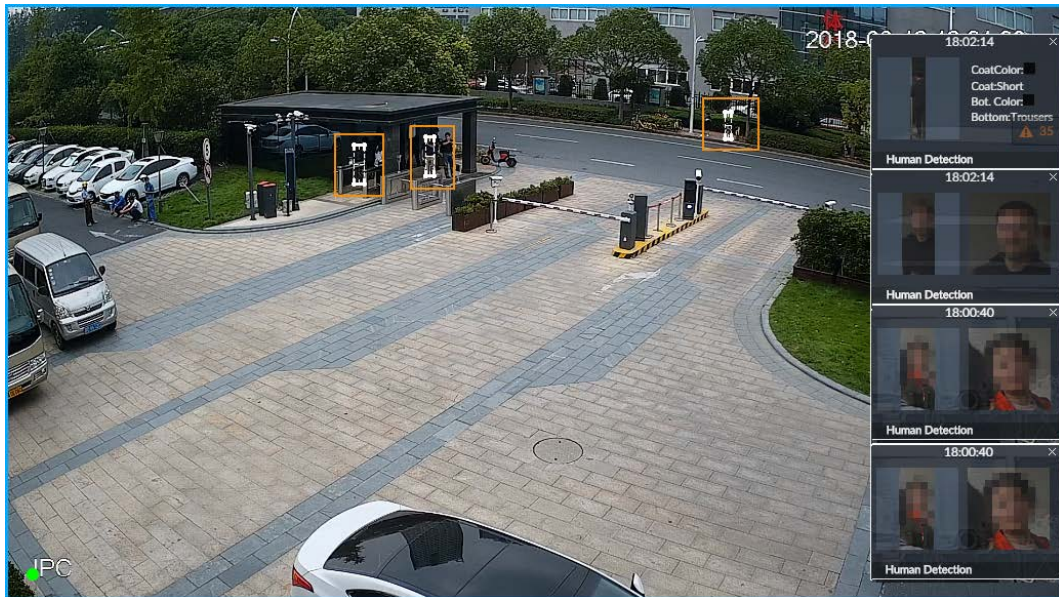

Step 6 Click in the right of **Features Panel** to enable, and select the features to be displayed on the **LIVE** page.

After enabled, there is a features panel on the right side of the view window.



- Drag  to adjust features panel transparency. The higher the value, the more transparent the features panel.
- System supports maximum 4 features. System has checked four features by default. To select other features, cancel the selected features, and then select the ones you need.
- Click to display the features panel on the **LIVE** page, including face detection panel, stranger panel and face DB panel.

Figure 8-55 Features panel

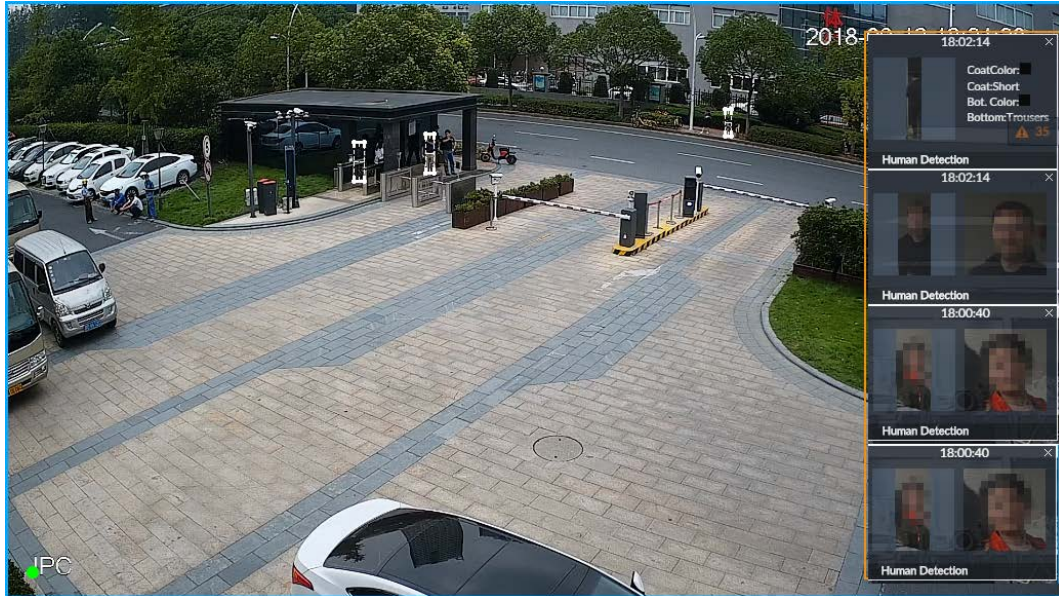

Step 7 Click **Save**.

8.4.2.4.3 Setting Entries Frequency

Step 1 Click , or click  on the configuration page, and then select **EVENT**.

Step 2 Select the root node in the device tree on the left.

Step 3 Select **AI Application > Entries Frequency**.

Figure 8-56 Entries frequency

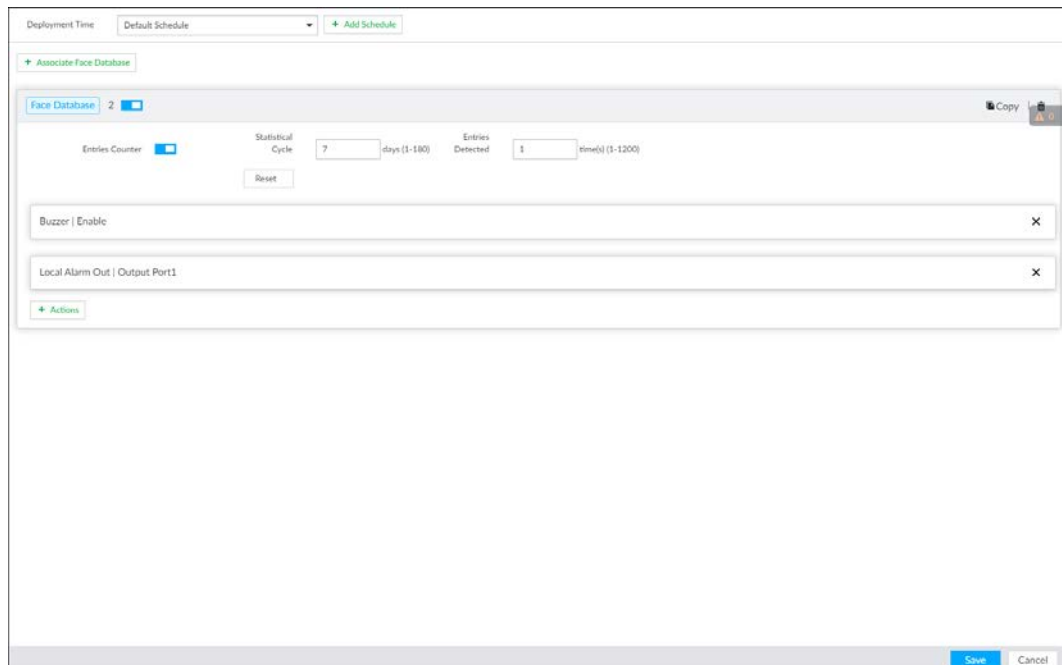

Step 4 Click **Associate Face Database**, and then select the database to be linked.

Step 5 Configure the parameters.

Table 8-20 Entries frequency parameters

Parameter	Description
Entries Counter	Click <input checked="" type="checkbox"/> to enable entries counter. Entries will be counted.

Parameter	Description
Statistical Cycle	<ul style="list-style-type: none"> Set the statistical cycle as needed. The statistical cycle is 7 days by default.
Entries Detected	<ul style="list-style-type: none"> Set the threshold of entries frequency as needed. When the entries detected reaches or exceeds the threshold, an alarm is triggered. The value is 1 by default.
Reset	Clear all entry counts.

Step 6 Click the **Deployment Time** drop-down list to select or add a schedule as needed. After setting the deployment time, only an alarm occurring within the schedule triggers linkage actions.

Step 7 Click **Actions** to set alarm linkage actions.

Step 8 Click **Save**.

After setting entries frequency, when the entries detected of a person reach or exceed the threshold, the features panel on the right side of the view window displays a high frequency tag. You can find the tag using live view or AI search.

- For details about live view, see "6.2.3 Live View of Face Detection".
- For details about face search, see "6.2.4 Face Search".

Figure 8-57 High frequency tag



8.4.2.4.4 Video Diagnosis

The Device can analyze and trigger alarm against blurry image, tampering, color cast and more, and then generate statistics reports.

Configuring Video Diagnosis

After enabling video diagnosis, the Device triggers an alarm when the video quality is affected by blurry image, tampering, color cast and more.

Step 1 Log in to PCAPP.

Step 2 Click  or click  on the configuration page, and then select **EVENT**.

Step 3 Select the root node in the device tree on the left.

Step 4 Select **AI Application > Video Diagnosis**.

Figure 8-58 Video diagnosis

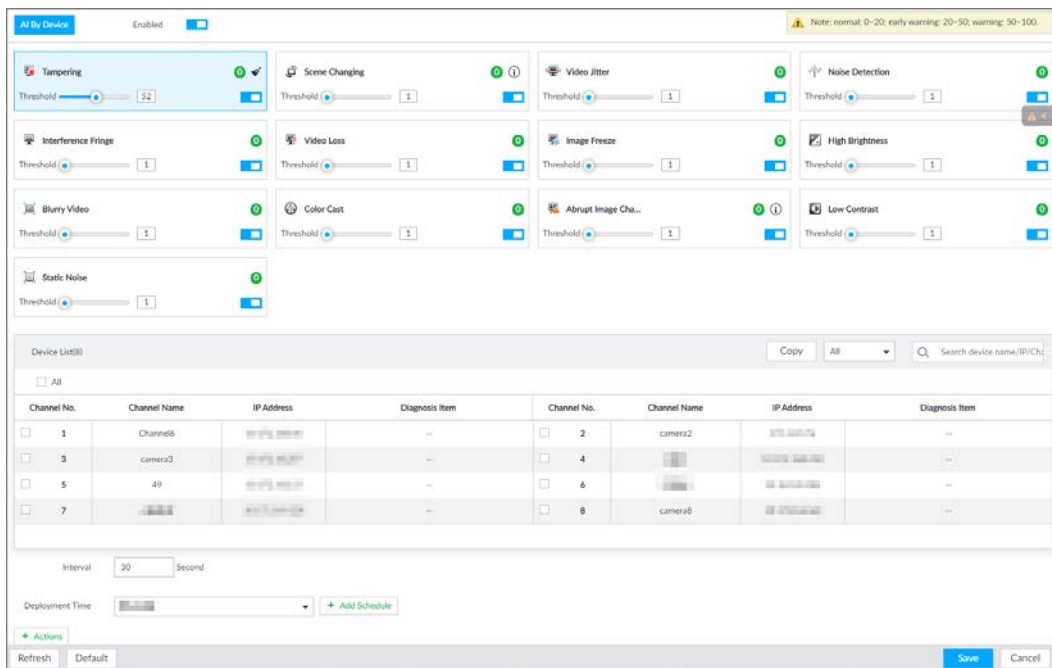

Step 5 Click to enable video quality analysis.

Step 6 Configure the parameters

- 1) Click to enable a type of video quality analysis, for example, tampering.
- 2) Set the threshold.
- 3) On the device list, select one or more devices.
- 4) Set the interval.

Step 7 Click the **Deployment Time** drop-down list to select a schedule.

After setting the deployment time, only an alarm occurring within the schedule triggers linkage actions.



If no schedule is added or the added schedule does not meet actual needs, click **Add Schedule**.

Step 8 Click **Actions** to set alarm linkage actions.

Step 9 Click **Save**.

Viewing AI Report

You can view the daily, monthly, or yearly video diagnosis statistics report of specific devices.

Step 1 On the **Live** page, click **+**, and then select **AI Report > Video Diagnosis**.

Step 2 Select a device and diagnosis type.

Step 3 Select **Daily**, **Monthly**, **Yearly** and then set a specific date, month or year.

Step 4 Click **OK**.

The diagnosis statistics are displayed in a statistical chart. You can view the channel name and diagnosis time on the list below the chart.



- Click to display the statistics in a bar chart.
- Click to display the statistics in a pie chart.

Figure 8-59 AI report

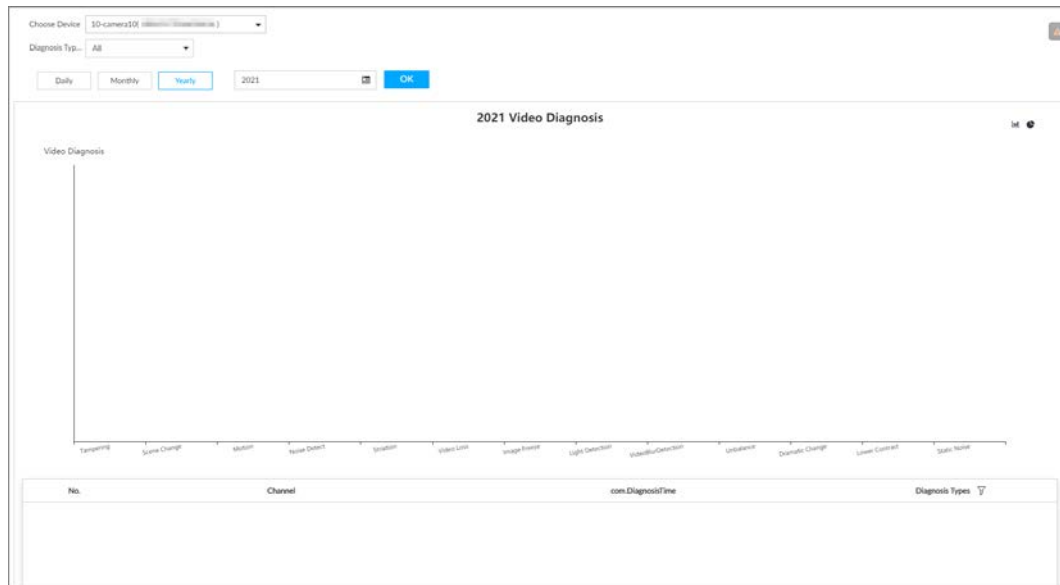

8.4.2.5 Configuring Device Alarm

Set device alarm. When alarm input device sends an alarm signal to the Device, an alarm is triggered.



- Make sure that the Device is connected with alarm input device.
- The Device supports 16-channel alarm input. Configure according to actual port of alarm input device. Take ALARM1 port connection for example.

Step 1 Click or click on the configuration page, and then select **EVENT**.

Step 2 Select the root node in the device tree on the left.

Step 3 Select **Device Alarm** > **IO1**.

Figure 8-60 IO1

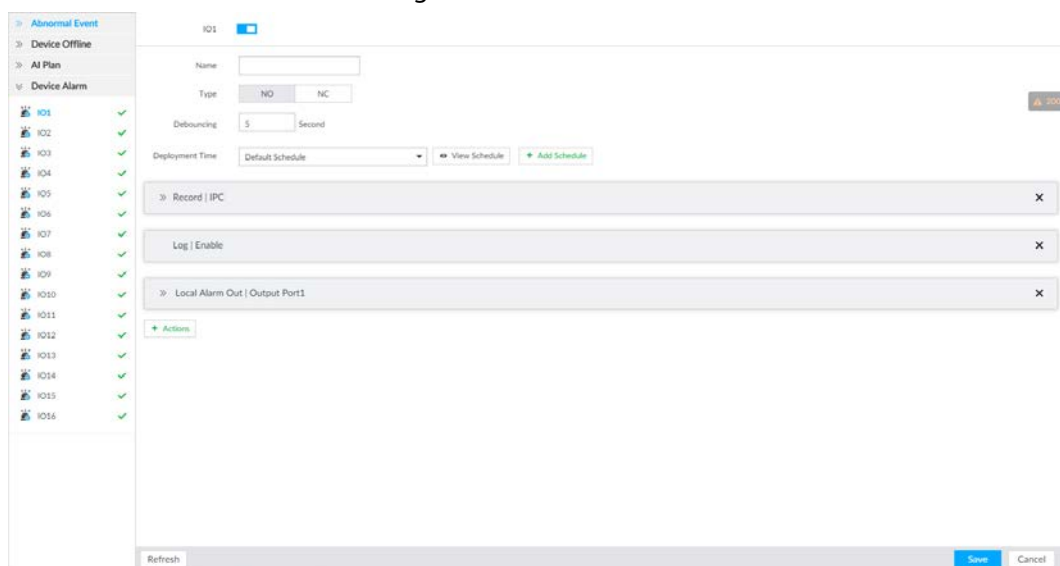

Step 4 Click to enable local alarm.

Step 5 Set parameters.

Table 8-21 Local alarm parameters description

Parameters	Description
Name	In the Alarm name box, enter a name for the alarm.
Type	Select alarm input device type. Both NO and NC are supported.
Debouncing	The system records only one event during this period.

Step 6 Click **Deployment Time** to select schedule from the drop-down list.

After setting deployment period, system triggers corresponding operations when there is a motion detection alarm in the specified period.

- Click **View Schedule** to view detailed schedule settings.
- If the schedule is not added or the added schedule does not meet actual needs, click **Add Schedule**. See "8.8.4 Schedule" for detailed information.

Step 7 Click **Actions** to set alarm actions. See "8.4.1 Alarm Actions" for detailed information.

Step 8 Click **Save**.

8.4.3 Remote Device

Set alarm actions of remote device, including video detection alarm, offline alarm and AI plan of remote device.



The parameters might be different depending on the model you purchased.

8.4.3.1 Video Detection

Video detection function adopts the PC visual, image and graphical processing technology to analyze the video image and check there is considerable changes on the video. Once there are considerable video changes (such as there is any moving object, or the video is blurred), system triggers corresponding alarm event.

8.4.3.1.1 Configuring Video Motion

After analyzing video, system can generate a video motion alarm when the detected moving target reaches the sensitivity you set here.

Step 1 Click , or click  on the configuration page, and then select **EVENT**.

Step 2 Select remote device in the device tree on the left.

Step 3 Select **Video Detect > Video Motion**.

Figure 8-61 Video motion

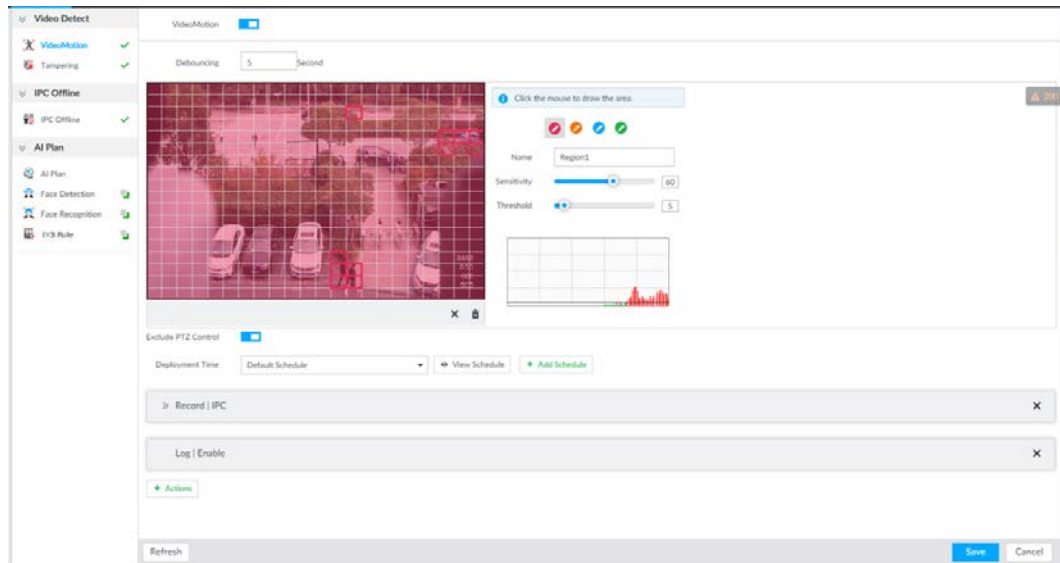

Step 4 Click to enable video motion detection.

Step 5 Set parameters.

Table 8-22 Motion detect parameters description

Parameters	Description
Debouncing	System only records one alarm event during the debouncing period.
Exclude PTZ control	After enabling exclude PTZ control, system does not trigger an alarm when you are manually control the PTZ. It is for PTZ camera only.

Step 6 Set motion detection region.

System supports maximum four detection zones. After setting, once there is an alarm from any of these four zones, the remote device triggers an alarm.

- 1) Click motion detection zone icon .
- 2) On the surveillance video, press and hold on the left button of mouse to select detection zone.
 - Select the motion detect zone you have drawn. Click to delete the zone.
 - Click to clear the zone you have drawn.
- 3) Set parameters.

Table 8-23 Description of zone parameters

Parameters	Description
Name	Set detection zone name to distinguish different zones.
Sensitivity	Drag to set sensitivity. The higher the sensitivity is, the easier it is to trigger an alarm. At the same time, the false alarm rate increases as well. Usually we recommend the default value.

Parameters	Description
Threshold	Drag  to adjust threshold. Once the detected percentage (the percentage of target to detection zone) is equivalent to or larger than the specified threshold, system triggers alarm. For example, the threshold is 10. Once the detected target occupies the 10% of the detection zone, system triggers an alarm.

- Step 7** Click **Deployment Time** to select schedule from the drop-down list.
 After setting deployment period, system triggers corresponding operations when there is a motion detection alarm in the specified period.
- Click **View Schedule** to view detailed schedule settings.
 - If the schedule is not added or the added schedule does not meet actual needs, click **Add Schedule**. See "8.8.4 Schedule" for detailed information.
- Step 8** Click **Actions** to set alarm actions. See "8.4.1 Alarm Actions" for detailed information.
- Step 9** Click **Save**.

8.4.3.1.2 Tampering

Once something tampers the surveillance video, and the output video is in one color, the system can generate an alarm.



- Step 1** Click  or click  on the configuration page, and then select **EVENT**.
- Step 2** Select remote device in the device tree on the left.
- Step 3** Select **Video Detect > Tampering**.

Figure 8-62 Tampering



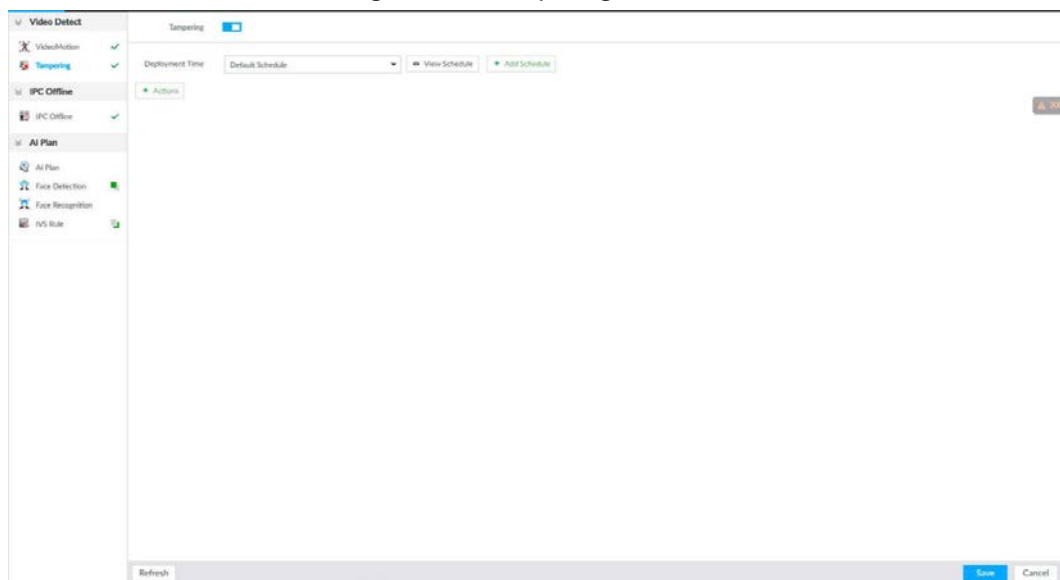

- Step 4** Click to enable tampering alarm.
- Step 5** Click **Deployment Time** to select schedule from the drop-down list.
 After setting deployment period, system triggers corresponding operations when there is a motion detection alarm in the specified period.
- Click **View Schedule** to view detailed schedule settings.
 - If the schedule is not added or the added schedule does not meet actual needs, click **Add Schedule**. See "8.8.4 Schedule" for detailed information.
- Step 6** Click **Actions** to set alarm actions. See "8.4.1 Alarm Actions" for detailed information.

Step 7 Click **Save**.

8.4.3.2 Offline Alarm

When the remote device and the IVSS are disconnected, system can trigger an alarm.

Step 1 Click  or click  on the configuration page, and then select **EVENT**.

Step 2 Select a remote device in the device tree on the left.

Step 3 Select **Device Offline** > **Device Offline**.

Figure 8-63 IPC offline

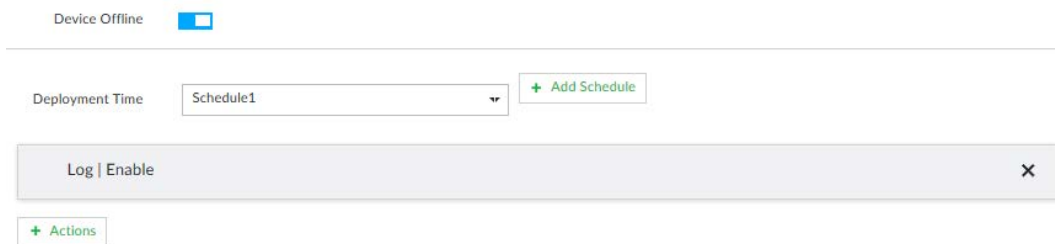

Step 4 Click  to enable offline alarm.



The device offline alarm is enabled by default. You can skip this step.

Step 5 Click **Deployment Time** to select schedule from the drop-down list.

After setting deployment period, system triggers corresponding operations when there is a device offline alarm in the specified period.

- Click **View Schedule** to view detailed schedule settings.
- If the schedule is not added or the added schedule does not meet actual needs, click **Add Schedule**. See "8.8.4 Schedule" for detailed information.

Step 6 Click **Actions** to set alarm actions. See "8.4.1 Alarm Actions" for detailed information.

Step 7 Click **Save**.

8.4.3.3 IPC External Alarm

Set IPC alarm input event, so that when there is an alarm input to the IPC, IPC uploads the alarm to the Device. If the camera has multiple IO channels, you can set the alarm input event for each of them as you might need.

Step 1 Click  or click  on the configuration page, and then select **EVENT**.

Step 2 Select a remote device in the device tree on the left.

Step 3 Select **External Alarm** > **IO1**.

Figure 8-64 IO1

IO1

Name

Type NO NC

Debouncing Second (0-600)

Deployment Time

Step 4 Click to enable the alarm.

Step 5 Set parameters.

Table 8-24 Local alarm parameters description

Parameters	Description
Name	In the Alarm name box, enter a name for the alarm.
Type	Select alarm input device type. Both NO and NC are supported.
Debouncing	The system records only one event during this period.

Step 6 Click **Deployment Time** to select schedule from the drop-down list.

After setting deployment period, system triggers corresponding operations when there is a motion detection alarm in the specified period.

- Click **View Schedule** to view detailed schedule settings.
- If the schedule is not added or the added schedule does not meet actual needs, click **Add Schedule**. See "8.8.4 Schedule" for detailed information.

Step 7 Click **Actions** to set alarm actions. See "8.4.1 Alarm Actions" for detailed information.

Step 8 Click **Save**.

8.4.3.4 Thermal Alarm



- Alarm types vary depending on the models of thermal cameras.
- Make sure that configurations of thermal detections such as fire detection and temperature detection have been done on the thermal camera.

Support the following thermal camera alarms.

Table 8-25 Thermal alarms

Function	Description
Fire alarm	When the thermal camera detects a fire, the alarm signal is transmitted to the Device, which performs an alarm linkage action.
Temperature alarm	When the thermal camera detects that the temperature is above or below the threshold value, the alarm signal is transmitted to the Device, which performs an alarm linkage action.
Temperature difference alarm	When the thermal camera detects a temperature difference greater than the set value, the alarm signal is transmitted to the Device, and the Device will perform an alarm linkage action.
Hot spot alarm	When the maximum temperature detected by the thermal camera is higher than the set value, the alarm signal is transmitted to the Device, and the Device will perform an alarm linkage action.
Cold spot alarm	When the lowest temperature detected by the thermal camera is below the set value, the alarm signal is transmitted to the Device, and the Device will perform an alarm linkage action.

This section uses the procedure of configuring fire alarm as an example.

Step 1 Click or click on the configuration page, and then select **EVENT**.

Step 2 Select the root node in the device tree on the left.

Step 3 Select **Thermal Alarm > Fire Alarm**.

Step 4 Click **Deployment Time** to select schedule from the drop-down list.

After setting deployment period, system triggers corresponding operations when there is a motion detection alarm in the specified period.

- Click **View Schedule** to view detailed schedule settings.
- If the schedule is not added or the added schedule does not meet actual needs, click **Add Schedule**. See "8.8.4 Schedule" for detailed information.

Step 5 Click **Actions** to set alarm actions. See "8.4.1 Alarm Actions" for detailed information.

Step 6 Click **Save**.

8.5 Storage Management

Click or click on the configuration page, select **STORAGE**. The **Local Hard Disk** page is displayed. Manage storage resources (such as recording file) and space, so you can use and improve utilization ratio of storage space.



The system supports pre-check and routine inspection, and displays health status, so you can obtain real-time status of device and avoid data loss.

- **Pre-check:** During device operation, the system automatically detects disk status in case of change (reboot, insert and pull the disk).
- **Routine inspection:** the system carries out routine inspection of the disk continuously. During device operation, the disk might go wrong due to service life, environment and other factors. Find out any problems during routine inspection.

8.5.1 Storage Resource

8.5.1.1 Local Hard Disk

The local hard disk refers to the HDD installed on the system. You can view HDD space (free space/total space), temperature (centigrade/Fahrenheit), HDD information and so on.

Click or click on the configuration page, and then select **STORAGE > Storage Resource > Local Hard Disk**. There is a corresponding icon near the HDD name after you create the RAID and hot spare HDD.

- : RAID HDD.
- : Global hot spare HDD.
- : Invalid HDD of RAID group.



Slight difference might be found on the user interface.

Figure 8-65 HDD

OR	Name	Drive Letter	Model	Free Space/Total	HDD Type	BUS Type	Used Type	State	Sn	Power Status
<input type="checkbox"/>	HDD1	/dev/sda		3.41TB/3.63TB	DISK	SAS	Data	Normal		Idle
<input type="checkbox"/>	HDD2	/dev/sdb		3.63TB/3.63TB	DISK	SATA	Data	Normal		Hibernute
<input type="checkbox"/>	HDD3	/dev/sdc		5.45TB/5.45TB	DISK	SATA	Data	Normal		Hibernute
<input type="checkbox"/>	HDD11	/dev/sdd		1.88TB/3.63TB	DISK	SATA	Data	Normal		In Use

8.5.1.1.1 Viewing S.M.A.R.T

S.M.A.R.T is Self-Monitoring Analysis and Reporting Technology. It is a technical standard to check HDD drive status and report potential problems. System monitors the HDD running status and compares with the specified safety value. Once the monitor status is higher than the specified value, system displays alarm information to guarantee HDD data security.



Check one HDD to view S.M.A.R.T information at one time.

On the **Local Hard Disk** page, select a HDD, and then click **S.M.A.R.T**. The **S.M.A.R.T** page is displayed. Check whether the HDD status is **OK** or not. If there is any problem, fix it in time.

Figure 8-66 S.M.A.R.T

S/n	Note	Value	Worst	Boundary	Original Data	State
1	Read Error Rate	117	99	6	135185072	Better
3	Spin Up Time	97	97	0	0	Better
4	Start/Stop Co...	100	100	20	780	Better
5	Reallocated S...	100	100	36	0	Better
7	Seek Error Rate	67	60	30	17203264542	Better
9	Power On Ho...	98	98	0	2426	Better
10	Spin-up Retry...	100	100	97	0	Better
12	Power On/Of...	100	100	20	752	Better
184	End-to-End F...	100	100	99	0	Better

8.5.1.1.2 Format



- Formatting HDD will clear all data on the HDD. Be careful!
- Hot spare HDD cannot be formatted.

Enter the **Local Hard Disk** page, select HDD, and click **Format**. It is to format the selected HDD.

8.5.1.1.3 File System Repair

Once you cannot mount the HDD or you cannot properly use the HDD, you can try to use the **File System Repair** function to fix the problem.

Enter the **Local Hard Disk** page, select one or more HDD(s) you cannot mount, and click **File System Repair**, you can repair the selected file system of the corresponding HDD(s). The repaired HDD can work properly or to be mounted.

8.5.1.2 RAID

RAID (Redundant Array of Independent Disks) is a data storage virtualization technology that combines multiple physical HDD components into a single logical unit for the purposes of data redundancy, performance improvement, or both.



- The Device supports RAID0, RAID1, RAID5, RAID6, RAID10, RAID50 and RAID60. See "Appendix 3 RAID" for detailed information.
- You are recommended to use enterprise HDD when you are creating RAID, and use surveillance

HDD for single-HDD mode.

8.5.1.2.1 Creating RAID

RAID has different levels such as RAID5, RAID6 and so on. Different RAID levels have different data protection, data availability and performance levels. Create RAID according to your actual requirements.



Creating RAID operation is going to clear all data on these HDD. Be careful!

Procedure

Step 1 Click or click on the configuration page, and then select **STORAGE > Storage Resource > RAID > RAID**.

Figure 8-67 RAID (1)

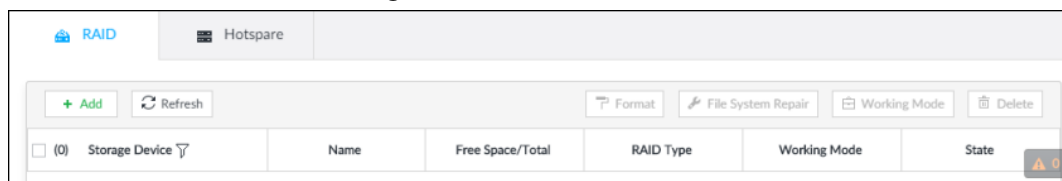

Step 2 Click **Add**.

Figure 8-68 Create RAID (1)

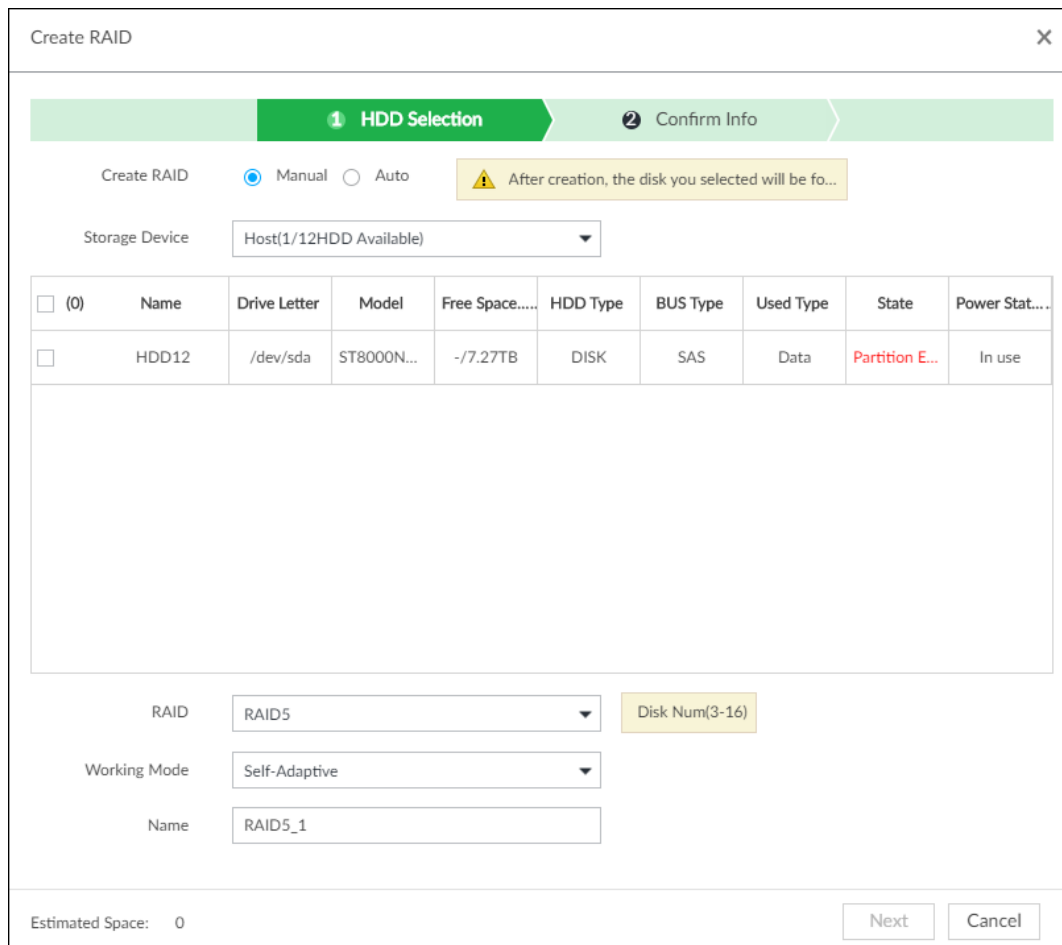

Step 3 Set RAID parameters.
Select RAID creation type according to actual situation. It includes **Manual RAID** and **Auto**

RAID.

- **Manual RAID:** System creates a specified RAID type according to the selected HDD amount.
- 1) Select **Manual RAID**.
 - 2) Select HDD you want to use.
 - 3) Set parameters.

Table 8-26 Manual creation parameters description

Parameters	Description
Storage Device	Select storage device of the HDD and select the HDD you want to add to the RAID.  Different RAID types need different HDD amounts.
RAID	Select a RAID type you want to create.
Working mode	Set RAID resources allocation mode. The default setup is self-adaptive. <ul style="list-style-type: none"> • Self-adaptive means the system can automatically adjust RAID synchronization speed according to current business load. When there is no external business, the synchronization speed is at high speed. When there is external business, the synchronization speed is at low speed. • Sync first: Allocate resources to RAID synchronization first. • Business first: Allocate resources to business first. • Load-Balance: Allocate resources to business and RAID synchronization equally.
Name	Set RAID name.

- **Auto:** System creates RAID5 according to the HDD amount.
- 1) Select **Auto**.

Figure 8-69 Create RAID (2)

Create RAID
✕

1 HDD Selection
2 Confirm Info

Create RAID Manual Auto

⚠ After creation, the disk you selected will be fo...

Storage Device: Host(1/12HDD Available)

Name	Drive Letter	Model	Free Space.....	HDD Type	BUS Type	Used Type	State	Power Stat...
HDD12	/dev/sda	ST8000N...	-/7.27TB	DISK	SAS	Data	Partition E...	In use

RAID: RAID5

HDD number is 1<5, it cannot be created automatically

Working Mode: Self-Adaptive

Estimated Space: 0

Next
Cancel

2) Set parameters.

Table 8-27 Auto parameters description

Parameters	Description
Storage Device	Select storage device of the HDD.
Working Mode	Set RAID resources allocation mode. The default setup is self-adaptive. <ul style="list-style-type: none"> Self-adaptive means the system can automatically adjust RAID synchronization speed according to current business load. When there is no external business, the synchronization speed is at high speed. When there is external business, the synchronization speed is at low speed. Sync first: Allocate resources to RAID synchronization first. Business first: Allocate resources to business first. Load-Balance: Allocate resources to business and RAID synchronization equally.

Step 4 Click **Next**.

Figure 8-70 Confirm info (manual)

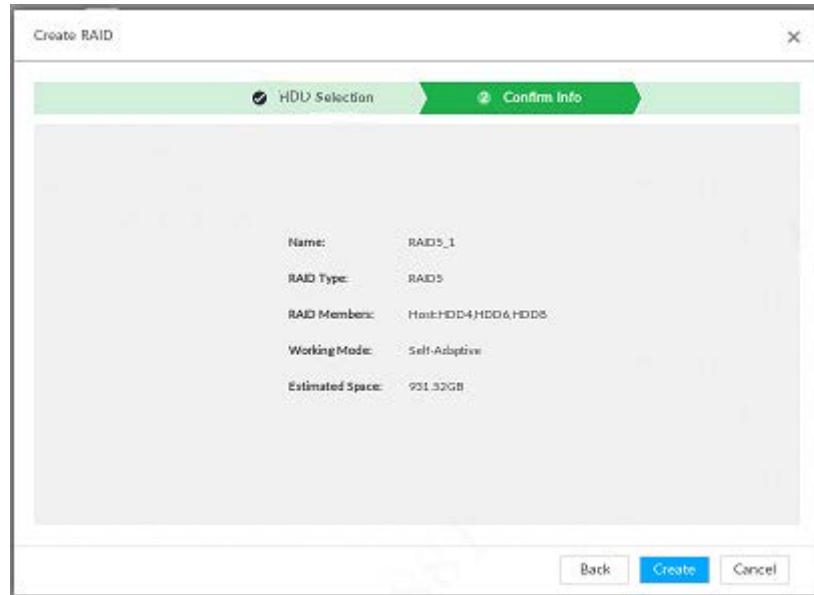
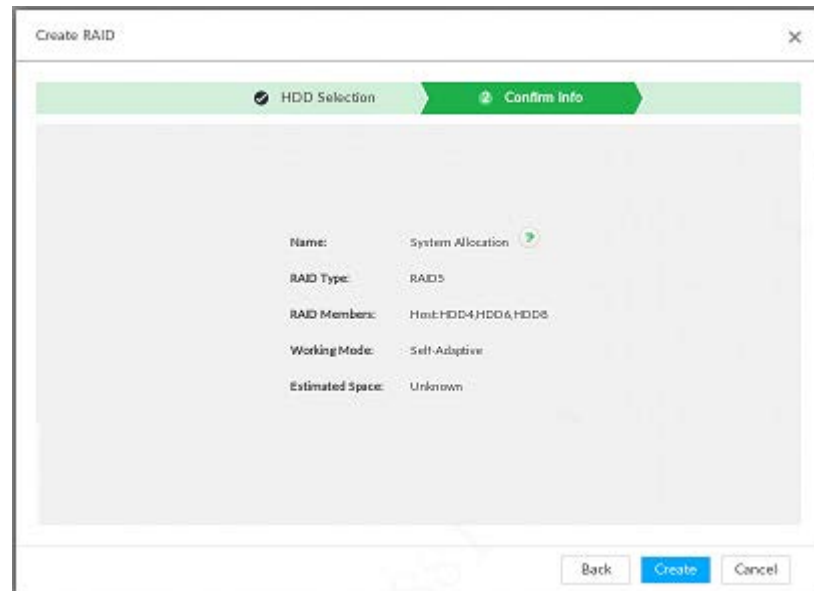

Figure 8-71 Confirm info (Auto)



Step 5 Confirm information.



If the input information is wrong, click **Back** to set RAID parameters again.

Step 6 Click **Create**.

System begins to create RAID. It displays RAID information after creation.

Figure 8-72 RAID (2)

ID	Storage Device	Name	Space	RAID Type	Working Mode	State
1	HDD	RAID5_1	~931.32GB	RAID5	Self-Adaptive	Active/Degraded/Recovering

Related Operations

After creating RAID, view RAID disk status and details, clear up RAID, and repair file system.

Table 8-28 RAID operation

Name	Operation
View RAID HDD status	Click at the right side of the RAID name to open the RAID HDD list. It is to view RAID HDD space, status and so on.
View RAID details	Click to view RAID detailed information.
File System Repair	Once you cannot mount the RAID or you cannot properly use the RAID, you can try to use repair file system function to fix. Enter RAID page, select one or more RAID(s) you cannot mount, click File System Repair , you can repair the selected file system of the corresponding RAID(s). The repaired RAID can work properly or to be mounted.
Modify Working Mode	Select one or more RAID(s), and then click Working Mode to modify the working mode.
Format RAID	Enter RAID page, select one and more RAID groups. Click Format to format the selected RAID. Formatting RAID is to clear all data on the RAID and cancel the RAID group. Please be careful.
Delete RAID	Enter RAID page, select one and more RAID groups. Click Delete to delete the selected RAID. Deleting RAID is to clear all data on the RAID and cancel the RAID group. Please be careful.

8.5.1.2.2 Creating Hot Spare HDD

When a HDD of the RAID group is malfunctioning or has a problem, the hot spare HDD can replace the malfunctioning HDD. There is no risk of data loss and it can guarantee storage system reliability.

Step 1 Click or click on the configuration page, and then select **STORAGE > RAID > Hot spare**.

Figure 8-73 Hot spare (1)



Step 2 Click **Add**.

Figure 8-74 Global hot spare

Add Hotspare X

HDD Selection
Confirm Info

Creation Type: Global Hotspare Private Hotspare

Storage Device: Host03/8HDD Available1

<input type="checkbox"/>	ID	Name	Drive Letter	Model	Space	HDD Type	BUS Type	Used Type	State
<input type="checkbox"/>		HDD4	/dev/sdd	WDCWD10...	990.98GB/9...	DISK	SATA	Data	Running
<input type="checkbox"/>		HDD6	/dev/sdb	ST3500312CS	460.51GB/4...	DISK	SATA	Data	Running
<input type="checkbox"/>		HDD8	/dev/sde	WDCWD10...	990.98GB/9...	DISK	SATA	Data	Running

Figure 8-75 Private hot spare

Add Hotspare X

HDD Selection
Confirm Info

Creation Type: Global Hotspare Private Hotspare

Add:

<input type="checkbox"/>	ID	Name	Drive Letter	Model	Space	HDD Type	BUS Type	Used Type	State
<input type="checkbox"/>		HDD4	/dev/sdd	WDCWD10...	990.98GB/9...	DISK	SATA	Data	Running
<input type="checkbox"/>		HDD6	/dev/sdb	ST3500312CS	460.51GB/4...	DISK	SATA	Data	Running
<input type="checkbox"/>		HDD8	/dev/sde	WDCWD10...	990.98GB/9...	DISK	SATA	Data	Running

Step 3 Select hot spare creation type.

- Global hot spare: Create hot spare for all RAID. It is not a hot spare HDD for a specified RAID group.
- Private hot spare: Select **Private Hot spare** and **Add** it to a RAID group. The private hot spare HDD is for a specified RAID group.

Step 4 Select one or more HDD(s) and then click **Next**.

Figure 8-76 Confirm info

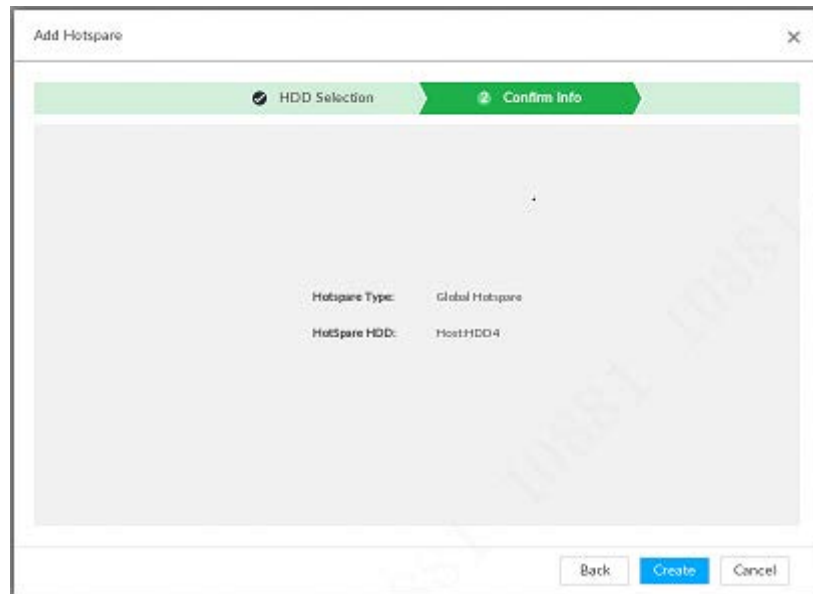

Step 5 Confirm information.



Click **Back** to select hot spare HDD(s) again if you want to change settings.

Step 6 Click **Create** to save settings.

System displays the added hot spare HDD information.

Figure 8-77 Hot spare (2)



Select a hot spare HDD and then click **Delete**, it is to delete hot spare HDD.

8.5.1.3 Network Hard Disk

Network hard disk is a network-based online storage service that stores device information in the network hard disk through the iSCSI protocol.

8.5.1.3.1 iSCSI Application

View network hard disk usage, including remaining capacity, and hard disk status.

Click or click on the configuration page, and then select **STORAGE > Storage Resource > Network Hard Disk > iSCSI Application**.

Figure 8-78 iSCSI application

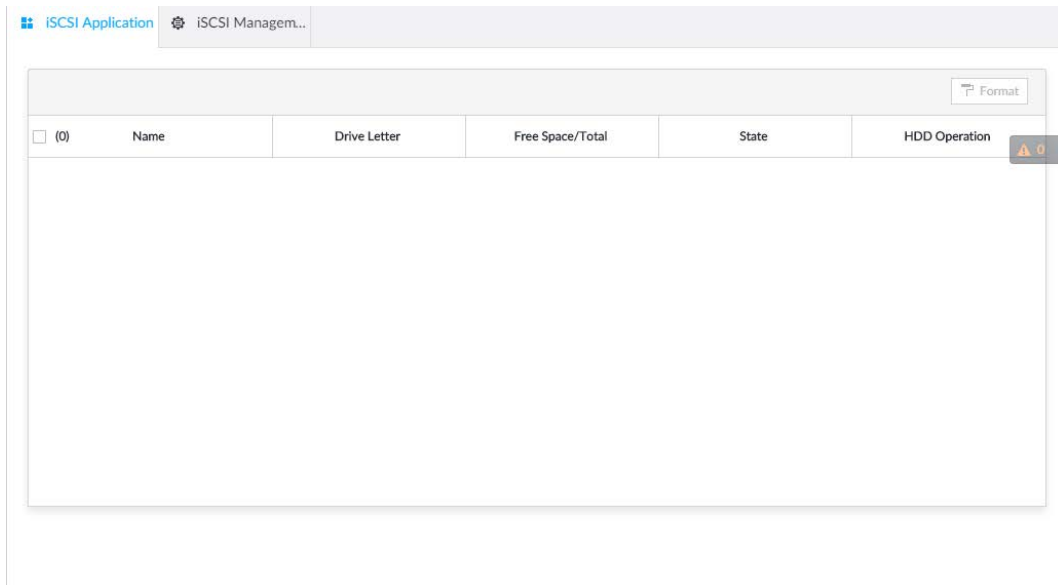

- Select a network hard disk, and then click **Format** to format the disk. Formatting your hard disk will erase all data from your hard disk, so do it carefully.
- Click the **HDD Operation** column, and then you can select an HDD operation permission type.
 - ◇ Read/Write: One can read, edit, add, and delete data of this disk.
 - ◇ Read Only: One can only read data of this disk.

8.5.1.3.2 iSCSI Management

Set up the network disk through iSCSI and map the network disk to the device so that the device can use the network disk for storage.



Make sure that service has been enabled on the iSCSI server and the server has provided the shared file directory.



Step 1 Click , or click  on the configuration page, and then select **STORAGE > Network Hard Disk > iSCSI Management**.

Figure 8-79 Network hard disk



Step 2 Click **+**.

Figure 8-80 Add iSCSI

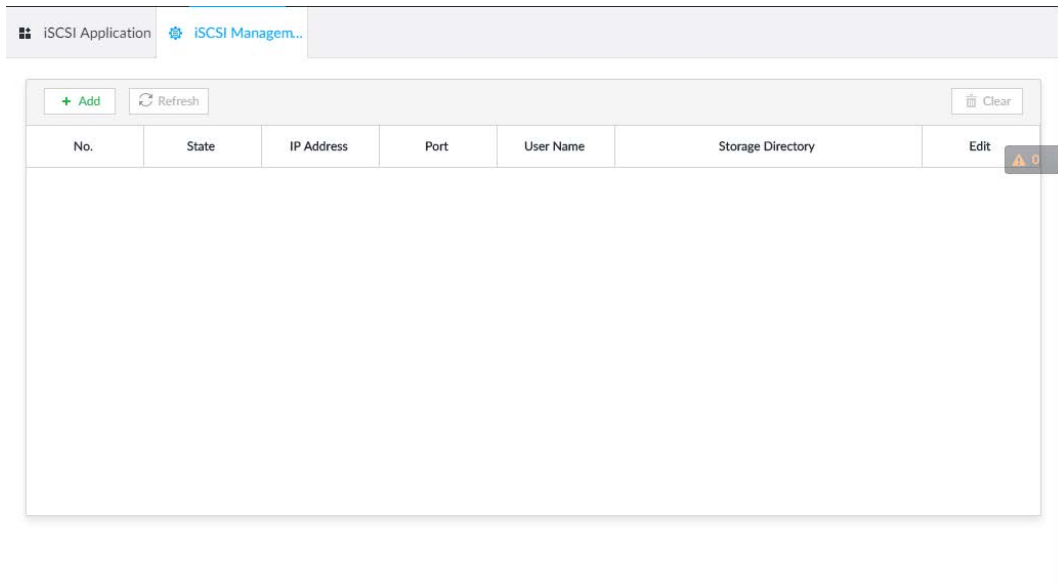
Add
×

Server IP

Port (3260-65535)

Anonymous

User Name

Password



Storage Directory

	No.	Storage Directory
<input type="checkbox"/> (0)		

Step 3 Set parameters.

Table 8-29 Network hard disk parameters

Parameters	Description
Server IP	Enter iSCSI server IP address.
Port	Enter iSCSI server port number. It is 3260 by default.

Parameters	Description
Anonymous	If iSCSI server has no permission limitation, you can select anonymous login. <ul style="list-style-type: none"> •  indicates that anonymous login is enabled and there is no need to set username and password. •  indicates that anonymous login is disabled.
User Name	If access permission has been limited when creating the shared file directory on the iSCSI server, you need to enter username and password.
Password	
Storage Directory	Click Search Directory to select the storage directory.  The storage directory is generated when the shared file directory is being created on the iSCSI server. Each directory is an iSCSI disk.

Step 4 Click **OK**.

The added network disk is displayed.



- Click  to delete a disk; click **Refresh** to refresh the disk list.
- On the **Disk Group** page, you can configure network disk groups. For details, see "8.5.2.1.1 Setting Disk Group".

8.5.2 Video Recording

8.5.2.1 Storage Mode

Allocate disks or RAID groups to different disk groups, and store video and image to specified disk group.





8.5.2.1.1 Setting Disk Group

Disk and created RAID group are allocated to group 1 by default. You can allocate disk and RAID group to other groups according to your actual needs.

The default number of disk group is the same as the maximum number of HDD that IVSS supports. For example, the Device supports a maximum number of 16 HDDs, and then the default number of disk group is 16.

Step 1 Click , or click  on the configuration page, and then select **STORAGE > VIDEO RECORDING > Storage Mode > Disk Group**.



- The value (such as ) next to the group name refers to the number of HDD and RAID group in the disk group. If instead,  is displayed, it means no available HDD or RAID group in the disk group, but there is video or image stored in the disk group.
-  indicates picture storage.  indicates video storage

Step 2 Click a disk group.

Figure 8-81 Disk group

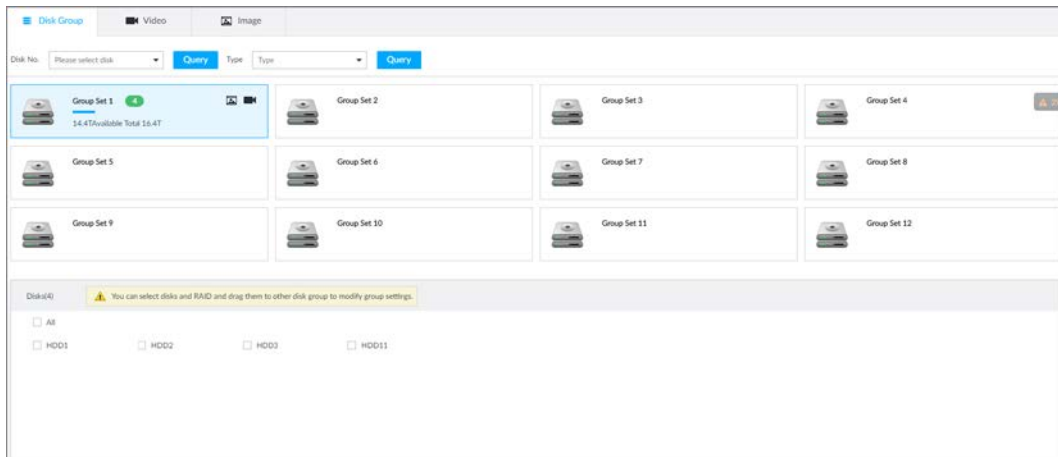

Step 3 Select HDD or RAID group from **Disks**, and then drag the HDD or the RAID group to another disk group.

Disk grouping takes effect immediately.



Select **All** to select all the HDDs and RAID groups of the disk group.

After configuring disk groups, you can also view which disk group the selected disk, video or picture belongs to.

Table 8-30 Disk group functions

Function	Description
View the disk group of a disk, video or picture	Click <input type="text" value="Disk No. Please select disk"/> , select a disk or RAID group, and then click Query to search for the disk group that the selected disk or RAID group belongs to.
View disk groups of video or image	Select Video or Image from <input type="text" value="Type Type"/> , and then click Query to search for disk groups of the selected type.

8.5.2.1.2 Setting Video/Image Storage

Videos/images of all channels are stored in disk group 1 by default. You can store the videos/images in different disk groups according to actual needs. Two methods are available to set video/image storage.



This section uses storing video for example. To store images, the procedure is similar.

Method 1: Selecting Disk Group

Step 1 Click or click on the configuration page, and then select **STORAGE > VIDEO RECORDING > Storage Mode > Video**.

Figure 8-82 Video

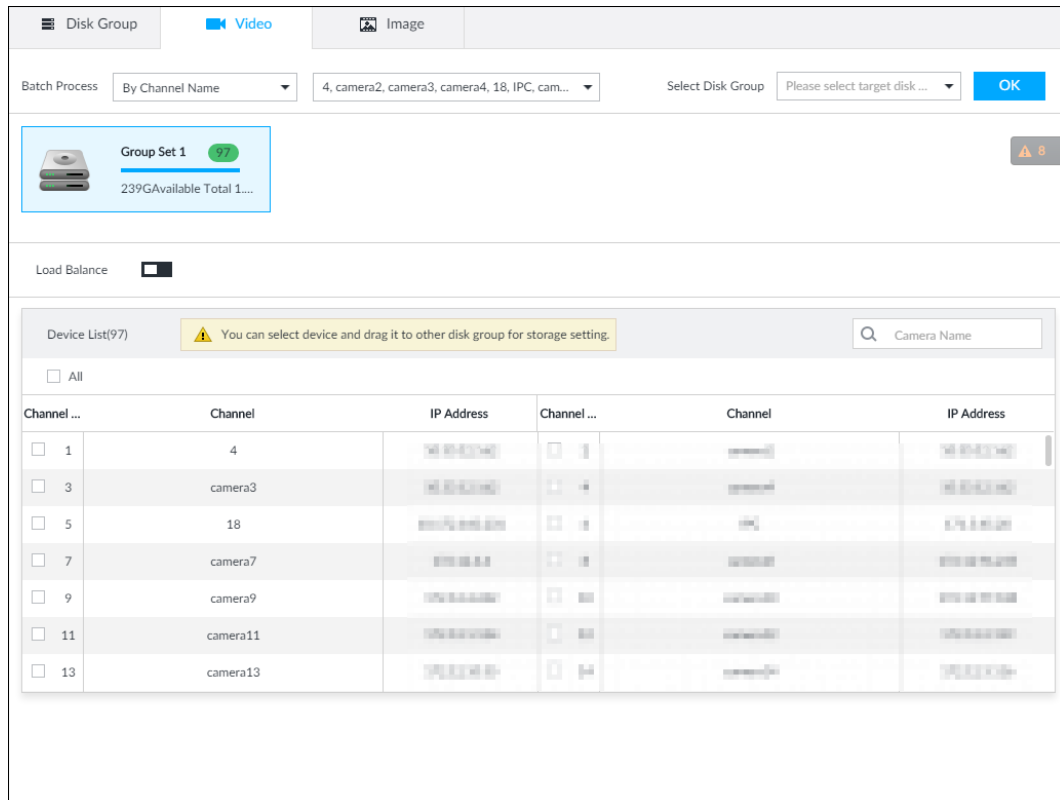

- Step 2** Select filtering way from the **Batch Process** drop-down list.
- By Channel Name: Select channel according to the channel name.
 - By Logical Channel No.: Select channel that is connected to the Device. In this case, **Start Channel No.** and **End Channel No.** need to be configured.

- Step 3** In the **Select Disk Group** drop-down list, select target disk group.



In the drop-down list, only disk group with available HDD or RAID group is displayed.

- Step 4** Click **OK**.

- Step 5** Disk grouping takes effect immediately.

Method 2: Dragging Channel

- Step 1** Click or click on the configuration page, and then select **VIDEO RECORDING > Storage Mode > Video**.

- Step 2** Click a disk group.

The linked channels of the disk group are displayed in **Device List**.



- Only disk group with available HDD or RAID group or linked channel is displayed.
- The value (such as) next to the group name refers to the number of HDD and RAID group in the disk group. If instead, is displayed, it means no available HDD or RAID group in the disk group, but there is video or image stored in the disk group.

Figure 8-83 Device list

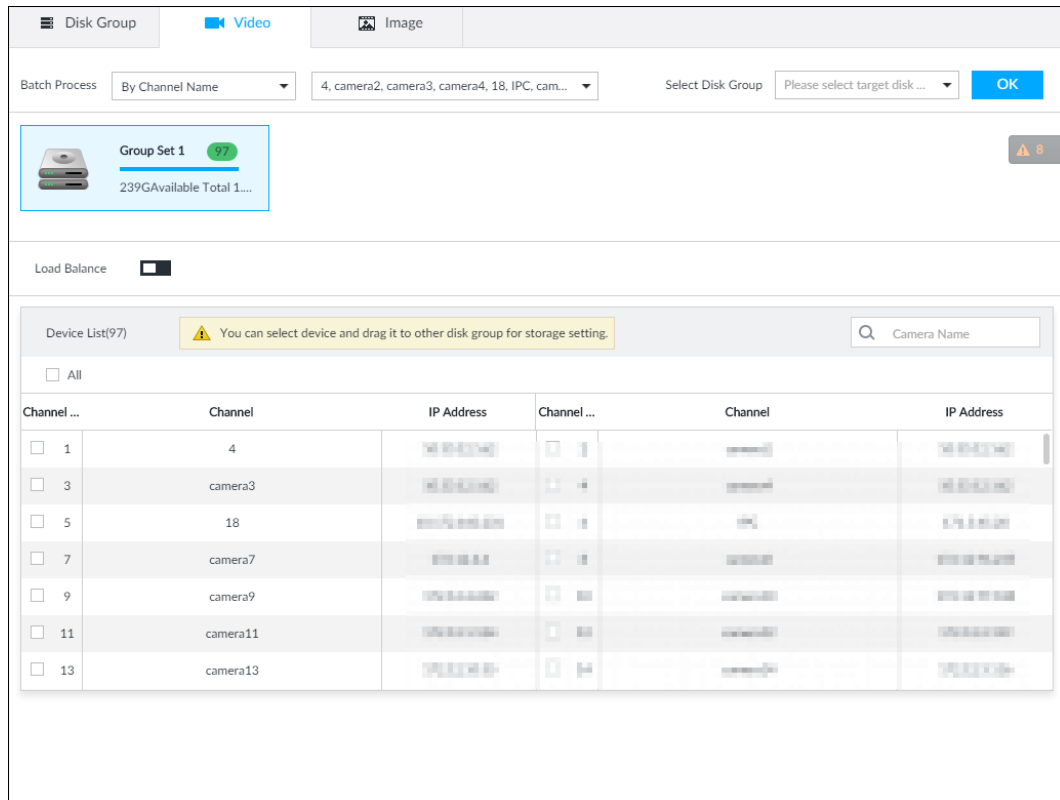

Step 3 (Optional) Click to enable load balance, and then the icon turns into blue. To disable it, click it again, and then the icon turns into gray.

- After load balance is enabled, if one disk group has no usable disk, the video of all channels that belong to this disk group will be stored into all the usable disk groups.
- When load balance is not enabled, if one disk group has no usable disk, the video of all channels that belong to this disk group will be stored in another usable disk group.

Step 4 Select a channel from the device list, and drag the channel to the target disk group.

Step 5 Disk grouping takes effect immediately.

8.5.2.2 Recording Schedule

Configure recording modes and schedules for channels.

8.5.2.2.1 Recording Mode

Configure recording modes for channels.

Step 1 Click or click on the configuration page, and then select **STORAGE > VIDEO RECORDING > Schedule**.

Step 2 Find the camera for which you want to configure a recording schedule, select the recording methods for the stream types.

- means that the type is selected.
- **Substream1** and **Substream2** cannot be enabled at the same time.
- **Auto**: Records automatically according to the schedule.
- **Manual**: Records around the clock and does not respond to the recording schedule.
- **Close**: No recording and does not respond to the recording schedule.

- Step 3** Select a recording method.
- Step 4** (Optional) click to disabled the recording schedule configuration of the selected channel
- Step 5** Click **Save**.

Figure 8-84 Recording Mode

DEVICE INFO		Record Mode								
		Main Stream			Substream1			Substream2		
Channel No	Channel	<input checked="" type="radio"/> Auto	<input type="radio"/> Man...	<input type="radio"/> Close	<input type="radio"/> Auto	<input type="radio"/> Man...	<input type="radio"/> Close	<input type="radio"/> Auto	<input type="radio"/> Man...	<input checked="" type="radio"/> Close
1	camera1	<input checked="" type="radio"/>	<input type="radio"/>	<input type="radio"/>	<input type="radio"/>	<input checked="" type="radio"/>	<input type="radio"/>	<input type="radio"/>	<input type="radio"/>	<input checked="" type="radio"/>
2	camera2	<input checked="" type="radio"/>	<input type="radio"/>	<input type="radio"/>	<input type="radio"/>	<input type="radio"/>	<input checked="" type="radio"/>	<input type="radio"/>	<input type="radio"/>	<input checked="" type="radio"/>

8.5.2.2.2 Recording Schedule

Configure video and picture recording schedules so the Device records and captures pictures as configured in the specified period.

- Step 1** Click or click on the configuration page, and then select **STORAGE > VIDEO RECORDING > Schedule**.
- Step 2** Click , and then set a recording schedule.

Figure 8-85 Set a recording schedule

Setting

Channel No 1

General Default Schedule + Add Schedule

Record Events Pre-Record Second (0-30)

ANR Min (1-10080)

Record Stream Main Stream Substream1 Substream2

Instant Record Duration Min (1-30)

Manual Snap Image(s) (1-5) Interval Second

Event Snap Interval Second (1-3600)

Copy to

1. Set **General** recoding schedule.
2. Select the **General** checkbox to enable the function.
3. Click **Add Schedule**.
4. Click , name the schedule, select a type and then click **OK**.
5. Specify recording hours by dragging the sliders on the day bars.
 - Always Effective: Records according to the schedule.
 - Customize: Select this option, click to define the validity periods of the schedule.

Figure 8-86 Add a schedule

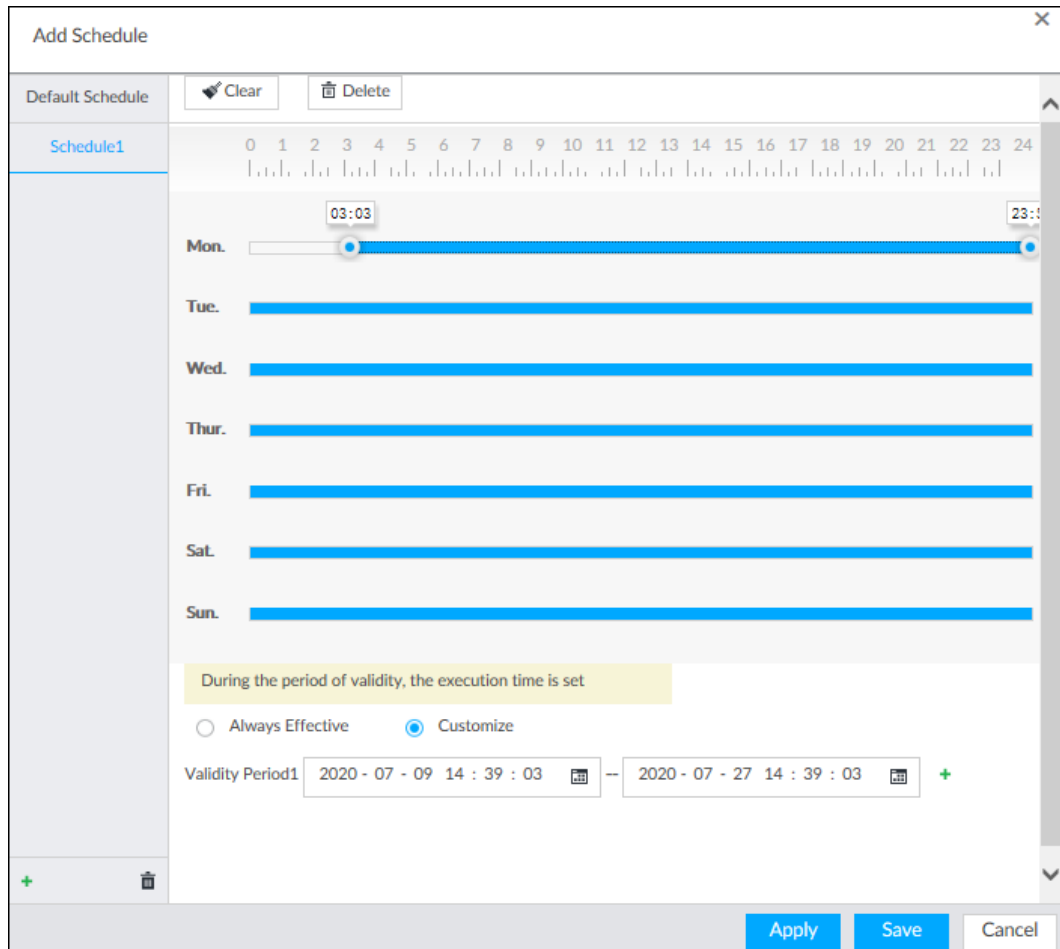

6. Click **Save**.

Step 3 Set other parameters and then click **OK**.

- Record Events: Record event videos.
- Pre-record: The recording duration prior to the event.
- ANR: Automatic Network Replenishment. When ANR is enabled (by clicking), the Device will download videos recorded by IPC and stored on camera SD card during network disconnection. Enter the time length of the video to be downloaded from IPC. The Device will download only the defined length of video even if the disconnection is longer.



Make sure that the IPC has an SD card and is recording.

- Record Stream: Select stream types and recording modes.
- Instant Record Duration: The duration of instant recording. After starting instant recording on the **LIVE** page, if you do not stop recording, it will automatically stops after the defined duration.
- Manual Snap: The number of images for each manual capture action. Enter a value to specify the number of seconds between each image.
- Event Snap: The number of images captured for each event.
- Copy to: Copy the current settings to other channels.



8.5.2.3 Basic

Configure the storage mode when the disk space is used up and the automatic deletion of expired files.

8.5.2.3.1 Setting Storage Mode

Configure the storage mode when there is no more disk space available.

Step 1 Log in to PCAPP.

Step 2 Click , or click  on the configuration page, and then select **STORAGE > VIDEO RECORDING > Storage Mode**.

Step 3 Set storage mode.

- **Overwrite:** When HDD free space is less than 100 GB or 2% of the total space (the larger of the two values prevails), the Device deletes 100 GB of the earliest record files and continues to record.



Data will be overwritten in the **Overwrite** mode. Back up in time.

- **Stop:** When HDD free space is less than the defined free space alarm rate of the total space, an alarm is triggered and the Device continues recording until HDD free space is used up.

Figure 8-87 Storage mode

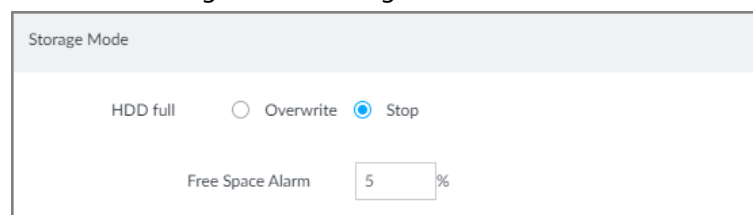



Step 4 Click **Save**.

8.5.2.3.2 Setting Automatic File Deletion

You can enable the Device to automatically delete files older than a certain number of days.

Step 1 Log in to PCAPP.

Step 2 Click , or click  on the configuration page, and then select **STORAGE > VIDEO RECORDING > Storage Mode**.

Step 3 Set automatic file deletion.

- **Never:** The Device does not delete files automatically.
- **Customize:** The Device automatically deletes files older than the configured number of days.



The deleted files cannot be recovered.

Figure 8-88 Delete expired files

Step 4 Click **Save**.

8.5.2.4 Record Transfer

When the device and an IPC are disconnected, the IPC continues to record and stores the recording in the SD card. After the network is recovered, the device will download the recording during the disconnection from the IPC.

Two ways for record transfer after the network recovers.

- Automatic download: After the network recovers, the device automatically downloads the recording in the set time period.
- Manual download: If ANR is not enabled when you set the recording schedule, after the network recovers, the device can not automatically download the recording during the disconnection, but the user can manually create the download task.

Step 1 Click or click on the configuration page, and then select **STORAGE > VIDEO RECORDING > Record Transfer**.

Step 2 Click **Add**.

Figure 8-89 Add

Step 3 Select **By Channel Name** or **By Channel No.** in the **Batch Process** drop-down list.

Step 4 Set time period of the video to be searched.

Step 5 Click **OK**.

The transfer progress is displayed.



Select a transfer task, click **Delete** to delete it. A task in progress cannot be deleted.

8.6 Security Strategy

Click or click on the configuration page, select **SECURITY**. The **SECURITY** page is displayed.

Set security strategy to guarantee device network and data safety. It includes HTTPS, set host IP access rights, enable network security protection.

8.6.1 HTTPS

HTTPS can use the reliable and stable technological means to guarantee user information and device security and communication data security. After installing the certificate, you can use the HTTPS on the PC to access the device.



- HTTPS function is for web interface and PCAPP only.
- You are recommended to enable HTTPS service. Otherwise, you might risk data leakage.

8.6.1.1 Installing Certificate

There are two ways to install the certificate.



- Manually create a certificate and then install.
- Upload a signature certificate and then install.

8.6.1.1.1 Installing the Created Certificate

Install the created certificate manually. It includes creating the certificate on the device, downloading and installing the certificate on the PC.



- Create and install root certificate if it is your first time to use HTTPS or you have changed device IP address.
- After creating server certificate and installing root certificate, download and install root certificate on the new PC, or download the certificate and then copy to the new PC.

Step 1 Click  or click  on the configuration page, and then select **SECURITY > Credential**.

Step 2 Create certificate on the device.

- 1) Click **Create certificate**.
- 2) Set parameters as required.



IP/domain shall be the device IP or the domain.

- 3) Click **OK**.
System begins to install certificate, and then displays certificate information after the installation.

Step 3 Download certificate.

- 1) Click .
- The **Opening ca.crt** page is displayed.
- 2) Click **Save File** to select file saving path.
- 3) Click **Save**.
System begins downloading certificate file.

Step 4 Install root certificate on the PC.

- 1) Double-click the certificate.
System displays **Open file-security warning** page.
- 2) Click **Open**.
- 3) Click **Install Certificate**.

- 4) Follow the prompts to import the certificate.
System goes back to **Certificate** page.

Step 5 Click **OK** to complete certificate installation.

Figure 8-90 Installed certificate

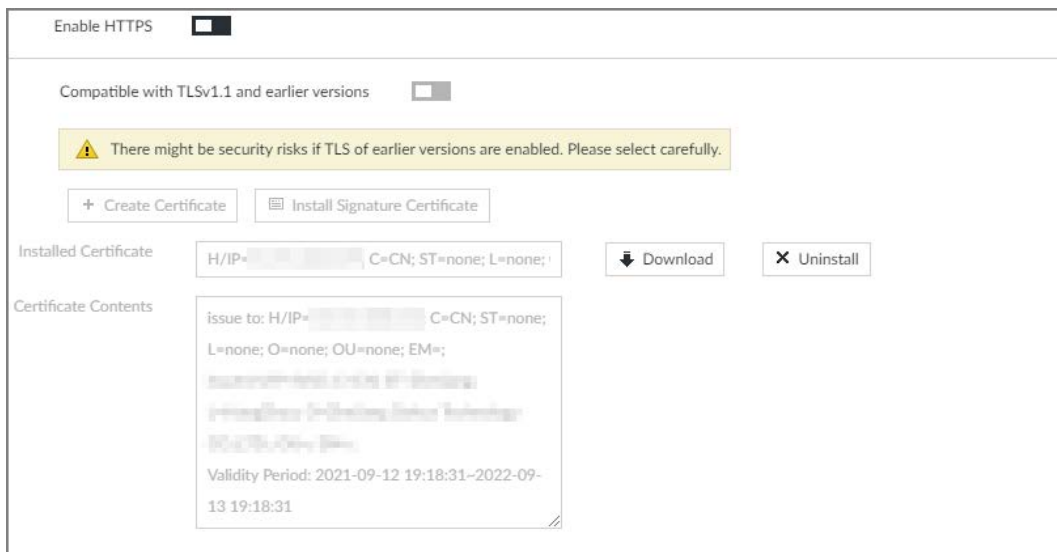

8.6.1.1.2 Installing Signature Certificate

Upload signature certificate to install.

Prerequisites

Before installation, make sure that you have obtained safe and valid signature certificate.

Procedure



- Step 1** Click  or click  on the configuration page, and then select **SECURITY > Credential**.
- Step 2** Click **Install Signature Certificate**.

Figure 8-91 Install signature certificate



Step 3 Click **Browse** and then select certificate and credential file.

Step 4 Click **Install**.

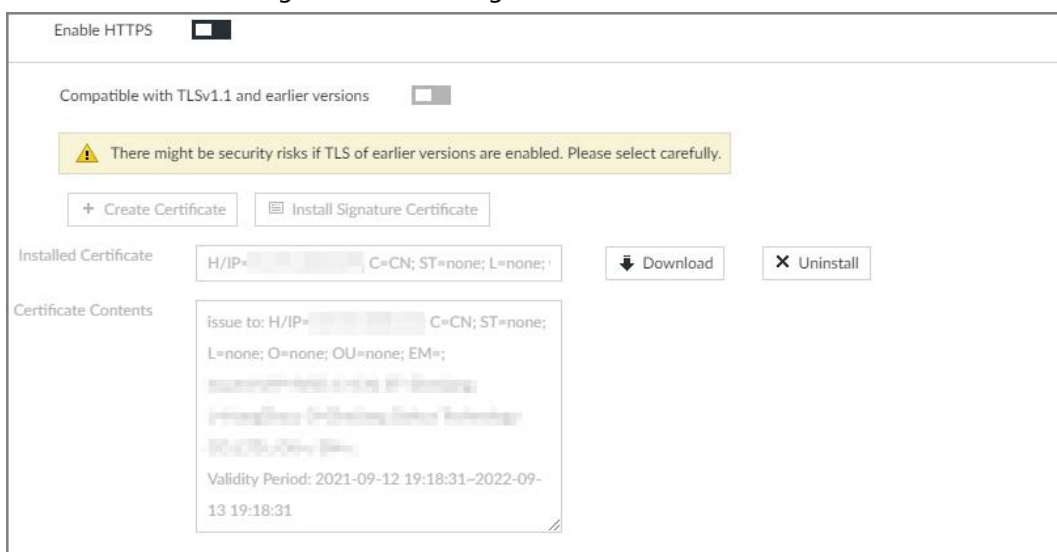
System begins to install certificate, and then displays certificate information after the

installation.

Step 5 Install the root certificate on the PC. See "8.6.1.1.1 Installing the Created Certificate" for detailed information.



This root certificate is the one obtained with signed certificate.

8.6.1.2 Enabling HTTPS

After you install the certificate and enable HTTPS function, you can use the HTTPS on the PC to access the device.

Step 1 Click or click on the configuration page, and then select **SECURITY > Credential**.

Step 2 Click to enable HTTPS function.

Step 3 Click to enable **Compatible with TLSv1.1 and earlier versions**.



TLS (Transport Layer Security) provides privacy and data integrity between two communications application programs.

Figure 8-92 Credential

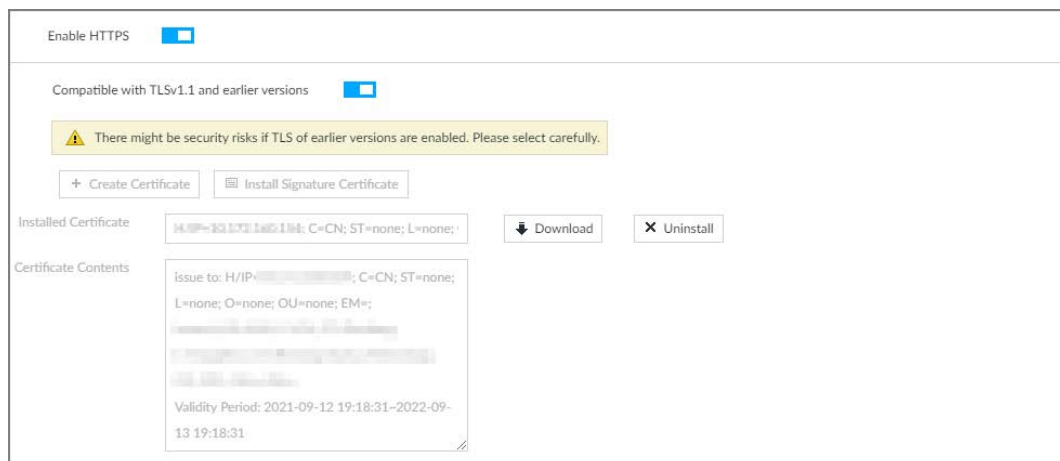

Step 4 Click **Save**.

After you successfully save the settings, you can use HTTPS to access the web interface. Open the browser, enter `https://IP address:port` in the address bar, and then press Enter, and the login page is displayed.



- IP address is device IP or the domain name.
- Port refers to device HTTPS port number. If the HTTPS port is the default value 443, just use `https://IP address` to access.

8.6.1.3 Uninstalling the Certificate

Uninstall the certificate.



- You cannot use the HTTPS function after you uninstall the certificate.
- The certificate cannot be restored after being uninstalled. Be cautious.



Step 1 Click , or click  on the configuration page, and then select **SECURITY > Credential**.

Figure 8-93 Uninstall



Step 2 Click **Uninstall**.

System pops up a confirmation box.

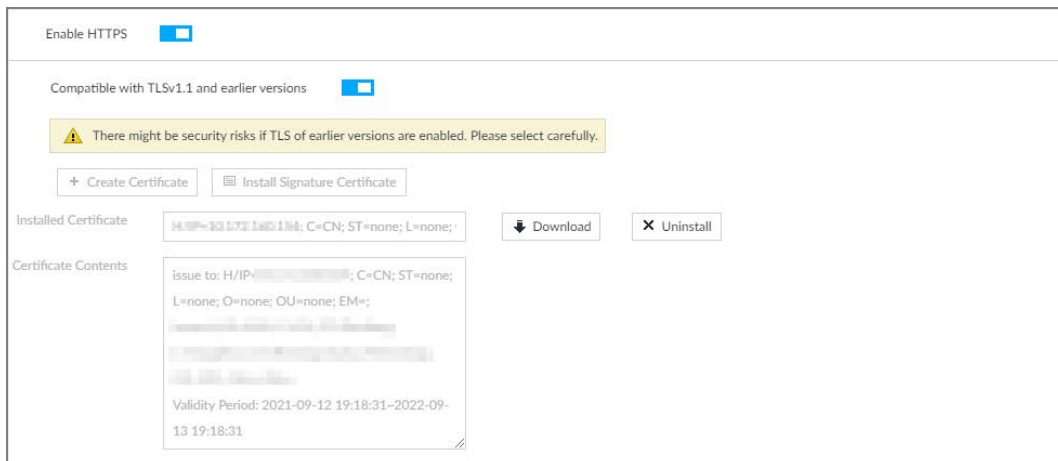
Step 3 Click **OK** to uninstall the certificate.

8.6.2 Configuring Access Permission

Set the specified IP addresses to access the device, to enhance device network and data security.



Step 1 Click , or click  on the configuration page, and then select **SECURITY > IP Filter**.

Figure 8-94 IP Filter



Step 2 Select IP access rights.

- **Allow all access:** It is to allow all IP addresses in the same IP segment to access the device.

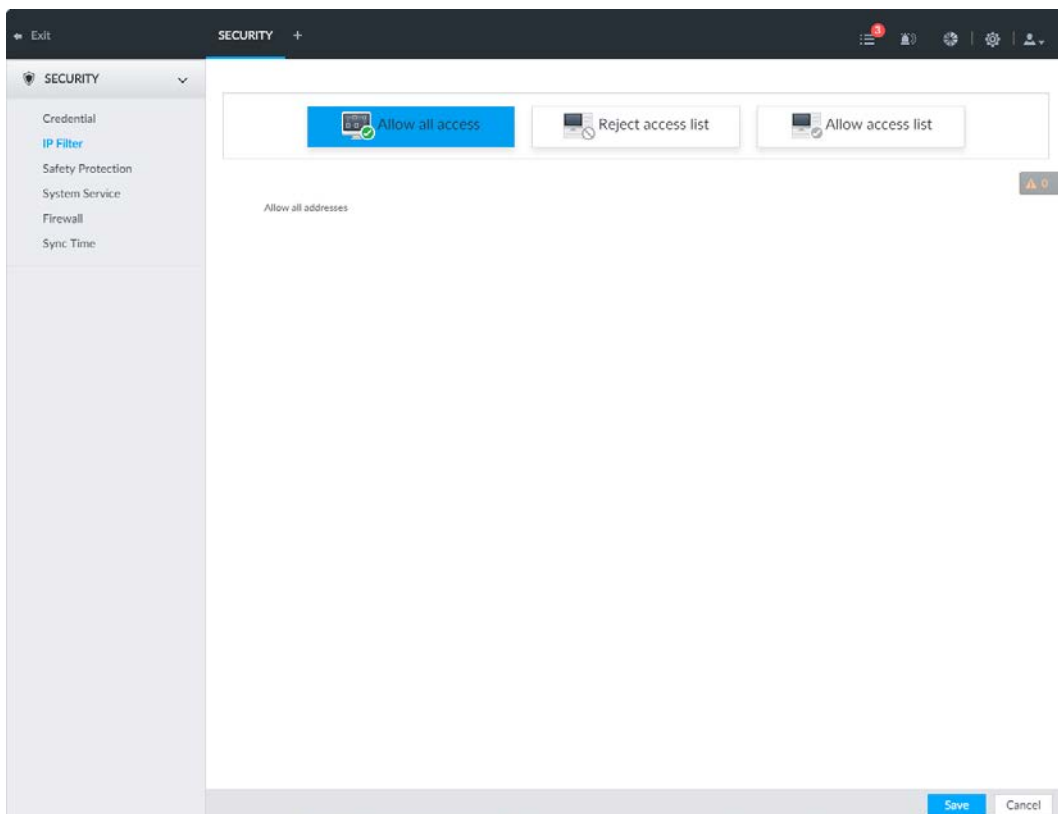
- Reject access list: It means the IP address in the list cannot access the device.
- Allow access list: It means the IP address in the list can access the device.

Step 3 Add IP host.



The following steps are to set reject access list or allow access list.

- 1) Click **Add**.
- 2) Select **Add Type**, and set IP address or MAC address of IP host.
 - Single IP: Enter host IP address.
 - IP segment: Enter IP segment. It can add multiple IP addresses in current IP segment.
 - MAC: Enter MAC address of IP host.
- 3) Click **OK** to add the IP host.
System displays added IP host list.



- Click **Add** to add more IP hosts.
- Click  to edit the IP host.
- Select an IP host and then click **Delete** to delete.

Step 4 Click **Save**.

8.6.3 Safety Protection

Set the login password lock strategy once the login password error has exceeded the specified threshold within the defined time period. System can lock current IP host for a period of time.



- Step 1 Click , or click  on the configuration page, and then select **SECURITY > Safety Protection**.

Figure 8-95 Safety protection (1)



- Step 2** Click to enable security protection function.
- Remote: When you are using web interface, PCAPP to access the device remotely, once the login password error has exceeded the threshold within the defined time period, system locks the IP host for a period of time.
 - Local: When you are accessing local menu of the device, once the login password error has exceeded the threshold within the defined time period, system locks the account for a period of time.
- Step 3** Set lock strategy according to the actual situation.
- Step 4** Click **Save**.
- Once the IP host has been locked, you can view the locked IP host on the list. Select an IP host and then click **Unlock**, or click the of the corresponding IP host to unlock.
- Step 5** (Optional) Click **Login lock event** to go to the **Event** page where you can select **Abnormal Event** > **Lock in** to configure a **Lock in** event.

8.6.4 Enabling System Service

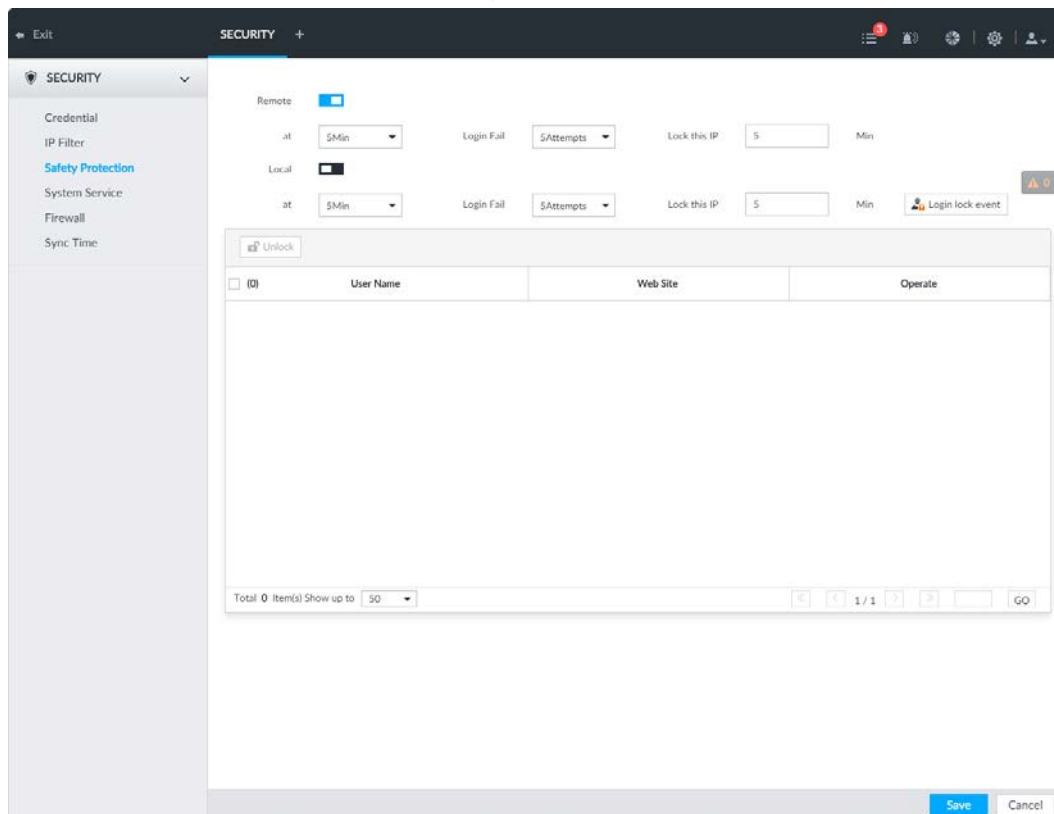
Enable system services for third-party access.

- Step 1** Click , or click on the configuration page, and then select **SECURITY** > **System Service**.

Figure 8-96 System service

Step 2 Enable or disable system service according to your actual situation.

Table 8-31 System service

System service	Description
SSH	<p>After enabling this function, you can access the Device through SSH protocol to carry out system debugging and IP configuration. This function is disabled by default.</p> <p> You are recommended to disable this function. Otherwise there might be security risks.</p>
Mobile Phone Push	<p>After enabling this function, you can access the Device with mobile phone client to receive information from the Device.</p> <p> You are recommended to disable this function. Otherwise there might be security risks.</p>
CGI Enable	<p>After this function is enabled, third-party platform can connect the Device through CGI protocol.</p> <p> You are recommended to disable this function. Otherwise there might be security risks.</p>
ONVIF Enable	<p>After this function is enabled, other devices can connect the Device through ONVIF protocol.</p> <p> You are recommended to disable this function. Otherwise there might be security risks.</p>
Run Log	<p>After enabling it, you can view system running logs in Intelligent Diagnosis > Run Log.</p>

System service	Description
Password Expires in	Configure the password expiration interval. The Device prompts you to change the password when the password expires.
Audio/Video Transmission Encryption	When this function is enabled, stream transmission will be encrypted.  We recommend you enable this function. Otherwise you might risk data leakage.
RTSP over TLS	Enable this function to encrypt stream transmission. You are recommended to enable this function. Otherwise you might risk data leakage.
Private Protocol Authentication Mode	Select a private protocol authentication mode between security mode and compatible mode. Security mode is recommended.

Step 3 Click **Save**.

8.6.5 Configuring Firewall

Enhance network and data security by prohibiting Ping and half-connection.

- **PING Prohibited:** When **PING Prohibited** is enabled, the device does not respond to Ping requests.
- **Anti Half Connection:** When **Anti Half Connection** is enabled, and the device can provide service normally under half-connection attack.

Step 1 Click , or click  on the configuration page, and then select **SECURITY > Firewall**.

Figure 8-97 Firewall

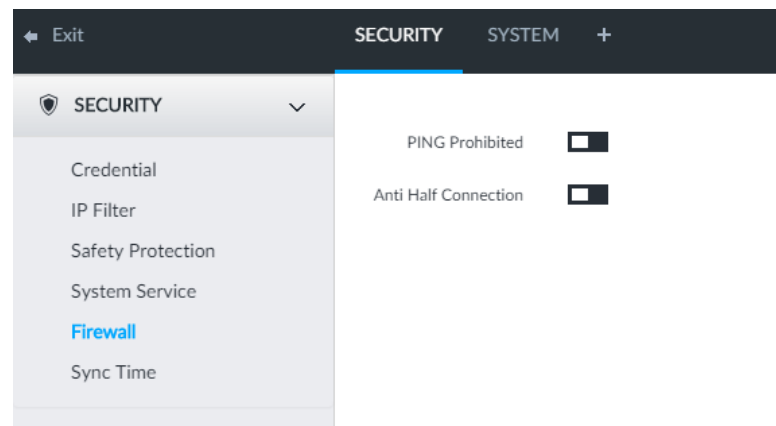

Step 2 Click to enable PING Prohibited or Anti Hal Connection.

Step 3 Click **Save**.

8.6.6 Configuring Time Synchronization Permission

Configure permissions of time synchronization actions from other devices or servers.

Step 1 Click , or click  on the configuration page, and then select **SECURITY > Synch Time**.

Step 2 Click to enable time synchronization restriction.

Step 3 Select **Allowlist** or **Blocklist**.

- Hosts in the allowlist have the permission to synchronize time of the Device.
- Hosts in the blocklist cannot synchronize time of the Device.

Step 4 On the **Allowlist** page or the **Blocklist** page, add hosts.

- 1) Click **Add**.

Figure 8-98 Add a host

- 2) Select an IP version, and then enter an IP address.
- 3) Click **OK**.

Step 5 Click **Save**.

You can also perform the following functions after configuring the allowlist or blocklist.

Table 8-32 Other functions

Function	Description
Edit IP address	Click to edit IP address.
Delete IP address	Click to delete a host from the list.
Configure IP address permission	Click the corresponding of each host, so as to enable the allowlist or blocklist configuration for the host. Click to disable the allowlist or blocklist configuration for the host.

8.7 Account Management

Device account adopts two-level management mode: user and user group. You can manage their basic information. To conveniently manage the user, we recommend the general user authorities shall be lower than high-level user authorities.



- To ensure device safety, enter correct login password to operate the **ACCOUNT** page (for example, add or delete user).
- After a correct login password is entered on the **ACCOUNT** page, if you do not close the **ACCOUNT** page, you can do other operations directly. If you close the page and enter it again, you shall enter the correct login password again.

8.7.1 User Group

Different users might have different authorities to access the device. You can divide the users to different groups. It is easy for you to maintain and manage the user information.

- System supports maximum 64 user groups. User group name supports maximum 64 characters.

- System has two default user groups (read-only): admin and ONVIF.
- Create new user group under the root.

8.7.1.1 Adding User Group

- Step 1** Click or click on the configuration page, and then select **ACCOUNT**.
- Step 2** Select the root node in the device tree on the left and then click at the lower-left corner.
- Step 3** Enter current user's login password, and then click **OK**.
System creates one user group and displays the **Property** page.

Figure 8-99 User group property

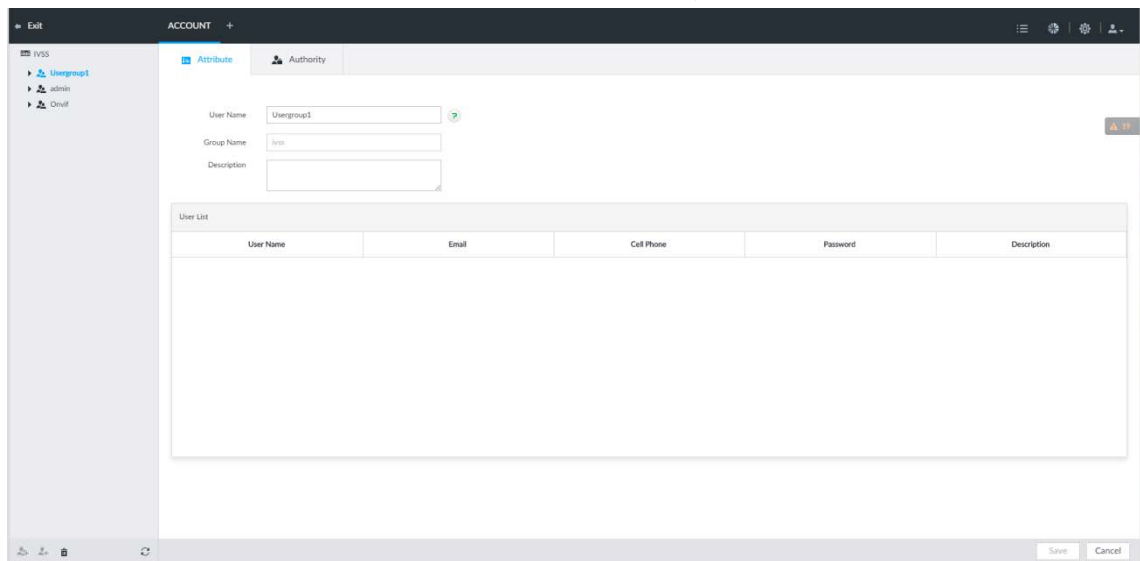

- Step 4** Set parameters.

Table 8-33 User group

Parameters	Description
Name	Set user group name. The name ranges from 1 to 64 characters. It can contain English letters, number and special character ("_", "@", ".").
Group name	Displays user group organization node. System automatically recognizes the group name.
Description	Enter user group description information.
User list	Displays user information of current group.

- Step 5** Select user authority.
- 1) Click **Authority** tab.

Figure 8-100 Authority

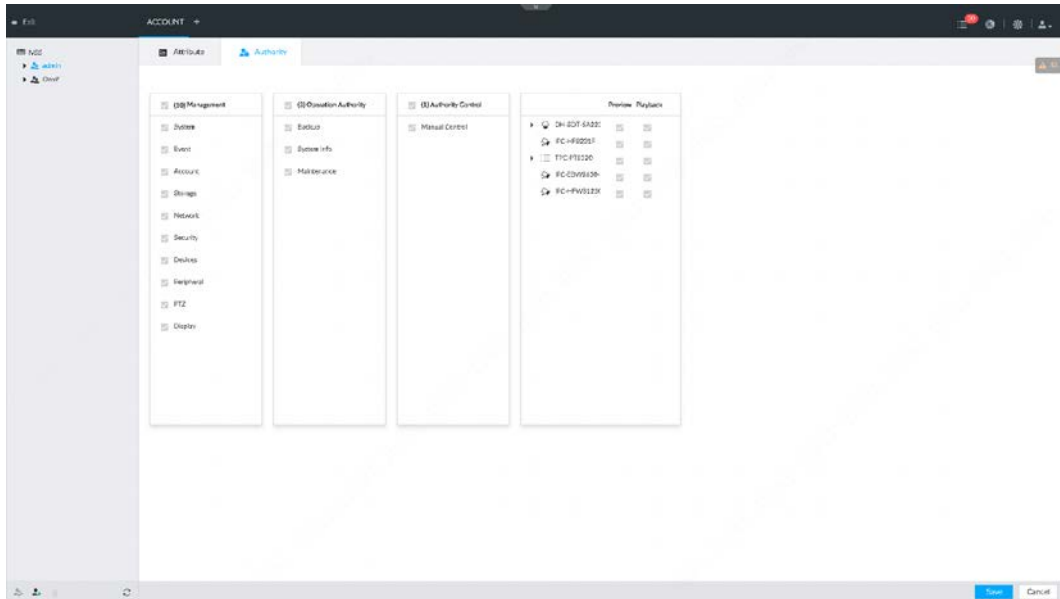

2) Set user group authorities according to actual situation.

- : means it has the corresponding authority.
- Check the box at the top of the authority list (such as (0) Authority Control) to select all authorities of current category.

Step 6 Click **Save**.

8.7.1.2 Deleting User Group



- Before you delete a user group, delete all users of current group first. User group cannot be restored after being deleted. Be cautious.
- Admin and ONVIF user cannot be deleted.

Step 1 Click , or click  on the configuration page, and then select **ACCOUNT**.

Step 2 Select user group and click .

Step 3 Enter current user's login password, and then click **OK**.

Step 4 Click **OK** on the prompt page.

8.7.2 Device User

The device user is to access and manage the device. System default administrator is admin. It is to add a user and then set corresponding authorities, so that the user can access the resources within its own rights range only.



User authorities adopt the user group authorities settings. It is read-only.

8.7.2.1 Adding a User

Step 1 Click , or click  on the configuration page, and then select **ACCOUNT**.

Step 2 Select admin user group or other newly added user group, and then click  at the lower-

left corner.

Step 3 Enter current user's login password, and then click **OK**.

Figure 8-101 Property

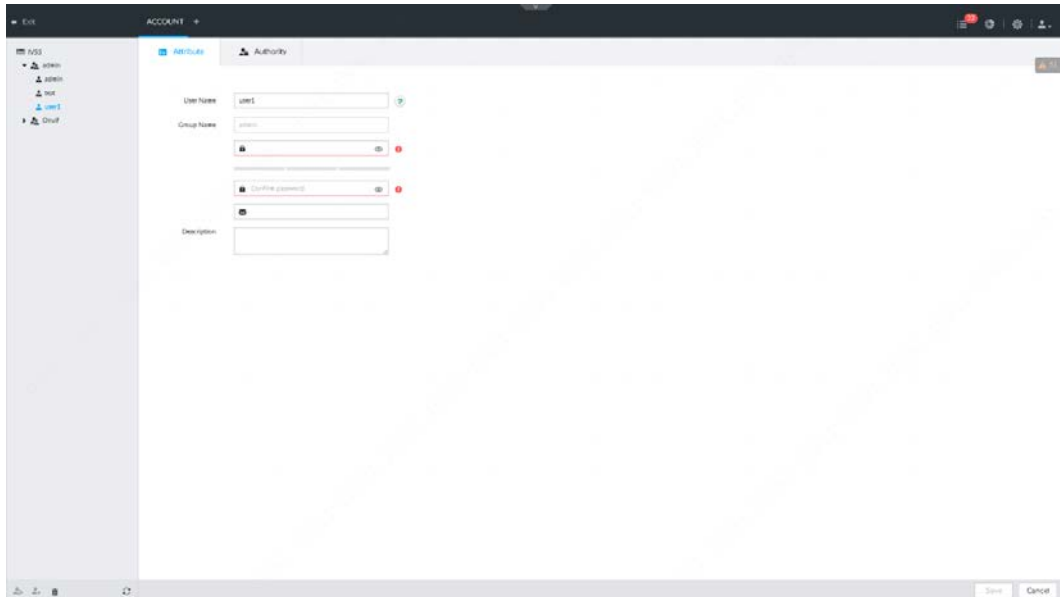

Step 4 Set parameters.

Table 8-34 User management

Parameters	Description
Name	Set username. The name ranges from 1 to 31 characters. It can contain English letters, number and special character ("_", "@", ".").
Group name	Displays user organization node. System automatically identifies it.
Password	In the new password box, enter the new password and enter it again in the Confirm Password box.
Confirm Password	The password ranges from 8 to 32 non-empty characters. It can contain letters, numbers and special characters (excluding ";& and space) .The password shall contain at least two categories. Usually we recommend the strong password.
Description	Enter user description information.

Step 5 (Optional) Click **Authority** tab to view user authority.

Figure 8-102 Authority

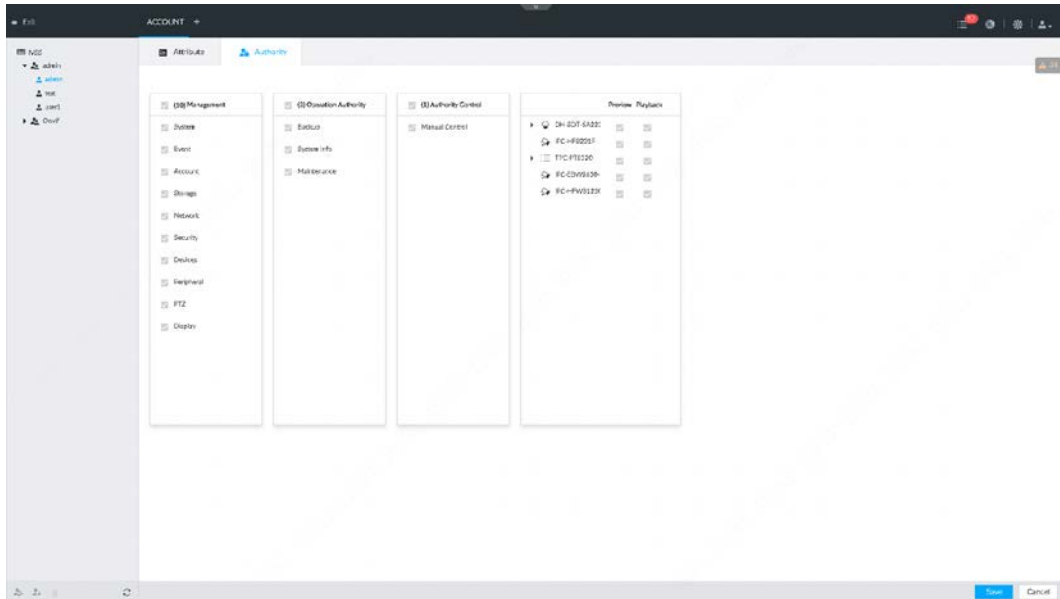

Step 6 Click **Save**.



8.7.2.2 Operation

After adding a user, you can modify user information or delete the user.



The user with account management authority can change its own and other users' information.

Table 8-35 User operation

Name	Operation
Edit user information	Select a user from user list. The Property page of the user is displayed, and the user's login password and description information can be modified.
Delete User	Select a user from user list, and then click  to delete.  <ul style="list-style-type: none"> Before deleting an online user, block the user first. For details, see "9.6.1 Online User". User information cannot be restored after being deleted. Be cautious.

8.7.3 Password Maintenance

Maintain and manage user's login password.

8.7.3.1 Changing Password

Change user's login password.

8.7.3.1.1 Changing Password of the Current User

- Step 1** Click at the top right corner, and then select **Modify Password**.
- Step 2** Enter the old password, the new password and then confirm.
- Step 3** Click **OK**.

8.7.3.1.2 Changing Password of Other User



Only **Admin** account supports this function.

- Step 1** Click , or click on the configuration page, and then select **ACCOUNT**.
- Step 2** Select a user.

Figure 8-103 Property

- Step 3** Click .
- Step 4** Enter current user's login password, and then click **OK**.
The **Change Password** page is displayed.

Figure 8-104 Change password

- Step 5 In the **New Password** box, enter the new password and enter it again in the **Confirm Password** box.
- Step 6 Click **OK**.

8.7.3.2 Resetting Password



You can use email address or answer the security questions to reset password once you forgot it. You can only reset password on the local interface of the Device.



When password resetting function is not enabled, the password cannot be reset if the security questions are not set.

8.7.3.2.1 Leaving Email Address and Security Questions

Enable the password reset function, leave an email address and set security questions. You can only use the local interface to set security questions.

- Step 1 Click , or click  on the configuration page, and then select **ACCOUNT**.
- Step 2 Select the root node in the device tree on the left.
- Step 3 Click  to enable the password reset function.
- Step 4 Enter an email address for resetting password.
- Step 5 Set security questions. Only available on the local interface of the Device.
- Step 6 Click **Save**.

8.7.3.2.2 Resetting Password on Local Interface

- Step 1 Connect a display to the Device, and then go to the **Login** page of the Device.

Figure 8-105 Login

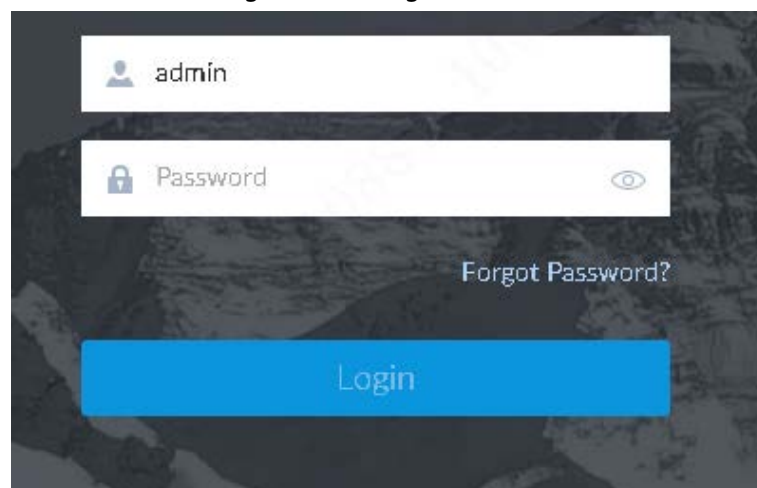

- Step 2 Click **Forgot Password?**.
- Step 3 Click **OK**.
- If you have set the email address information, the QR code is displayed.
 - If you have not set the email address information, the email address interface is displayed. After you set the email address information and click **Next**, the QR code is displayed.

Figure 8-106 Enter email address

Reset Password

1 Password Protection 2 Retrieve Password 3 Set New Password

Email (To reset password)

Email

Next Cancel

Figure 8-107 Scan QR code

Reset Password

1 Retrieve Password 2 Set New Password

Retrieve Password By Email

SN *****Q00019

Scan QR Code

Scan the code on your current interface

1. Use specified APP (DMSS) to scan, APP can automatically send out the data to the server
2. Use non-specified APP to scan, please send QR Code to support_rpwd@global.dahuatech.com

Use specified APP to scan, security code will send to 1***@qq.com Email

Input Security Code ?

Next Cancel

Step 4 Reset the password.

Figure 8-108 Security questions

Reset Password

1 Retrieve Password 2 Set New Password

Retrieve Password

Question 1

* Answer

Question 2

* Answer

Question 3

* Answer

Next Cancel

Step 5 Click **Next**.

Figure 8-109 New password setting

Reset Password

Retrieve Password Set New Password

Confirm Modify Cancel

Step 6 Set parameters.

Table 8-36 Description of password parameters

Parameters	Description
User	The default username is admin.
Password	In the New Password box, enter the new password and enter it

Parameters	Description
Confirm Password	again in the Confirm Password box. The password must consist of 8–32 non-blank characters and contain at least two types of the following characters: Uppercase, lowercase, numbers, and special characters (excluding ' " ; : &). Enter a strong password according to the password strength indication.
Prompt question	After setting the prompt, when you point to  on the login page, the system pops up a prompt to help you remember the password. The prompt question function is for local login page only. See the actual page for detailed information.

- Step 7** Click **Confirm Modify**.
You can log in with the new password.

8.7.3.2.3 Resetting Password on the Web

Prerequisites

Make sure that you have configured the linked email address.

Procedure

- Step 1** Enter the IP address of the Device in the address bar of the browser, and then press Enter.

Figure 8-110 Login

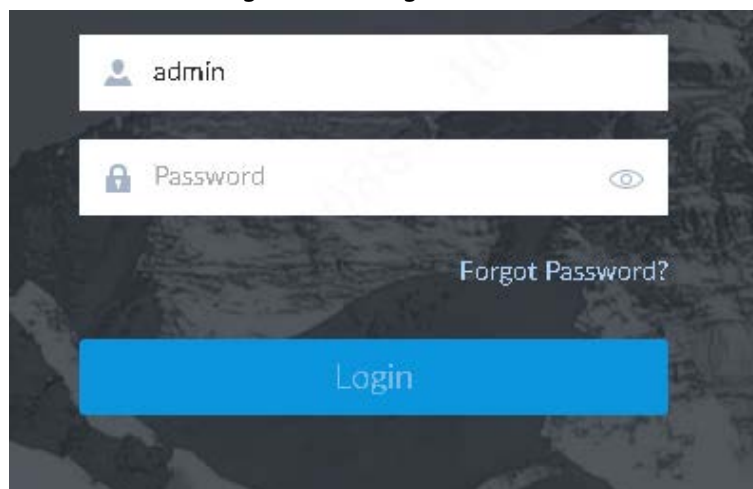

- Step 2** Click **Forgot Password?**.
Step 3 Click **OK**.
Step 4 Follow on-screen instructions to get security code and then enter the security code.

Figure 8-111 Security questions

Step 5 Click **Next**.

Step 6 Set a new password.

Figure 8-112 New password setting

Table 8-37 Description of password parameters

Parameters	Description
User	The default username is admin.
Password	In the New Password box, enter the new password and enter it again in the Confirm Password box.
Confirm Password	The password must consist of 8–32 non-blank characters and contain at least two types of the following characters: Uppercase, lowercase, numbers, and special characters (excluding ' ' ; : &). Enter a strong password according to the password strength indication.

Parameters	Description
Prompt question	After setting the prompt, when you point to  on the login page, the system pops up a prompt to help you remember the password. The prompt question function is for local login only. See the actual page for detailed information.

Step 7 Click **Confirm Modify**.
You can log in with the new password.

8.7.4 ONVIF

When the remote device is connecting with the device through ONVIF protocol, use the verified ONVIF account.



- System adopts three ONVIF user groups (admin, user and operator). You cannot add ONVIF user group manually.
- You cannot add user under ONVIF group directly.

8.7.4.1 Adding ONVIF User

Step 1 Click  or click  on the configuration page, and then select **ACCOUNT**.

Step 2 Select user group under ONVIF.

Figure 8-113 ONVIF

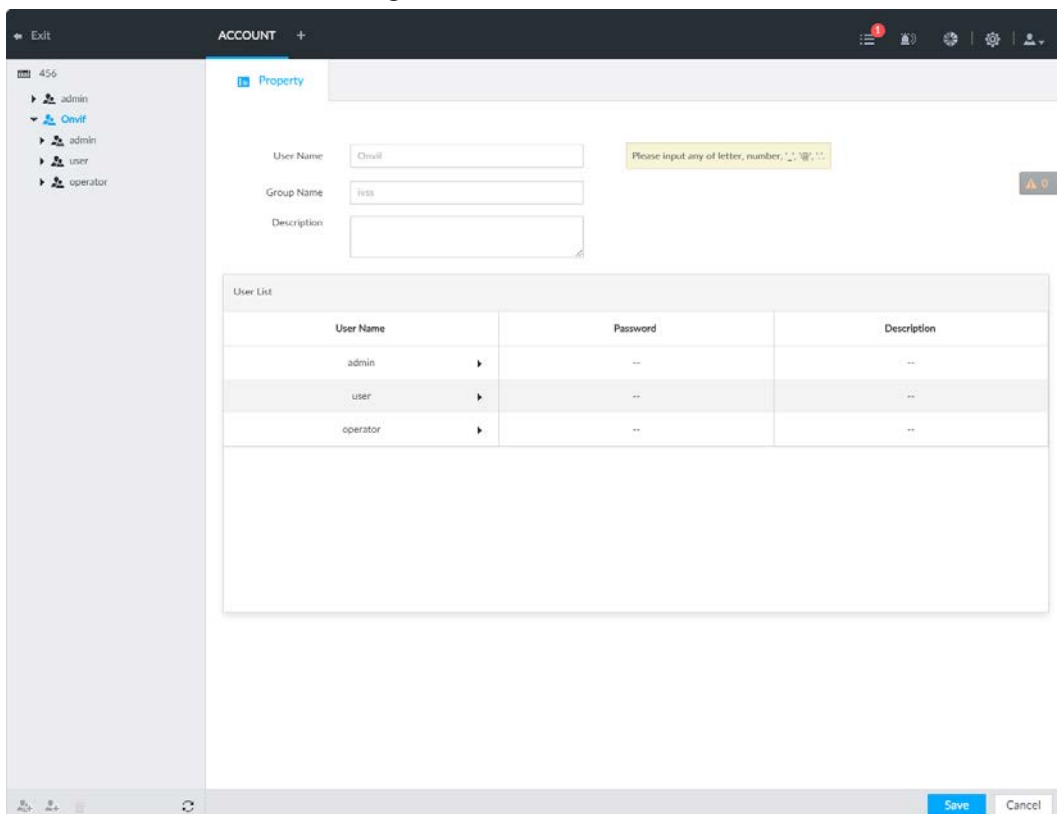

Step 3 Click  at the lower-left corner of the **Property** page.

Step 4 Enter the login password of current user, and then click **OK**.

Figure 8-114 ONVIF property

Step 5 Set parameters.

Table 8-38 ONVIF parameters description

Parameters	Description
username	Set ONVIF username. The name ranges from 1 to 31 characters. It can contain English letters, number and special character (_ @ .).
Group name	Displays user organization node. System automatically identifies it.
Password	Set ONVIF user password.
Confirm Password	The password ranges from 8 to 32 non-empty characters. It can contain letters, numbers and special characters (excluding " ; & and space) .The password shall contain at least two categories. Usually we recommend the strong password.
Description	Enter ONVIF user description information.

Step 6 Click **Save**.

8.7.4.2 Deleting ONVIF User



Deleting the admin account is not supported.

Step 1 Click or click on the configuration page, and then select **ACCOUNT**.

Step 2 Select ONVIF and click .

Step 3 Enter current user's login password, and then click **OK**.

Step 4 Click OK.

8.8 System Configuration



Click  or click  on the configuration page, select **SYSTEM**. The **SYSTEM** page is displayed. Set system basic settings, such as general parameters, time, display parameter, schedule, and voice.

Figure 8-115 System management



8.8.1 Setting System Parameters

Set system language, standard, user logout time, virtual keyboard, and mouse moving speed.

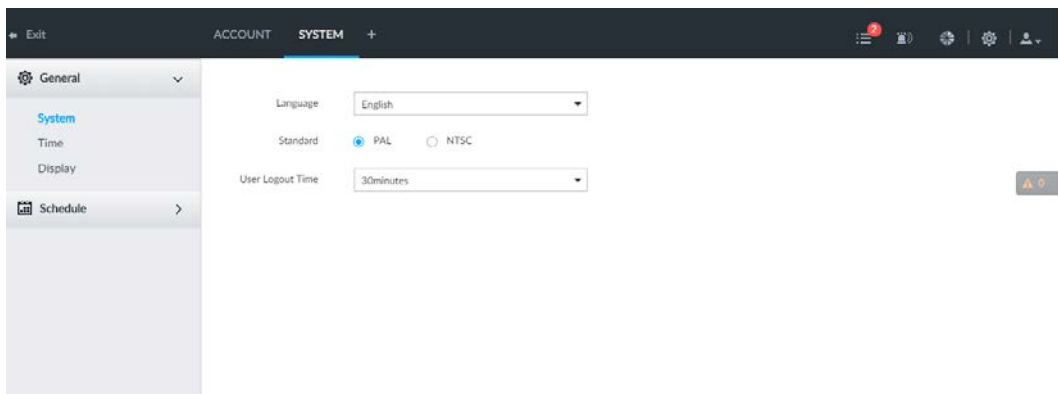

Step 1 Click  or click  on the configuration page, and then select **SYSTEM** > **General** > **System**.



Figure 8-116 Configuring system settings

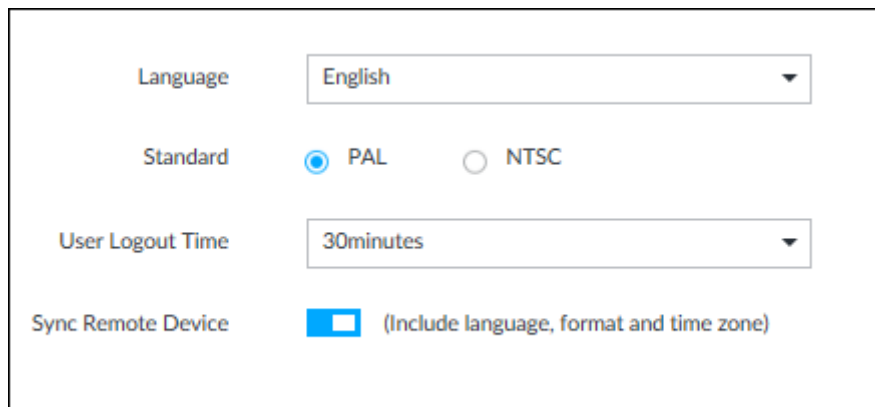

Step 2 Set parameters.

Table 8-39 System parameters description

Parameters	Description
Language	Set system language.

Parameters	Description
Standard	<p>Select video standard.</p> <ul style="list-style-type: none"> • PAL is mainly used in China, Middle East and Europe. • NTSC is mainly used in Japan, United States of America, Canada and Mexico.  <p>As a technical standard of processing video and audio signals, PAL and NTSC mainly differ in encoding, decoding mode and field scanning frequency.</p>
User Logout Time	<p>Set auto logout interval once you remain inactive for a specified period or the device exceeds the set value. After auto logout, the user needs to login again to operate.</p> <p>If you select No Logout, system does not automatically log out.</p>
Sync Remote Device	<p>Click <input type="checkbox"/> to enable the function. If enabled, the language, standard and time settings configured here will be synchronized to all the connected remote devices.</p>
Virtual Keyboard	<p>Enable virtual keyboard function on the local menu. See "Appendix 2.2 Virtual Keyboard" for detailed information.</p>  <p>This function is for local menu only.</p>
Mouse Moving Speed	<p>Set mouse moving speed on the local interface.</p>  <p>This function is for local menu only.</p>

Step 3 Click **Save**.

8.8.2 System Time

Set system time, and enable NTP function according to your need. After enabling NTP function, device can automatically synchronize time with the NTP server.



Step 1 Click , or click  on the configuration page, and then select **SYSTEM > General > Time** .

Figure 8-117 Time

Step 2 Set parameters.

Table 8-40 System parameters description

Parameters	Description
Time	Set system date and time. You can set manually or set device to synchronize time with the NTP server. <ul style="list-style-type: none"> Manual Setting: Select Manual Setting and then set the actual date and time in the following two ways. <ul style="list-style-type: none"> Click and then set the time and date in the calendar. Click Sync to synchronize device time with your PC. Sync with the Internet Time Server: Select the checkbox, enter NTP server IP address or domain, and then set Auto Sync Time Interval.
Time and Date Format	Set time and date display format.
Time Zone	Set device time zone.
Auto Time Synchronization	After enabling this function, IVSS detects system time of remote device once in every interval. When time of remote device is inconsistent with IVSS time, IVSS will calibrate the time of remote device automatically.

Step 3 (Optional) Set DST.



DST is a system to stipulate local time, in order to save energy. If the country or region where the device is located follows DST, you can enable DST to ensure that system time is correct.

- 1) Click to enable DST.
- 2) Select DST mode. It includes **Date** and **Week**.
- 3) Set DST start time and end time.

Step 4 Click **Save**.

8.8.3 Display

Set connected display resolution and refresh rate.

Step 1 Click or click on the configuration page, and then select **SYSTEM > General > Display**.

Figure 8-118 Display

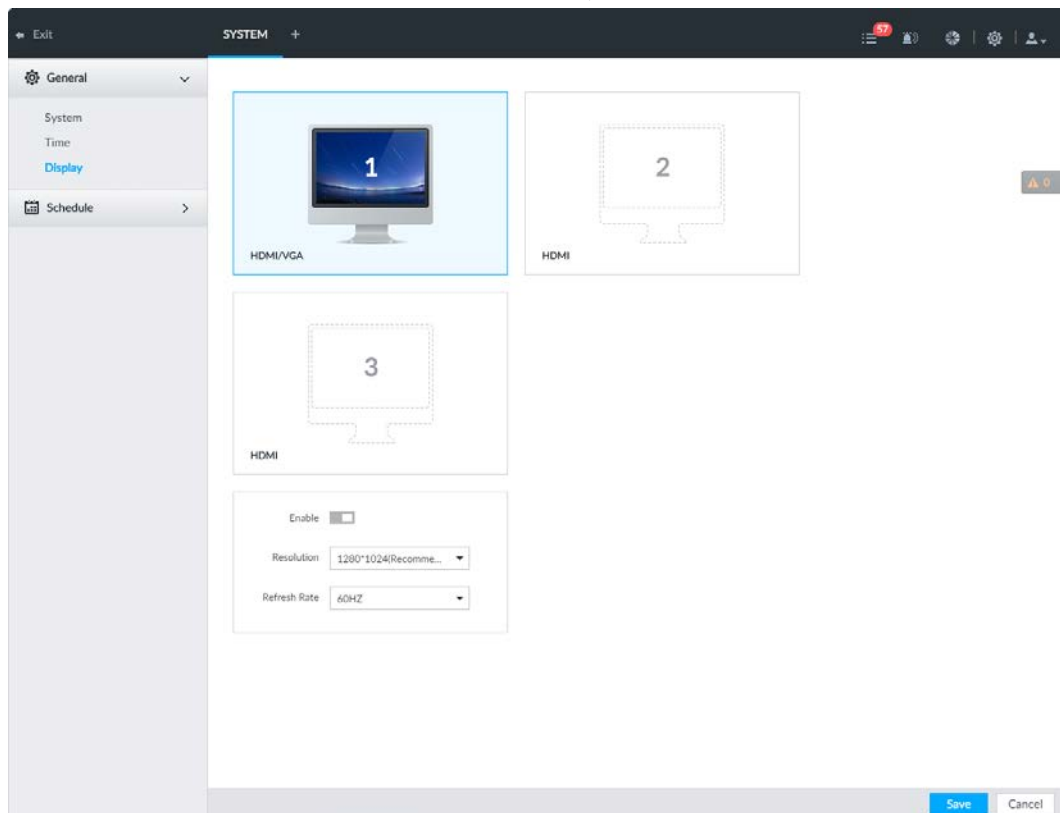

- SN 1–3 refers HDMI 1–HDMI 3. Among which, HDMI/VGA is the main display, while the VGA and HDMI 1 outputs the same video.
- VGA and HDMI 1 are outputting the same video source. Three HDMI ports can output different video sources.
- means display is connected and enabled. means display is connected but has not enabled. means display is disconnected.

Step 2 Select a display.

Step 3 Click to enable the selected display.

Step 4 Set parameters.

Table 8-41 Display parameters description

Parameters	Description
Resolution	Set display resolution. Different displays support different resolutions. See your actual interface for detailed information.
Refresh rate	Set refresh rate of the display.

Step 5 Click **Save**.

8.8.4 Schedule

Set schedule. When you are configuring alarm, record arm/disarm period, system can call the schedule directly. System only triggers the corresponding operations during the specified schedule.



Default schedule has been created by default. Default schedule is **Always Effective**, and cannot be modified or deleted.





Step 1 Click , or click  on the configuration page, and then select **SYSTEM > Schedule > Schedule**.

Figure 8-119 Schedule

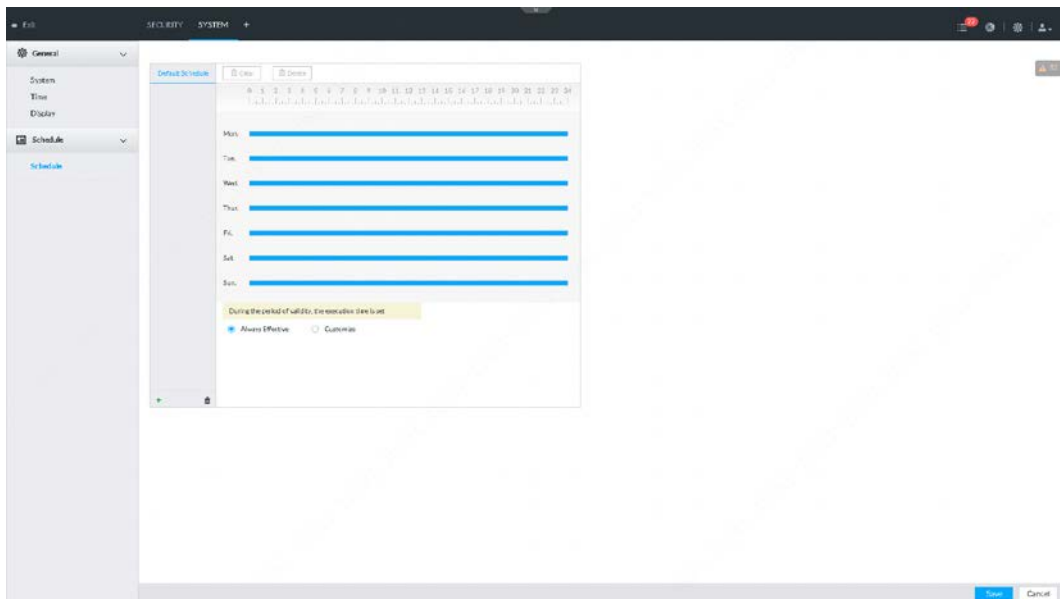

Step 2 Add schedule.

- 1) Click .
- 2) Set schedule name.
- 3) Click **OK** to save the configuration.



Step 3 Set valid time period. It includes **Always Effective** and **Customize**.

Step 4 Set validity period of schedule.



- The step is for customized mode only.
- Each calendar supports maximum 50 validity periods.
- The blue area on the time bar means the validity period.

On the time bar, you can:

- Click the blue area, and  is displayed. Drag  to adjust the start time and end time of validity period.
- Press the any blank space on the time bar, and drag to the right to add a validity period.
- Click **Clear** to clear all validity periods of current schedule.
- Select a validity period, and then click **Delete** to delete the period.

Step 5 Click **Save**.



Select an added schedule, and then click  to delete.

8.9 Cluster Service

The cluster function, also known as cluster redundancy, is a kind of deployment method that can improve the reliability of device. In the cluster system, there is a number of main devices and another number of sub devices (the N+M mode), and they have a virtual IP address (the cluster IP) for unified login and management. Under normal circumstances, the main devices are in the working state. When the main device fails, the corresponding sub device will take over the job automatically. When the main device recovers, the sub device will transmit the configuration data, cluster IP address and videos recorded during the failure to the main device which then takes over the job again.

In the N+M cluster system, there is a management server, the DCS (Dispatching Console) server, which is responsible for timely and correct scheduling management of the main and sub devices. When you create a cluster, the current IVSS is used as the first sub device and the DCS server by default.

8.9.1 Configuring Cluster

Create cluster, view cluster details, recover main devices and configure the arbitration IP address.



8.9.1.1 Creating a Cluster

Creating a cluster is to add multiple devices into a cluster that requires the addition of main and sub devices and the configuration of cluster IP.

When you create a cluster, the current Device is taken as the first sub device and the DCS server by default, and the priority of the other sub devices is determined by the order in which they are added, with the first sub device being the highest priority.

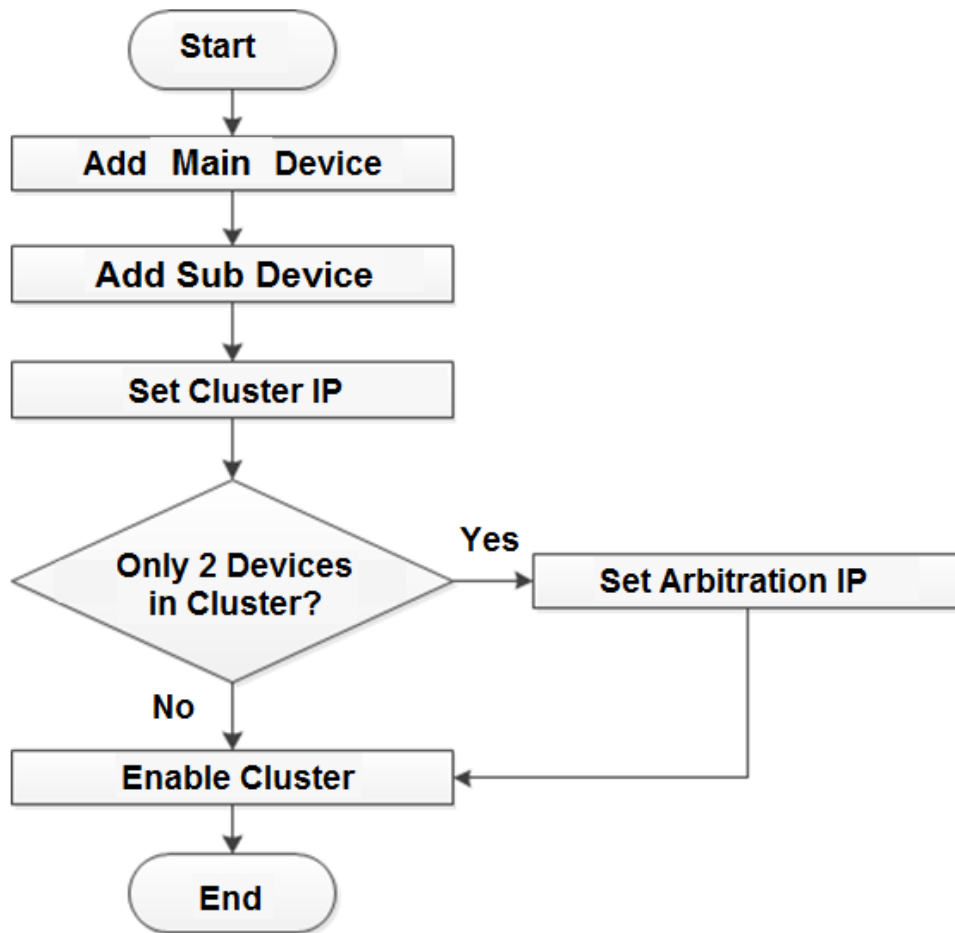
Figure 8-120 Procedure of creating a cluster



Step 1 Click , or click  on the configuration page, and then select **CLUSTER SERVICE > CLUSTER**.

Step 2 Add a main device or sub device.

1) Click **Add**.

Figure 8-121 Add cluster

Device Type	Main Device	
Device Name	<input type="text"/>	
IP Address	<input type="text"/>	
Port	37777	(1-65535)
User Name	admin	
Password	<input type="text"/>	

2) Set parameters.

Table 8-42 Parameters description

Parameters	Description
Device Type	Select main device, or sub device as needed.
Device Name	Name the device.

Parameters	Description
IP Address	Enter the IP address of the main device or sub device. When adding the first sub device, you need not enter the IP address, because the first sub device is the current device by default.
Port	37777 by default.
User Name	Username and password of the device, which are also used to log in to the web interface or PCAPP.
Password	

3) Click **OK**.

Step 3 Click **Start Cluster**.



For a cluster of only 2 devices, you must set the arbitration IP address. For details. See "8.9.1.3 Configuring Arbitration IP".

Step 4 Set cluster IP address.



Cluster IP is a virtual IP that is used to access and manage the main devices and sub devices in the cluster. After logging in with the virtual IP, when the main device fails and the system is switched to the sub device, you can still view live video.

1) Click **Cluster Setting**.

Figure 8-122 Set cluster IP

2) Select the **Enable** checkbox, and then set the other parameters as required.

3) Click **OK**.

8.9.1.2 Viewing Details

Click that corresponds to a main or sub device to view device event logs including event time, name and details.

Figure 8-123 Event log

Event Info ×		
Time	Name	Reason
2019-10-23 09:19:30	Connection failed.	Main connection failed.

8.9.1.3 Configuring Arbitration IP

When there are only 2 devices in the cluster, a third-party device is required to determine whether the main device is faulty, so arbitration IP must be set for the cluster to perform a normal replacement operation. The arbitration IP can be the IP address of another device, PC or gateway that is connected to the device.

Step 1 Click or click on the configuration page, and then select **CLUSTER SERVICE > CLUSTER**.

Step 2 Click **Arbitrage IP**.

Figure 8-124 Set arbitration IP

Setting ×

Preferred IP

Alternate IP

Note: In 1+1 mode, arbitration IP must be set. Arbitration IP address can accessed by all device nodes, for example IP of web client.

Step 3 Set the preferred IP and alternate IP.

Step 4 Click **OK**.

8.9.2 Record Synchronization

After the main device has recovered, the recordings on the sub device during the failure period need to be transmitted back to the main device.

Step 1 Click or click on the configuration page, and then select **CLUSTER SERVICE > Record Transfer**.

Step 2 Click **Add**.

Figure 8-125 Add

Main Device	<input type="text" value="1 . 0 . 0 . 1"/>
Sub Device	<input type="text" value="1 . 0 . 0 . 1"/>
Channel No	<input type="text" value="1"/> +
Start Time	<input type="text" value="2019 - 10 - 23 00 : 00 : 00"/>
End Time	<input type="text" value="2019 - 10 - 23 23 : 59 : 59"/>

Step 3 Set parameters.

Table 8-43 Parameters

Parameters	Description
Main Device	Main device IP.
Sub Device	Sub device IP.
Channel No.	Select the channel of which the video is to be transferred. Click + to set the channel range.
Start Time	The start and end time of the video.
End Time	

Step 4 Click OK.

8.9.3 Viewing Cluster Log



Step 1 Click , or click  on the configuration page, and then select **CLUSTER SERVICE > Cluster Log**.

Figure 8-126 Cluster log

Step 2 Set search time, and then click **Search**.
The logs during the set time period are displayed.

9 System Maintenance

Click **+** on the LIVE page, and select **MAINTAIN**.

You can operate and maintain the device working environment to guarantee proper operation.

Figure 9-1 Maintain

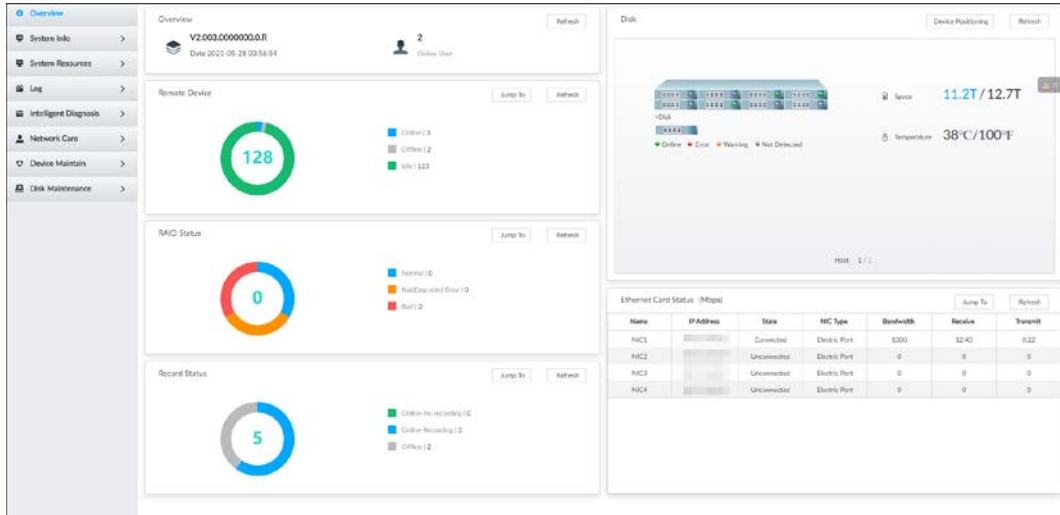

9.1 Overview

Click **+** on the LIVE page, and select **MAINTAIN > Overview**.

Figure 9-2 Overview

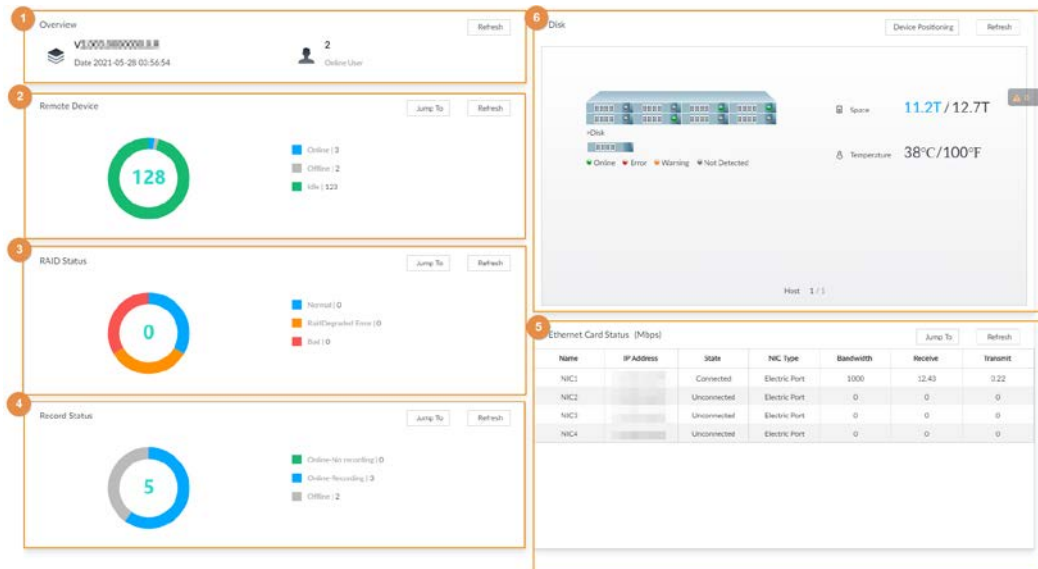





Table 9-1 Overview

No.	Function	Description
1	Overview	View device version details and online users. Click Refresh to refresh the data.

No.	Function	Description
2	Remote Device	View the connection and idle status of remote devices <ul style="list-style-type: none"> • Click Jump To to go to the DEVICE page for detailed information. • Click Refresh to refresh the data.
3	RAID Status	View RAID status. <ul style="list-style-type: none"> • Click Jump To to go to the STORAGE page for detailed information. • Click Refresh to refresh the data.
4	Record Status	View recording status of remote devices. <ul style="list-style-type: none"> • Click Jump To to go to the VIDEO RECORDING page for detailed information. • Click Refresh to refresh the data.
5	Ethernet Card Status (Mbps)	View NIC status. <ul style="list-style-type: none"> • Click Jump To to go to the TCP/IP page for detailed information. • Click Refresh to refresh the data.
6	Disk	View disk status, device temperature and storage usage. <ul style="list-style-type: none"> • Click Device Positioning, and then the device positioning indicator flashes. In this way, you can quickly find the device. • Click Refresh to refresh the data. <ul style="list-style-type: none"> ◇  indicates that the disk is online. ◇  indicates that the disk is in exception. ◇  indicates that the slot has no disk.

9.2 System Information

9.2.1 Viewing Device Information

View device information such as input bandwidth, system version, and web version.

Click  on the **LIVE** page, and select **MAINTAIN > System Info > Device Info**.

Figure 9-3 Device info

Type	[REDACTED]
SN	[REDACTED]
MAC1	[REDACTED]
MAC2	[REDACTED]
MAC3	[REDACTED]
MAC4	[REDACTED]
Video In/Out	5/128
Input bandwidth	9.6Mbps/400.00Mbps
Video Out	3
Audio In/Out	1/2
Alarm In/Out	16/8
System Version	V2.00000000000000000000, Build Date:2021-05-28 03:56:54
Security Baseline Version	V2.1
WEB Version	V1.00000000000000000000
ONVIF Client Version	V2.4.1
ONVIF Server Version	20.12(V3.0.0.1056059)

9.2.2 Viewing Legal Information

View device software license, privacy policy, and open-source software note.

Click on the LIVE page, and select **MAINTAIN > System Info > Legal Info**.

9.2.3 Viewing Algorithm Version

View device algorithm license status and AI version information.

Click on the LIVE page, and select **MAINTAIN > System Info > Algorithm Version**.

Figure 9-4 Algorithm version

Name	Version
Face Detection	16.000.000000.0 & 16.000.000000.000000
Face Recognition	16.000.000000.0 & 16.000.000000.000000
Video Metadata	16.000.000000.0 & 16.000.000000.000000
IVS	16.000.000000.0 & 16.000.000000.000000
Face Eigenvector	16.000.000000.0
Human Body & Non-motor Vehicle Eigenvector	16.000.000000.000000.000000.000000.000000

9.3 System Resources

View device and AI module information.

9.3.1 Viewing Device Resource

Click **+** on the LIVE page, and select **MAINTAIN > System Resources > DEIVCE INFO**.

The **System Resources** page is displayed. You can view resource status including CPU and memory usage, panel temperature and fan speed.

Figure 9-5 System resources

Detection Item	Type	Value
Memory	Used Space/Total Space	2.35GB/7.67GB
CPU	CPU Usage	7%
MainboardFan1	Fan Speed	1890r/min
MainboardFan2	Fan Speed	1829r/min
Mainboard1	Temperature	42°C
Mainboard2	Temperature	33.5°C
Mainboard3	Temperature	32.75°C
Mainboard4	Temperature	34.75°C
CPU	Temperature	38°C

- Click  to filter the search conditions.
- Click **Refresh** to refresh the data.

9.3.2 Viewing AI Module Information

Click **+** on the LIVE page, and select **MAINTAIN > System Resources > AI Module Info**. You can view status of the AI modules.

Figure 9-6 AI module information

Name	State
intelModule_1	

9.4 Logs

The logs record all kinds of system running information. Check the log periodically and fix the problems in time to guarantee system proper operation.

9.4.1 Log Classification

Search system log, user log, event log, and link log.

Table 9-2 Log description

Log	Type
System log	Search system log. It includes logs of system running status, file management, hot spare, hardware detect and scheduled task.
User operation log	Search user operation log. It includes user operation and user configuration log.
Event log	Search alarm event log. It includes logs of cross line detection, storage error, storage full, lock in, power fault, video motion, fan speed alarm, face detection, face recognition, human detect, device offline, tampering, no HDD, IPC offline, AI module offline, AI module temp, IO alarm, IP conflict, MAC conflict, and cross region detection.
Link log	Search device link log. You can search or export link log including user login/logout, session hijack, session blast and remote device.

9.4.2 Log Search

The following steps are to search system log. See the actual page for detailed information.

Procedure

- Step 1 On the **LIVE** page, click **+**, and select **MAINTAIN > Log > System**.
- Step 2 Set search criteria such as system log level, type and date.
- Step 3 Click **Search**.

Figure 9-7 System log

Type	Level	Time	Description
SyncSystemTime	Notice	2019-12-30 16:00:00	OffTime:2019-12-30 15:59:59; NewTime:2019-12-30 16:00:00 IP Address:171.35.0.46;
SyncSystemTime	Notice	2019-12-30 15:45:46	OffTime:2019-12-30 15:46:09; NewTime:2019-12-30 15:45:46 IP Address:171.35.0.46;
SyncSystemTime	Notice	2019-12-30 15:40:43	OffTime:2019-12-30 15:56:09; NewTime:2019-12-30 15:40:43; Record Type:WebLog IP Address:30.172.33.11;
Task is paused.	Notice	2019-12-30 13:48:42	Task Name:cyrus_11;
Task is started.	Notice	2019-12-30 13:36:45	Task Name:cyrus_11;
Task is paused.	Notice	2019-12-30 13:36:17	Task Name:cyrus_11;
Task is started.	Notice	2019-12-30 13:35:55	Task Name:cyrus_11;
Task is paused.	Notice	2019-12-30 13:33:48	Task Name:cyrus_11;
Task is started.	Notice	2019-12-30 13:33:22	Task Name:cyrus_11;
SyncSystemTime	Notice	2019-12-30 12:52:02	OffTime:2019-12-30 12:52:01; NewTime:2019-12-30 12:52:02 IP Address:171.35.0.46;
StartUp	Error	2019-12-30 12:51:22	Flag:ExitPowerFail;
About	Error	2019-12-30 12:51:22	Time:2019-12-30 12:50:55;
SyncSystemTime	Notice	2019-12-30 12:47:48	OffTime:2019-12-30 12:47:46; NewTime:2019-12-30 12:47:48 IP Address:171.35.0.46;
StartUp	Error	2019-12-30 12:44:58	Flag:ExitPowerFail;
About	Error	2019-12-30 12:44:58	Time:2019-12-30 12:45:52;
SyncSystemTime	Notice	2019-12-30 09:53:33	OffTime:2019-12-30 09:53:33; NewTime:2019-12-30 09:53:19 IP Address:171.35.0.46;
SyncSystemTime	Notice	2019-12-29 16:00:00	OffTime:2019-12-29 15:59:57; NewTime:2019-12-29 16:00:00;

Related Operations

Export and clear log.

Table 9-3 Log operation

Name	Operation
Export log	<p>Click and then the Export window appears. You can select whether to encrypt the exported log information.</p> <ul style="list-style-type: none"> You need to set a password for export encryption. The password is required to unzip the exported file. If you export log in a non-encrypted way, log information will be exported to local PC or USB storage device without encryption. <p> The log information might be overwritten when the disk space runs out. Back up in time.</p>
Clear log	<p>Click Clear all to clear all system logs.</p> <p> You will be unable to track the system error reason if you clear log.</p>

9.5 Intelligent Diagnosis

9.5.1 Run Log

View system running logs for troubleshooting.



Make sure that you have enabled **Run Log** in **SECURITY > System Service**. Otherwise there is no log data.

On the **LIVE** page, click , and select **MAINTAIN > Intelligent Diagnosis > Run Log**.

Figure 9-8 Logs

<input type="checkbox"/> (0)	No.	Type	File Name	Operate
<input type="checkbox"/>	1	core	coredump/core-20191021142751@_JVSS2.000.0000002.0.R_172.12.1.101_123456789012345.gz	↓
<input type="checkbox"/>	2	core	coredump/core-20191021001805@_JVSS2.000.0000002.0.R_172.12.1.101_123456789012345.gz	↓
<input type="checkbox"/>	3	core	coredump/core-20191019220041@_JVSS2.000.0000002.0.R_172.12.1.101_123456789012345.gz	↓

- Click to export a log.
- After selecting multiple logs, click **Export** to export them in batches.

9.5.2 One-click Export

Export the diagnosis data for troubleshooting when the device is in exception.

Step 1 On the **LIVE** page, click , and select **MAINTAIN > Intelligent Diagnosis > One-click Export**.

Step 2 Click **Generate Diagnosis Data** to generate diagnosis data.

Step 3 Click **Export** to export the diagnosis result.

9.6 Network Care

9.6.1 Online User

Search for remote access network user information or you can block a user from access for a period of time. During the block period, the selected user cannot access the Device.



Cannot block yourself or block admin.

Step 1 On the **LIVE** page, click , and select **MAINTAIN > Network Care > Online User**.
The **Online User** page is displayed.



The list displays the connected user information.

Step 2 Block user.

- Block: Click corresponding to the user.
- Batch block: Select multiple users you want to block and then click **Block**.

The **Block** page is displayed.

Figure 9-9 Block

Step 3 Set block period. The default period is 30 minutes.

Step 4 Click **OK** to save the configuration.

9.6.2 Packet Capture

Packet capture is the practice of intercepting a data packet that is crossing or moving over a specific computer network. The captured packet is stored temporarily for analysis. The packet is inspected to help diagnose and solve network problems and determine whether its structure follows network security policies.

Step 1 On the **LIVE** page, click **+**, and select **MAINTAIN > Network Care > Packet Capture**.

Figure 9-10 Packet capture

Nic	IP Address	Address1 : Port1	Address2 : Port2	Size	Capture Backup	Download
Ethernet Network3(Default)		0 Kb	▶	⬇
Ethernet Network2		0 Kb	▶	⬇
Ethernet Network3		0 Kb	▶	⬇
Ethernet Network4		0 Kb	▶	⬇
lo		127.0.0.1	...	0 Kb	▶	⬇

Step 2 In the **Network Test** section, enter the target address, and then click **Test**.

After testing is completed, the test result is displayed. You can check the evaluation for average delay, packet loss, and network status.

Step 3 (Optional) When operating on the local interface, connect a USB storage device to the Device, select the USB device, and then click **Browse** to select the saving path.

Step 4 In the **Packet Capture** section, click **▶** to start capturing the packets of the corresponding NIC, and then click **■** to stop.



- You cannot capture packets of several NICs at the same time.
- During packet capturing, you can go to other pages for operation and go back to the

Packet Capture page later to stop packet capturing.

Step 5 (Optional) When operating on the web or PCAPP, click  to download the captured packet.

9.7 Device Maintenance

Device maintenance is to reboot device, restore factory default setup, or upgrade system and so on. It is to clear the malfunction or error during the system operation and enhance device running performance.

9.7.1 Updating Device

Update device or the AI module version.

9.7.1.1 Updating the Device

You can import the update file to update device version. The update file extension name shall be .bin.



- **During update, do not disconnect from power and network, and reboot or shut down the Device.**
- **Make sure that the update file is correct. Improper update file might result in device error!**

You need to obtain the correct update file and save it in the corresponding path.

- When operating on the local interface, save the update file in the USB storage device and then connect the USB storage device to the IVSS.
- When operating on the web or PCAPP interface, save the update file on the PC in which the web or PCAPP is located.

Step 1 On the **LIVE** page, click , and select **MAINTAIN > Device Maintain > Update > Host**.

Step 2 Click **Browse** to select an update file.

Step 3 Click **Upgrade Now**.

Step 4 Click **OK**.

The system starts updating. Device automatically restarts after successfully updated.

9.7.1.2 Updating AI Module

You can import the update file to update AI module. The update file extension name shall be .bin.



- **During update, do not disconnect from power and network, and reboot or shut down the Device.**
- **Make sure that the update file is correct. Improper update file might result in device error!**

You need to obtain the correct update file and save it in the corresponding path.

- When operating on the local interface, save the update file in the USB storage device and then connect the USB storage device to the IVSS.
- When operating on the web or PCAPP interface, save the update file on the PC in which the Web or PCAPP is located.

- Step 1** On the **LIVE** page, click , and select **MAINTAIN > Device Maintain > Update > AI Module**.
- Step 2** Click **File upgrade**.
- Step 3** Click **Browse** to select an update file.
- Step 4** Click **Upgrade Now**.
- Step 5** Click **OK**.
- The system starts updating. Device automatically restarts after successfully updated.

9.7.1.3 Updating Cameras

You can import the update file to update cameras. The update file extension name shall be .bin.



- During update, do not disconnect from power and network, and reboot or shut down the Device.
- Make sure that the update file is correct. Improper update file might result in device error!

You need to obtain the correct update file and save it in the corresponding path.

- When operating on the local interface, save the update file in the USB storage device and then connect the USB storage device to the IVSS.
- When operating on the web or PCAPP interface, save the update file on the PC in which the Web or PCAPP is located.

Step 1 On the **LIVE** page, click , and select **MAINTAIN > Device Maintain > Update > Camera Update**.

Step 2 Select one or more cameras and then click **File upgrade**.



Stop recording before update. If you are updating a camera that is recording, the following prompt will pop up.

Figure 9-11 Prompt

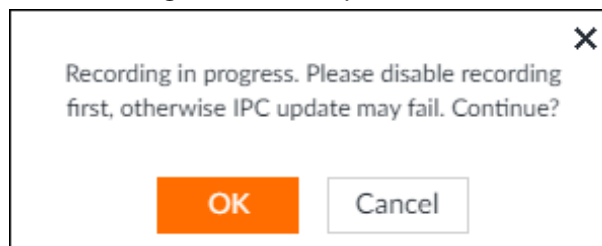

- Step 3** Click **Browse** to select an update file.
- Step 4** Click **Upgrade Now**.
- Step 5** Click **OK**.

9.7.2 Default

When the system runs slowly and has configuration errors, try to solve the problems by restoring the default settings.



All configurations are lost after factory default operation.

Step 1 On the **LIVE** page, click , and then select **MAINTAIN > Device Maintain > Default**.

Figure 9-12 Default



Step 2 Select a method between **Quick Restoration** and **Custom Restoration**.

Step 3 Click **OK**.

System begins to restore default settings. After successfully restored default settings, system prompts to restart the device.

9.7.3 Automatic Maintenance

If the device has run for a long time, you can set to automatically reboot the device at idle time.

Step 1 On the **LIVE** page, click **+**, and then select **MAINTAIN > Device Maintain > Auto Maintain**.

Figure 9-13 Auto Maintain



Step 2 Set auto reboot time.

Step 3 Click **Save**.

Step 4 Enable **Emergency Maintenance**.

When the Device has an upgrade power outage, running error and other problems, and you cannot log in, you can enable **Emergency Maintenance** to restart, clear configuration, and upgrade.

Figure 9-14 Emergency Maintenance

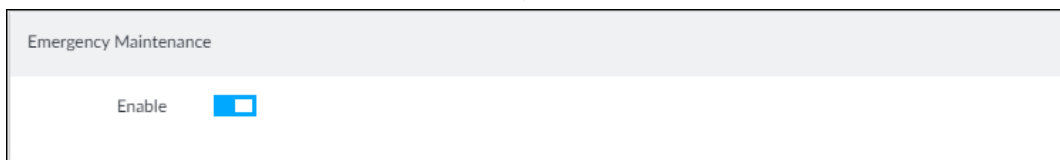

9.7.4 IMP/EXP

Export device configuration file to local PC or USB storage device, to backup it. When the configuration is lost due to abnormal operation, import the backup configuration file to restore system configurations quickly.

On the **LIVE** page, click **+**, and then select **MAINTAIN > Device Maintain > IMP/EXP**. The **IMP/EXP** page is displayed.

Figure 9-15 IMP/EXP



Exporting Configuration File

Click **Export** to export configuration file to local PC or USB storage device. File path might vary depending on your operations.

- On PCAPP, click , select **Download** to view file saving path.
- Select file saving path during local operation.



Connect USB device to the system if you are on the local menu to operate.

- During web operations, files are saved under default downloading path of the browser.

Importing Configuration File

Click **Browse** to select the configuration file, and then click **Import**. After the configuration file is imported successfully, the device will reboot automatically.

9.8 Disk Maintenance

Check the HDD status to handle exceptions in time.

9.8.1 S.M.A.R.T Detection

Run S.M.A.R.T detection to check HDD status.

Step 1 On the **LIVE** page, click , and select **MAINTAIN > Disk Maintain > S.M.A.R.T Detection**.

Figure 9-16 S.M.A.R.T detection

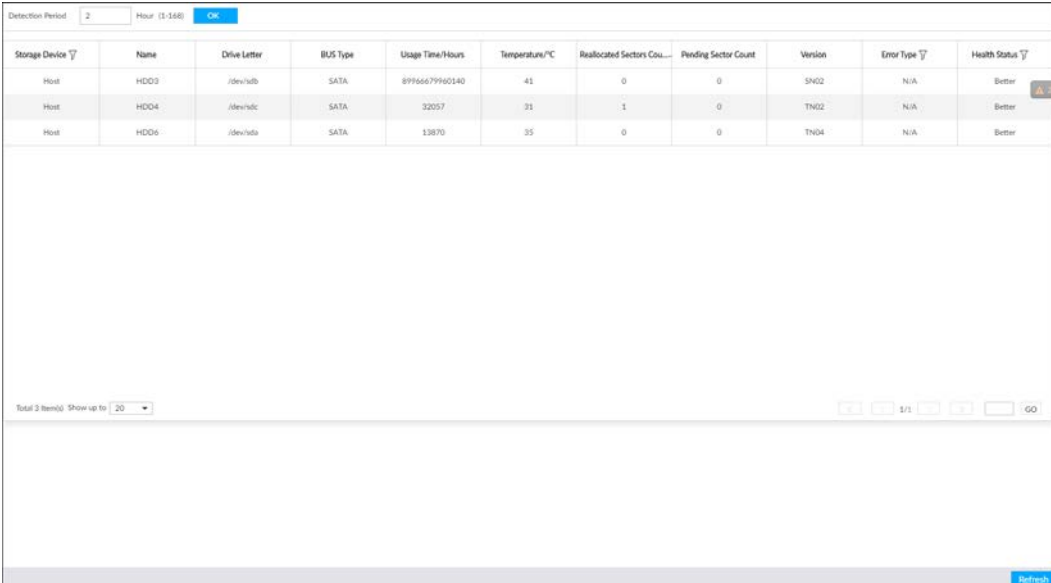

Storage Device	Name	Drive Letter	BUS Type	Usage Time/Hours	Temperature/°C	Reallocated Sectors Cou...	Pending Sector Count	Version	Error Type	Health Status
Host	HDD3	/dev/sdb	SATA	8996679960140	41	0	0	SN02	N/A	Better
Host	HDD4	/dev/sdc	SATA	32057	31	1	0	TN02	N/A	Better
Host	HDD6	/dev/sda	SATA	13870	35	0	0	TN04	N/A	Better

Total 3 item(s) Show up to 20

Refresh

Step 2 Set the detection period.

Step 3 Click **OK**.

9.8.2 SSD Health Detection

On the **LIVE** page, click , and select **MAINTAIN > Disk Maintain > SSD Health Detection**, and then you can view the storage allocation and remaining P/E cycle of SSD.

Figure 9-17 SSD health detection



9.8.3 Firmware Update

Import update file to update HDD information.

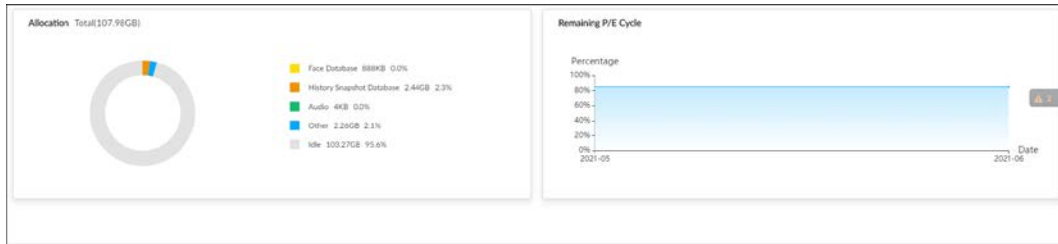
Step 1 On the **LIVE** page, click **+**, and select **MAINTAIN > Disk Maintain > Firmware Update**.

Figure 9-18 Firmware update

Storage Device	Name	Drive Letter	BUS Type	Model	Sn	Version	Latest Version	Upgrade State
Host	HDD3	/dev/sdb	SATA	ST6000NM0011S1VZ130		SN02	SN05	--
Host	HDD4	/dev/sdc	SATA	ST4000NM00331V4407		TN02	TN05	--
Host	HDD6	/dev/sda	SATA	ST4000NM00331V4407		TN04	TN05	--

Step 2 Click **Download Template** to download update template

Step 3 Click **Download**, and then open and fill in the downloaded template.

Step 4 Select an HDD, click **Import Firmware Info**, click **Browse** to choose the template to be imported, and then click **Import**.

Step 5 Click **Firmware Update** to update firmware information.

Step 6 Click **Detect Firmware** to refresh firmware information displayed on the page.

10 PCAPP Introduction

After installing PCAPP, system supports to access the Device remotely to carry out system configuration, function operations and system maintenance.



For details about installing PCAPP, see "5.3.1 Logging in to PCAPP Client".

10.1 Page Description









Double-click  on the PC desktop.

Figure 10-1 Task column



Table 10-1 Icons

Icons	Description
	Address bar: Enter the IP address of remote device.
	Enter device IP address and then click the button to go to the login page. Now the icon turns into  . Click to refresh the page.
	Click to view history login record, view downloads, set compatibility mode and view device version information.
	Click to minimize PCAPP.
	Click to maximize PCAPP.
	Click to display PCAPP at full screen.
	Click to close PCAPP.

10.2 History Record

Click , and then select **History**.

You can view history access record and clear buffer.

- Click **Clear History** to clear all history records.
- Click **Clear Buffer** to clear buffer data, and reboot PCAPP.

10.3 Viewing Downloads

To view and clear history downloads, click , and then select **Download**. The **Downloads** page is displayed.

- Double-click file name to open it.
- Click **Displayed in Folder** to open the folder where the file is located.

- Click **Clear Downloads** to clear history download records.

10.4 Configuring PCAPP

When PC theme is not Aero, video of PCAPP might not be displayed normally. It is suggested that PC theme should be switched to Aero, or compatibility mode of PCAPP should be enabled.

Switching PC Theme



This section uses Windows 7 as an example.

Right-click any blank position on PC desktop, select **Personalize**, and then switch to Aero theme. Restart PCAPP before the Aero theme takes effect.

Figure 10-2 PC theme

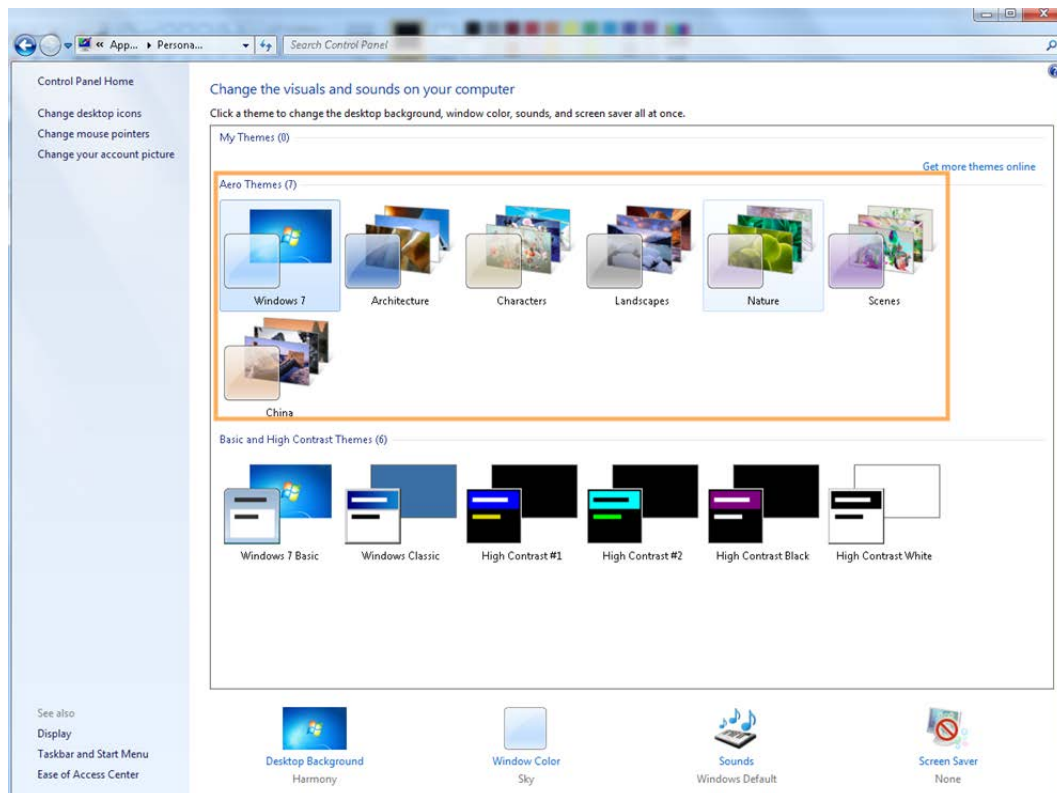

Setting Video and Picture Storage Path

Click **Browse** to specify the paths for saving videos and pictures. Only PCAPP supports this function.

Enabling Compatibility Mode

Click , and select **Settings**. The **Settings** page is displayed. Select **compatibility mode**. Restart PCAPP before the compatibility mode takes effect.

Figure 10-3 Setting



Enabling Hardware Acceleration

Click , and select **Settings**. Select **Enable hardware acceleration (it will take effect after video is opened again)**.

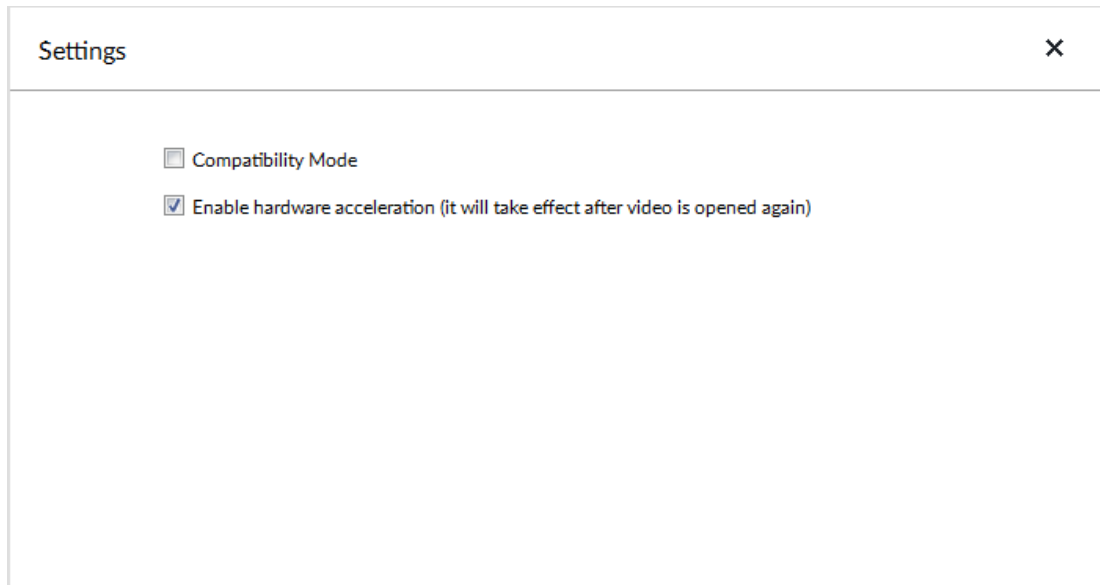
The live view becomes much more fluent when this function is enabled.

10.5 Viewing Version Details

Click , and then select **About** to view PCAPP version information.

11 Log Out, Reboot, Shut Down, Lock

Log out, reboot, shut down and lock out the Device.

Figure 11-1 User operation

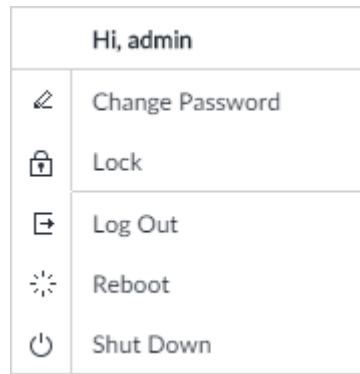

Logging Out

Click and then select **Log Out**.

Rebooting

Click and then select **Reboot**. System pops up confirm dialogue box. Click **OK** to reboot.

Shutting Down



To unplug the power cable might result in data (record and image) loss.

- Mode 1 (recommended): Click and then select **Shutdown**. System pops up confirm dialogue box and then click **OK** to shut down.
- Mode 2: Use power on-off button on the device.
 - ◇ 8-HDD series product: Press power on-off button on rear panel.
 - ◇ Other series products: Press the power on-off button on the device for at least 4 seconds.
- Mode 3: Unplug the power cable.

Locking

Click and then select **Lock** to lock the client. The locked client cannot be operated.

To unlock the client, click anywhere on the client, and then the **Unlock** dialogue box is displayed. Enter the username and password, and then click **OK**. You can also click **Switch User** to switch to another user account.

Figure 11-2 Unlock the client

Unlock ×

User Name

Password 

12 FAQ

Problem	Possibilities and Solutions
<p>After enabling AI by device function, there is no human face recognition event.</p>	<ul style="list-style-type: none"> ● The AI module is offline. Click + on the LIVE page, and select MAINTAIN > System Resources > AI Module Info. You can view status of the AI modules. ● There are too many filter criteria on the AI display page. ● The registered remote device does not support face detection function. ● Enable AI by device function. See "6.2.2 Configuring Face Detection" for detailed information. ● It is not in the deployment period. ● There is no linked face database or the face database has no data. ● The human face similarity setting is too high.
<p>After enabling AI by camera function, there is no human face recognition event.</p>	<ul style="list-style-type: none"> ● The human face recognition function has not been enabled on the AI plan. ● There is no human face database on the web interface of the remote device. ● It is not in the deployment period.
<p>There are no human face search results.</p>	<ul style="list-style-type: none"> ● The human face similarity setting is too high. ● The selected remote device does not trigger the human face recognition. ● There is no human face recognition on the search period. ● The specified human face image is not on the human face database.

Appendix 1 Glossary

Name	Description
CGI	Common Gateway Interface (CGI) is an important Internet technology. With CGI, client can ask data from program running on network server. CGI describes data transmission standard between server and asking processing program.
DDNS	Dynamic Domain Name System (DDNS) is to map the user dynamic IP address to a specified domain analysis service. Each time, when the user connects to the network, the client can transmit the host dynamic address to the server application on the host of the service provider. The server applications are to provide the DNS service and realize dynamic domain analysis. That is to say, the user does not need to remember the changeable IP address, just uses the domain name to login the device or the address.
DHCP	Dynamic Host Configuration Protocol (DHCP) is a network protocol in the LAN. It is to automatically allocate IP address for the internal network or the ISP (Internet service provider).It is to manage the computer IP address by the unified means of management.
DNS	Domain Name System (DNS) is to save the all host domain name and corresponding IP address in the network. It has the ability to change the domain to the IP address.
DVR	Digital Video Recorder.
FTP	File Transfer Protocol (FTP) is used to control bilateral transmission of file on the Internet.
HDMI	High Definition Multimedia Interface (HDMI) is a special digital interface suitable for audio/video transmission. It can transmit audio signal and video signal at the same time.
HTTPS	Hyper Text Transfer Protocol over Secure Socket Layer (HTTPS) is a HTTP channel for security purpose. The HTTPS has defined the browser the world wide web service safety communication rule. It adopts encryption technology to guaranty safety access to the webpage.
IP	Internet Protocol.
IPC	IP Camera.
NTP	Network Time Protocol (NTP) is a protocol to synchronize computer time. It adopts wireless network protocol UDP, so that the computer time synchronizes with the server or the time source. It is to provide time correction of high accuracy.
NTSC	National Television Standards Committee, American national standard television and broadcast transmission and receiving protocol. This is a television standard that television scanning beam is 525 beams, 30 frames per second, interlaced scanning, odd field first and then it is followed by even field. NTSC is used in the United States of America, Japan, and so on.
NVR	Network Video Recorder
MTU	Maximum Transmission Unit (MTU) refers to the maximum data packet amount (byte) on one layer of the communication protocol.

Name	Description
ONVIF	Open Network Video Interface Forum (ONVIF) is the defined general protocol for information exchange among the network video devices. It includes search device, real-time audio/video, metadata, information control, and so on.
PAL	Phase Alteration Line, this is a television standard that television scanning beam is 625 beams, 25 frames per second, phase alteration, odd field first and then it is followed by even field. PAL color encoding is used. PAL is used in China, Europe, and so on.
PTZ	Pan Tilt Zoom (PTZ) refers to the PTZ all-direction movement, lens zoom, and focus control.
RAID	RAID is an abbreviation for Redundant Array of Independent Disks. It is to combine several independent HDDs (physical HDD) to form a HDD group (logic HDD), to provide higher storage performance and data redundancy.
S.M.A.R.T	Self-Monitoring Analysis and Reporting Technology (S.M.A.R.T) is a technical standard to detect HDD drive status and report potential problems.
SSH	Secure Shell (SSH) is a security protocol formulated by IETF network group on the basis of application layer. SSH protocol can effectively prevent information leakage problem during remote management.
SVC	Scalable Video Coding (SVC) is a video encoding technology. It can split the video streams to one basic layer and several enhanced layers according to the requirements. The basic layer provides the general video quality, frame rate and resolution, and the enhanced layer is to perfect the video quality.
VGA	Video Graphics Array (VGA) is a video transmission standard. It has high resolution, high display speed and abundant colors.
WLAN	Wireless Local Area Networks (WLAN) adopts radio frequency to realize data transmission.

Appendix 2 Mouse and Keyboard Operations

This section introduces mouse and keyboard operations.

Appendix 2.1 Mouse Operations

Connect mouse to the USB port, you can use the mouse to control the local menu. For details, see the following table.

Appendix Table 2-1 Mouse operations

Operation	Description
Click (click the left mouse button)	<p>Click to select a function menu, to enter the corresponding menu page.</p> <ul style="list-style-type: none"> • Implement the operation indicated on the control. • Change checkbox and option button status. • Click the checkbox to display drop-down list. • On virtual keyboard, select letter, symbol, English upper letter and lower letter, and Chinese characters.
Double-click (click the left mouse button twice)	<ul style="list-style-type: none"> • On the LIVE page, double-click one video window to zoom in the window. Click any position out of the window, so the video window restores original size. • On the LIVE page, double-click the remote device in the device tree. Switch to video edit status, and add remote device. • Double-click the image or record file thumbnail, to playback record file or view the image.
Right-click (click the right mouse button)	<ul style="list-style-type: none"> • On the LIVE or SEARCH page, right-click one video window to display the shortcut menu. • On the LIVE page, right-click the view in the list or the remote device in the device tree, to display the shortcut menu.
Wheel button	<ul style="list-style-type: none"> • On the SEARCH page, mpoint to the time bar, and then click the mouse wheel, to adjust the accurate time on the time bar. • Click the control that needs to input number (such as input date or time). Roll the mouse wheel to adjust the number value.
Drag the mouse	<ul style="list-style-type: none"> • Drag the mouse pointer to select the motion detect zone. • On the LIVE page, drag the remote device in the device tree to the play window, switch to the view status. It is to add the remote device. • On the SEARCH page, drag the record file or the image thumbnail to the playback window. It is to play back the corresponding record file or image.

Appendix 2.2 Virtual Keyboard

The local menu supports virtual keyboard.

Click the text box to display virtual keyboard. For details, see the following pictures and table.



If the device has connected to the peripheral keyboard, click the text column. Virtual keyboard will disappear.

Appendix Figure 2-1 Virtual keyboard (global keyboard)

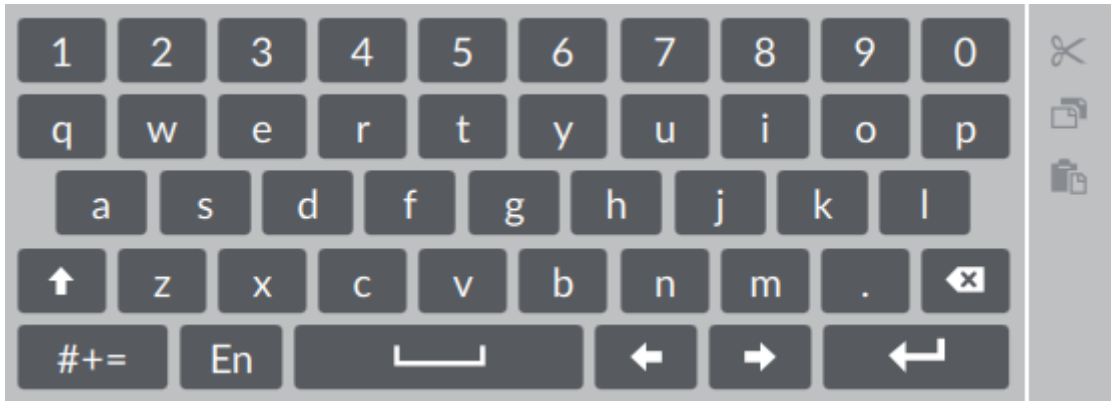

Appendix Figure 2-2 Virtual keyboard (digital keyboard)













Appendix Figure 2-3 Virtual keyboard (input letter)



Appendix Table 2-2 Virtual keyboard icon

Signal Words	Description
	Click the icon to switch to upper case. The icon becomes . Click to switch to lower case.

Signal Words	Description
	Click to delete letter.
	Click to input letter. Now the icon turns into  . Click  to restore previous input mode.
	Click to input space.
	Click to control cursor position.
	Click to switch to the next line.
	Select text and click the icon to cut the selected contents.
	Select text and click the icon to copy the selected contents.
	Cut or copy the contents, click the text box and click the icon to paste the contents.

Appendix 3 RAID

RAID is an abbreviation for Redundant Array of Independent Disks. It is to combine several independent HDDs (physical HDD) to form a HDD group (logic HDD).

Comparing with one HDD, RAID provides more storage capacity and data redundancy. The different redundant arrays have different RAID level. Each RAID level has its own data protection, data availability and performance degree.

RAID Level

RAID Level	Description	Min. HDD Needed
RAID0	RAID 0 is called striping. RAID 0 is to save the continued data fragmentation on several HDDs. It can process the read and write at the same time, so its read/write speed is N (N refers to the HDD amount of the RAID 0) times as many as one HDD. RAID 0 does not have data redundant, so one HDD damage might result in data loss that cannot be restored.	2
RAID1	It is also called mirror or mirroring. RAID 1 data is written to two HDDs equally, which guarantee the system reliability and can be repaired. RAID 1 read speed is almost close to the total volume of all HDDs. The write speed is limited by the slowest HDD. At the same time, the RAID 1 has the lowest HDD usage rate. It is only 50%.	
RAID5	RAID5 is to save the data and the corresponding odd/even verification information to each HDD of the RAID5 group and save the verification information and corresponding data to different HDDs. When one HDD of the RAID5 is damaged, system can use the rest data and corresponding verification information to restore the damaged data. It does not affect data integrity.	3
RAID6	Based on the RAID5, RAID6 adds one odd/even verification HDD. The two independent odd/even systems adopt different algorithm, the data reliability is very high. Even two HDDs are broken at the same time, there is no data loss risk. Comparing to RAID5, the RAID6 needs to allocate larger HDD space for odd/even verification information, so its read/write is even worse.	4

RAID Level	Description	Min. HDD Needed
RAID10	RAID 10 is a combination of the RAID 1 and RAID 0. It uses the extra high speed efficient of the RAID 0 and high data protection and restores capability of the RAID 1. It has high read/write performance and security. However, the RAID 10 HDD usage efficiency is as low as RAID 1.	
RAID50	RAID50 is a combination of the RAID5 and RAID0. It has higher fault-tolerance. There is no data loss even one HDD in the set malfunctions.	6
RAID60	RAID60 is a combination of the RAID6 and RAID0. It has higher fault-tolerance and read performance. There is no data loss even two HDDs in one set malfunctions.	8

RAID Capacity

See the sheet for RAID space information.

Capacity N refers to the mini HDD amount to create the corresponding RAID.

RAID Level	Total Space of the N HDD
RAID0	The total amount of current RAID group
RAID1	Min (capacity N)
RAID5	$(N-1) \times \text{min (capacity N)}$
RAID6	$(N-2) \times \text{min (capacity N)}$
RAID10	$(N/2) \times \text{min (capacity N)}$
RAID50	$(N-2) \times \text{min (capacity N)}$
RAID60	$(N-4) \times \text{min (capacity N)}$

Appendix 4 HDD Capacity Calculation

HDD capacity calculation formula:

Total capacity (M) = Channel number × Demand time length (hour) × HDD capacity occupied per hour (M/hour)

According to the above formula, get recording time calculation formula.

Recording time (hour) =

$$\frac{\text{Total capacity (M)}}{\text{HDD capacity occupied per hour (M/hour)} \times \text{Channel number}}$$

For example, for single-channel recording, HDD capacity occupied per hour is 200 M/hour. Use 4-channel device to make 24-hour continuous recording in every day of one month (30 days), the required HDD space is: 4 channels × 30 days × 24 hours × 200 M/hour = 576 G. Therefore, five 120 G HDD or four 160 G HDD shall be installed.

According to the above formula, at different stream values, recording file size of 1 channel in 1 hour is shown as follows (for your reference):

Appendix Table 4-1 HDD capacity calculation

Bit stream Size (max.)	File Size	Bit Stream Size (max.)	File Size
≤ 96 K	42 M	128 K	56 M
160 K	70 M	192 K	84 M
224 K	98 M	256 K	112 M
320 K	140 M	384 K	168 M
448 K	196 M	512 K	225 M
640 K	281 M	768 K	337 M
896 K	393 M	1024 K	450 M
1280 K	562 M	1536 K	675 M
1792 K	787 M	2048 K	900 M

Appendix 5 Particulate and Gaseous Contamination Specifications

Appendix 5.1 Particulate Contamination Specifications

The following table defines the limitations of the particulate contamination in the operating environment of the device. If the level of particulate contamination exceeds the specified limitations and result in device damage or failure, you need to rectify the environmental conditions.

Appendix Table 5-1 Particulate contamination specifications

Particulate contamination	Specifications
Air filtration	Class 8 as defined by ISO 14644-1.
Conductive dust	Air must be free of conductive dust, zinc whiskers, or other conductive particles.
Corrosive dust	Air must be free of corrosive dust. Residual dust present in the air must have a deliquescent point less than 60% relative humidity.

Appendix Table 5-2 ISO 14644-1 cleanroom classification

Class	Maximum particles/m ³					
	≥ 0.1 μm	≥ 0.2 μm	≥ 0.3 μm	≥ 0.5 μm	≥ 1 μm	≥ 5 μm
—	—	—	—	—	—	—
Class 1	10	2	—	—	—	—
Class 2	100	24	10	4	—	—
Class 3	1000	237	102	35	8	—7
Class 4	10000	2370	1020	352	83	—
Class 5	100000	23700	10200	3520	832	29
Class 6	1000000	237000	102000	35200	8320	293
Class 7	—	—	—	352000	83200	2930
Class 8	—	—	—	3520000	832000	29300
Class 9	—	—	—	—	8320000	293000

Appendix 5.2 Gaseous Contamination Specifications

Usually indoor and outdoor atmospheric environments contain a small amount of common corrosive gas pollutants. When these mixed or single corrosive gas pollutants react with other environmental factors such as temperature or relative humidity in the long term, the device might suffer from a risk of corrosion and failure. The following table defines the limitations of the gaseous contamination in the operating environment of the device.

Appendix Table 5-3 Gaseous contamination specifications

Gaseous contamination	Specifications
Copper coupon corrosion rate	< 300 Å/month per Class G1 as defined by ANSI/ISA71.04-2013
Silver coupon corrosion rate	< 200 Å/month per Class G1 as defined by ANSI/ISA71.04-2013

Appendix Table 5-4 ANSI/ISA-71.04-2013 classification of reactive environments

Class	Copper Reactivity	Silver Reactivity	Description
G1 (mild)	< 300 Å/month	< 200 Å/month	Corrosion is not a factor in determining equipment reliability.
G2 (moderate)	< 1000 Å/month	< 1000 Å/month	Corrosion effects are measurable and corrosion might be a factor.
G3 (harsh)	< 2000 Å/month	< 2000 Å/month	High probability that corrosive attack will occur.
GX (severe)	≥ 2000 Å/month	≥ 2000 Å/month	Only specially designed and packaged devices are expected to survive.

Appendix 6 Cybersecurity Recommendations

Cybersecurity is more than just a buzzword: it's something that pertains to every device that is connected to the internet. IP video surveillance is not immune to cyber risks, but taking basic steps toward protecting and strengthening networks and networked appliances will make them less susceptible to attacks. Below are some tips and recommendations from Dahua on how to create a more secured security system.

Mandatory actions to be taken for basic device network security:

1. Use Strong Passwords

Please refer to the following suggestions to set passwords:

- The length should not be less than 8 characters.
- Include at least two types of characters; character types include upper and lower case letters, numbers and symbols.
- Do not contain the account name or the account name in reverse order.
- Do not use continuous characters, such as 123, abc, etc.
- Do not use overlapped characters, such as 111, aaa, etc.

2. Update Firmware and Client Software in Time

- According to the standard procedure in Tech-industry, we recommend to keep your device (such as NVR, DVR, IP camera, etc.) firmware up-to-date to ensure the system is equipped with the latest security patches and fixes. When the device is connected to the public network, it is recommended to enable the "auto-check for updates" function to obtain timely information of firmware updates released by the manufacturer.
- We suggest that you download and use the latest version of client software.

"Nice to have" recommendations to improve your device network security:

1. Physical Protection

We suggest that you perform physical protection to device, especially storage devices. For example, place the device in a special computer room and cabinet, and implement well-done access control permission and key management to prevent unauthorized personnel from carrying out physical contacts such as damaging hardware, unauthorized connection of removable device (such as USB flash disk, serial port), etc.

2. Change Passwords Regularly

We suggest that you change passwords regularly to reduce the risk of being guessed or cracked.

3. Set and Update Passwords Reset Information Timely

The device supports password reset function. Please set up related information for password reset in time, including the end user's mailbox and password protection questions. If the information changes, please modify it in time. When setting password protection questions, it is suggested not to use those that can be easily guessed.

4. Enable Account Lock

The account lock feature is enabled by default, and we recommend you to keep it on to guarantee the account security. If an attacker attempts to log in with the wrong password several times, the corresponding account and the source IP address will be locked.

5. Change Default HTTP and Other Service Ports

We suggest you to change default HTTP and other service ports into any set of numbers between 1024–65535, reducing the risk of outsiders being able to guess which ports you are using.

6. **Enable HTTPS**

We suggest you to enable HTTPS, so that you visit Web service through a secure communication channel.

7. **MAC Address Binding**

We recommend you to bind the IP and MAC address of the gateway to the device, thus reducing the risk of ARP spoofing.

8. **Assign Accounts and Privileges Reasonably**

According to business and management requirements, reasonably add users and assign a minimum set of permissions to them.

9. **Disable Unnecessary Services and Choose Secure Modes**

If not needed, it is recommended to turn off some services such as SNMP, SMTP, UPnP, etc., to reduce risks.

If necessary, it is highly recommended that you use safe modes, including but not limited to the following services:

- SNMP: Choose SNMP v3, and set up strong encryption passwords and authentication passwords.
- SMTP: Choose TLS to access mailbox server.
- FTP: Choose SFTP, and set up strong passwords.
- AP hotspot: Choose WPA2-PSK encryption mode, and set up strong passwords.

10. **Audio and Video Encrypted Transmission**

If your audio and video data contents are very important or sensitive, we recommend that you use encrypted transmission function, to reduce the risk of audio and video data being stolen during transmission.

Reminder: encrypted transmission will cause some loss in transmission efficiency.

11. **Secure Auditing**

- Check online users: we suggest that you check online users regularly to see if the device is logged in without authorization.
- Check device log: By viewing the logs, you can know the IP addresses that were used to log in to your devices and their key operations.

12. **Network Log**

Due to the limited storage capacity of the device, the stored log is limited. If you need to save the log for a long time, it is recommended that you enable the network log function to ensure that the critical logs are synchronized to the network log server for tracing.

13. **Construct a Safe Network Environment**

In order to better ensure the safety of device and reduce potential cyber risks, we recommend:

- Disable the port mapping function of the router to avoid direct access to the intranet devices from external network.
- The network should be partitioned and isolated according to the actual network needs. If there are no communication requirements between two sub networks, it is suggested to use VLAN, network GAP and other technologies to partition the network, so as to achieve the network isolation effect.
- Establish the 802.1x access authentication system to reduce the risk of unauthorized access to private networks.

- Enable IP/MAC address filtering function to limit the range of hosts allowed to access the device.

More information

Please visit Dahua official website security emergency response center for security announcements and the latest security recommendations.

ENABLING A SAFER SOCIETY AND SMARTER LIVING

ZHEJIANG DAHUA VISION TECHNOLOGY CO., LTD.

Address: No.1199 Bin'an Road, Binjiang District, Hangzhou, P. R. China | Website: www.dahuasecurity.com | Postcode: 310053

Email: overseas@dahuatech.com | Fax: +86-571-87688815 | Tel: +86-571-87688883