

WISENET

In-ceiling Housing

Installation Manual

SHP-1680F(IVORY)
SHP-1680FW(WHITE)



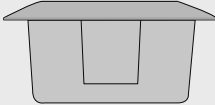

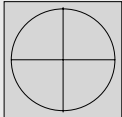

TABLE OF CONTENTS

Overview	3
What's Included	3
Installation Instructions	4
How to install (XNP-6120/HCP-6120 SERIES).....	4
How to install (XNV-6120 SERIES/XNV-6085 SERIES)	9
How to install (XND-6085/XND-6085V SERIES)	14
Product Specifications	18

OVERVIEW

This In-CEILING HOUSING is a mounting ADAPTOR that is designed to mount the smart dome camera in built-in style on a double-layer ceiling.

WHAT'S INCLUDED

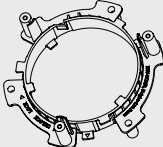
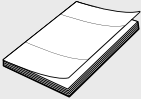
		
HOUSING	SAFETY BRACKET (1EA)	SAFETY WIRE (1SET)
		
TEMPLATE (1EA)	SCREW (3EA)	LOWER BRACKET (for XNV-6120/XNV-6085/ XND-6085/XND-6085V) (1EA)
		
INSTALLATION MANUAL		

INSTALLATION INSTRUCTIONS

1. Select an installation position or place that can endure more than 4 times of the total weight of the installation structure.
2. At least 250mm or more of spare height is required above the **CEILING BOARD**.
3. **CEILING BOARD**'s thickness should be less than 40mm.
4. Be sure to secure the SAFETY WIRE to avoid a product fall.
5. If you want to attach the camera to the ADAPTOR, use the only provided SCREWS.

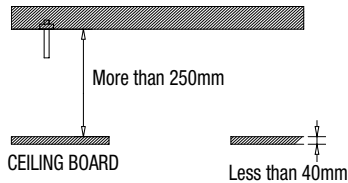

HOW TO INSTALL (XNP-6120/HCP-6120 SERIES)

1. Place the **TEMPLATE** on the **CEILING BOARD** and drill a guided hole.
 - 1 Remove the round filling ("C") from the **TEMPLATE**.
 - 2 Place **TEMPLATE A** onto the **CEILING BOARD** to which you will attach the ceiling mount ADAPTOR and drill a hole of $\varnothing 213\text{mm}$ in diameter.See the figure below for the hole shape.

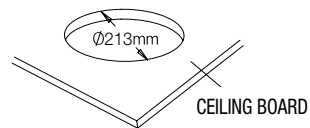
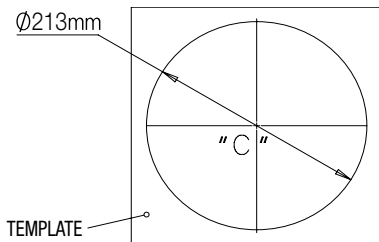

2. Fix the **ANCHOR BOLT** onto the concrete **CEILING**, and secure the **SAFETY WIRE** to the **ANCHOR BOLT** as below:

- ① Tighten the nut ("N1") on the **ANCHOR BOLT**.
- ② Insert the provided **SAFETY BRACKET** into the **ANCHOR BOLT**.
- ③ Tighten two nuts ("N2","N3") onto the **ANCHOR BOLT**.
- ④ Hook and fix one end of the **SAFETY WIRE** onto the **SAFETY BRACKET**.
- ⑤ Hook and fix the other end of **SAFETY WIRE** onto the **HOUSING** as shown below.

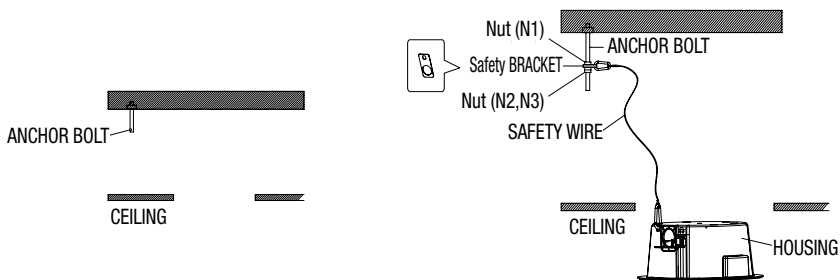

※ The ANCHOR BOLTS and nuts are optional and not included in the product package.

3. To connect to the camera, insert the external cable through the side **hole** on the **housing** to the inside of the **housing** as shown in the figure.



- Refer to the installation manual of the camera that you want to install, and prepare necessary cables for camera connection.

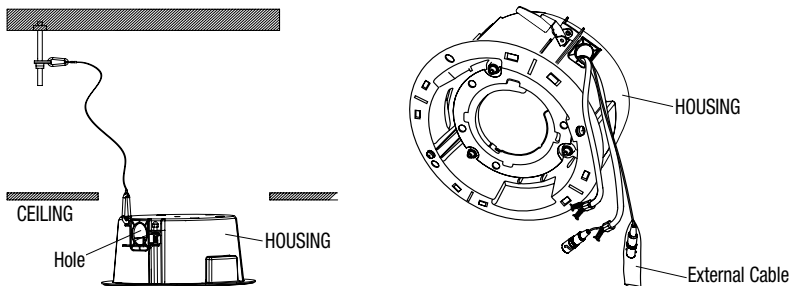

4. Push the **HOUSING** inside the **CEILING** through the **CEILING** hole, and tighten the **SCREWS** (x2) clockwise to fix the **HOUSING** on the **CEILING**.
(The **BRACKET** will be positioned from <A> to as shown.)

- Ensure that the **HOUSING** is firmly secured to the **CEILING BOARD**.

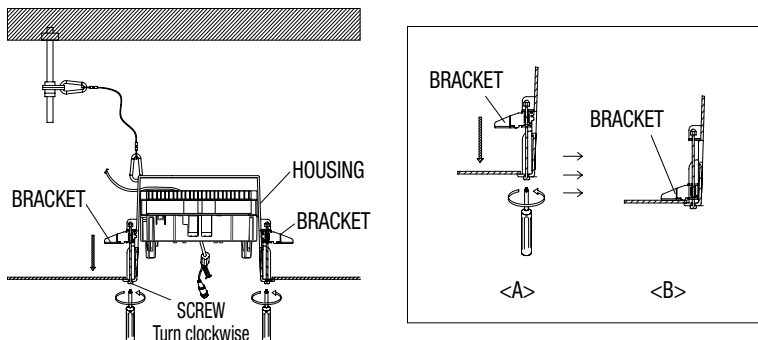

5. Remove the dome cover after loosening the three bolts by turning them counterclockwise using an L wrench.

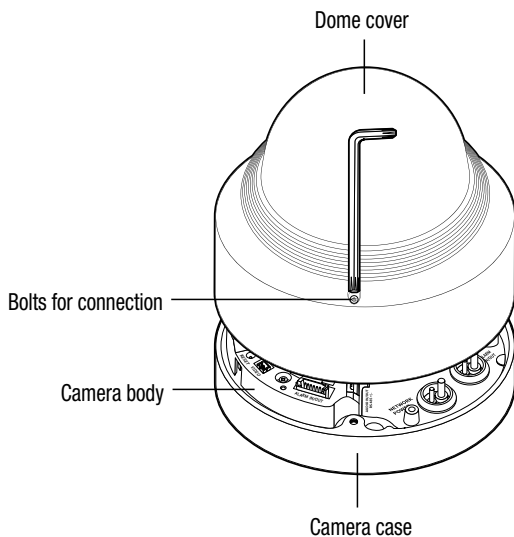

6. Remove the safety wire that is connected to the dome cover and camera body, and connect it inside of the dome cover as shown in the picture.

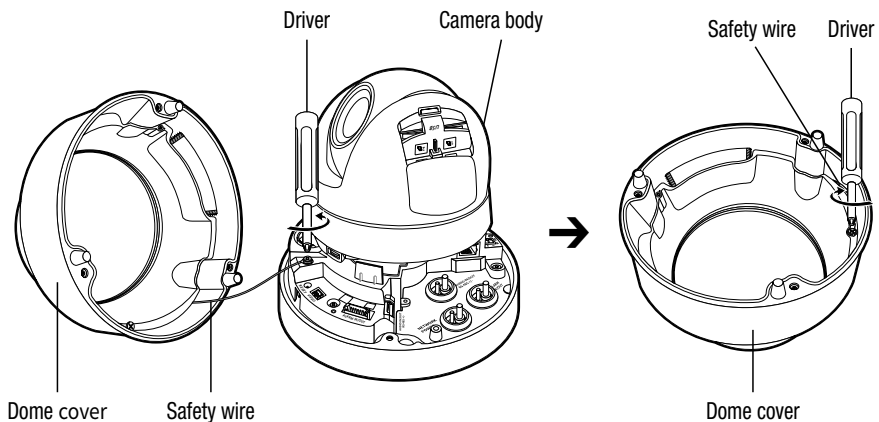

7. Connect the required cable to the terminal on the camera. Please refer to the installation guide for details on camera installation.

- ! ■ Connect and organize the cable to ensure that it is not damaged or trapped when the PTZ rotation part is rotated.

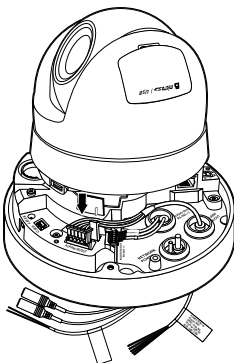

8. Connect the camera to the bracket placed in the housing using the screws (3 EA).
* Reconnect the cover by turning the three bolts on the dome cover clockwise using the L wrench.

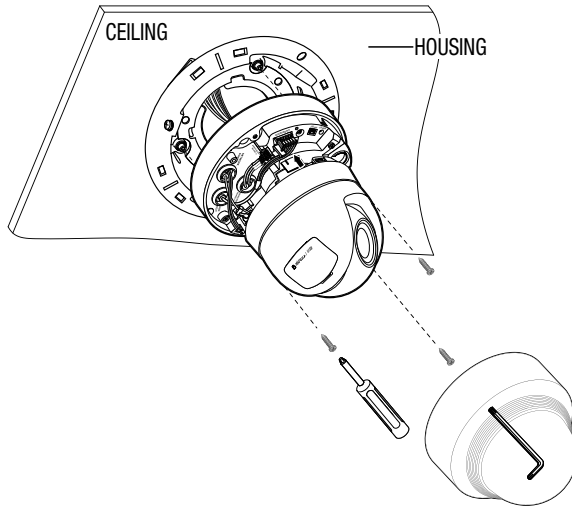

9. Attach the **COVER** to the **HOUSING**.

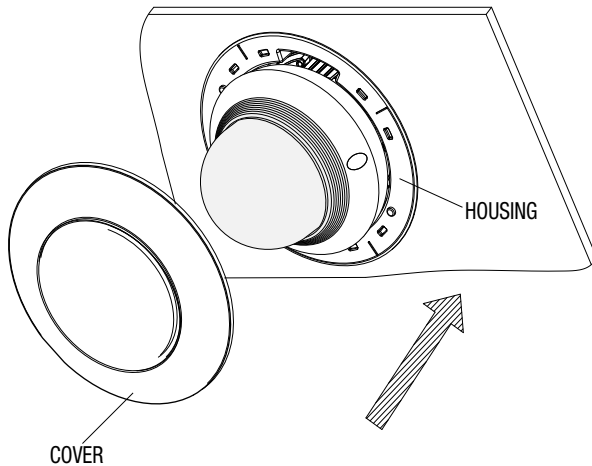

HOW TO INSTALL (XNV-6120 SERIES/ XNV-6085 SERIES)

1. Place the **TEMPLATE** on the **CEILING BOARD** and drill a guided hole.

- ① Remove the round filling ("C") from the **TEMPLATE**.
- ② Place the **TEMPLATE** A onto the **CEILING BOARD** to which you will attach the **CEILING** mount ADAPTOR and drill a $\varnothing 213\text{mm}$ hole.

See the figure below for the hole shape.

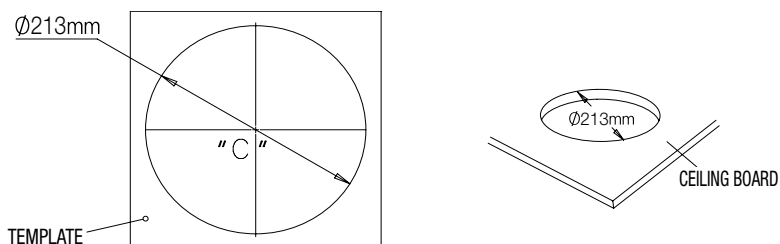

2. Insert the lower bracket into the housing and turn it in the **[LOCK]** direction to fix it.

- ✘ Check the model name in the lower bracket and mount it on the surface corresponding to the model.
- ✘ If the LOCKING structure is locked in as shown in the image, it is fixed.

- ! Be sure to check whether LOCKING is in normal state and not being rotated in the opposite direction.

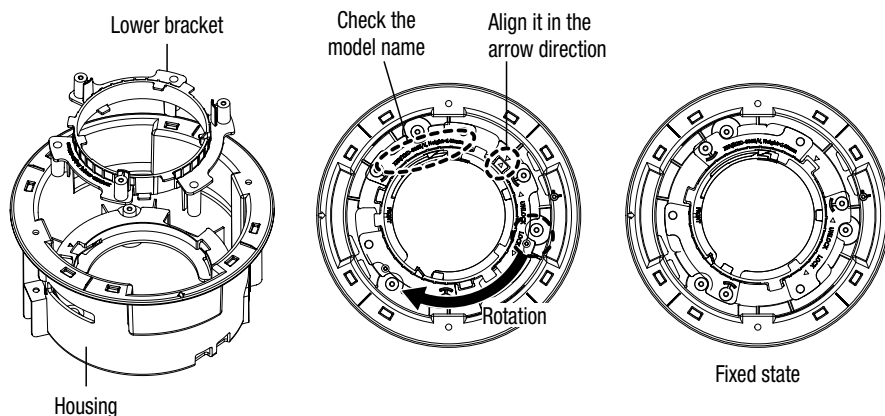

3. Fix the **ANCHOR BOLT** onto the concrete **CEILING**, and secure the **SAFETY WIRE** to the **ANCHOR BOLT** as below:

- ① Tighten the **NUT** ("N1") on the **ANCHOR BOLT**.
- ② Insert the provided **SAFETY BRACKET** into the **ANCHOR BOLT**.
- ③ Tighten two **NUTS** ("N2", "N3") onto the **ANCHOR BOLT**.
- ④ Hook and fix one end of the **SAFETY WIRE** onto the **SAFETY BRACKET**.
- ⑤ Hook and fix the other end of **SAFETY WIRE** onto the **HOUSING** as shown below:

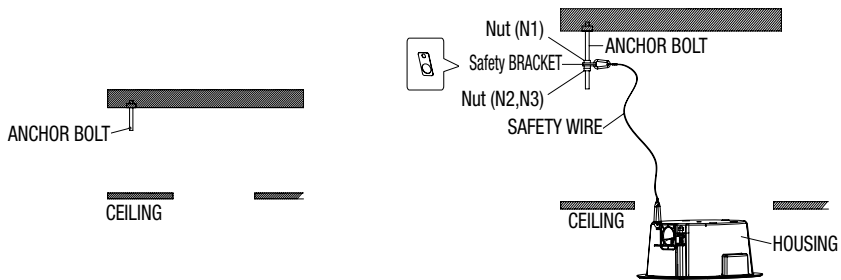

× The **ANCHOR BOLTS** and nuts are optional and not included in the product package.

4. To connect to the camera, insert the external cable through the side **hole** on the **housing** to the inside of the **housing** as shown in the figure.



- Refer to the installation manual of the camera that you want to install, and prepare necessary cables for camera connection.

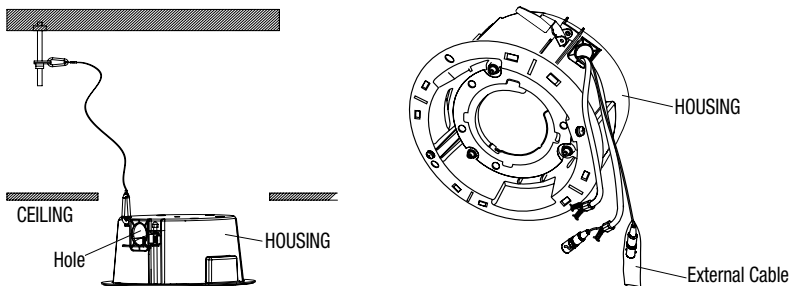

5. Push the **HOUSING** inside the **CEILING** through the **CEILING** hole, and tighten the **SCREWS** (x2) clockwise to fix the **HOUSING** on the **CEILING**.
(The **BRACKET** will be positioned from <A> to as shown.)



- Ensure that the **HOUSING** is firmly secured to the **CEILING BOARD**.

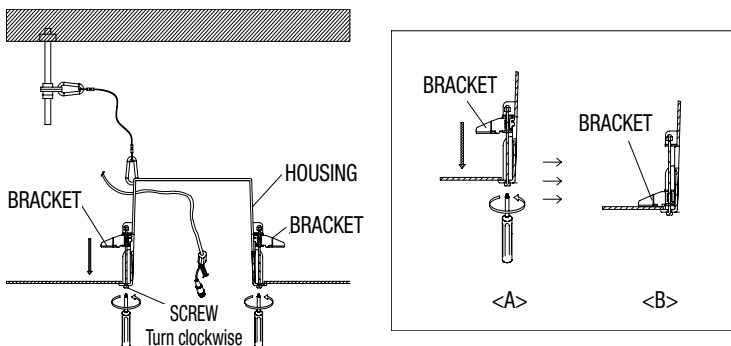

6. As shown in the figure, pull out the protrusions of the rubber cap in the bottom to make a small hole and remove the cable through it to connect to the external cable.

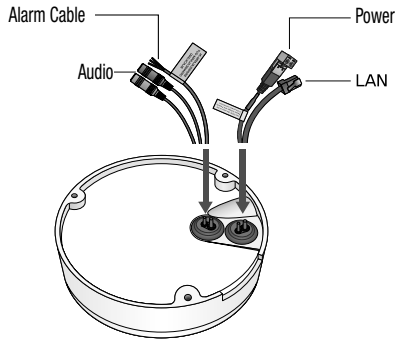

- If waterproofing in the connected cable jacket is poor, it may cause leaks. Make sure you tape it tight and thoroughly.
- The butyl rubber tape for waterproofing can extend at least twice as long as the original length.

7. Connect the camera to the bracket placed in the housing using the screws (3 EA).
* Reconnect the cover by turning the three bolts on the dome cover clockwise using the L wrench.

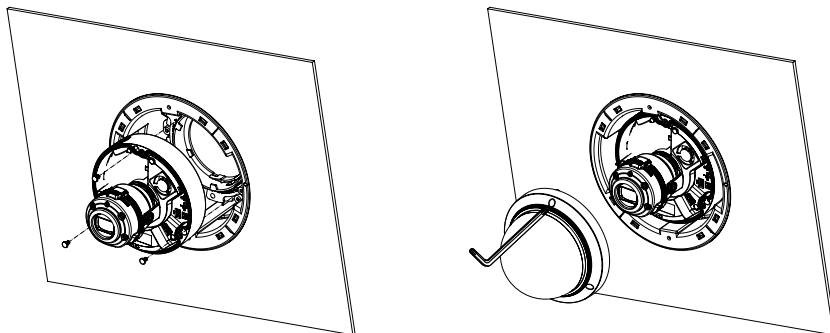

8. Attach the **COVER** to the **HOUSING**.

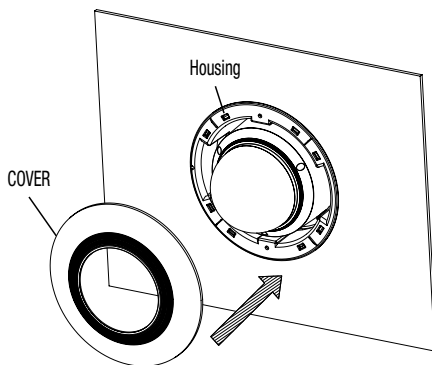

HOW TO INSTALL (XND-6085/XND-6085V SERIES)

1. Place the **TEMPLATE** on the **CEILING BOARD** and drill a guided hole.
 - 1 Remove the round filling ("C") from the **TEMPLATE**.
 - 2 Place the **TEMPLATE A** onto the **CEILING BOARD** to which you will attach the **CEILING** mount ADAPTOR and drill a $\varnothing 213\text{mm}$ hole.See the figure below for the hole shape.

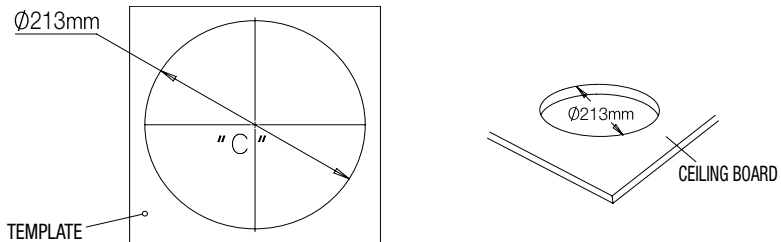

2. Insert the lower bracket into the housing and turn it in the **[LOCK]** direction to fix it.
 - × Check the model name in the lower bracket and mount it on the surface corresponding to the model.
 - × If the **LOCKING** structure is locked in as shown in the image, it is fixed.

! Be sure to check whether **LOCKING** is in normal state and not being rotated in the opposite direction.

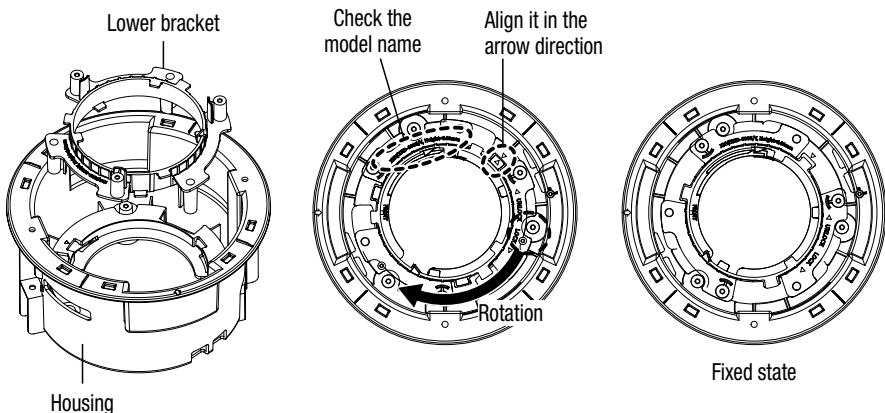

3. Fix the **ANCHOR BOLT** onto the concrete **CEILING**, and secure the **SAFETY WIRE** to the **ANCHOR BOLT** as below:
 - ① Tighten the **NUT** ("N1") on the **ANCHOR BOLT**.
 - ② Insert the provided **SAFETY BRACKET** into the **ANCHOR BOLT**.
 - ③ Tighten two **NUTS** ("N2", "N3") onto the **ANCHOR BOLT**.
 - ④ Hook and fix one end of the **SAFETY WIRE** onto the **SAFETY BRACKET**.
 - ⑤ Hook and fix the other end of **SAFETY WIRE** onto the **HOUSING** as shown below:

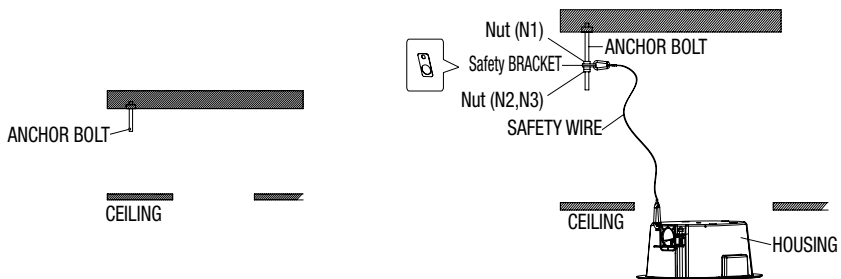

× The **ANCHOR BOLTS** and nuts are optional and not included in the product package.

4. To connect to the camera, insert the external cable through the side **hole** on the **housing** to the inside of the **housing** as shown in the figure.

- Refer to the installation manual of the camera that you want to install, and prepare necessary cables for camera connection.

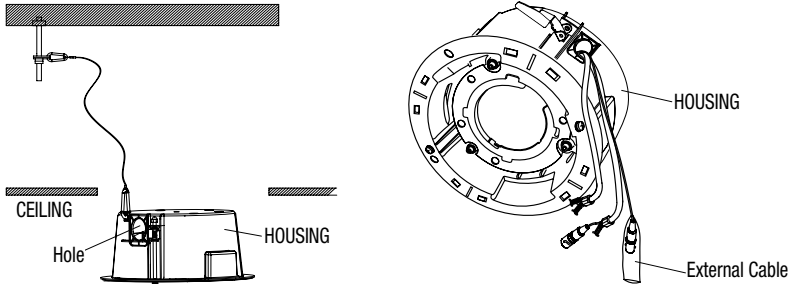

5. Push the **HOUSING** inside the CEILING through the CEILING hole, and tighten the **SCREWS** (x2) clockwise to fix the **HOUSING** on the **CEILING**.
(The **BRACKET** will be positioned from <A> to as shown.)

- Ensure that the **HOUSING** is firmly secured to the **CEILING BOARD**.

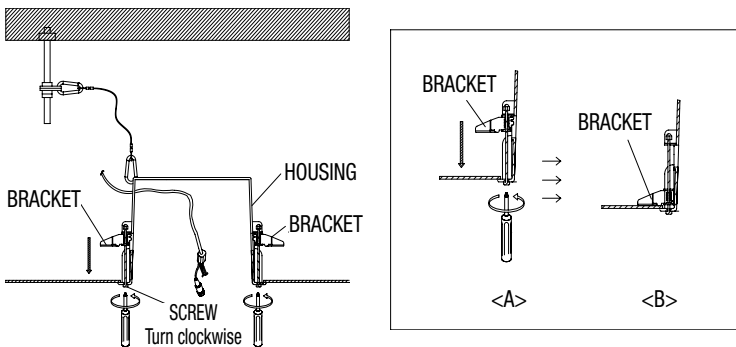

6. Connect the camera to the bracket placed in the housing using the screws (3 EA).
 - × Reconnect the cover by turning the three bolts on the dome cover clockwise using the L wrench.

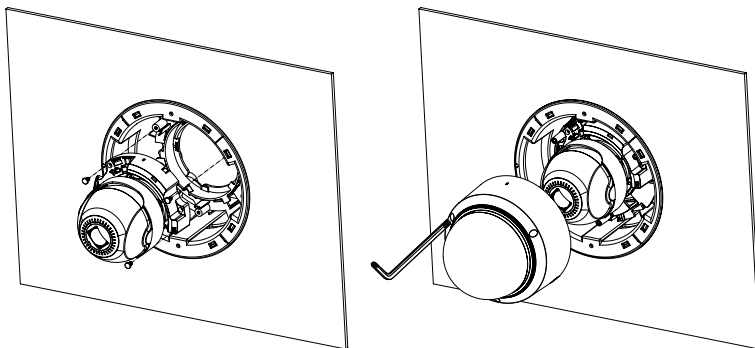

× In case of XND-6085, it can be assembled by pushing it without using bolts.

7. Attach the **COVER** to the **HOUSING**.

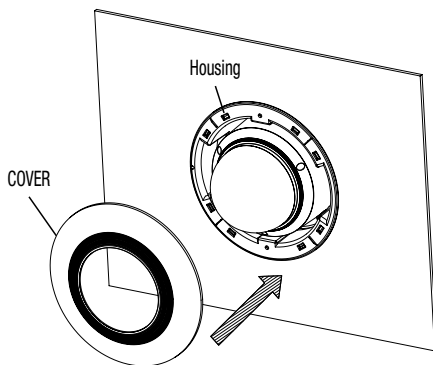

PRODUCT SPECIFICATIONS

Item	Specifications
Dimension (mm)	D232 X H135.5
Weight	605g
Temperature	-10°C ~ 55°C
Material	PC
Color	SHP-1680F : IVORY SHP-1680FW : WHITE

Unit : mm (Inches)

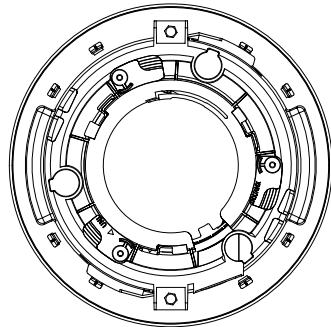
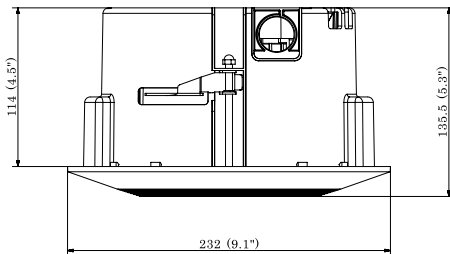

Head Office

6, Pangyo-ro 319 beon-gil, Bundang-gu, Seongnam-si,
Gyeonggi-do, 463-400 Rep. of KOREA
Tel : +82.70.7147.8753 Fax : +82.31.8018.3740
www.hanwha-security.com

Hanwha Techwin America

500 Frank W. Burr Blvd. Suite 43 Teaneck, NJ 07666
Toll Free +1.877.213.1222 Direct +1.201.325.6920
Fax +1.201.373.0124
www.hanwhasecurity.com

Hanwha Techwin Europe

Heriot House, Heriot Road, Chertsey, Surrey, KT16 9DT, United Kingdom
Tel +44.1932.57.8100 Fax +44.1932.57.8101
www.hanwha-security.eu
