

WISENET

In-ceiling Housing

Installation Manual

SHP-3701F

CE

TABLE OF CONTENTS

Overview 3

What's Included 3

Installation Instructions 4

Installation (SCP-3430 Series) 4

Installation (SCP-3370/SNP-5200 SERIES) 9







Installation (SCP-3371/SNP-5300 SERIES) 13

Product Specifications 18

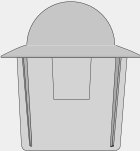
OVERVIEW

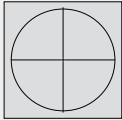
This In-CEILING HOUSING is a mounting ADAPTOR that is designed to mount the smart dome camera in built-in style on a double-layer ceiling.

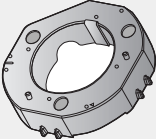
WHAT'S INCLUDED

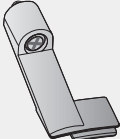
		
HOUSING	SAFETY BRACKET (1EA)	SAFETY WIRE (1SET)
		
TEMPLATE (1EA)	SCREW (7EA)	LOWER BRACKET (1EA) Applicable model : SCP-3430/2430/3250/2250/2251 SCP-3371/2371/2271/2373/2273/6322 SNP-5300/6201/6320/5430
		
INSTALLATION MANUAL	Fixing Bracket (1EA)	

INSTALLATION INSTRUCTIONS

1. Select an installation position or place that can endure more than 4 times of the total weight of the installation structure.
2. At least 250mm or more of spare height is required above the **CEILING BOARD**.
3. **CEILING BOARD**'s thickness should be less than 40mm.
4. Be sure to secure the SAFETY WIRE to avoid a product fall.
5. If you want to attach the camera to the ADAPTOR, use the only provided SCREWS.

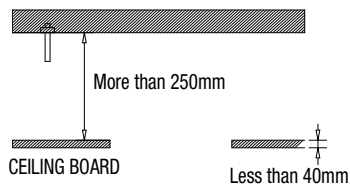

INSTALLATION (SCP-3430 SERIES)

Applicable model : SCP-3430/2430/3250/2250/2251

1. Place the **TEMPLATE** on the **CEILING BOARD** and drill a guided hole.
 - 1 Remove the round filling ("C") from the **TEMPLATE**.
 - 2 Place **TEMPLATE A** onto the **CEILING BOARD** to which you will attach the ceiling mount ADAPTOR and drill a hole of $\varnothing 219\text{mm}$ in diameter.See the figure below for the hole shape.

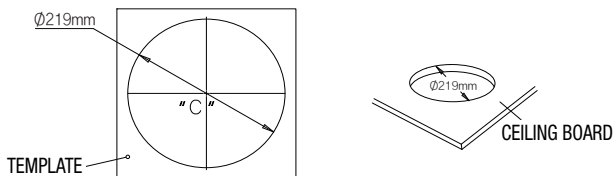

2. See the figure below to fix the lower **BRACKET** with the provided **SCREWS**.

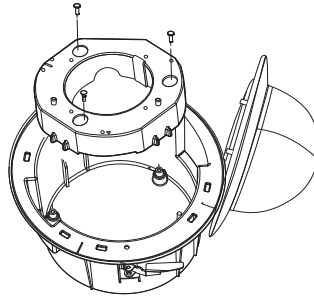

※ The lower BRACKET is specific to “SCP-3430 Series/SNP-5300 Series”.

3. Insert the **FRAME SET** included in the smart dome camera package into the **HOUSING** and fix it using 3 provided **SCREWS**.

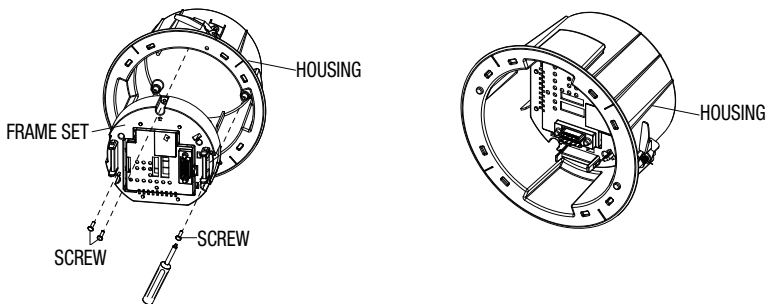

INSTALLATION (SCP-3430 SERIES)

Applicable model : SCP-3430/2430/3250/2250/2251

4. Fix the **ANCHOR BOLT** onto the concrete **CEILING**, and secure the **SAFETY WIRE** to the **ANCHOR BOLT** as below:
 - ① Tighten the nut ("N1") on the **ANCHOR BOLT**.
 - ② Insert the provided **SAFETY BRACKET** into the **ANCHOR BOLT**.
 - ③ Tighten two nuts ("N2", "N3") onto the **ANCHOR BOLT**.
 - ④ Hook and fix one end of the **SAFETY WIRE** onto the **SAFETY BRACKET**.
 - ⑤ Hook and fix the other end of **SAFETY WIRE** onto the **HOUSING** as shown below.

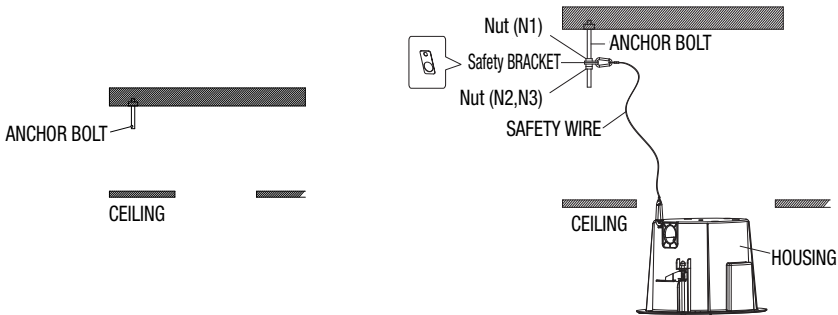

* The ANCHOR BOLTS and nuts are optional and not included in the product package.

5. Press the **SNAP-FIT** on the **ADAPTOR** to open it, and insert camera cables and external connection cables into the **HOUSING** through the side hole (see figure below).



- Refer to the installation manual of the camera that you want to install, and prepare necessary cables for camera connection.

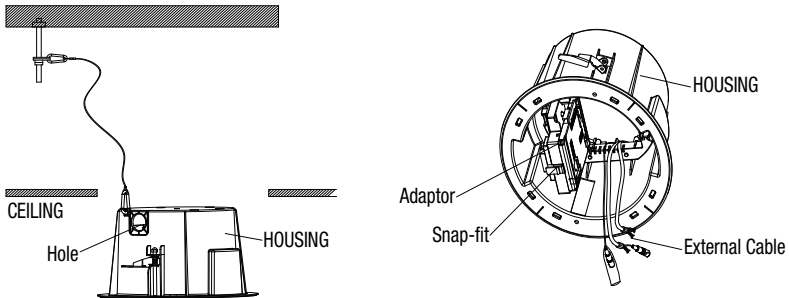

6. Push the **HOUSING** inside the **CEILING** through the **CEILING** hole, and tighten the **SCREWS** (x2) clockwise to fix the **HOUSING** on the **CEILING**.
(The **BRACKET** will be positioned from <A> to as shown.)

-  ■ Ensure that the **HOUSING** is firmly secured to the **CEILING BOARD**.

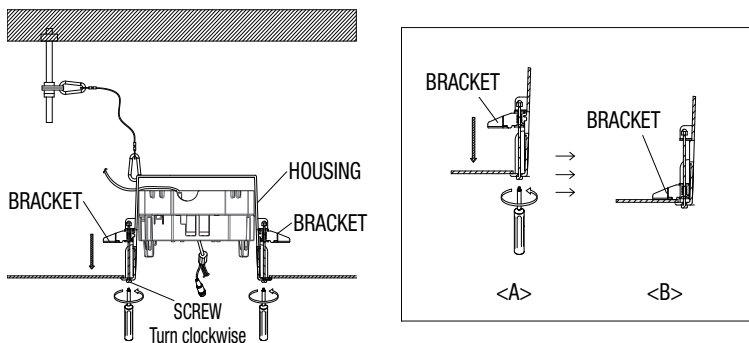

7. Connect external cables to the **CONNECTOR** (ALARM-IN, POWER, RS-485 and ALARM OUT) that is provided with the camera to be installed, and fit the **CONNECTOR** into the **ADAPTOR**.

Push in the cables inside the **FRAME**, and close the **ADAPTOR**.

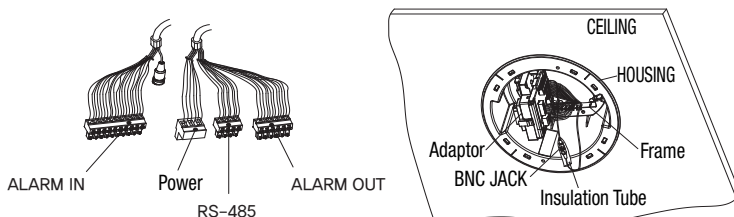



-  ■ Make sure that you wrap the **BNC JACK** with the insulation tube and use the insulation tape to seal up the end of the insulation tube lest that it should protrude.
For more information about the cable connection, refer to the installation manual of the camera.

INSTALLATION (SCP-3430 SERIES)

Applicable model : SCP-3430/2430/3250/2250/2251

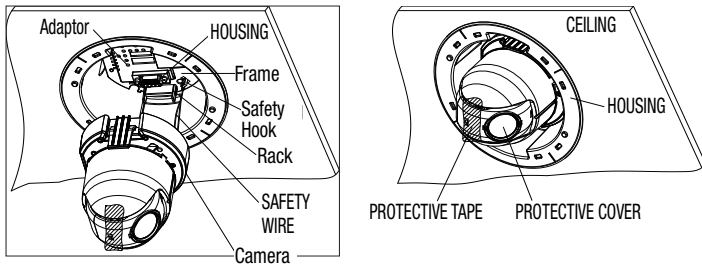
8. Hook the **SAFETY WIRE** to the **FRAME's SAFETY HOOK**.
Align the camera with the **22-Pin CONNECTOR** of the **ADAPTOR**, and push the **HOOK** on either end of the **CAMERA** in the **RACK** direction of the **FRAME-SET** to secure the two.



-  ■ When the installation is completed, remove both **PROTECTIVE TAPE** and **PRETOECTIVE COVER** from the lens.

9. Attach the **COVER** to the **HOUSING**. Fit the corner groove of the cover into one of 4 grooves on the HOUSING before fixing it.

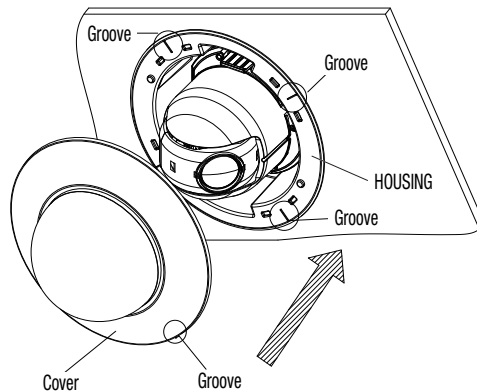

INSTALLATION (SCP-3370/SNP-5200 SERIES)

Applicable model : SCP-3370/2370/2330/2270
SNP-3371/3302/5200/6200

- Place the **TEMPLATE** on the **CEILING BOARD** and drill a guided hole.
 - Remove the round filling ("C") from the **TEMPLATE**.
 - Place the **TEMPLATE A** onto the **CEILING BOARD** to which you will attach the **CEILING** mount **ADAPTOR** and drill a $\varnothing 219\text{mm}$ hole.

See the figure below for the hole shape.

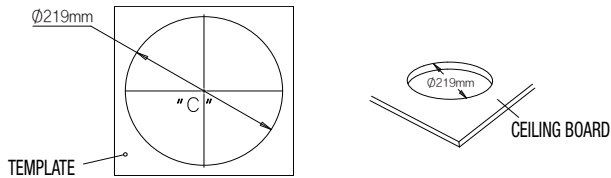

- See the figure below to fix the **INSTALL BASE** that is provided as a camera accessory.

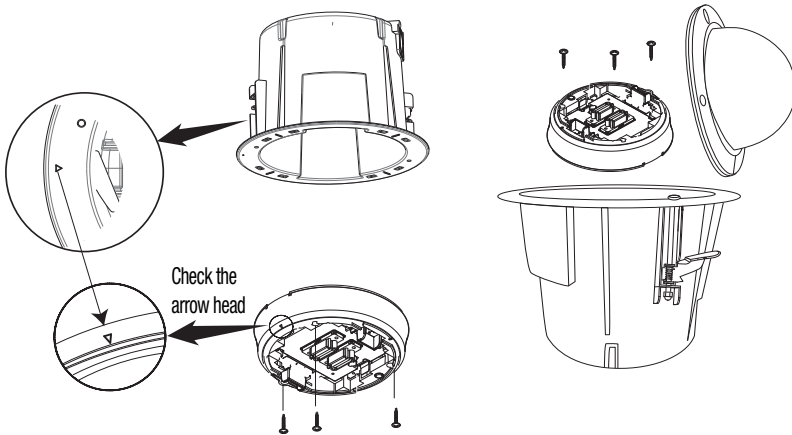

INSTALLATION (SCP-3370/SNP-5200 SERIES)

Applicable model : SCP-3370/2370/2330/2270
SNP-3371/3302/5200/6200

3. Fix the **ANCHOR BOLT** onto the concrete **CEILING**, and secure the **SAFETY WIRE** to the **ANCHOR BOLT** as below:
 - 1 Tighten the **NUT** ("N1") on the **ANCHOR BOLT**.
 - 2 Insert the provided **SAFETY BRACKET** into the **ANCHOR BOLT**.
 - 3 Tighten two **NUTS** ("N2", "N3") onto the **ANCHOR BOLT**.
 - 4 Hook and fix one end of the **SAFETY WIRE** onto the **SAFETY BRACKET**.
 - 5 Hook and fix the other end of **SAFETY WIRE** onto the **HOUSING** as shown below:

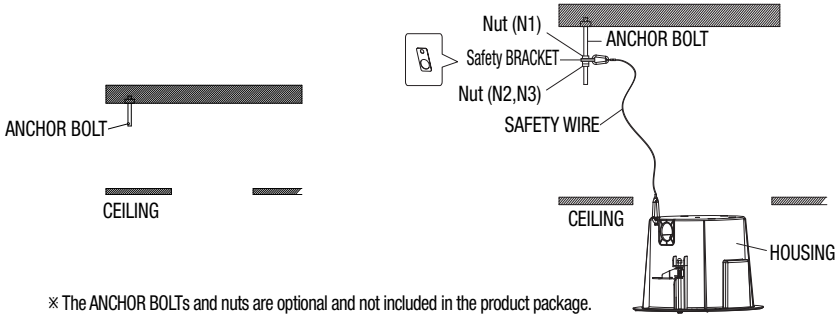

4. Press the **SNAP-FIT** on the **ADAPTOR** to open it, and insert camera cables and external connection cables into the **HOUSING** through the side hole (see figure below).



- Refer to the installation manual of the camera that you want to install, and prepare necessary cables for camera connection.

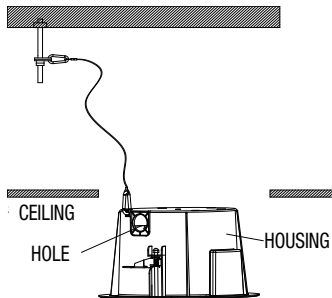

5. Push the **HOUSING** inside the CEILING through the CEILING hole, and tighten the **SCREWS** (x2) clockwise to fix the **HOUSING** on the CEILING.
(The **BRACKET** will be positioned from <A> to as shown.)



- Ensure that the **HOUSING** is firmly secured to the **CEILING BOARD**.

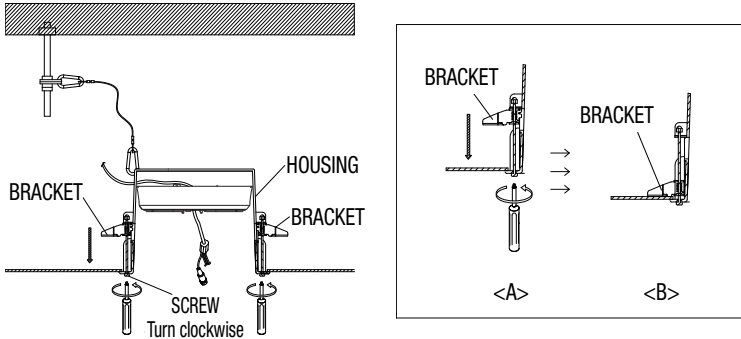

6. **Arrange camera cables and close the hinge door**
Connect the cables to the terminal block on the hinge door.
For details, refer to “Camera Wiring” of the camera’s installation manual.
When done, close the hinge door.

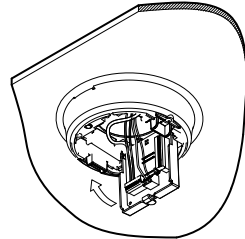

7. DIP Switch Setting

On the bottom of the camera unit, there are located one DIP switch for communications and another DIP switch for ID setting. For more information, refer to the camera’s installation manual.

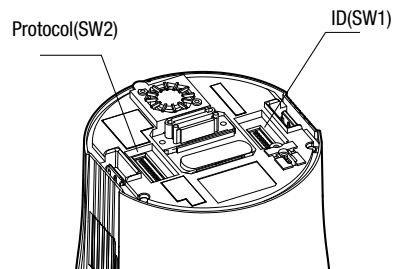

INSTALLATION (SCP-3370/SNP-5200 SERIES)

Applicable model : SCP-3370/2370/2330/2270
SNP-3371/3302/5200/6200

8. Installing the camera

Install the camera in the arrow direction as shown. Connect the SAFETY WIRE before installing the camera.

The SAFETY WIRE is of the spring type that is locked on the INSTALL BASE. As shown in the left figure, pull up the wire from the INSTALL BASE to hook it to the SAFETY WIRE hook.

× When attaching the camera to the mount, check the arrow directions in the figure below before proceeding.

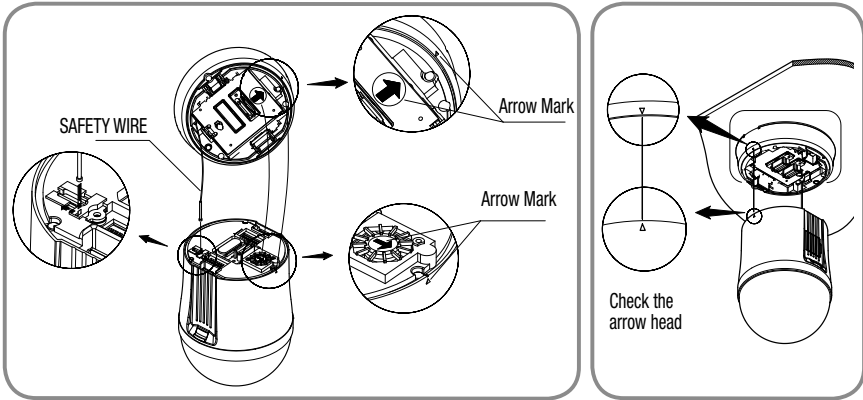

9. Remove the dome cover from the camera, and install the **cover** onto the **HOUSING**.

Fit the corner groove of the cover into one of 4 grooves on the HOUSING before fixing it.

× Installing the camera without removing the dome cover will cause an image out of focus.

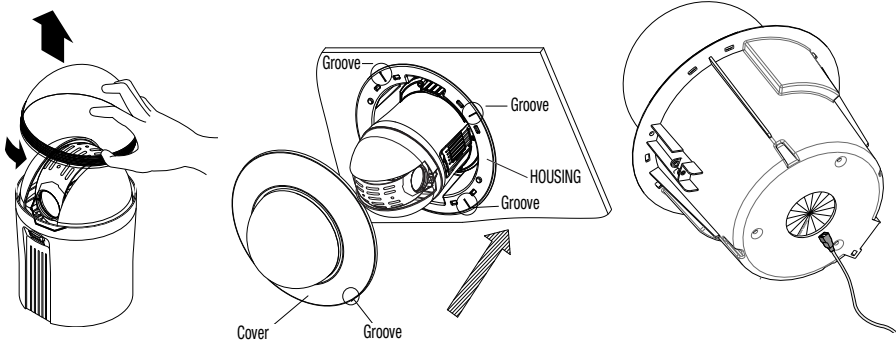

× When working on the network PTZ camera, arrange the network cables through the bottom hole of the HOUSING.

INSTALLATION (SCP-3371/SNP-5300 SERIES)

Applicable model : SCP-3371/2371/2271/2373/2273/6322
SNP-5300/6201/6320/5430

1. Place the **TEMPLATE** on the **CEILING BOARD** and drill a guided hole.
 - ① Remove the round filling ("C") from the **TEMPLATE**.
 - ② Place **TEMPLATE A** onto the **CEILING BOARD** to which you will attach the ceiling mount ADAPTOR and drill a hole of $\varnothing 219\text{mm}$ in diameter.

See the figure below for the hole shape.

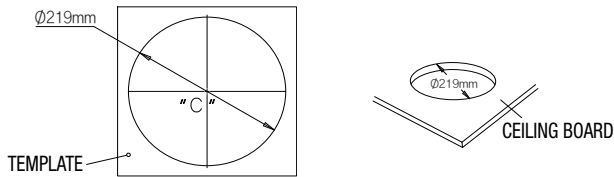

2. See the figure below to fix the lower **BRACKET** with the provided **SCREWS**.

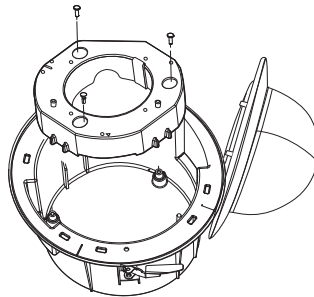

※ The lower BRACKET is specific to "SCP-3430 Series/SNP-5300 Series".

INSTALLATION (SCP-3371/SNP-5300 SERIES)

Applicable model : SCP-3371/2371/2271/2373/2273/6322
SNP-5300/6201/6320/5430

3. Connect the **install base** included in the PTZ camera to the **housing** for installation using the 4 screws that are included as accessories.

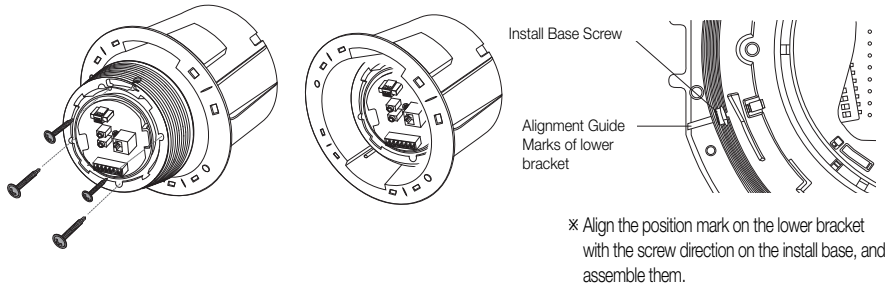

4. Fix the **ANCHOR BOLT** onto the concrete **CEILING**, and secure the **SAFETY WIRE** to the **ANCHOR BOLT** as below:
 - 1 Tighten the **NUT** ("N1") on the **ANCHOR BOLT**.
 - 2 Insert the provided **SAFETY BRACKET** into the **ANCHOR BOLT**.
 - 3 Tighten two **NUTS** ("N2", "N3") onto the **ANCHOR BOLT**.
 - 4 Hook and fix one end of the **SAFETY WIRE** onto the **SAFETY BRACKET**.
 - 5 Hook and fix the other end of **SAFETY WIRE** onto the **HOUSING** as shown below:

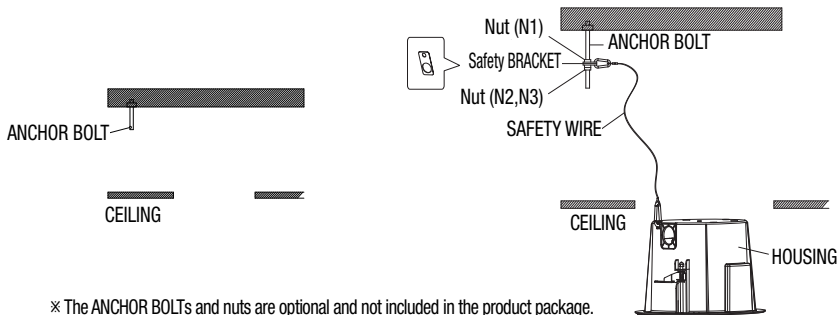

5. Press the **SNAP-FIT** on the **ADAPTOR** to open it, and insert camera cables and external connection cables into the **HOUSING** through the side hole (see figure below).



- Refer to the installation manual of the camera that you want to install, and prepare necessary cables for camera connection.

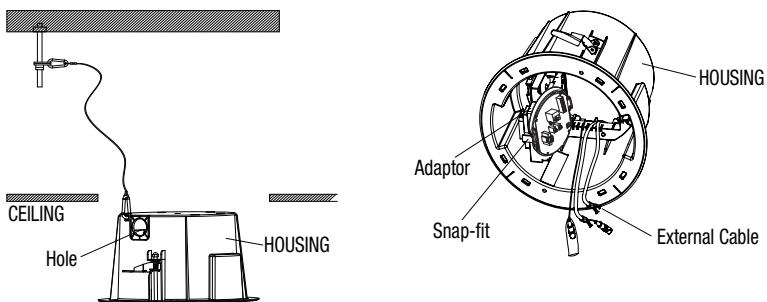

6. Push the **HOUSING** inside the **CEILING** through the **CEILING** hole, and tighten the **SCREWS** (x2) clockwise to fix the **HOUSING** on the **CEILING**.
(The **BRACKET** will be positioned from <A> to as shown.)



- Ensure that the **HOUSING** is firmly secured to the **CEILING BOARD**.

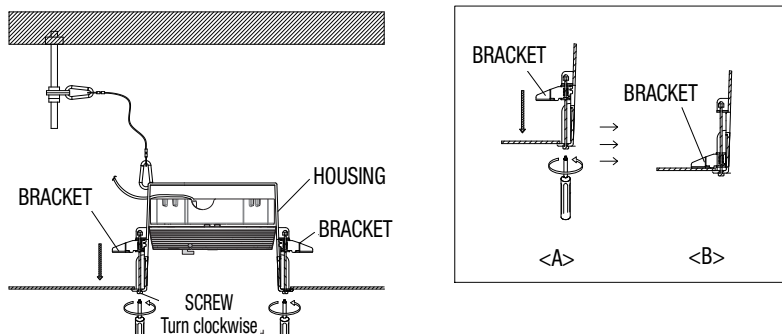

INSTALLATION (SCP-3371/SNP-5300 SERIES)

Applicable model : SCP-3371/2371/2271/2373/2273/6322
SNP-5300/6201/6320/5430

7. Camera Cable Arrangement and Hinged Door Close

Connect the cable to the terminal block on the hinged door. Please refer to 'Camera Cabling Diagram' in the installation manual. After cabling, please close the hinged door.

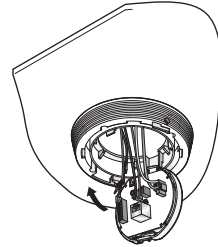

8. Camera Installation

Insert the fixing bracket into the camera bezel. Connect the safety cable first, and then assemble the camera. The safety cable is wound around the install base like a spring. Pull from the install base as shown in the figure below to mount onto the hook of the safety cable. After mounting the install base as shown in the figure, turn the unit in a clockwise direction. After turning the unit, connect the screw on the fixing bracket to the lower bracket.

※ To attach the camera to the mount, refer to the alignment guide marks as shown in the figure.

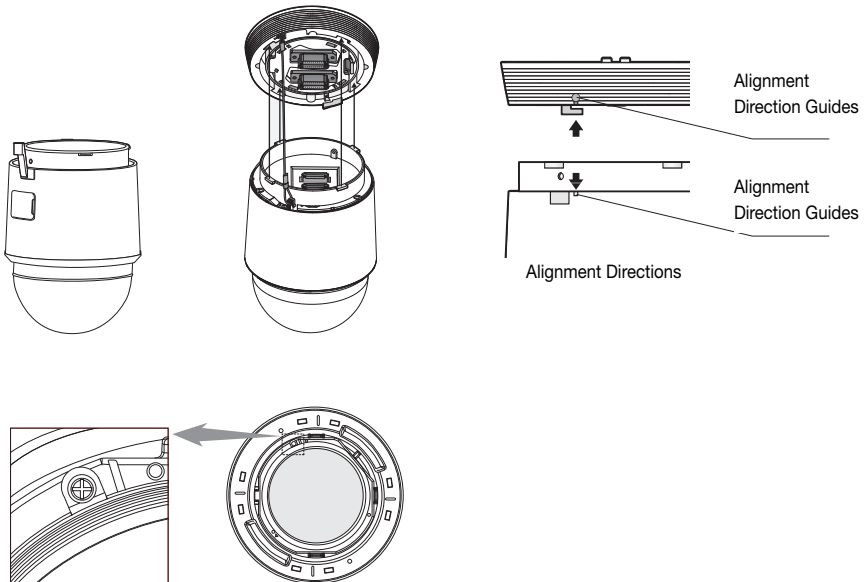

9. Remove the dome cover from the camera, and install the **cover** onto the **HOUSING**.
Fit the corner groove of the cover into one of 4 grooves on the HOUSING before fixing it.
※ Installing the camera without removing the dome cover will cause an image out of focus.

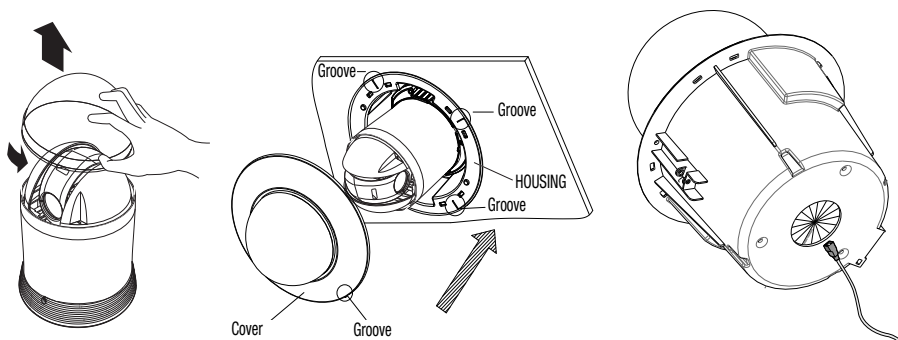

- ※ When working on the network PTZ camera, arrange the network cables through the bottom hole of the HOUSING.

PRODUCT SPECIFICATIONS

Item	Specifications
Dimension (mm)	Ø254 X H276.4
Weight	830g
Temperature	-10° ~ 50°
Material	PC + ABS
Color	Ivory

Unit : mm (Inches)

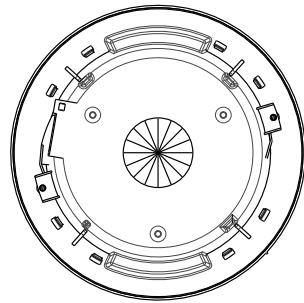
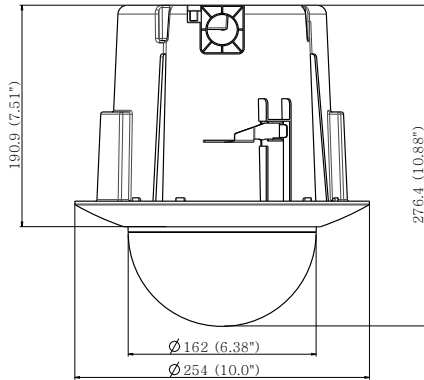

MEMO

A large, empty rectangular area with rounded corners, intended for writing a memo. The area is bounded by a thin grey line and occupies most of the page below the 'MEMO' header.

Head Office

6, Pangyo-ro 319 beon-gil, Bundang-gu, Seongnam-si,
Gyeonggi-do, 463-400 Rep. of KOREA
Tel : +82.70.7147.8753 Fax : +82.31.8018.3740
www.hanwha-security.com

Hanwha Techwin America

500 Frank W. Burr Blvd. Suite 43 Teaneck, NJ 07666
Toll Free +1.877.213.1222 Direct +1.201.325.6920
Fax +1.201.373.0124
www.hanwha-security.com

Hanwha Techwin Europe

Heriot House, Heriot Road, Chertsey, Surrey, KT16 9DT, United Kingdom
Tel +44.1932.57.8100 Fax +44.1932.57.8101
www.hanwha-security.eu
