

**WISENET**

# **In-ceiling Housing**

## Installation Manual

SHD-3000F2



# TABLE OF CONTENTS





---

|                                  |   |
|----------------------------------|---|
| Overview .....                   | 3 |
| What's Included .....            | 3 |
| Installation Instructions .....  | 4 |
| Installation (indoor type) ..... | 4 |
| Product Specifications .....     | 8 |

# OVERVIEW

This In-CEILING HOUSING is a mounting ADAPTOR that is designed to mount the smart dome camera in built-in style on a double-layer ceiling.

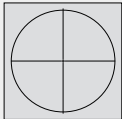
## WHAT'S INCLUDED

|                                                                                    |                                                                                    |                                                                                    |
|------------------------------------------------------------------------------------|------------------------------------------------------------------------------------|------------------------------------------------------------------------------------|
|   |   |   |
| HOUSING                                                                            | SAFETY BRACKET (1EA)                                                               | SAFETY WIRE (1SET)                                                                 |
|  |  |  |
| TEMPLATE (1EA)                                                                     | outdoor type (3EA)<br>indoor type (2EA)                                            | INSTALLATION MANUAL                                                                |

# INSTALLATION INSTRUCTIONS

---

1. Select an installation position or place that can endure more than 4 times of the total weight of the installation structure.
2. At least 250mm or more of spare height is required above the **CEILING BOARD**.
3. **CEILING BOARD**'s thickness should be less than 40mm.
4. Be sure to secure the SAFETY WIRE to avoid a product fall.
5. If you want to attach the camera to the ADAPTOR, use the only provided SCREWS.

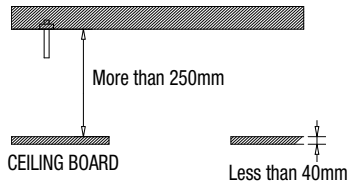

## INSTALLATION (INDOOR TYPE)

---

1. Place the **TEMPLATE** on the **CEILING BOARD** and drill a guided hole.
  - 1 Remove the round filling ("C") from the **TEMPLATE**.
  - 2 Place **TEMPLATE A** onto the **CEILING BOARD** to which you will attach the ceiling mount ADAPTOR and drill a hole of  $\varnothing 165\text{mm}$  in diameter.See the figure below for the hole shape.

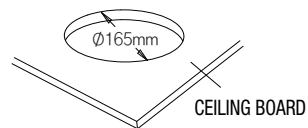
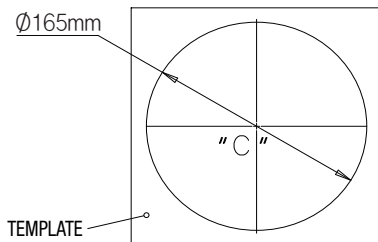

- Fix the **ANCHOR BOLT** onto the concrete **CEILING**, and secure the **SAFETY WIRE** to the **ANCHOR BOLT** as below:

- Tighten the nut ("N1") on the **ANCHOR BOLT**.
- Insert the provided **SAFETY BRACKET** into the **ANCHOR BOLT**.
- Tighten two nuts ("N2", "N3") onto the **ANCHOR BOLT**.
- Hook and fix one end of the **SAFETY WIRE** onto the **SAFETY BRACKET**.
- Hook and fix the other end of **SAFETY WIRE** onto the **HOUSING** as shown below.

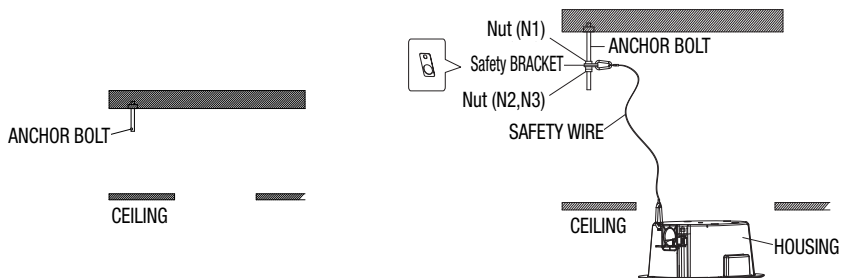

※ The ANCHOR BOLTS and nuts are optional and not included in the product package.

- To connect to the camera, insert the external cable through the side **hole** on the **housing** to the inside of the **housing** as shown in the figure.



- Refer to the installation manual of the camera that you want to install, and prepare necessary cables for camera connection.

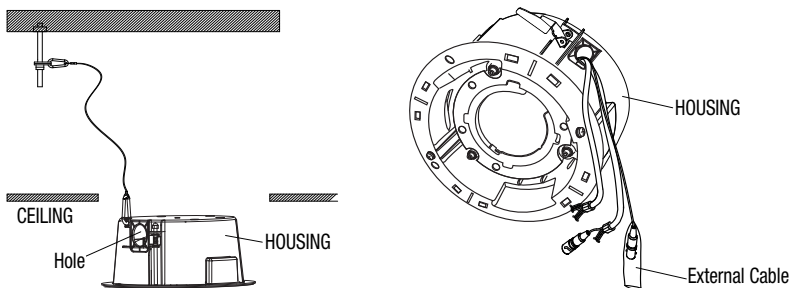

4. Push the **HOUSING** inside the **CEILING** through the **CEILING** hole, and tighten the **SCREWS** (x2) clockwise to fix the **HOUSING** on the **CEILING**.  
(The **BRACKET** will be positioned from <A> to <B> as shown.)



- Ensure that the **HOUSING** is firmly secured to the **CEILING BOARD**.

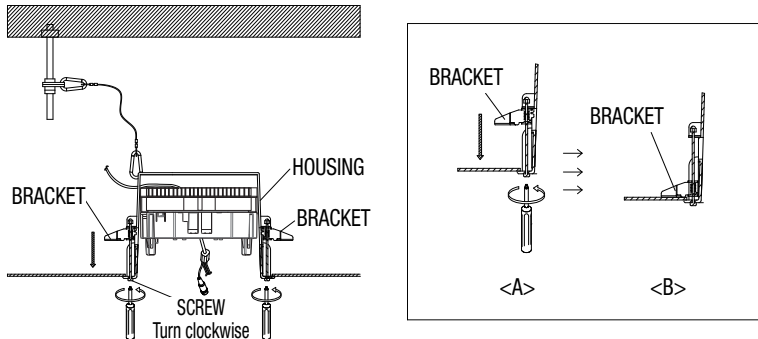

5. Remove the dome cover from the camera

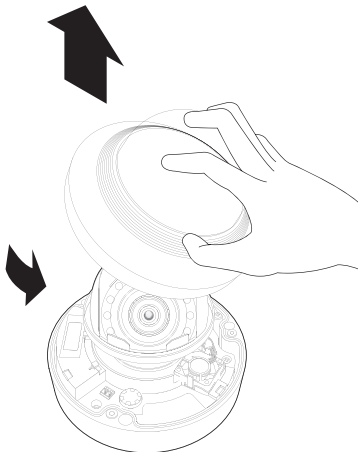

## 6. Installing the camera

Using the three screws, mount the camera in the housing.

※ When attaching the camera to the mount, check the arrow directions in the figure below before proceeding.

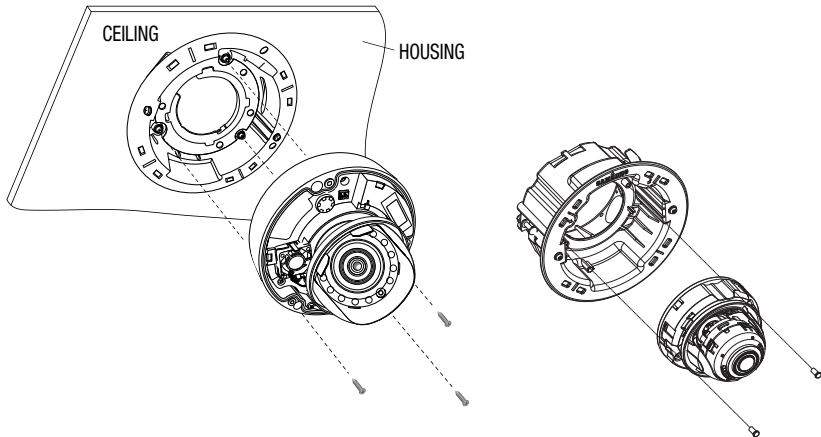

## 7. install the cover onto the HOUSING.

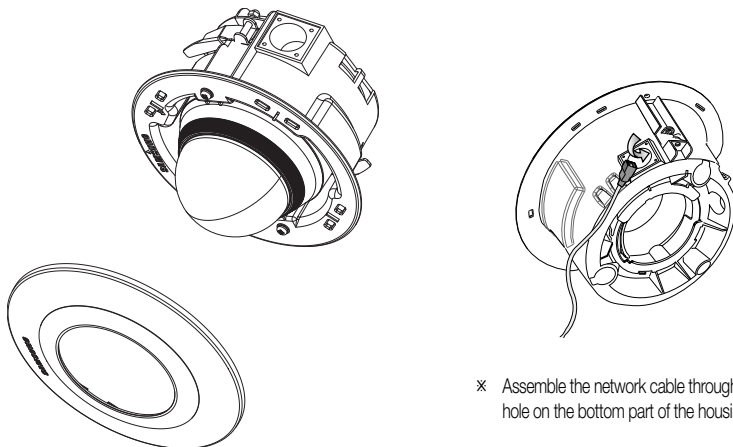

※ Assemble the network cable through the hole on the bottom part of the housing.

# PRODUCT SPECIFICATIONS

| Item           | Specifications |
|----------------|----------------|
| Dimension (mm) | D194 X H102    |
| Weight         | 350g           |
| Temperature    | -10°C ~ 50°C   |
| Material       | PC             |
| Color          | Ivory          |

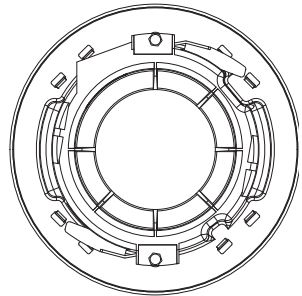
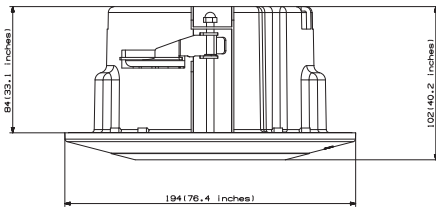



MEMO

---

**Head Office**

6, Pangyo-ro 319 beon-gil, Bundang-gu, Seongnam-si,  
Gyeonggi-do, 463-400 Rep. of KOREA  
Tel : +82.70.7147.8753 Fax : +82.31.8018.3740  
[www.hanwha-security.com](http://www.hanwha-security.com)

---

**Hanwha Techwin America**

500 Frank W. Burr Blvd. Suite 43 Teaneck, NJ 07666  
Toll Free +1.877.213.1222 Direct +1.201.325.6920  
Fax +1.201.373.0124  
[www.hanwha-security.com](http://www.hanwha-security.com)

---

**Hanwha Techwin Europe**

Heriot House, Heriot Road, Chertsey, Surrey, KT16 9DT, United Kingdom  
Tel +44.1932.57.8100 Fax +44.1932.57.8101  
[www.hanwha-security.eu](http://www.hanwha-security.eu)

---