

**WISeNET**

# **TERMALNA KAMERA POZYCJONUJĄCA**

Instrukcja obsługi

TNU-4041T  
TNU-4051T

**CE**

# TERMALNA KAMERA POZYCJONUJĄCA

## Instrukcja obsługi

---

### Prawa autorskie

©2018 Hanuha Techwin Co., Ltd. Wszelkie prawa zastrzeżone.

### Znaki towarowe

Wszystkie znaki handlowe wymienione w niniejszym dokumencie są zastrzeżone. Nazwa niniejszego produktu i inne znaki handlowe wymienione w niniejszym podręczniku są zastrzeżonymi znakami handlowymi odpowiednich właścicieli.

### Ograniczenia

Prawa autorskie do tego dokumentu są zastrzeżone. Kopiowanie, rozpowszechnianie lub modyfikowanie treści niniejszego dokumentu, częściowo lub w całości, bez formalnego zezwolenia, jest zabronione.

### Wyłączenie odpowiedzialności

Firma Hanuha Techwin przedsięwzięła wszelkie wysiłki, aby zapewnić spójność i poprawność treści niniejszej publikacji, ale nie zapewnia formalnych gwarancji. Użytkownik bierze pełną odpowiedzialność za stosowanie tego dokumentu i wyniki rezultaty. Firma Hanuha Techwin zastrzega sobie prawo do zmiany treści tego dokumentu bez uprzedzenia.

- ❖ Konstrukcja i dane techniczne urządzenia mogą ulec zmianie bez powiadomienia.
- ❖ Początkowym ID administratora jest "admin" a hasło powinno zostać ustawione podczas pierwszego logowania.  
Dla zabezpieczenia informacji i zapobieżenia szkodom, hasło należy zmieniać co trzy miesiące.  
Proszę pamiętać, że odpowiedzialność za bezpieczeństwo i wszelkie szkody wynikające z braku dbałości o hasło.

## WAŻNE ZALECENIA DOTYCZĄCE BEZPIECZEŃSTWA

- Należy przeczytać poniższe zalecenia.
- Należy zachować je do wglądu.
- Należy przeczytać wszystkie ostrzeżenia.
- Należy przestrzegać wszystkich zaleceń.
- Nie używać urządzenia w pobliżu wody.
- Zabrudzoną powierzchnię produktu wyczyść miękką, suchą szmatką lub wilgotną szmatką. (Nie używaj żadnych detergentów ani produktów kosmetycznych zawierających alkohol, rozpuszczalniki, surfaktanty lub substancje oleiste, ponieważ mogą one spowodować odkształcenie lub uszkodzenie produktu).
- Nie blokować żadnych otworów wentylacyjnych. Montować zgodnie z instrukcją producenta.
- Nie montować w pobliżu źródeł ciepła takich jak grzejniki, kratki nagrzewnic lub innych urządzeń (w tym wzmacniaczy) emitujących ciepło.
- Nie lekceważać zabezpieczenia wynikającego ze stosowania wtyczek spolaryzowanych lub z uziemieniem. Wtyczka spolaryzowana ma dwa bolce, z których jeden jest szerszy od drugiego. Wtyczka z uziemieniem ma trzy bolce, z czego jeden jest uziemiający. Szerszy lub odpowiednio trzeci bolec stosuje się w celu zapewnienia bezpieczeństwa. Jeśli dostarczona wtyczka nie pasuje do gniazda, skontaktuj się z elektrykiem w celu wymiany przestarzałego gniazda.
- Przewód zasilający przy wtyczkach, oprawach oraz w miejscach, gdzie wystają one z urządzenia należy zabezpieczyć przed możliwością nadeptnięcia lub przyciśnięcia.
- Używać wyłącznie elementów dodatkowych/akcesoriów zalecanych przez producenta.
- Kamery należy używać tylko z wózkiem, podstawą, statywem, uchwytem lub stołem zalecanym przez producenta lub sprzedawanym z kamerą. W przypadku użycia wózka podczas przemieszczania zestawu wózek-urządzenie należy zachować ostrożność, aby uniknąć obrażeń spowodowanych jego wywróceniem.
- W czasie burzy z wyładowaniami atmosferycznymi lub w przypadku nieużywania urządzenia przez dłuższy czas należy odłączyć urządzenie od zasilania.
- Wszelkie naprawy należy zlecać wykwalifikowanemu personelowi serwisu. Naprawy są konieczne gdy urządzenie zostało uszkodzone w jakikolwiek sposób, np. gdy uszkodzony jest przewód zasilający lub wtyczka, do środka urządzenia przedostał się płyn lub ciała obce, urządzenie miało kontakt z deszczem lub wilgocią, nie funkcjonuje normalnie lub spadło.
- Do zasilania tego produktu przewidziano atestowany zasilacz kategorii „Class 2” lub „LPS” o parametrach znamionowych od 24 V AC (50 lub 60 Hz), min. 6 A.
- Użycie zbyt dużej siły podczas instalacji produktu może doprowadzić do uszkodzenia i nieprawidłowego działania kamery. Instalacja produktu przy użyciu siły i nieodpowiednich narzędzi może doprowadzić do jego uszkodzenia.
- Produktu nie należy instalować w miejscu, w którym mogą występować lub powstawać substancje chemiczne lub mgły olejowe. Oleje jadalne, takie jak olej sojowy, mogą uszkodzić lub odkształcić produkt, w związku z czym nie należy instalować go w kuchni lub w pobliżu blatu kuchennego. W przeciwnym razie produkt może ulec uszkodzeniu.
- Podczas instalacji produktu należy uważać, aby jego powierzchnia nie została zabrudzona substancjami chemicznymi. Niektóre substancje chemiczne zawierające rozpuszczalniki lub kleje mogą powodować poważne uszkodzenie powierzchni produktu.
- W przypadku instalacji lub demontażu produktu w sposób inny niż zalecany nie można zagwarantować prawidłowego działania funkcji i wydajności produktu. Zainstaluj produkt, zapoznając się z rozdziałem „Instalacja i podłączenie (Installation and connection)” w podręczniku użytkownika.
- Instalacja lub eksploatacja produktu w wodzie może doprowadzić do jego poważnego uszkodzenia.



## OSTRZEŻENIE

ABY ZMNIJSZYĆ RYZYKO POŻARU LUB PORAŻENIA PRĄDEM ELEKTRYCZNYM, NIE NALEŻY WYSTAWIAĆ URZĄDZENIA NA DZIAŁANIE WODY ANI WILGOCI. DO NOT INSERT ANY METALLIC OBJECT THROUGH THE VENTILATION GRILLS OR OTHER OPENINGS ON THE EQUIPMENT.

Nie należy narażać urządzenia na kapanie lub rozlewanie płynów. Na urządzeniu nie należy stawiać przedmiotów wypełnionych cieczą np. wazonów.

Aby zapobiec obrażeniom, urządzenie należy dobrze przymocować do ściany/sufitu, zgodnie z instrukcjami montażu.

## UWAGA

	<b>UWAGA</b> NIEBEZPIECZEŃSTWO PORAŻENIA PRĄDEM. NIE OTWIERAĆ	
<b>UWAGA : ABY ZMNIJSZYĆ RYZYKO PORAŻENIA PRĄDEM NIE USUWAĆ OBUDOWY (ANI CZĘŚCI TYLNEJ). NIE MA CZĘŚCI PRZEZNACZONYCH DO NAPRAWY PRZEZ UŻYTKOWNIKA. NALEŻY SKONTAKTOWAĆ SIĘ Z WYKWALIFIKOWANYM PERSONELEM SERWISU.</b>		

## WYJAŚNIENIE SYMBOLI GRAFICZNYCH



Równoboczny trójkąt ostrzegawczy ze znakiem błyskawicy zakończony strzałką przestrzega przed “niebezpiecznym napięciem” wewnątrz urządzenia, które może mieć wystarczająco wysokie natężenie, aby stanowić zagrożenie porażenia prądem elektrycznym.



Trójkąt równoboczny z wykrzyknikiem to symbol wskazujący, że dokumentacja dołączona do urządzenia zawiera ważne instrukcje dotyczące obsługi i konserwacji (serwisowania).

## Klasa I konstrukcji

Urządzenie z konstrukcją KLASA I należy podłączać do gniazda SIECI ELEKTRYCZNEJ za pomocą zabezpieczonych przewodów uziemiających.

## Akumulator

Akumulatorów (znajdującego się w urządzeniu zestawu akumulatorów lub akumulatora) nie należy wystawiać na działanie zbyt wysokiej temperatury, np. promieni słonecznych, ognia itp.

## Odlączenie urządzenia

Jeśli urządzenie jest uszkodzone, odłącz je z sieci zasilającej. Wezwij także lokalnego technika serwisowego.

**Jeśli urządzenie jest używane poza granicami Stanów Zjednoczonych, może być stosowane ze wtyczkami z kodami atestów odpowiednich urzędów.**

## UWAGA

Istnieje ryzyko eksplozji, jeśli użyto baterii niewłaściwego typu. Zużyte baterie utylizować zgodnie z zaleceniami.

Poniższe instrukcje serwisowania są przeznaczone wyłącznie na użytek wykwalifikowanych pracowników serwisu.

Ze względu na zagrożenie porażeniem prądem elektrycznym osoby nieposiadające odpowiednich kwalifikacji nie powinny wykonywać czynności serwisowych innych niż opisane w poniższej instrukcji.

Terminal CVBS służy łatwiejszej instalacji oraz nie jest zalecany dla celów monitoringu.

Należy doprowadzać zasilanie wejściowe tylko do jednej kamery i nie należy do niego podłączać innych urządzeń.

Należy uważnie przeczytać poniższe zasady bezpieczeństwa.

- Nie należy umieszczać tego urządzenia na nierównej powierzchni.
- Urządzenia nie należy instalować na powierzchni wystawionej bezpośrednio na działanie promieni słonecznych, w pobliżu grzejników lub w miejscach o bardzo niskiej temperaturze.
- Nie umieszczać urządzenia w pobliżu materiałów przewodzących.
- Nie należy samodzielnie podejmować prób naprawy urządzenia.
- Na urządzeniu nie należy stawiać pojemników z wodą.
- Produktu nie należy instalować w pobliżu urządzeń emitujących pola magnetyczne.
- Nie zasłaniać otworów wentylacyjnych.
- Na urządzeniu nie należy kłaść ciężkich przedmiotów.
- Podczas instalacji i demontażu kamery należy używać rękawic ochronnych. Wysoka temperatura powierzchni produktu może spowodować poparzenia ciała.

Instrukcja obsługi zawiera wytyczne dotyczące użytkowania produktu.

W niniejszej instrukcji obsługi informacje są oznaczone jako.

- Informacje dodatkowe : wytyczne dotyczące użytkowania produktu
- Uwaga : informacje o występowaniu ryzyka uszkodzenia produktu lub obrażenia użytkownika w wyniku nieprzestrzegania instrukcji
- ※ W celu zapewnienia bezpieczeństwa przed rozpoczęciem korzystania z urządzenia należy zapoznać się z poniższą instrukcją obsługi i przechowywać ją w bezpiecznym miejscu.

W niektórych środowiskach montażowych mogą wystąpić zakłócenia w komunikacji radiowej. W przypadku wystąpienia zakłóceń fal elektromagnetycznych między produktem a urządzeniem komunikacji radiowej zaleca się zachowanie pewnej odległości między nimi lub zmianę kierunku anteny odbiorczej.

## SPIS TREŚCI

### INFORMACJE OGÓLNE

3

- 3 Ważne zalecenia dotyczące bezpieczeństwa
- 6 Zalecane Specyfikacje Komputera PC
- 6 Zalecane Specyfikacje Kart Pamięci Micro SD/SDHC/SDXC
- 6 Specyfikacja zalecana przez NAS
- 7 Co znajduje się w opakowaniu
- 8 Spojrzenie na Kamere

### INSTALACJA I PODŁĄCZANIE

9

- 9 Instalacja
- 10 Wkładanie/Wyjmowanie Karty Pamięci Micro SD
- 11 Informacje o Karcie Pamięci (Niedołączonej do Zestawu)
- 12 Podłączanie Innego Urządzenia

### POŁĄCZENIE SIECIOWE I KONFIGURACJA

15

- 15 Podłączanie Kamery Bezpośrednio do Sieci Lokalnej
- 15 Podłączanie Kamery Bezpośrednio do Modemu DSL/telewizji Kablowej Opartego na Protokole DHCP
- 16 Podłączanie Kamery Bezpośrednio do Modemu PPPoE
- 16 Podłączanie Kamery do Ruter szerokopasmowy z Modemem PPPoE lub Kablowym
- 17 Korzystanie z programu Device Manager
- 17 Automatyczne wyszukiwanie kamery
- 17 Konfigurowanie adresu IP
- 18 Ręczna rejestracja kamery
- 18 Automatyczna konfiguracja IP
- 19 Konfigurowanie Przekazywania Zakresu Portów (Mapowania Portów)
- 20 Podłączanie do Kamery za Pomocą Udostępnionego Lokalnego Komputera
- 20 Podłączanie do Kamery ze Zdalnego Komputera Przez Internet

### PRZEGLĄDARKA INTERNETOWA

21

- 21 Podłączanie do Kamery
- 21 Ustawienia hasła
- 22 Logowanie
- 22 Specyfikacja obsługi wtyczek dla każdej przeglądarki
- 22 Instalacja Dodatku WebViewer
- 22 Użytkowanie bezpłatnej wtyczki przeglądarki

### DODATEK

23

- 23 Rozwiązywanie Problemów
- 24 Open Source Announcement

## ZALECANE SPECYFIKACJE KOMPUTERA PC

- **Procesor:** Intel(R) Core(TM) i7 3.4 GHz lub wyższy
- **Pamięć RAM:** 8 GB lub więcej
- **Obsługiwany system operacyjny:** Windows 7, 8.1, 10, Mac OS X 10.10, 10.11, 10.12
- **Webviewer**  
Zalecana przeglądarka: Google Chrome 63  
Obsługiwane przeglądarki: IE11, MS Edge 41, Mozilla Firefox 57 (tylko Windows 64bit),  
Apple Safari 11 (tylko Mac OS X)

## ZALECANE SPECYFIKACJE KART PAMIĘCI MICRO SD/SDHC/SDXC

- **Zalecana pojemność:** Zalecana pojemność: od 16 do 256 GB (typ MLC)
- W przypadku tej kamery zalecane są następujące typy kart pamięci następujących producentów.
  - Producent: SanDisk, Transcend
  - Rodzina produktów: karty o dużej odporności

## SPECYFIKACJA ZALECANA PRZEZ NAS

- **Zalecana pojemność:** Zalecane jest 200GB lub więcej.
- **Dostęp jednoczesny:** Jednostka NAS może przyjąć do szesnastu dostępów do kamery.
- Dla tej kamery zalecane jest wykorzystanie NAS z następującą specyfikacją fabryczną.







Zalecane produkty	Dostępne rozmiary
QNAP NAS	Dostęp jednoczesny dla maksimum 16 kamer.
Synology NAS	Dostęp jednoczesny dla maksimum 16 kamer.







- Wykorzystanie urządzeń NAS dla celów innych niż zapis video może spowodować zmniejszenie dostępnej liczby kamer.

## CO ZNAJDUJE SIĘ W OPAKOWANIU

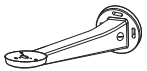
Należy sprawdzić, czy w opakowaniu znajduje się kamera oraz wszystkie akcesoria.  
(Akcesoria nie są identyczne i zależą od kraju sprzedaży)

Wygląd	Nazwa elementu	Liczba	Opis
	Korpus kamery	1	-
	Skrócona instrukcja obsługi (Opcjonalny)	1	-
	Karta gwarancyjna (Opcjonalny)	1	-
	Oslona przeciwsłoneczna	1	Ochronia kamerę przed bezpośrednim nasłonecznieniem.
	Uchwyt na osłonę przeciwsłoneczną	1	Umożliwia zamocowanie na kamerze osłony przeciwsłonecznej.
	Klucz gwiazdowy	1	Do zamocowania pokrywy gniazda pamięci
	Akcesorium wodoodporne RJ45	1	Do montażu w wilgotnych miejscach

Wygląd	Nazwa elementu	Liczba	Opis
<b>Uchwyt ścienny (not included)</b>			
	Uchwyt ścienny	1	Używany podczas montażu kamery na ścianie
	Śruby(M5 X 20)/podkładki płaskie	3/3	Do łączenia korpusu i wspornika
	Śruby(M3 x 8)	8	Do przykręcenia pokrywy przewodów
	Pierścień uszczelniający	1	Do łączenia korpusu i wspornika

SPOJRZENIE NA KAMERĘ

Wygląd

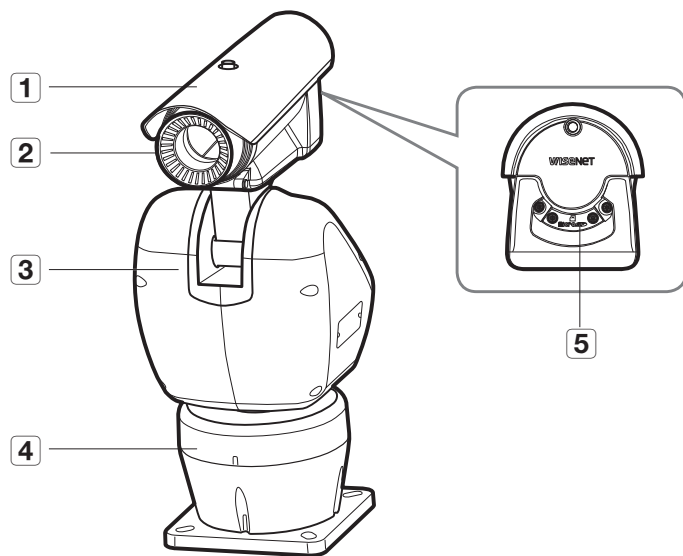

kable

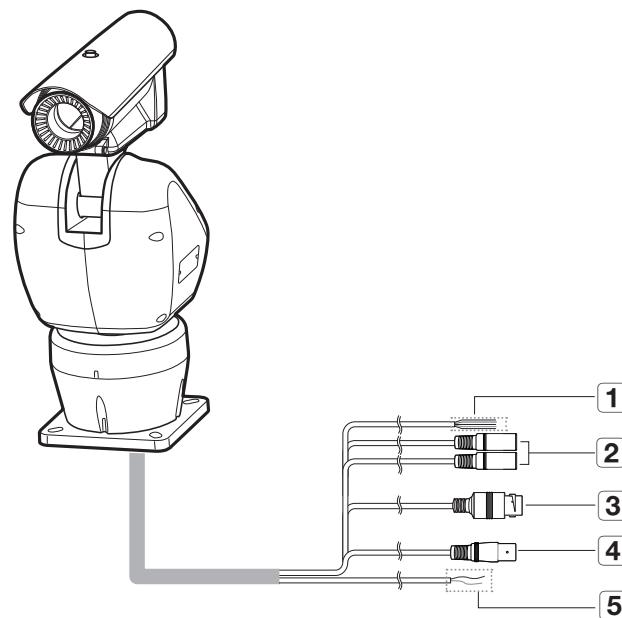

Element	
1	Oslona przeciwsloneczna
2	Kamera
3	Korpus glówny
4	Obudowa podstawy
5	Gniazdo kart Micro SD

Element	Opis
1 Przewód alarmu	Przewód wejścia alarmu (czarny/brązowy/czerwony/żółty/pomarańczowy)
2 Przewód audio	Przewód wejścia audio
3 Ethernet	Umożliwia podłączenie przewodu Ethernet.
4 Przewód wyjścia wideo	Umożliwia przesłanie sygnału wyjściowego wideo.
5 Przewód zasilający	Kable do zasilania kamery (Brązowy/Niebieski)



## INSTALACJA

### Środki ostrożności przed montażem

Przed przystąpieniem do montażu kamery należy przeczytać poniższe instrukcje:

- System zamontować w oparciu o poniższe wskazówki. W przypadku jeśli użytkownik chce system zainstalować inną metodą, najpierw powinien potwierdzić w porozumieniu z producentem zalecenia bezpieczeństwa.
- Masa całkowita systemu wynosi 11,7 kg. Należy założyć parę antypoślizgowych rękawic. Podnosząc urządzenie nie należy chwycić kamery, tylko jej korpus.
- Umieścić w miejscu (sufit lub ściana), które wytrzyma 4 ciężar kamery z uchwytem instalacyjnym.
- Zmiażdżone lub "gole" przewody mogą być przyczyną uszkodzenia urządzenia lub pożaru.
- Ze względów bezpieczeństwa nie należy dopuszczać innych osób w pobliżu miejsca montażu. Na wszelki wypadek należy również odsunąć rzeczy osobiste personelu.

### Zamontuj kamerę na podłodze.

1. Zamontuj cokół na podłodze.

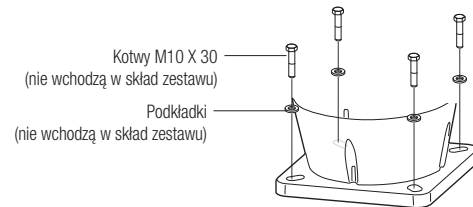

- ! W celu zamontowania kamery na elementach z betonu zalecamy zastosowanie kotew o wymiarach co najmniej M10 X 30.
- Zastosować śruby o wytrzymałości wynoszącej co najmniej czterokrotność masy urządzenia.

### Opcjonalne akcesoria montażowe

W celu ułatwienia montażu można zakupić odpowiednie akcesoria opcjonalne.

#### ▪ Montaż na ścianie przy użyciu uchwyty

1. Przykręć uchwyt do ściany przy użyciu 4 kotew (nie wchodzi w skład zestawu).

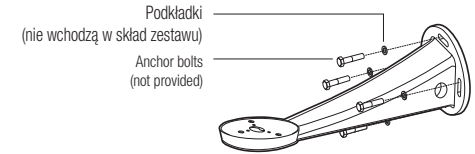

- ! W celu zamontowania kamery na elementach z betonu zalecamy zastosowanie kotew o wymiarach co najmniej M10 X 30.
- Zastosować śruby o wytrzymałości wynoszącej co najmniej czterokrotność masy urządzenia.

2. Pociągnij główny korpus i wspornik za pomocą 3 śrub pod kluczem.

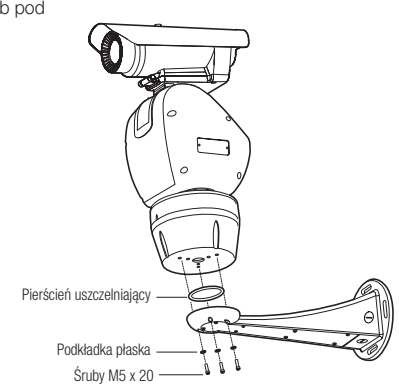

3. Po poprowadzeniu przewodów jak pokazano na ilustracji załóż pokrywę.

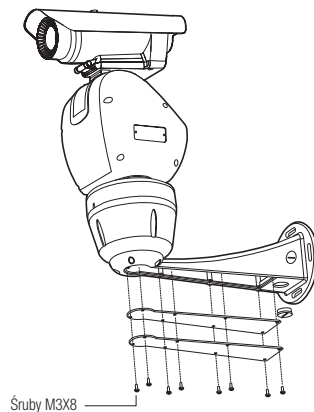

## WKŁADANIE/WYJMOWANIE KARTY PAMIĘCI MICRO SD

- ! ■ Przed włożeniem karty pamięci Micro SD odłącz kabel zasilania od kamery.
- Nie wkładaj na siłę karty pamięci Micro SD, jeśli jest ona ustawiona odwrotnie. Mogłoby to ją uszkodzić.
- W przypadku deszczu lub wysokiej wilgotności wkładanie i wyjmowanie karty Micro SD nie jest zalecane.

### Zdejmowanie osłony karty Micro SD

Użyj klucza torx aby zdjąć osłonę karty Micro SD.

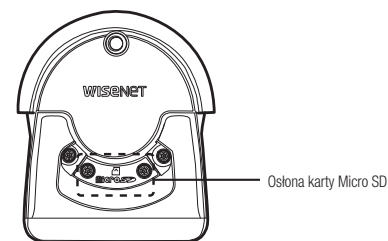

### Wkładanie karty pamięci Micro SD

Umieść kartę Micro SD w kierunku wskazywanym przez strzałkę na rysunku.

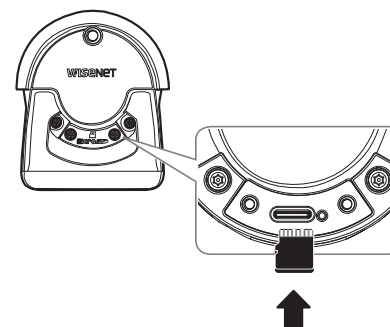

## Wymywanie karty pamięci Micro SD

Aby wysunąć kartę pamięci z gniazda, delikatnie naciśnij wystającą jej część tak, jak to jest widoczne na schemacie.

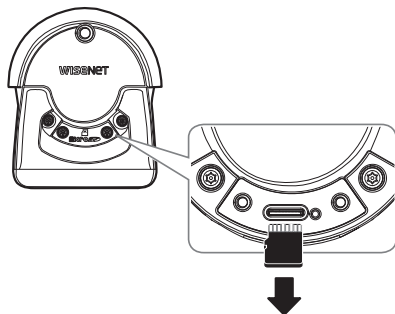

- ! Zbyt mocne naciśnięcie karty pamięci Micro SD może spowodować niekontrolowane wyrzucenie karty ze szczeliny, po jej zwolnieniu.
- Przed wyjęciem karty pamięci Micro SD w obszarze <Pamięć> dla urządzenia wybierz ustawienie <Wytł.>, naciśnij przycisk [Zastosuj] i wyłącz kamerę.
- W przypadku wyłączenia kamery lub wyjęcia karty pamięci Micro SD, która zawiera dane z produktu, dane te mogą ulec utracie lub zniszczeniu.

## INFORMACJE O KARCIE PAMIĘCI (NIEDOŁĄCZONEJ DO ZESTAWU)

### Co to jest karta pamięci?

Karta pamięci jest zewnętrznym urządzeniem do przechowywania danych, które zostało opracowane tak, aby zapewnić całkowicie nowy sposób nagrywania i odtwarzania filmów, muzyki i danych tekstowych za pomocą urządzeń cyfrowych.

### Wybór odpowiedniej karty pamięci

Kamera obsługuje karty pamięci Micro SD/SDHC/SDXC.

Mogą jednak wystąpić problemy z zgodnością, w zależności od modelu i marki karty pamięci.

W przypadku tej kamery zalecane są następujące typy kart pamięci następujących producentów.

- Producent : SanDisk, Transcend
- Rodzina produktów: karty o dużej odporności

Dla tej kamery zalecane jest użycie kart pamięci o pojemności 16 do 256 GB (typ MLC).

Prędkość karty pamięci może wpływać na wydajność odtwarzania.

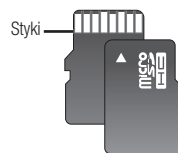

Micro SD/SDHC/SDXC

## PODŁĄCZANIE INNEGO URZĄDZENIA

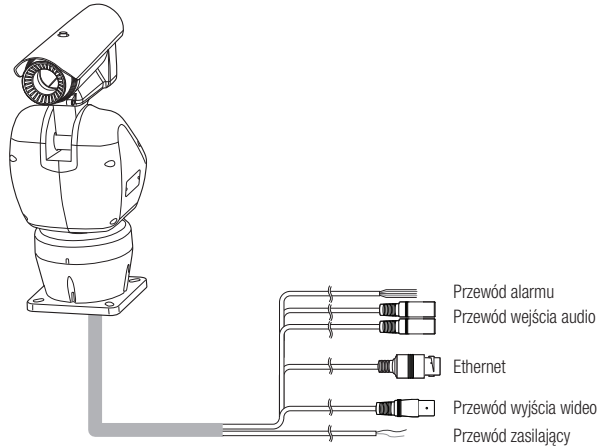

Schemat blokowy wejść i wyjść audio

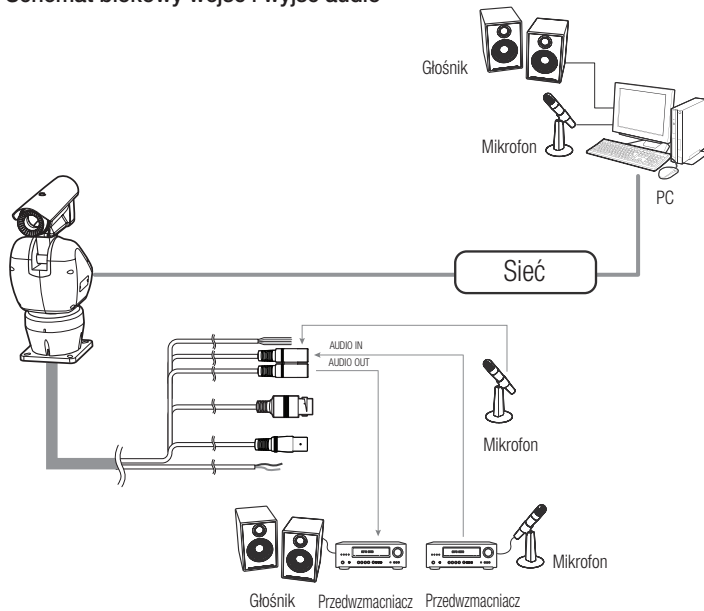

1. Połącz port AUDIO IN kamery bezpośrednio z mikrofonem lub połącz port LINE OUT ze wzmacniaczem, do którego jest podłączony mikrofon.
2. Połącz port AUDIO OUT kamery z portem LINE IN głośnika.
3. Sprawdź informacje o wyjściu audio w danych technicznych.
  - **Kodek Audio** : G.711 PCM,  $\mu$ -law 64kb/s, próbkowanie 8kHz
  - **Dźwięk w trybie pełnego duplexu**
  - **Wejście audio** : Używane jako wejście linii sygnału monofonicznego (Maks. 2,4 Vpp)
  - **Wyjście audio** : Używane jako wyjście linii sygnału monofonicznego (Maks. 2,4 Vpp)
  - **Impedancja wyjścia liniowego** : 600omów

Schemat Przewodów wej./wyj. Alarmu

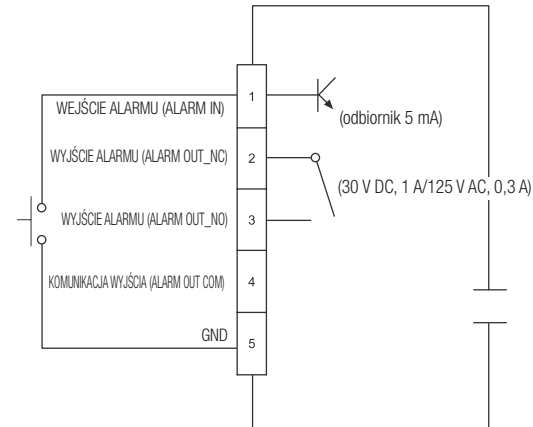

## Sposób połączenia zewnętrznych kabli

Podłączyć kable zewnętrzne, posługując się poniższą tabelą.

- ! Podłączyć wejściowo/wyjściowe kable alarmowe do każdego zacisku po kolei.

Tabliczka znamionowa	KOLOR	Opis	Uwagi
WEJŚCIE ALARMU (ALARM_IN)	Czarny	Gniazdo do podłączenia zewnętrznego sygnału wejścia alarmu	
GND	Brązowy	Gniazdo wspólne (GND) do podłączenia zewnętrznego sygnału wejścia alarmu	
WYJŚCIE ALARMU (ALARM_OUT_NO)	Czerwony	Gniazdo (NO) do podłączenia sygnału wyjściowego przełącznika	
KOMUNIKACJA WYJŚCIA (ALARM_OUT_COM)	Żółty	Gniazdo (GND) do podłączenia sygnału wyjściowego przełącznika	
WYJŚCIE ALARMU (ALARM_OUT_NC)	Pomarańczowy	Gniazdo (NC) do podłączenia sygnału wyjściowego przełącznika	

## Połączenie typu Ethernet

Podłącz kabel Ethernet do sieci lokalnej lub do Internetu.

## Źródło zasilania

Przewód zasilacza podłączyć do gniazda wejściowego zasilania kamery.

Przedmiot	KOLOR
Zasilanie główne	BRĄZOWY
	NIEBIESKI

- ! Upewnić się, czy zasilanie systemu jest wyłączone, podłączając napięcie 24VAC (niepolarne).

## Specyfikacja kabla sieciowego

Przedmiot	Zawartość	Uwagi
Łącze	RJ45	
Ethernet	10/100Base-T	10/100 Mbps
Kabel	UTP Kategoria 5e	
Odległość maks.	100M	

## Specyfikacja kabla zasilania

W przypadku 24 V AC Wejście:

Przewód (AWG)	#16	#14
Długość kabla (Maks.)	15 m	24 m

## Jak podłączyć wodoodporny przewód RJ45 do przewodu sieciowego LAN

1. Wsuń przewód zgodnie z kierunkiem wskazywanym wskazywanym przez strzałkę.

2. Podłącz złącze LAN (męskie) do przewodu.

3. Podłącz wtyczkę modułową RJ45 (żeńską) do złącza RJ45 (męskiego).

! Części muszą być od siebie oddzielone.

4. Dokonaj montażu elementów, obracając wtyczkę modułową RJ45 (żeńską) i osłonę ochronną RJ45 zgodnie z ruchem wskazówek zegara (w kierunku pokazanym przez strzałkę).

5. Dokonaj montażu elementów, obracając pokrywę ochronną RJ45 i pokrywę tylną zgodnie z ruchem wskazówek zegara (w kierunku pokazanym przez strzałkę). Po zakończeniu montażu pokrywy tylnej uszczelka wodoodporna przewodu będzie docisnięta do przewodu, co zapewni jego wodoodporność.

! Aby tylną pokrywę można było do końca nakręcić na gwint śruby złącza RJ45, montaż wszystkich elementów musi być pełny.

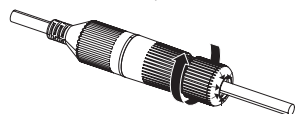
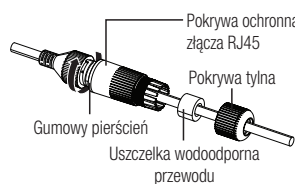
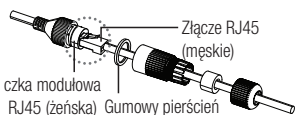
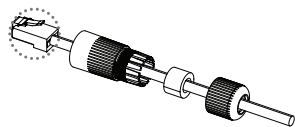
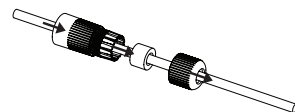

## Montaż na zewnątrz budynku

W przypadku montażu na zewnątrz budynku, kamerę należy uszczelnić wodoszczelną taśmą z kauczuku butylowego dostępną w sklepach, tak aby woda nie dostawała się przez zamocowany na zewnątrz kabel.

1. Podłączyć kable: zasilania, we/wy (I/O), AUDIO oraz LAN.
2. Taśmą wodoszczelną (z kauczuku butylowego) owinąć osłonkę czarnego kabla (Obszar A) oraz obszar złącza kabla, tak aby powstała zakładka szeroka na ponad połowę szerokości użytej taśmy butylowo-kauczukowej.

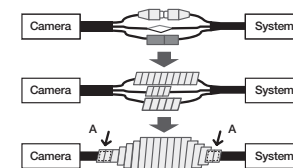

- !
- Jeśli osłonka kabla nie jest właściwie uszczelniona, może to być bezpośrednią przyczyną przecieku. Zapewnić szczelność kabla przez ścisłe owinięcie jego taśmą.
  - Taśma butylowo-kauczukowa jest wykonana z kauczuku butylowego, który można rozciągnąć do jego dwukrotnej pierwotnej długości.
  - Nie ma konieczności owijania taśmą z gumy butylowej osobno, ponieważ kabel złącza LAN jest wodoodporny.

Można skonfigurować ustawienia sieciowe zgodnie z charakterystyką sieci użytkownika.

## PODŁĄCZANIE KAMERY BEZPOŚREDNIO DO SIECI LOKALNEJ

### Podłączanie do kamery lokalnego komputera PC przyłączonego do sieci lokalnej

1. Uruchom na lokalnym komputerze PC przeglądarkę internetową.
2. Na pasku adresu przeglądarki wpisz adres IP kamery.

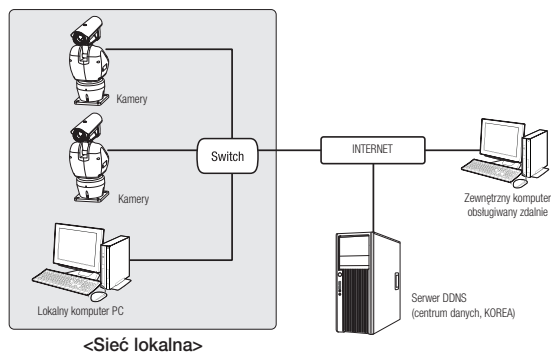

- Zdalny komputer PC podłączony do zewnętrznej sieci Internet poza siecią lokalną może nie połączyć się z kamerą podłączoną do intranetu, jeśli przekazywanie portów nie zostanie prawidłowo ustawione lub gdy działa zaporą. W takim wypadku, aby rozwiązać problem, należy skontaktować się z administratorem sieci.
- W programie Device Manager możesz użyć początkowego hasła, „4321” aby ustawić adres IP, maskę podsieci, bramę, port HTTP, port VNP, typ IP. Po zmianie interfejsu sieciowego, należy wejść na podgląd WEB i zmienić hasło.
- Domyślnym ustawieniem fabrycznym jest automatyczne przydzielanie adresu IP przez serwer DHCP. Jeśli serwer DHCP nie jest dostępny, adres IP zostanie ustawiony na 192.168.1.100. Aby zmienić adres IP, użyj programu Device Manager. Aby uzyskać więcej informacji nt. korzystania z programu Device Manager, patrz „Korzystanie z programu Device Manager”. (Strona 17)

## PODŁĄCZANIE KAMERY BEZPOŚREDNIO DO MODEMU DSL/TELEWIZJI KABLOWEJ OPARTEGO NA PROTOKOLE DHCP

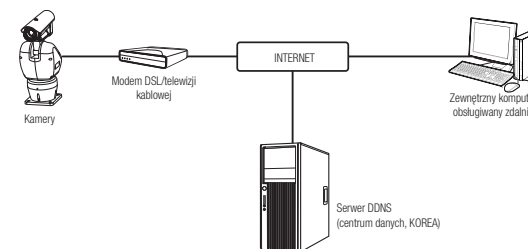

1. Połączenie użytkownika PC bezpośrednio z kamera sieciową.
2. Uruchom program Device Manager i zmierz adres IP kamery, aby móc korzystać z przeglądarki internetowej na pulpicie, aby połączyć się z internetem.
3. Uzyskaj połączenie z przeglądarką Web Viewer za pomocą przeglądarki internetowej.
4. Przejdź do strony [Setup].
5. Przejdź do opcji [Network] – [DDNS] i skonfiguruj ustawienia DDNS.
6. Przejdź do [Basic] – [IP & Port] i ustaw typ IP do [DHCP].
7. Podłącz odłączoną od komputera kamerę, bezpośrednio do modemu.
8. Uruchom kamerę ponownie.

- Informacje na temat sposobu konfiguracji DDNS można znaleźć w systemie pomocy online przeglądarki Web Viewer.
- Informacje na temat sposobu ustawiania formatu IP można znaleźć w systemie pomocy online przeglądarki Web Viewer.

## PODŁĄCZANIE KAMERY BEZPOŚREDNIO DO MODEMU PPPoE

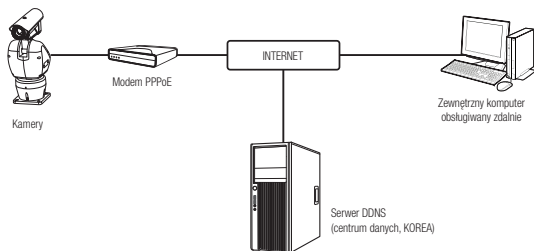

1. Połączenie użytkownika PC bezpośrednio z kamera sieciową.
2. Uruchom program Device Manager i zmień adres IP kamery, aby móc korzystać z przeglądarki internetowej na pulpicie, aby połączyć się z internetem.
3. Uzyskaj połączenie z przeglądarką Web Viewer za pomocą przeglądarki internetowej.
4. Przejdź do strony **[Setup]**.
5. Przejdź do opcji **[Network]** – **[DDNS]** i skonfiguruj ustawienia DDNS.
6. Przejdź do **[Basic]** – **[IP & Port]** Ustaw stronę, ustaw typ IP do **[PPPoE]** i wprowadź ID serwisu sieci wraz z hasłem.
7. Podłącz odłączoną od komputera kamerę, bezpośrednio do modemu.
8. Uruchom kamerę ponownie.

- ✍
  - Informacje na temat sposobu konfiguracji DDNS można znaleźć w systemie pomocy online przeglądarki Web Viewer.
  - Informacje na temat sposobu ustawiania formatu IP można znaleźć w systemie pomocy online przeglądarki Web Viewer.

## PODŁĄCZANIE KAMERY DO RUTER SZEROKOPASMOWY Z MODEMEM PPPoE LUB KABLOWYM

Taki sposób instalacji najlepiej sprawdza się w niewielkich sieciach, np. w domu, małym biurze, biurze domowym albo w sklepie.

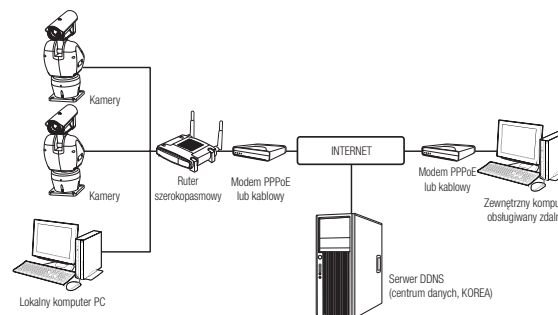

### Konfigurowanie ustawień sieciowych komputera PC lokalnego w stosunku do Ruter szerokopasmowy

W celu skonfigurowania ustawień sieciowych komputera PC lokalnego w stosunku do Ruter szerokopasmowy należy wykonać czynności opisane poniżej.

- Wybierz : <Network> → <Properties> → <Local Area Connection> → <General> → <Properties> → <Internet Protocol (TCP/IP)> → <Properties> → <Obtain an IP address automatically> lub <Use the following IP address>.
- W przypadku wybrania opcji <Use the following IP address> należy wykonać czynności opisane poniżej:
  - Np. 1) Jeśli adres (adres IP w sieci lokalnej) Ruter szerokopasmowy to 192.168.1.1  
 Adres IP : 192.168.1.100  
 Maska podsieci : 255.255.255.0  
 Brama domyślna : 192.168.1.1
  - Np. 2) Jeśli adres (adres IP w sieci lokalnej) Ruter szerokopasmowy to 192.168.0.1  
 Adres IP : 192.168.0.100  
 Maska podsieci : 255.255.255.0  
 Brama domyślna : 192.168.0.1
  - Np. 3) Jeśli adres (adres IP w sieci lokalnej) Ruter szerokopasmowy to 192.168.xxx.1  
 Adres IP : 192.168.xxx.100  
 Maska podsieci : 255.255.255.0  
 Brama domyślna : 192.168.xxx.1
- ✍
  - Aby uzyskać adres Ruter szerokopasmowy, należy y zajrzeć do jego dokumentacji.
  - Aby uzyskać więcej informacji na temat przekierowywania portu routera szerokopasmowego, patrz część "**Konfigurowanie Przekazywania Zakresu Portów (Mapowania Portów)**". (Strona 19)



## KORZYSTANIE Z PROGRAMU DEVICE MANAGER

- Program Device Manager można pobrać z menu <Technical Guides> – <Online Tool> w witrynie Hanwha Techwin (<http://www.hanwha-security.com>).
- Więcej instrukcji programu Device Manager można znaleźć w menu <Pomoc> na stronie głównej.

## AUTOMATYCZNE WYSZUKIWANIE KAMERY

Jeśli kamera jest podłączona do tej samej sieci komputera PC, na którym jest zainstalowany Device Manager, możesz znaleźć kamerę sieciową za pomocą funkcji wyszukiwania.

- Kliknij <Wyszukaj> na stronie głównej programu Device Manager.
- Sprawdź kamerę z listy.
  - Sprawdź adres MAC na naklejce dołączonej do kamery.

## KONFIGUROWANIE ADRESU IP

Jeśli chcesz zmienić ustawienia sieci kamery, znak <Logowanie OK> musi być widoczny w <Status>. Kliknij <Uwierzytelnianie> na stronie głównej, aby się zalogować.

### Konfigurowanie statycznego IP

Ręcznie wstaw i skonfiguruj adres IP i informacje o porcie.

- Kliknij kamerę z listy dla której chcesz zmienić ustawienia IP.
- Kliknij <IP Assign (Przypisz IP)> na stronie głównej programu Device Manager.
- Wybierz <Przypisz następujący adres IP>.
  - Informacje IP kamery zostaną wyświetlone zgodnie z poprzednim ustawieniem.
- Wypełnij kategorie związane z IP & Port.

### Jeżeli nie jest używany Ruter szerokopasmowy

Zapytaj o ustawioną wartość menedżera sieci <Adres IP>, <Maska podsieci>, <Brama>.

- HTTP Port : Umożliwia dostęp do kamery za pomocą przeglądarki internetowej; domyślna wartość to 80.
- VNP Port : Służy do sterowania transmisją sygnału wideo; wartość domyślna to 4520.
- RTSP Port : Port sterujący strumieniowaniem w czasie rzeczywistym. Początkowa wartość to 554.

### Jeżeli używany jest Ruter szerokopasmowy

- IP Address : Wpisz adres mieszczący się w zakresie IP podanym przez Ruter szerokopasmowy.  
Np. 192.168.1.2~254, 192.168.0.2~254, 192.168.XXX.2~254
- Subnet Mask : Opcja <Subnet Mask> Ruter szerokopasmowy będzie także stanowić <Subnet Mask> kamery.
- Gateway : Opcja <Local IP Address> Ruter szerokopasmowy będzie także stanowić <Gateway> kamery.

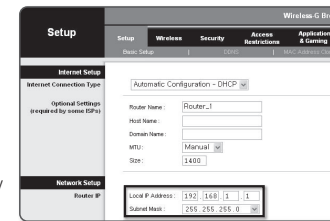

- Ustawienia mogą być różne, w zależności od Ruter szerokopasmowy. Aby uzyskać więcej informacji, patrz instrukcja obsługi odpowiedniego rutera.
- Aby uzyskać więcej informacji na temat przekierowywania portu rutera szerokopasmowego, patrz część "Konfigurowanie Przekazywania Zakresu Portów (Mapowania Portów)". (Strona 19)

### Jeżeli do Ruter szerokopasmowy jest podłączonych więcej niż jedna kamera

Skonfiguruj ustawienia powiązane z adresem IP oraz portem osobno.

Np.

Kategoria		Kamera 1	Kamera 2
Ustawienia związane z IP	IP Address	192.168.1.100	192.168.1.101
	Subnet Mask	255.255.255.0	255.255.255.0
	Gateway	192.168.1.1	192.168.1.1
Ustawienia związane z portem	HTTP Port	8080	8081
	VNP Port	4520	4521
	RTSP Port	554	555

- Jeżeli opcja <HTTP Port> ma inną wartość niż 80, należy podać numer <Port> w pasku adresu przeglądarki internetowej, aby móc uzyskać dostęp do kamery.  
Np. <http://Adres IP: port HTTP>  
<http://192.168.1.100:8080>

- Kliknij przycisk [Zastosuj].
- Jeśli wyświetlona zostanie wiadomość o powodzeniu, kliknij [OK].

## Konfigurowanie dynamicznego IP

Odbierz adres IP z DHCP.

- Przykład środowiska dynamicznego IP
  - Jeżeli do Ruter szerokopasmowy IP z podłączonymi kamerami zostanie przypisany adres IP przez serwer DHCP
  - Jeżeli kamera zostanie podłączona bezpośrednio do xDSL lub modemu kablowego za pomocą protokołów DHCP
  - Jeżeli adresy IP są przypisywane przez wewnętrzny serwer DHCP przez sieć LAN

1. Kliknij kamerę z listy dla której chcesz zmienić ustawienia IP.
2. Kliknij **<IP Assign (Przypisz IP)>** na stronie głównej programu Device Manager.
3. Wybierz **<Uzyskaj adres IP automatycznie (DHCP)>**.
4. Kliknij przycisk **[Zastosuj]**.
5. Jeśli wyświetlona zostanie wiadomość o powodzeniu, kliknij **[OK]**.

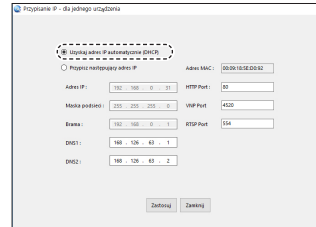

## AUTOMATYCZNA KONFIGURACJA IP

1. Kliknij kamerę z listy dla której chcesz automatycznie skonfigurować IP.
2. Kliknij **<+ >** na głównej stronie programu Device Manager.
  - Pojawi się menu ustawień sprzętu.
3. W menu kliknij **<Auto IP Configure (Auto konfiguracja IP)>**.
4. Kliknij przycisk **[Zamknij]**.

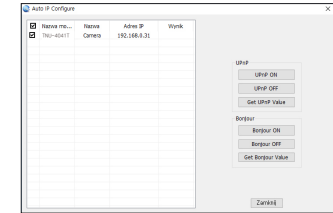

## RĘCZNA REJESTRACJA KAMERY

Jeśli nie można znaleźć kamery za pomocą funkcji wyszukiwania, kamerę można zarejestrować zdalnie, ręcznie wprowadzając informacje o IP, jeśli kamera jest podłączona do sieci zewnętrznej.

1. Kliknij **<Dodaj urządzenia>** – **<Dodaj urządzenie ręcznie>** na stronie głównej programu Device Manager.
2. Wstaw zakres szukanego adresu IP.
3. Wybierz **<Nazwa modelu>** zarejestrowanej kamery i wstaw port HTTP, port VNP, ID oraz hasło.
4. Kliknij przycisk **[Rejestruj]**.
5. Sprawdź, czy kamera jest zarejestrowana.
  - Sprawdź adres MAC na naklejce dołączonej do kamery.

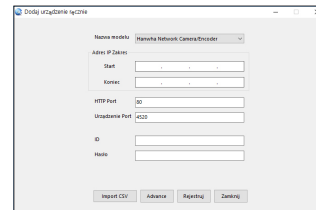

## KONFIGUROWANIE PRZEKAZYWANIA ZAKRESU PORTÓW (MAPOWANIA PORTÓW)

Jeżeli zainstalowany jest Ruter szerokopasmowy z podłączoną kamerą, należy ustawić przekazywanie zakresu portów na Ruter szerokopasmowy, aby zdalny komputer mógł uzyskać dostęp do kamery za jego pośrednictwem.

### Ręczne przekazywanie zakresu portów

1. Z menu Konfiguracja Ruter szerokopasmowy, wybierz opcję <Applications & Gaming> - <Port Range Forward>.

W celu ustawienia przekazywania zakresu portów dla routera innego producenta należy zapoznać się z instrukcją obsługi tego Ruter szerokopasmowy.

2. Wybierz opcję <TCP> oraz <UDP Port> dla każdej kamery podłączonej do Ruter szerokopasmowy.

Numer każdego portu, który ma zostać skonfigurowany do routera IP, należy ustawić zgodnie z numerem portu określonym w menu <Ustawienia> - <Basic> - <IP & Port> w przeglądarce Web Viewer kamery.

3. Po zakończeniu kliknij opcję [Save Settings].

Ustawienia zostaną zapisane.

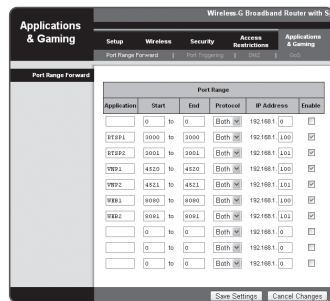



-  ■ Ustawienie przekierowania portu jest przykładem ustawienia routera IP CISCO.
- Ustawienia mogą być różne, w zależności od Ruter szerokopasmowy. Aby uzyskać więcej informacji, patrz instrukcja obsługi odpowiedniego routera.

### Konfigurowanie opcji Przekazywanie zakresu portów dla kilku kamer sieciowych

- Użytkownik może ustawić przekierowanie portu na Ruter szerokopasmowy na stronie internetowej konfiguracji.
- Użytkownik może zmienić każdy port za pomocą ekranu ustawień kamery.

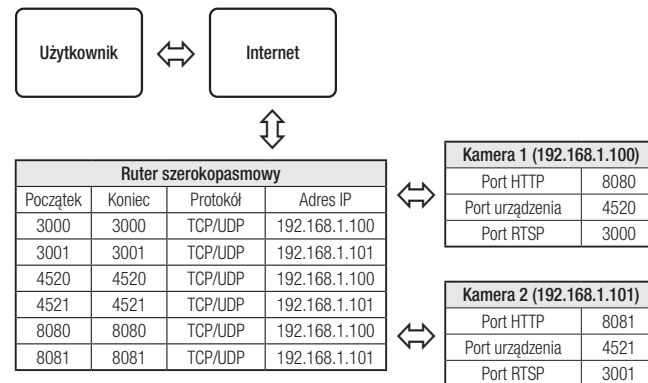
W przypadku podłączenia Kamery 1 i Kamery 2 do routera :



-  ■ Przekierowanie portów może zostać ustawione bez dodatkowych ustawień routera, jeżeli router obsługuje funkcję UPhP (Universal Plug and Play). Po podłączeniu kamery sieciowej zaznacz pole wyboru w menu <Szybkie podłączenie> w oknie <Wlanet DDNS> w "Ustawieniach -> Sieć -> DDNS".

## PODŁĄCZANIE DO KAMERY ZA POMOCĄ UDOSTĘPNIONEGO LOKALNEGO KOMPUTERA

---

1. Uruchom program Device Manager.  
Aplikacja wyszuka podłączone kamery i wyświetli je w postaci listy.
2. Kliknij dwukrotnie kamerę, aby uzyskać do niej dostęp.  
Zostanie uruchomiona przeglądarka internetowa i nastąpi połączenie z kamerą.



- Do kamery można przejść także wpisując adres IP znalezionej kamery w pasku adresu przeglądarki internetowej.

## PODŁĄCZANIE DO KAMERY ZE ZDALNEGO KOMPUTERA PRZEZ INTERNET

---

Na komputerze zdalnym, który nie znajduje się w klastrze sieciowym routera szerokopasmowego, użytkownicy mogą uzyskać dostęp do kamer w sieci routera szerokopasmowego, używając DDNS URL kamery.

1. Aby możliwe było uzyskanie dostępu do kamery w sieci Ruter szerokopasmowy, należy ustawić przekazywanie zakresu portów Ruter szerokopasmowy.
2. Na zdalnym komputerze uruchom przeglądarkę internetową i wpisz adres URL DDNS kamery lub adres Ruter szerokopasmowy szerokopasmowy w pasku adresu.  
Np. <http://ddns.hanwha-security.com/ID>



- Aby korzystać z Wisenet DDNS, zarejestruj się na stronie głównej Wisenet DDNS (<http://ddns.hanwha-security.com>) i zarejestruj produkt w [\[Moje DDNS\]](#)> [\[Zarejestruj Produkt\]](#).

## PODŁĄCZANIE DO KAMERY

### Zazwyczaj należy postępować w następujący sposób

1. Uruchom przeglądarkę internetową.
2. Wpisz adres IP kamery w pasku adresu.
  - np. • Adres IP (IPv4) : 192.168.1.100 → http://192.168.1.100
  - powinno zostać wyświetlone okno dialogowe.
  - Adres IP (IPv6) : 2001:230:abcd:ffff:0000:0000:ffff:1111
  - http://[2001:230:abcd:ffff:0000:0000:ffff:1111] - powinno zostać wyświetlone okno dialogowe.

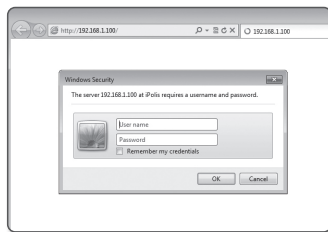

### Jeśli port http jest inny niż 80

1. Uruchom przeglądarkę internetową.
2. Wpisz adres IP i numer portu HTTP kamery w pasku adresu.
  - np. Adres IP : 192.168.1.100:numer portu HTTP (8080)
  - http://192.168.1.100:8080 - powinno zostać wyświetlone okno dialogowe logowania.

### Za pomocą URL

1. Uruchom przeglądarkę internetową.
2. Wpisz adres URL DDNS kamery w pasku adresu.
  - np. Adres URL : https://ddns.hanwha-security.com/ID produktu
  - powinno zostać wyświetlone okno dialogowe logowania.

 ▪ Połączenie sieciowe jest wyłączone w środowisku ograniczonym do LAN.

### Połączenie przez UPnP

1. Uruchomić klienta lub system operacyjny obsługujący protokół UPnP.
2. Aby wyszukać, kliknąć w nazwę kamery.
  - W systemie Windows, kliknąć w nazwę kamery wyszukaną w menu sieciowym.
  - Okno logowania jest otwarte.

### Połączenie przez Bonjour

1. Uruchomić klienta lub system operacyjny obsługujący protokół Bonjour.
2. Aby wyszukać, kliknąć w nazwę kamery.
  - W Mac SO kliknąć w nazwę kamery wyszukaną w zakładce Bonjour na Safari.
  - Okno logowania jest otwarte.

### Sprawdzanie adresu DDNS

Jeśli kamera jest podłączona bezpośrednio do modemu DHCP przez sieć kablową, modemu DSL lub PPPoE, adres IP sieci będzie zmieniany za każdą próbą połączenia z serwerem ISP (ang. Internet Service Provider – dostawca Internetu).

W takim przypadku użytkownik nie będzie informowany o zmianie adresu IP przez DDNS.

Po zarejestrowaniu urządzenia z dynamicznym adresem IP w serwerze DDNS można bezpiecznie sprawdzić zmieniony adres IP podczas uzyskiwania dostępu do urządzenia. Aby zarejestrować urządzenie na serwerze <DDNS>, najpierw wejdź na stronę https://ddns.hanwha-security.com i zarejestruj urządzenie, a następnie dla opcji <Network> - <DDNS> przeglądarki Web Viewer wybierz ustawienie <Wisenet DDNS> oraz podaj <ID produktu> używane do rejestracji DDNS.

## USTAWIENIA HASŁA

Pierwsze użycie produktu wiąże się z koniecznością rejestracji loginu i hasła.

Po pojawieniu się okna "zmiana hasła" wprowadzić nowe hasło.

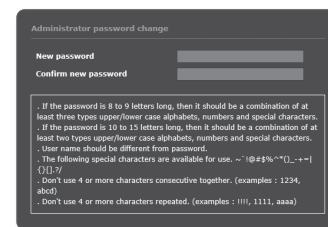

-  ▪ Nowe hasło powinno mieć 8 do 9 znaków długości, w tym 3 znaki wielkie/małe, cyfry i znaki specjalne. Dla hasła 10 do 15 znaków wystarczą 2 znaki wskazane wyżej.
  - Dozwolone znaki specjalne: ~!@#%&^\*()\_+~"{}|.?/[]?/
- Dla poprawy bezpieczeństwa nie zaleca się powtarzania tych samych znaków po kolei ani używania kolejnych znaków klawiatury.
- Jeżeli hasło zostało utracone, nacisnąć przycisk **[RESET]** i inicjować produkt. Zatem hasło należy zapamiętać, lub zapisać.

## LOGOWANIE

Przy każdej próbie uzyskania dostępu do kamery zostanie wyświetlone okno logowania. Wprowadź ID użytkownika i hasło, aby uzyskać dostęp do kamery.

1. Wpisz słowo "admin" w polu <User Name>. ID administratora "admin" jest stałe i nie można go zmienić.
2. Wprowadź hasło w polu <Password>.
3. Kliknij przycisk [OK].  
Jeżeli logowanie się powiodło, zostanie wyświetlony ekran aplikacji Live Viewer.

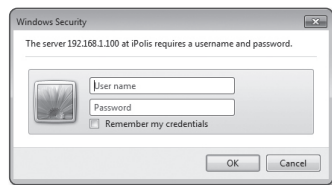

- ! Podczas korzystania z podglądu internetowego należy zwrócić uwagę na bezpieczeństwo i sprawdzić, czy obraz jest szyfrowany.
- ✍ Jeżeli zostanie zaznaczona opcja "Remember my credentials" po wprowadzeniu danych, przy kolejnym uruchomieniu nastąpi automatyczne logowanie bez potrzeby podawania danych logowania.
- Najlepszą jakość wideo można uzyskać przy ekranie o rozmiarze 100%. Zmniejszenie współczynnika może spowodować obcięcie krawędzi obrazu.

## SPECYFIKACJA OBSŁUGI WTYCZEK DLA KAŻDEJ PRZEGLĄDARKI

Istniejąca przeglądarka Web Viewer z wtyczkami oraz nowa przeglądarka Web Viewer wolna od wtyczek są wbudowane razem.

Dzięki temu przeglądarki Web Viewer można używać w środowiskach nowszych przeglądarek, które nie obsługują wtyczek, takich jak Chrome, EDGE lub FireFox (tylko w 64-bitowej wersji Windows). W przypadku przeglądarek umożliwiających instalację wtyczek, takich jak IE i Safari, instalacja wtyczki jest zalecana.

W zależności od środowiska przeglądarki można zaobserwować następujące różnice:

- **Przeglądarki Chrome, FireFox(Obsługiwana wyłącznie w systemie Windows 64bit), EDGE** : Mimo że przeglądarki te nie obsługują wtyczek, wbudowanej przeglądarki Web Viewer można użyć jako przeglądarki Web Viewer wolnej od wtyczek.

- !
  - Przeglądarka WebViewer bez wtyczek ma niższą wydajność niż przeglądarka WebViewer z wtyczkami, w związku z czym obniża limit monitorowania profili wysokiej jakości i odtwarzania zapisanych wideo. Aby monitorować profile wysokiej jakości i odtwarzać zapisane wideo, użyj przeglądarki WebViewer z wtyczkami lub przeglądarki SmartViewer.
    - Warunki obsługi przeglądarki WebViewer w przeglądarce bez wtyczek: wybrany profil przekracza jakość MJPEG Full HD 10 kI./s H.264 (Chrome: obsługa rozdzielczości w trybie pełnego ekranu / Edge, Firefox, Safari: obsługa rozdzielczości Full HD 30 kI./s lub wyższej) H.265 Full HD 10 kI./s 2 Mb/s lub wyższa
    - Warunki odtwarzania bez wtyczek: rozdzielczość w trybie pełnego ekranu MJPEG/H.264, H.265 HD lub niższa
  - Obsługa funkcji bez wtyczek została zoptymalizowana pod kątem przeglądarki Chrome.
  - Obsługa adaptacyjnej transmisji strumieniowej
    - Funkcja ta automatycznie obniża profil w przypadku wystąpienia opóźnienia przekraczającego 5 sekund. Została opracowana w celu wyeliminowania takich problemów, jak wzrost czasu oczekiwania i brak odpowiedzi przeglądarki podczas odtwarzania wideo w systemie o parametrach sprzętowych niższych niż zalecane. Profil wideo zostaje redukowany w następującej kolejności: 1920X1080(20fps) -> 1280X720(20fps) -> 640X480(20fps).

- **Przeglądarki IE, Safari** : Przeglądarki Web Viewer można używać nawet bez instalowania istniejącej przeglądarki Web Viewer z wtyczkami.

- !
  - Do płynnego monitorowania/odtwarzania zapisanego wideo wymagana jest instalacja wtyczki.

## INSTALACJA DODATKU WebViewer

Aby uzyskać dostęp do przeglądarki, pojawi się komunikat z zapytaniem o wtyczkę przeglądarki wideo na żywo (H.264/H.265) lub odtwarzania zarejestrowanego filmu. Wtedy należy zainstalować wtyczkę przeglądarki, aby ta funkcja mogła działać w sposób prawidłowy.

1. Podczas pierwszego wejścia na stronę monitoringu, wyświetlana jest strona instalacji. Aby rozpocząć instalację, kliknąć w [Download plugin].
- !
  - Jeżeli w Internet Explorer status pobierania pliku do instalacji wtyczki jest zawieszony po osiągnięciu na 99%, powtórzyć operację po wybraniu "Wyłącz filtr Smart Screen" w "Narzędzia → Filtr Smart Screen".
2. Kliknąć w [Run] na oknie dialogowym.
3. Kliknąć [Yes] na oknie dialogowym zawierającym komunikat, że wszystkie okna przeglądarki zostaną zamknięte.
- ✍
  - Kroki 4 i 5 mogą zostać pominięte, jeżeli nie zainstalowano wtyczek Web Viewer.
4. Gdy zainstalowana jest stara wersja wtyczki Web Viewer, ukaże się okno z komunikatem, że stara wersja zostanie usunięta. Kliknąć [Yes] na oknie dialogowym.
5. Kliknąć [OK].  
Poprzednia wersja wtyczki Web Viewer została usunięta.
6. Kliknąć [Install] aby rozpocząć instalację wtyczki Web Viewer.
7. Kliknąć [Finish].  
Instalacja wtyczki Web Viewer jest zakończona.
- !
  - W IE, po zainstalowaniu wtyczki, należy sprawdzić czy kontrolka wtyczki webviewer\_activex w menu "Narzędzia → Dodatkowe Funkcje Zarządzania" jest "Aktywowana". Jeśli nie, a problem nadal występuje, wybrać "Narzędzia → Opcje Internetowe → Ogólne" i usunąć wszystkie wyszukane rekordy. Jeśli problem będzie występował nadal, zarejestruj adres IP lub domenę swojej kamery w menu „Narzędzia → Opcje internetowe → Zabezpieczenia → Zaufane witryny”.

## UŻYTKOWANIE BEZPŁATNEJ WTYCZKI PRZEGLĄDARKI

Mimo że nie można zainstalować wtyczek osobno, po uzyskaniu dostępu do kamery za pośrednictwem przeglądarki WWW Google Chrome, Mozilla Firefox lub MS Edge obraz z kamery można wyświetlać i sterować nim bez konieczności instalowania wtyczek.

1. W celu zalogowania się podaj swoją nazwę użytkownika i hasło.
2. Po zalogowaniu się wyświetlony zostanie ekran z widokiem na żywo z kamery.

### Ustawianie kamery

1. Kliknij ikonę [Ustawienia (⚙)].
2. Wyświetlone zostanie okno Ustawienia.
3. Umożliwia ono zarządzanie za pośrednictwem sieci ustawieniami dotyczącymi podstawowych informacji o kamerze, PTZ, wideo i dźwięku, sieci, zdarzeń, analizy, systemu i platformy otwartej.
4. Kliknij opcję <Pomoc (🔗)>, aby wyświetlić szczegółowy opis każdej funkcji.

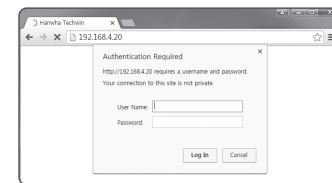

## ROZWIĄZYWANIE PROBLEMÓW

PROBLEM	ROZWIĄZANIE
Jeśli użytkownik systemu Windows 10 uzyska dostęp do przeglądarki Web Viewer za pośrednictwem przeglądarki Chrome lub Firefox, ustawienie głośności mikrofonu zmienia się cyklicznie.	<ul style="list-style-type: none"> <li>Taka sytuacja występuje po wybraniu sterownika Realtek jako sterownika mikrofonu. Jako sterownik mikrofonu zainstaluj sterownik urządzenia dźwięku w wysokiej rozdzielczości (domyślny sterownik systemu Windows) lub sterownik innego producenta.</li> </ul>
Nie wyświetli się żadne wideo poprzez dostęp do bezpłatnej przeglądarki na Safari poprzez HTTPS.	<ul style="list-style-type: none"> <li>W oknie uwierzytelniania wyświetlonym przy pierwszym dostępie do protokołu https kliknij opcję „Pokaż certyfikat uwierzytelnienia” i zaznacz pole wyboru „Zawsze ufaj, nawiązując połączenie do określonego IP przeglądarki WebViewer”.</li> <li>Jeśli przeglądarka nadal odmawia wyświetlania wideo po wyborze "Następny" w poniższym oknie komunikatów, należy nacisnąć klawisz polecenia + Q w celu opuszczenia przeglądarki Safari, uzyskać ponowny dostęp i wykonać podane wyżej procedury.</li> </ul>
Nie można sterować systemem.	<ul style="list-style-type: none"> <li>Sprawdź zasilanie. Upewnij się, czy zasilanie jest włączone.</li> <li>Sprawdź, czy jest podłączony kabel komunikacyjny.</li> </ul>
Nie mogę uzyskać dostępu do kamery z przeglądarki internetowej.	<ul style="list-style-type: none"> <li>Sprawdź, czy ustawienia sieciowe kamery są odpowiednie.</li> <li>Sprawdź, czy wszystkie kable sieciowe zostały podłączone prawidłowo.</li> <li>W przypadku łączenia za pomocą DHCP sprawdź, czy kamera otrzymała dynamiczny adres IP.</li> <li>Jeśli kamera jest podłączona do Ruter szerokopasmowy, sprawdź, czy przekazywanie portów zostało skonfigurowane prawidłowo.</li> </ul>
Program podglądu został odłączony podczas monitorowania.	<ul style="list-style-type: none"> <li>Podłączone programy podglądu zostają odłączone przy każdej zmianie konfiguracji kamery lub sieci.</li> <li>Sprawdź wszystkie połączenia sieciowe.</li> <li>Jeśli kamera jest podłączona przez sieć PPPoE, możliwe jest odłączenie programu podglądu w przypadku pogorszenia warunków działania sieci.</li> </ul>
Nie mogę się połączyć z systemem, korzystając z przeglądarki Internet Explorer 7.0 z obsługą kart.	<ul style="list-style-type: none"> <li>Może pojawić się błąd przy łączeniu z nowym oknem lub zakładką, z powodu dzielenia danych cookie. Nie używać nowego okna czy zakładki, wybrać "Plik → Nowa sesja”.</li> </ul>
Kamera podłączona do sieci nie jest wykrywana w programie Device Manager.	<ul style="list-style-type: none"> <li>Wyłącz cz zaporę na komputerze PC i wyszukaj kamery ponownie.</li> </ul>
Obrazy nakładają się na siebie.	<ul style="list-style-type: none"> <li>Sprawdź, czy kilka kamer nie jest ustawionych na ten sam adres multiemisji. Jeśli jest używany ten sam adres przez wiele kamer, obrazy mogą się na siebie nakładać.</li> </ul>
Brak obrazu.	<ul style="list-style-type: none"> <li>Jeśli metoda transmisji to multiemisja, sprawdź, czy router w sieci lokalnej, do którego jest podłączona kamera, obsługuje multiemisję.</li> </ul>

PROBLEM	ROZWIĄZANIE
Głos nie został nagrany pomimo skonfigurowania ustawień wejścia audio.	<ul style="list-style-type: none"> <li>Zaznacz pole wyboru &lt;Wejście audio&gt; w menu &lt;Podstawowy&gt; - &lt;Profil wideo&gt;.</li> </ul>
<Wykrywanie ruchu> z <Analizy> jest w pozycji <Włącz.>, ale nie otrzymuję zawiadomień email nawet jeżeli nastąpiło zdarzenie ruchu.	<ul style="list-style-type: none"> <li>Sprawdź ustawienia w następującej kolejności: <ul style="list-style-type: none"> <li>A. Sprawdź ustawienia opcji &lt;Data i godzina&gt;.</li> <li>B. Dla opcji &lt;Wykrywanie ruchu&gt; powinno być wybrane ustawienie &lt;Włącz.&gt;.</li> <li>C. Zaznacz, jeśli wybrano użycie opcji &lt;E-mail&gt; w menu &lt;Konfig. zdarzeń&gt;.</li> </ul> </li> </ul>
Czy mogę określić zasady zdarzeń, nawet bez używania opcji <MD / VA>?	<ul style="list-style-type: none"> <li>Tak, można. Można ustawić zasady zdarzeń niezależnie od ustawień inteligentnej analizy obrazu wideo.</li> </ul>
W porcie wyjścia alarmu nie wykryto żadnego sygnału nawet podczas przeprowadzania inteligentnej analizy obrazu wideo.	<ul style="list-style-type: none"> <li>Sprawdź ustawienia portu wyjścia alarmu.</li> </ul>
Nagrywanie na karcie pamięci Micro SD jest niemożliwe.	<ul style="list-style-type: none"> <li>Sprawdź, czy karta pamięci nie jest uszkodzona.</li> </ul>
Karta pamięci Micro SD jest włożona, jednak kamera nie działa prawidłowo.	<ul style="list-style-type: none"> <li>Sprawdź, czy karta pamięci została włożona odpowiednią stroną. Ta kamera nie gwarantuje działania karty pamięci sformatowanej w innych urządzeniach</li> <li>Sformatuj kartę pamięci ponownie w menu &lt;Setup&gt; → &lt;Event&gt; → &lt;Nagrywaj&gt;.</li> </ul>
Nie można nagrywać w NAS.	<ul style="list-style-type: none"> <li>Upewnij się, że informacja rejestrowana w NAS jest poprawna.</li> </ul>
Raportuje że ustawienia NAS nie powiodły się.	<ul style="list-style-type: none"> <li>Upewnij się, że adres IP NAS jest poprawny.</li> <li>Upewnij się, że ID/hasło NAS są poprawne.</li> <li>Korzystając z ID NAS, upewnij się, że jest dostęp do folderu wskazanego jako podstawowy.</li> <li>Upewnij się, że SMB/CIFS nie są zaznaczone.</li> <li>Upewnij się, że adres IP NAS oraz adres IP kamery mają taki sam format. (np.) Początkowa wartość maski podsieci i kamery wynosi 255.255.255.0. Jeżeli adres IP jest 192.168.20.32 adres IP NAS IP powinien zawierać się w 192.168.20.1~192.168.20.255.</li> <li>Sprawdź czy podejmowałeś próbę dostępu jako inny użytkownik bez formatowania zapisanego bądź używanego podstawowego folderu.</li> <li>Upewnij się, że wykorzystywany jest zalecany sprzęt NAS.</li> </ul>

# OPEN SOURCE ANNOUNCEMENT

## GPL/LGPL software license

The software included in this product contains copyrighted software that is licensed under the GPL/LGPL. You may obtain the complete Corresponding Source code from us for a period of three years after our last shipment of this product by sending email to [help.cctv@hanwha.com](mailto:help.cctv@hanwha.com)

If you want to obtain the complete Corresponding Source code in the physical medium such as CD-ROM, the cost of physically performing source distribution might be charged.

### GPL SW

Component Name	License	URL
Base Kernel	GPL 3.0	
Busybox	GPL 2.0	<a href="http://www.busybox.net/downloads/snapshots">http://www.busybox.net/downloads/snapshots</a>
iproute2-3.1.0	GPL 2.0	
alsa-utils-1.0.24.2	GPL 2.0	
alsa-lib-1.0.24.1	GPL 2.0	
iptables-1.4.12.2	GPL 2.0	<a href="http://ftp.netfilter.org/pub/iptables">http://ftp.netfilter.org/pub/iptables</a>
ethtool-3.2	GPL 2.0	
mtd-1.4.1	GPL 2.0	<a href="ftp://ftp.infradead.org/pub/mtd-utils">ftp://ftp.infradead.org/pub/mtd-utils</a>
mi-diag-2.11	GPL 2.0	
rp-pppoe-3.10	GPL 2.0	<a href="http://www.roaringpenguin.com/pppoe/">http://www.roaringpenguin.com/pppoe/</a>
wpa_supplicant-0.7.3	GPL 2.0	
bash-4.2	GPL 3.0	
zeroconf	GPL 2.0	

### LGPL SW

Component Name	License	URL
glibc	LGPL 2.0	
Inetutils	LGPL 3.0	
neon-0.29.6	LGPL 2.0 (The Manual and test suite are GPL)	<a href="http://www.webdav.org/neon/">http://www.webdav.org/neon/</a>

## GNU GENERAL PUBLIC LICENSE

Version 2, June 1991

Copyright (C) 1989, 1991 Free Software Foundation, Inc. 51 Franklin Street, Fifth Floor, Boston, MA 02110-1301, USA

Everyone is permitted to copy and distribute verbatim copies of this license document, but changing it is not allowed.

### Preamble

The licenses for most software are designed to take away your freedom to share and change it. By contrast, the GNU General Public License is intended to guarantee your freedom to share and change free software—to make sure the software is free for all its users. This General Public License applies to most of the Free Software Foundation's software and to any other program whose authors commit to using it. (Some other Free Software Foundation software is covered by the GNU Lesser General Public License instead.) You can apply it to your programs, too. When we speak of free software, we are referring to freedom, not price. Our General Public Licenses are designed to make sure that you have the freedom to distribute copies of free software (and charge for this service if you wish), that you receive source code or can get it if you want it, that you can change the software or use pieces of it in new free programs; and that you know you can do these things.

To protect your rights, we need to make restrictions that forbid anyone to deny you these rights or to ask you to surrender the rights. These restrictions translate to certain responsibilities for you if you distribute copies of the software, or if you modify it.

For example, if you distribute copies of such a program, whether gratis or for a fee, you must give the recipients all the rights that you have.

You must make sure that they, too, receive or can get the source code. And you must show them these terms so they know their rights. We protect your rights with two steps:

(1) copyright the software, and (2) offer you this license which gives you legal permission to copy, distribute and/or modify the software. Also, for each author's protection and ours, we want to make certain that everyone understands that there is no warranty for this free software. If the software is modified by someone else and passed on, we want its recipients to know that what they have is not the original, so that any problems introduced by others will not reflect on the original authors' reputations.

Finally, any free program is threatened constantly by software patents. We wish to avoid the danger that redistributors of a free program will individually obtain patent licenses, in effect making the program proprietary. To prevent this, we have made it clear that any patent must be licensed for everyone's free use or not licensed at all. The precise terms and conditions for copying, distribution and modification follow.

### TERMS AND CONDITIONS FOR COPYING, DISTRIBUTION AND MODIFICATION

Version 2, June 1991 Copyright (C) 1989, 1991 Free Software Foundation, Inc. 51 Franklin St

0. This License applies to any program or other work which contains a notice placed by the copyright holder saying it may be distributed under the terms of this General Public License.

The "Program", below, refers to any such program or work, and a "work based on the Program" means either the Program or any derivative work under copyright law: that is to say, a work containing the Program or a portion of it, either verbatim or with modifications and/or translated into another language. (Hereinafter, translation is included without limitation in the term "modification".) Each licensee is addressed as "you".

Activities other than copying, distribution and modification are not covered by this License; they are outside its scope. The act of running the Program is not restricted, and the output from the Program is covered only if its contents constitute a work based on the Program (independent of having been made by running the Program). Whether that is true depends on what the Program does.

1. You may copy and distribute verbatim copies of the Program's source code as you receive it, in any medium, provided that you conspicuously and appropriately publish on each copy an appropriate copyright notice and disclaimer of warranty; keep intact all the notices that refer to this License and to the absence of any warranty; and give any other recipients of the Program a copy of this License along with the Program. You may charge a fee for the physical act of transferring a copy, and you may at your option offer warranty protection in exchange for a fee.

2. You may modify your copy or copies of the Program or any portion of it, thus forming a work based on the Program, and copy and distribute such modifications or work under the terms of Section 1 above, provided that you also meet all of these conditions:

- You must cause the modified files to carry prominent notices stating that you changed the files and the date of any change.
- You must cause any work that you distribute or publish, that in whole or in part contains or is derived from the Program or any part thereof, to be licensed as a whole at no charge to all third parties under the terms of this License.
- If the modified program normally reads commands interactively when run, you must cause it, when started running for such interactive use in the most ordinary way, to print or display an announcement including an appropriate copyright notice and a notice that there is no warranty (or else, saying that you provide a warranty) and that users may redistribute the program under these conditions, and telling the user how to view a copy of this License. (Exception: if the Program itself is interactive but does not normally print such an announcement, your work based on the Program is not required to print an announcement.)

These requirements apply to the modified work as a whole. If identifiable sections of that work are not derived from the Program, and can be reasonably considered independent and separate works in themselves, then this License, and its terms, do not apply to those sections when you distribute them as separate works. But when you distribute the same sections as part of a whole which is a work based on the Program, the distribution of the whole must be on the terms of this License, whose permissions for other licensees extend to the entire whole, and thus to each and every part regardless of who wrote it.

Thus, it is not the intent of this section to claim rights or contest your rights to work written entirely by you; rather, the intent is to exercise the right to control the distribution of derivative or collective works based on the Program. In addition, mere aggregation of another work not based on the Program with the Program (or with a work based on the Program) on a volume of a storage or distribution medium does not bring the other work under the scope of this License.

3. You may copy and distribute the Program (or a work based on it, under Section 2) in object code or executable form under the terms of Sections 1 and 2 above provided that you also do one of the following:

- Accompany it with the complete corresponding machine-readable source code, which must be distributed under the terms of Sections 1 and 2 above on a medium customarily used for software interchange; or,
- Accompany it with a written offer, valid for at least three years, to give any third party, for a charge no more than your cost of physically performing source distribution, a complete machine-readable copy of the corresponding source code, to be distributed under the terms of Sections 1 and 2 above on a medium customarily used for software interchange; or,
- Accompany it with the information you received as to the offer to distribute corresponding source code. (This alternative is allowed only for noncommercial distribution and only if you received the program in object code or executable form with such an offer, in accord with Subsection b above.) The source code for a work means the preferred form of the work for making modifications to it. For an executable work, complete source code means all the source code for all modules it contains, plus any associated interface definition files, plus the scripts used to control compilation and installation of the executable. However, as a special exception, the source code distributed need not include anything that is normally distributed (in either source or binary form) with the major



components (compiler, kernel, and so on) of the operating system on which the executable runs, unless that component itself accompanies the executable. If distribution of executable or object code is made by offering access to copy from a designated place, then offering equivalent access to copy the source code from the same place counts as distribution of the source code, even though third parties are not compelled to copy the source along with the object code.

4. You may not copy, modify, sublicense, or distribute the Program except as expressly provided under this License. Any attempt otherwise to copy, modify, sublicense or distribute the Program is void, and will automatically terminate your rights under this License.

However, parties who have received copies, or rights, from you under this License will not have their licenses terminated so long as such parties remain in full compliance.

5. You are not required to accept this License, since you have not signed it. However, nothing else grants you permission to modify or distribute the Program or its derivative works.

These actions are prohibited by law if you do not accept this License. Therefore, by modifying or distributing the Program (or any work based on the Program), you indicate your acceptance of this License to do so, and all its terms and conditions for copying, distributing or modifying the Program or works based on it.

6. Each time you redistribute the Program (or any work based on the Program), the recipient automatically receives a license from the original licensor to copy, distribute or modify the Program subject to these terms and conditions. You may not impose any further restrictions on the recipients' exercise of the rights granted herein. You are not responsible for enforcing compliance by third parties to this License.

7. If, as a consequence of a court judgment or allegation of patent infringement or for any other reason (not limited to patent issues), conditions are imposed on you (whether by court order, agreement or otherwise) that contradict the conditions of this License, they do not excuse you from the conditions of this License. If you cannot distribute so as to satisfy simultaneously your obligations under this License and any other pertinent obligations, then as a consequence you may not distribute the Program at all.

For example, if a patent license would not permit royalty-free redistribution of the Program by all those who receive copies directly or indirectly through you, then the only way you could satisfy both it and this License would be to refrain entirely from distribution of the Program.

If any portion of this section is held invalid or unenforceable under any particular circumstance, the balance of the section is intended to apply and the section as a whole is intended to apply in other circumstances. It is not the purpose of this section to induce you to infringe any patents or other property right claims or to contest validity of any such claims; this section has the sole purpose of protecting the integrity of the free software distribution system, which is implemented by public license practices. Many people have made generous contributions to the wide range of software distributed through that system in reliance on consistent application of that system; it is up to the author/donor to decide if he or she is willing to distribute software through any other system and a licensee cannot impose that choice. This section is intended to make thoroughly clear what is believed to be a consequence of the rest of this License.

8. If the distribution and/or use of the Program is restricted in certain countries either by patents or by copyrighted interfaces, the original copyright holder who places the Program under this License may add an explicit geographical distribution limitation excluding those countries, so that distribution is permitted only in or among countries not thus excluded. In such case, this License incorporates the limitation as if written in the body of this License.

9. The Free Software Foundation may publish revised and/or new versions of the General Public License from time to time. Such new versions will be similar in spirit to the present version, but may differ in detail to address new problems or concerns. Each version is given a distinguishing version number. If the Program specifies a version number of this License which applies to it and "any later version", you have the option of following the terms and conditions either of that version or of any later version published by the Free Software Foundation. If the Program does not specify a version number of this License, you may choose any version ever published by the Free Software Foundation.

10. If you wish to incorporate parts of the Program into other free programs whose distribution conditions are different, write to the author to ask for permission. For software which is copyrighted by the Free Software Foundation, write to the Free Software Foundation; we sometimes make exceptions for this. Our decision will be guided by the two goals of preserving the free status of all derivatives of our free software and of promoting the sharing and reuse of software generally.

## NO WARRANTY

11. BECAUSE THE PROGRAM IS LICENSED FREE OF CHARGE, THERE IS NO WARRANTY FOR THE PROGRAM, TO THE EXTENT PERMITTED BY APPLICABLE LAW. EXCEPT WHEN OTHERWISE STATED IN WRITING THE COPYRIGHT HOLDERS AND/OR OTHER PARTIES PROVIDE THE PROGRAM "AS IS" WITHOUT WARRANTY OF ANY KIND, EITHER EXPRESSED OR IMPLIED, INCLUDING, BUT NOT LIMITED TO, THE IMPLIED WARRANTIES OF MERCHANTABILITY AND FITNESS FOR A PARTICULAR PURPOSE. THE ENTIRE RISK AS TO THE QUALITY AND PERFORMANCE OF THE PROGRAM IS WITH YOU. SHOULD THE PROGRAM PROVE DEFECTIVE, YOU ASSUME THE COST OF ALL NECESSARY SERVICING, REPAIR OR CORRECTION.

12. IN NO EVENT UNLESS REQUIRED BY APPLICABLE LAW OR AGREED TO IN WRITING WILL ANY COPYRIGHT HOLDER, OR ANY OTHER PARTY WHO MAY MODIFY AND/OR REDISTRIBUTE DAMAGES, INCLUDING ANY GENERAL, SPECIAL, INCIDENTAL OR CONSEQUENTIAL DAMAGES ARISING OUT OF THE USE OR THE PROGRAM (INCLUDING BUT NOT LIMITED TO LOSS OF DATA OR DATA BEING RENDERED INACCURATE OR LOSSES SUSTAINED BY YOU OR THIRD PARTIES OR A FAILURE OF THE PROGRAM TO OPERATE WITH ANY OTHER PROGRAMS), EVEN IF SUCH HOLDER OR OTHER PARTY HAS BEEN ADVISED OF THE POSSIBILITY OF SUCH DAMAGES.

## END OF TERMS AND CONDITIONS

How to Apply These Terms to Your New Programs If you develop a new program, and you want it to be of the greatest possible use to the public, the best way to achieve this is to make it free software which everyone can redistribute and change under these terms. To do so, attach the following notices to the program. It is safest to attach them to the start of each source file to most effectively convey the exclusion of warranty; and each file should have at least the "copyright" line and a pointer to where the full notice is found. One line to give the program's name and an idea of what it does.

Copyright (C)yyyy name of author

This program is free software; you can redistribute it and/or modify it under the terms of the GNU General Public License as published by the Free Software Foundation; either version 2 of the License, or (at your option) any later version.

This program is distributed in the hope that it will be useful, but WITHOUT ANY WARRANTY; without even the implied warranty of MERCHANTABILITY or FITNESS FOR A PARTICULAR PURPOSE. See the GNU General Public License for more details.

You should have received a copy of the GNU General Public License along with this program; if not, write to the Free Software Foundation, Inc., 51 Franklin Street, Fifth Floor, Boston, MA 02110-1301, USA.

Also add information on how to contact you by electronic and paper mail. If the program is interactive, make it output a short notice like this when it starts in an interactive mode:

Gnomovision version 69, Copyright (C) year name of author Gnomovision comes with ABSOLUTELY NO WARRANTY; for details type 'show w'. This is free software, and you are welcome to redistribute it under certain conditions; type 'show c' for details.

The hypothetical commands 'show w' and 'show c' should show the appropriate parts of the General Public License. Of course, the commands you use may be called something other than 'show w' and 'show c'; they could even be mouse-clicks or menu items - whatever suits your program.

You should also get your employer (if you work as a programmer) or your school, if any, to sign a "copyright disclaimer" for the program, if necessary. Here is a sample; alter the names:

Yooyodny, Inc., hereby disclaims all copyright interest in the program 'Gnomovision' (which makes passes at compilers) written by James Hacker. signature of Ty Coon, 1 April 1989 Ty Coon, President of Vice This General Public License does not permit incorporating your program into proprietary programs. If your program is a subroutine library, you may consider it more useful to permit linking proprietary applications with the library. If this is Luwihcaetn ysoeu want to do, use the GNU Lesser General Public instead of this License.

## GNU GENERAL PUBLIC LICENSE

Version 3, 29 June 2007

Copyright (C) 2007 Free Software Foundation, Inc. <<http://fsf.org/>>

Everyone is permitted to copy and distribute verbatim copies of this license document, but changing it is not allowed.

### Preamble

The GNU General Public License is a free, copyleft license for software and other kinds of works. The licenses for most software and other practical works are designed to take away your freedom to share and change the works. By contrast, the GNU General Public License is intended to guarantee your freedom to share and change all versions of a program--to make sure it remains free software for all its users.

We, the Free Software Foundation, use the GNU General Public License for most of our software; it applies also to any other work released this way by its authors.

You can apply it to your programs, too. When we speak of free software, we are referring to freedom, not price. Our General Public Licenses are designed to make sure that you have the freedom to distribute copies of free software (and charge for them if you wish), that you receive source code or can get it if you want it, that you can change the software or use pieces of it in new free programs, and that you know you can do these things.

To protect your rights, we need to prevent others from denying you these rights or asking you to surrender the rights. Therefore, you have certain responsibilities if you distribute copies of the software, or if you modify it: responsibilities to respect the freedom of others. For example, if you distribute copies of such a program, whether gratis or for a fee, you must pass on to the recipients the same freedoms that you received. You must make sure that they, too, receive or can get the source code. And you must show them these terms so they know their rights. Developers that use the GNU GPL protect your rights with two steps: (1) assert copyright on the software, and (2) offer you this License giving you legal permission to copy, distribute and/or modify it. For the developers' and authors' protection, the GPL clearly explains that there is noarranty for this free software. For both users' and authors' sake, the GPL requires that modified versions be marked as changed, so that their problems will not be attributed erroneously to authors of previous versions. Some devices are designed to deny users access to install or run modified versions of the software inside them, although the manufacturer can do so. This is fundamentally incompatible with the aim of protecting users' freedom to change the software. The systematic pattern of such abuse occurs in the area of products for individuals to use, which is precisely where it is most unacceptable. Therefore, we have designed this version of the GPL to prohibit the practice for those products. If such problems arise substantially in other domains, we stand ready to extend this provision to those domains in future versions of the GPL, as needed to protect the freedom of users.

Finally, every program is threatened constantly by software patents. States should not allow patents to restrict development and use of software on general-purpose computers, but in those that do, we wish to avoid the special anger that patents applied to a free program could make it effectively proprietary. To prevent this, the GPL assures that patents cannot be used to render the program non-free. he precise terms and conditions for copying, distribution and modification follow.

## TERMS AND CONDITIONS

### 0. Definitions.

"This License" refers to version 3 of the GNU General Public License.

Copyright" also means copyright-like laws that apply to other kinds of works, such as semiconductor masks. "The Program" refers to any copyrightable work licensed under this License. Each licensee is addressed as "you". "Licensees" and "recipients" may be individuals or organizations.

To "modify" a work means to copy from or adapt all or part of the work in a fashion requiring copyright permission, other than the making of an exact copy. The resulting work is called a "modified version" of the earlier work or a work "based on" the earlier work.

A "covered work" means either the unmodified Program or a work based on the Program.

To "propagate" a work means to do anything with it that, without permission, would make you directly or secondarily liable for infringement under applicable copyright law, except executing it on a computer or modifying a private copy.

Propagation includes copying, distribution (with or without modification), making available to the public, and in some countries other activities as well.

To "convey" a work means any kind of propagation that enables other parties to make or receive copies. Mere interaction with a user through a computer network, with no transfer of a copy, is not conveying. An interactive user interface displays "Appropriate Legal Notices" to the extent that it includes a convenient and prominently visible feature that (1) displays an appropriate copyright notice, and (2) tells the user that there is no warranty for the work (except to the extent that warranties are provided), that licensees may convey the work under this License, and how to view a copy of this License. If the interface presents a list of user commands or options, such as a menu, a prominent item in the list meets this criterion.

### 1. Source Code.

The "source code" for a work means the preferred form of the work for making modifications to it. "Object code" means any non-source form of a work.

A "Standard Interface" means an interface that either is an official standard defined by a recognized standards body, or, in the case of interfaces specified for a particular programming language, one that is widely used among developers working in that language.

The "System Libraries" of an executable work include anything, other than the work as a whole, that (a) is included in the normal form of packaging a Major Component, but which is not part of that Major Component, and (b) serves only to enable use of the work with that Major Component, or to implement a Standard Interface for which an implementation is available to the public in source code form. A "Major Component", in this context, means a major essential component (kernel, window system, and so on) of the specific operating system (if any) on which the executable work runs, or a compiler used to produce the work, or an object code interpreter used to run it.

The "Corresponding Source" for a work in object code form means all the source code needed to generate, install, and (for an executable work) run the object code and to modify the work, including scripts to control those activities.

However, it does not include the work's System Libraries, or generalpurpose tools or generally available free programs which are used unmodified in performing those activities but which are not part of the work. For example, Corresponding Source includes interface definition files associated with source files for the work, and the source code for shared libraries and dynamically linked subprograms that the work is specifically designed to require, such as by intimate data communication or control flow between those subprograms and other parts of the work.

The Corresponding Source need not include anything that users can regenerate automatically from other parts of the Corresponding Source. The Corresponding Source for a work in source code form is that same work.

## 2. Basic Permissions.

All rights granted under this License are granted for the term of copyright on the Program, and are irrevocable provided the stated conditions are met. This License explicitly affirms your unlimited permission to run the unmodified Program. The output from running a covered work is covered by this License only if the output, given its content, constitutes a covered work. This License acknowledges your rights of fair use or other equivalent, as provided by copyright law.

You may make, run and propagate covered works that you do not convey, without conditions so long as your license otherwise remains in force. You may convey covered works to others for the sole purpose of having them make modifications exclusively for you, or provide you with facilities for running those works, provided that you comply with the terms of this License in conveying all material for which you do not control copyright. These thus making or running the covered works for you must do so exclusively on your behalf, under your direction and control, on terms that prohibit them from making any copies of your copyrighted material outside their relationship with you. Conveying under any other circumstances is permitted solely under the conditions stated below. Sublicensing is not allowed; section 10 makes it unnecessary.

## 3. Protecting Users' Legal Rights From anti-Circumvention Law.

No covered work shall be deemed part of an effective technological measure under any applicable law fulfilling obligations under article 11 of the WIPO copyright treaty adopted on 20 December 1996, or similar laws prohibiting or restricting circumvention of such measures.

When you convey a covered work, you waive any legal power to forbid circumvention of technological measures to the extent such circumvention is effected by exercising rights under this License with respect to the covered work, and you disclaim any intention to limit operation or modification of the work as a means of enforcing, against the work's users, your or third parties' legal rights to forbid circumvention of technological measures.

## 4. Conveying Verbatim Copies.

You may convey verbatim copies of the Program's source code as you receive it, in any medium, provided that you conspicuously and appropriately publish on each copy an appropriate copyright notice; keep intact all notices stating that this License and any non-permissive terms added in accord with section 7 apply to the code; keep intact all notices of the absence of any warranty; and give all recipients a copy of this License along with the Program. You may charge any price or no price for each copy that you convey, and you may offer support or warranty protection for a fee.

## 5. Conveying Modified Source Versions.

You may convey a work based on the Program, or the modifications to produce it from the Program, in the form of source code under the terms of section 4, provided that you also meet all of these conditions:

- The work must carry prominent notices stating that you modified it, and giving a relevant date.
- The work must carry prominent notices stating that it is released under this License and any conditions added under section 7. This requirement modifies the requirement in section 4 to "keep intact all notices".
- You must license the entire work, as a whole, under this License to anyone who comes into possession of a copy. This License will therefore apply, along with any applicable section 7 additional terms, to the whole of the work, and all its parts, regardless of how they are packaged. This License gives no permission to license the work in any other way, but it does not invalidate such permission if you have separately received it.
- If the work has interactive user interfaces, each must display Appropriate Legal Notices; however, if the Program has interactive interfaces that do not display Appropriate Legal Notices, your work need not make them do so. A compilation of a covered work with other separate and independent works, which are not by their nature extensions of the covered work, and which are not combined with it such as to form a larger program, in or on a volume of a storage or distribution medium, is called an "aggregate" if the compilation and its resulting copyright are not used to limit the access or legal rights of the compilation's users beyond what the individual works permit. Inclusion of a covered work in an aggregate does not cause this License to apply to the other parts of the aggregate.

## 6. Conveying Non-Source Forms.

You may convey a covered work in object code form under the terms of sections 4 and 5, provided that you also convey the machine-readable Corresponding Source under the terms of this License, in one of these ways:

- Convey the object code in, or embodied in, a physical product (including a physical distribution medium), accompanied by the Corresponding Source fixed on a durable physical medium customarily used for software interchange.
- Convey the object code in, or embodied in, a physical product (including a physical distribution medium), accompanied by a written offer, valid for at least three years and valid for as long as you offer spare parts or customer support for that product model, to give anyone who possesses the object code either (1) a copy of the Corresponding Source for all the software in the product that is covered by this License, on a durable physical medium customarily used for software interchange, for a price no more than your reasonable cost of physically performing this conveying of source, or (2) access to copy the Corresponding Source from a network server at no charge.
- Convey individual copies of the object code with a copy of the written offer to provide the corresponding Source. This alternative is allowed only occasionally and noncommercially, and only if you received the object code with such an offer, in accord with subsection 6b.
- Convey the object code by offering access from a designated place (gratis or for a charge), and offer equivalent access to the Corresponding Source in the same way through the same place at no further charge. You need not require recipients to copy the Corresponding Source along with the object code. If the place to copy the object code is a network server, the Corresponding Source may be on a different server (operated by you or a third party) that supports equivalent copying facilities, provided you maintain clear directions next to the object code saying where to find the Corresponding Source. Regardless of what server hosts the Corresponding Source, you remain obligated to ensure that it is available for as long as needed to satisfy these requirements.

- Convey the object code using peer-to-peer transmission, provided you inform other peers where the object code and Corresponding Source of the work are being offered to the general public at no charge under subsection 6d. A separable portion of the object code, whose source code is excluded from the Corresponding Source as a System Library, need not be included in conveying the object code work. A "User Product" is either (1) a "consumer product", which means any tangible personal property which is normally used for personal, family, or household purposes, or (2) anything designed or sold for incorporation into a dwelling. In determining whether a product is a consumer product, doubtful cases shall be resolved in favor of coverage. For a particular product received by a particular user, "normally used" refers to a typical or common use of that class of product, regardless of the status of the particular user or of the way in which the particular user actually uses, or expects or is expected to use, the product. A product is a consumer product regardless of whether the product has substantial commercial, industrial or non-consumer uses, unless such uses represent the only significant mode of use of the product.

"Installation Information" for a User Product means any methods, procedures, authorization keys, or other information required to install and execute modified versions of a covered work in that User Product from a modified version of its Corresponding Source. The information must suffice to ensure that the continued functioning of the modified object code is in no case prevented or interfered with solely because modification has been made. If you convey an object code work under this section in, or with, or specifically for use in, a User Product, and the conveying occurs as part of a transaction in which the right of possession and use of the User Product is transferred to the recipient in perpetuity or for a fixed term (regardless of how the transaction is characterized), the Corresponding Source conveyed under this section must be accompanied by the Installation Information. But this requirement does not apply if neither you nor any third party retains the ability to install modified object code on the User Product (for example, the work has been installed in ROM).

The requirement to provide Installation Information does not include a requirement to continue to provide support service, warranty, or updates for a work that has been modified or installed by the recipient, or for the User Product in which it has been modified or installed. Access to a network may be denied when the modification itself materially and adversely affects the operation of the network or violates the rules and protocols for communication across the network. Corresponding Source conveyed, and Installation Information provided, in accord with this section must be in a format that is publicly documented (and with an implementation available to the public in source code form), and must require no special password or key for unpacking, reading or copying.

## 7. Additional Terms.

"Additional permissions" are terms that supplement the terms of this License by making exceptions from one or more of its conditions. Additional permissions that are applicable to the entire Program shall be treated as though they were included in this License, to the extent that they are valid under applicable law. If additional permissions apply only to part of the Program, that part may be used separately under those permissions, but the entire Program remains governed by this License without regard to the additional permissions. When you convey a copy of a covered work, you may at your option remove any additional permissions from that copy, or from any part of it. (Additional permissions may be written to require their own removal in certain cases when you modify the work.) You may place additional permissions on material, added by you to a covered work, for which you have or can give appropriate copyright permission. Notwithstanding any other provision of this License, for material you add to a covered work, you may (if authorized by the copyright holders of that material) supplement the terms of this License with terms:

- Disclaiming warranty or limiting liability differently from the terms of sections 15 and 16 of this License; or
- Requiring preservation of specified reasonable legal notices or author attributions in that material or in the Appropriate Legal Notices displayed by works containing it; or
- Prohibiting misrepresentation of the origin of that material, or requiring that modified versions of such material be marked in reasonable ways as different from the original version; or
- Limiting the use for publicity purposes of names of licensors or authors of the material; or
- Declining to grant rights under trademark law for use of some trade names, trademarks, or service marks; or
- Requiring indemnification of licensors and authors of that material by anyone who conveys the material (or modified versions of it) with contractual assumptions of liability to the recipient, for any liability that these contractual assumptions directly impose on those licensors and authors. All other non-permissive additional terms are considered "further restrictions" within the meaning of section 10. If the Program as you received it, or any part of it, contains a notice stating that it is governed by this License along with a term that is a further restriction, you may remove that term. If a license document contains a further restriction but permits relicensing or conveying under this License, you may add to a covered work material governed by the terms of that license document, provided that the further restriction does not survive such relicensing or conveying. If you add terms to a covered work in accord with this section, you must place, in the relevant source files, a statement of the additional terms that apply to those files, or a notice indicating where to find the applicable terms. Additional terms, permissive or non-permissive, may be stated in the form of a separately written license, or stated as exceptions; the above requirements apply either way.

## 8. Termination.

You may not propagate or modify a covered work except as expressly provided under this License. Any attempt otherwise to propagate or modify it is void, and will automatically terminate your rights under this License (including any patent licenses granted under the third paragraph of section 11).

However, if you cease all violation of this License, then your license from a particular copyright holder is reinstated (a) provisionally, unless and until the copyright holder explicitly and finally terminates your license, and (b) permanently; if the copyright holder fails to notify you of the violation by some reasonable means prior to 60 days after the cessation. Moreover, your license from a particular copyright holder is reinstated permanently if the copyright holder notifies you of the violation by some reasonable means, this is the first time you have received notice of violation of this License for any work) from that copyright holder, and you cure the violation prior to 30 days after your receipt of the notice. Termination of your rights under this section does not terminate the licenses of parties who have received copies or rights from you under this License. If your rights have been terminated and not permanently reinstated, you do not qualify to receive new licenses for the same material under section 10.

## 9. Acceptance Not Required for Having Copies.

You are not required to accept this License in order to receive or run a copy of the Program. Ancillary propagation of a covered work occurring solely as a consequence of using peer-to-peer transmission to receive a copy likewise does not require acceptance. However, nothing other than this License grants you permission to propagate or modify any covered work. These actions infringe copyright if you do not accept this License. Therefore, by modifying or propagating a covered work, you indicate your acceptance of this License to do so.

## 10. Automatic Licensing of Downstream Recipients.

Each time you convey a covered work, the recipient automatically receives a license from the original licensors, to run, modify and propagate that work, subject to this License. You are not responsible for enforcing compliance by third parties with this License. An "entity transaction" is a transaction transferring control of an organization, or substantially all assets of one, or subdividing an organization, or merging organizations. If propagation of a covered work results from an entity transaction, each party to that transaction who receives a copy of the work also receives whatever licenses to the work the party's predecessor in interest had or could give under the previous paragraph, plus a right to possession of the Corresponding Source of the work from the predecessor in interest, if the predecessor has it or can get it with reasonable efforts. You may not impose any further restrictions on the exercise of the rights granted or affirmed under this License. For example, you may not impose a license fee, royalty, or other charge for exercise of rights granted under this License, and you may not initiate litigation (including a cross-claim or counterclaim in a lawsuit) alleging that any patent claim is infringed by making, using, selling, offering for sale, or importing the Program or any portion of it.

## 11. Patents.

A "contributor" is a copyright holder who authorizes use under this License of the Program or a work on which the Program is based. The work thus licensed is called the contributor's "contributor version". A contributor's "essential patent claims" are all patent claims owned or controlled by the contributor, whether already acquired or hereafter acquired, that would be infringed by some manner, permitted by this License, of making, using, or selling its contributor version, but do not include claims that would be infringed only as a consequence of further modification of the contributor version. For purposes of this definition, "control" includes the right to grant patent sublicenses in a manner consistent with the requirements of this License. Each contributor grants you a non-exclusive, worldwide, royalty-free patent license under the contributor's essential patent claims, to make, use, sell, offer for sale, import and otherwise run, modify and propagate the contents of its contributor version.

In the following three paragraphs, a "patent license" is any express agreement or commitment, however denominated, not to enforce a patent (such as an express permission to practice a patent or covenant not to sue for patent infringement). To "grant" such a patent license to a party means to make such an agreement or commitment not to enforce a patent against the party. If you convey a covered work, knowingly relying on a patent license, and the Corresponding Source of the work is not available for anyone to copy, free of charge and under the terms of this License, through a publicly available network server or other readily accessible means, then you must either (1) cause the Corresponding Source to be so available, or (2) arrange to deprive yourself of the benefit of the patent license for this particular work, or (3) arrange, in a manner consistent with the requirements of this License, to extend the patent license to downstream recipients. "Knowingly relying" means you have actual knowledge that, but for the patent license, your conveying the covered work in a country, or your recipient's use of the covered work in a country, would infringe one or more identifiable patents in that country that you have reason to believe are valid. If, pursuant to or in connection with a single transaction or arrangement, you convey, or propagate by procuring conveyance of, a covered work, and grant a

patent license to some of the parties receiving the covered work authorizing them to use, propagate, modify or convey a specific copy of the covered work, then the patent license you grant is automatically extended to all recipients of the covered work and works based on it. A patent license is "discriminatory" if it does not include within the scope of its coverage, prohibits the exercise of, or is conditioned on the non-exercise of one or more of the rights that are specifically granted under this License. You may not convey a covered work if you are a party to an arrangement with a third party that is in the business of distributing software, under which you make payment to the third party based on the extent of your activity of conveying the work, and under which the third party grants, to any of the parties who would receive the covered work from you, a discriminatory patent license

(a) in connection with copies of the covered work conveyed by you (or copies made from those copies), or

(b) primarily for and in connection with specific products or compilations that contain the covered work, unless you entered into that arrangement, or that patent license was granted, prior to 29 March 2007. Nothing in this License shall be construed as excluding or limiting any implied license or other defenses to infringement that may otherwise be available to you under applicable patent law.

#### 12. No Surrender of Others' Freedom.

If conditions are imposed on you (whether by court order, agreement or otherwise) that contradict the conditions of this License, they do not excuse you from the conditions of this License. If you cannot convey a covered work so as to satisfy simultaneously your obligations under this License and any other pertinent obligations, then as a consequence you may not convey it at all. For example, if you agree to terms that obligate you to collect a royalty for further conveying from those to whom you convey the Program, the only way you could satisfy both those terms and this License would be to refrain entirely from conveying the Program.

#### 13. Use with the GNU Affero General Public License.

Notwithstanding any other provision of this License, you have permission to link or combine any covered work with a work licensed under version 3 of the GNU Affero General Public License into a single combined work, and to convey the resulting work. The terms of this License will continue to apply to the part which is the covered work, but the special requirements of the GNU Affero General Public License, section 13, concerning interaction through a network will apply to the combination as such.

#### 14. Revised Versions of this License.

The Free Software Foundation may publish revised and/or new versions of the GNU General Public License from time to time. Such new versions will be similar in spirit to the present version, but may differ in detail to address new problems or concerns.

Each version is given a distinguishing version number. If the Program specifies that a certain numbered version of the GNU General Public License "or any later version" applies to it, you have the option of following the terms and conditions either of that numbered version or of any later version published by the Free Software Foundation. If the Program does not specify a version number of the GNU General Public License, you may choose any version ever published by the Free Software Foundation. If the Program specifies that a proxy can decide which future versions of the GNU General Public License can be used, that proxy's public statement of acceptance of a version permanently authorizes you to choose that version for the Program. Later license versions may give you additional or different permissions. However, no additional obligations are imposed on any author or copyright holder as a result of your choosing to follow a later version.

#### 15. Disclaimer of Warranty.

THERE IS NO WARRANTY FOR THE PROGRAM, TO THE EXTENT PERMITTED BY APPLICABLE LAW. EXCEPT WHEN OTHERWISE STATED IN WRITING THE COPYRIGHT HOLDERS AND/OR OTHER PARTIES PROVIDE THE PROGRAM "AS IS" WITHOUT WARRANTY OF ANY KIND, EITHER EXPRESSED OR IMPLIED, INCLUDING, BUT NOT LIMITED TO, THE IMPLIED WARRANTIES OF MERCHANTABILITY AND FITNESS FOR A PARTICULAR PURPOSE. THE ENTIRE RISK AS TO THE QUALITY AND PERFORMANCE OF THE PROGRAM IS WITH YOU. SHOULD THE PROGRAM PROVE DEFECTIVE, YOU ASSUME THE COST OF ALL NECESSARY SERVICING, REPAIR OR CORRECTION.

#### 16. Limitation of Liability.

IN NO EVENT UNLESS REQUIRED BY APPLICABLE LAW OR AGREED TO IN WRITING WILL ANY COPYRIGHT HOLDER, OR ANY OTHER PARTY WHO MODIFIES AND/OR CONVEYS THE PROGRAM AS PERMITTED ABOVE, BE LIABLE TO YOU FOR DAMAGES, INCLUDING ANY GENERAL, SPECIAL, INCIDENTAL OR CONSEQUENTIAL DAMAGES ARISING OUT OF THE USE OR INABILITY TO USE THE PROGRAM (INCLUDING BUT NOT LIMITED TO LOSS OF DATA OR DATA BEING RENDERED INACCURATE OR LOSSES SUSTAINED BY YOU OR THIRD PARTIES OR A FAILURE OF THE PROGRAM TO OPERATE WITH ANY OTHER PROGRAMS), EVEN IF SUCH HOLDER OR OTHER PARTY HAS BEEN ADVISED OF THE POSSIBILITY OF SUCH DAMAGES.

#### 17. Interpretation of Sections 15 and 16.

If the disclaimer of warranty and limitation of liability provided above cannot be given local legal effect according to their terms, reviewing courts shall apply local law that most closely approximates an absolute waiver of all civil liability in connection with the Program, unless a warranty or assumption of liability accompanies a copy of the Program in return for a fee.

## OpenSSL Combined License

The OpenSSL toolkit stays under a dual license, i.e. both the conditions of the OpenSSL License and the original SSLeay license apply to the toolkit.

See below for the actual license texts. Actually both licenses are BSD-style Open Source licenses. In case of any license issues related to OpenSSL please contact openssl-core@openssl.org.

Component Name	License	URL
openssl-1.0.1g	OpenSSL	Combined License <a href="http://www.openssl.org/source">http://www.openssl.org/source</a>

Copyright (c) 1998-2011 The OpenSSL Project. All rights reserved.

Redistribution and use in source and binary forms, with or without modification, are permitted provided that the following conditions are met:

1. Redistributions of source code must retain the above copyright notice, this list of conditions and the following disclaimer.
2. Redistributions in binary form must reproduce the above copyright notice, this list of conditions and the following disclaimer in the documentation and/or other materials provided with the distribution.
3. All advertising materials mentioning features or use of this software must display the following acknowledgment: "This product includes software developed by the OpenSSL Project for use in the OpenSSL Toolkit. (<http://www.openssl.org/>)"
4. The names "OpenSSL Toolkit" and "OpenSSL Project" must not be used to endorse or promote products derived from this software without prior written permission. For written permission, please contact openssl-core@openssl.org.
5. Products derived from this software may not be called "OpenSSL" nor may "OpenSSL" appear in their names without prior written permission of the OpenSSL Project.

6. Redistributions of any form whatsoever must retain the following acknowledgment: "This product includes software developed by the OpenSSL Project for use in the OpenSSL Toolkit (<http://www.openssl.org/>)"

THIS SOFTWARE IS PROVIDED BY THE OpenSSL PROJECT "AS IS" AND ANY EXPRESSED OR IMPLIED WARRANTIES, INCLUDING, BUT NOT LIMITED TO, THE IMPLIED WARRANTIES OF MERCHANTABILITY AND FITNESS FOR A PARTICULAR PURPOSE ARE DISCLAIMED. IN NO EVENT SHALL THE OpenSSL PROJECT OR ITS CONTRIBUTORS BE LIABLE FOR ANY DIRECT, INDIRECT, INCIDENTAL, SPECIAL, EXEMPLARY, OR CONSEQUENTIAL DAMAGES (INCLUDING, BUT NOT LIMITED TO, PROCUREMENT OF SUBSTITUTE GOODS OR SERVICES; LOSS OF USE, DATA, OR PROFITS; OR BUSINESS INTERRUPTION) HOWEVER CAUSED AND ON ANY THEORY OF LIABILITY, WHETHER IN CONTRACT, STRICT LIABILITY, OR TORT (INCLUDING NEGLIGENCE OR OTHERWISE) ARISING IN ANY WAY OUT OF THE USE OF THIS SOFTWARE, EVEN IF ADVISED OF THE POSSIBILITY OF SUCH DAMAGE.

This product includes cryptographic software written by Eric Young ([ey@cryptsoft.com](mailto:ey@cryptsoft.com)). This product includes software written by Tim Hudson ([tjh@cryptsoft.com](mailto:tjh@cryptsoft.com)).

#### Original SSLeay License

Copyright (C) 1995-1998 Eric Young ([ey@cryptsoft.com](mailto:ey@cryptsoft.com)) All rights reserved.

This package is an SSL implementation written by Eric Young ([ey@cryptsoft.com](mailto:ey@cryptsoft.com)).

The implementation was written so as to conform with Netscapes SSL.

This library is free for commercial and non-commercial use as long as the following conditions are adhered to. The following conditions apply to all code found in this distribution, be it the RC4, RSA, lhash, DES, etc., code; not just the SSL code. The SSL documentation included with this distribution is covered by the same copyright terms except that the holder is Tim Hudson ([tjh@cryptsoft.com](mailto:tjh@cryptsoft.com)).

Copyright remains Eric Young's, and as such any Copyright notices in the code are not to be removed. If this package is used in a product, Eric Young should be given attribution as the author of the parts of the library used. This can be in the form of a textual message at program startup or in documentation (online or textual) provided with the package. Redistribution and use in source and binary forms, with or without modification, are permitted provided that the following conditions are met:

1. Redistributions of source code must retain the copyright notice, this list of conditions and the following disclaimer.
2. Redistributions in binary form must reproduce the above copyright notice, this list of conditions and the following disclaimer in the documentation and/or other materials provided with the distribution.
3. All advertising materials mentioning features or use of this software must display the following acknowledgment: "This product includes cryptographic software written by Eric Young ([ey@cryptsoft.com](mailto:ey@cryptsoft.com))" The word "cryptographic" can be left out if the routines from the library being used are not cryptographic related :-).
4. If you include any Windows specific code (or a derivative thereof) from the apps directory (application code) you must include an acknowledgment: "This product includes software written by Tim Hudson ([tjh@cryptsoft.com](mailto:tjh@cryptsoft.com))"

THIS SOFTWARE IS PROVIDED BY ERIC YOUNG "AS IS" AND ANY EXPRESS OR IMPLIED WARRANTIES, INCLUDING, BUT NOT LIMITED TO, THE IMPLIED WARRANTIES OF MERCHANTABILITY AND FITNESS FOR A PARTICULAR PURPOSE ARE DISCLAIMED. IN NO EVENT SHALL THE AUTHOR OR CONTRIBUTORS BE LIABLE FOR ANY DIRECT, INDIRECT, INCIDENTAL, SPECIAL, EXEMPLARY, OR CONSEQUENTIAL DAMAGES (INCLUDING, BUT NOT LIMITED TO, PROCUREMENT OF SUBSTITUTE GOODS OR SERVICES; LOSS OF USE, DATA, OR PROFITS; OR BUSINESS INTERRUPTION) HOWEVER CAUSED AND ON ANY THEORY OF LIABILITY, WHETHER IN CONTRACT, STRICT LIABILITY, OR TORT (INCLUDING NEGLIGENCE OR OTHERWISE) ARISING IN ANY WAY OUT OF THE USE OF THIS SOFTWARE, EVEN IF ADVISED OF THE POSSIBILITY OF SUCH DAMAGE.

The license and distribution terms for any publicly available version or derivative of this code cannot be changed. i.e. this code cannot simply be copied and put under another distribution licence [including the GNU Public Licence.]

## BSD License

Some software components of this product incorporate source code covered under the BSD license as follows.

Component Name	License	URL
net-snmp-5.7.1	BSD	<a href="http://www.net-snmp.org/about/license.html">http://www.net-snmp.org/about/license.html</a>
pcre-8.20	BSD	
openssl-5.9p1	BSD	
libcap-1.2.1	BSD 2.0	<a href="http://www.kernel.org/pub/linux/libs/security/linux-privs/libcap2">http://www.kernel.org/pub/linux/libs/security/linux-privs/libcap2</a>
lighttpd-1.4.35	BSD 2.0	<a href="http://www.opensource.org/licenses/bsd-license.html">http://www.opensource.org/licenses/bsd-license.html</a>
Garne-ws	BSD 2.0	
MiniUPnP Project Client	BSD 2.0	
pppd-2.4.5	BSD 2.0	<a href="http://opensource.org/licenses/BSD-3-Clause">http://opensource.org/licenses/BSD-3-Clause</a>

lighttpd is a secure, fast, compliant, and very flexible webserver that has been optimized for high-performance environments. It has a very low memory footprint compared to other web servers and takes care of opload. Its advanced feature-set (FastCGI, CGI, Auth, Output-Compression, URL-Rewriting and many more) make lighttpd the perfect webserver-software for every server that suffers load problems. Simple Network Management Protocol (SNMP) is an Internet-standard protocol for managing devices on IP networks. It is used mostly in network management systems to monitor the devices attached to the network for conditions that need administrative attention. Net-SNMP is a suite of applications used to implement SNMP v1, SNMP v2c and SNMP v3 using both IP4v and IP6v. For more additional information, send email to [help.cctv@nanhwa.com](mailto:help.cctv@nanhwa.com).

Copyright (C) 2004, Kneschke, incremental

All rights reserved.

Redistribution and use in source and binary forms, with or without modification, are permitted provided that the following conditions are met :

- Redistributions of source code must retain the above copyright notice, this list of conditions and the following disclaimer.
- Redistributions in binary form must reproduce the above copyright notice, this list of conditions and the following disclaimer in the documentation and/or other materials provided with the distribution.
- Neither the name of the "incremental" nor the names of its contributors may be used to endorse or promote products derived from this software without specific prior written permission.

THIS SOFTWARE IS PROVIDED BY THE COPYRIGHT HOLDERS AND CONTRIBUTORS "AS IS" AND ANY EXPRESS OR IMPLIED WARRANTIES, INCLUDING, BUT NOT LIMITED TO, THE IMPLIED WARRANTIES OF MERCHANTABILITY AND FITNESS FOR A PARTICULAR PURPOSE ARE DISCLAIMED. IN NO EVENT SHALL THE COPYRIGHT OWNER OR CONTRIBUTORS BE LIABLE FOR ANY DIRECT, INDIRECT, INCIDENTAL, SPECIAL, EXEMPLARY, OR CONSEQUENTIAL DAMAGES (INCLUDING, BUT NOT LIMITED TO, PROCUREMENT OF SUBSTITUTE GOODS OR SERVICES; LOSS OF USE, DATA, OR PROFITS; OR BUSINESS INTERRUPTION) HOWEVER CAUSED AND ON ANY THEORY OF LIABILITY, WHETHER IN CONTRACT, STRICT LIABILITY, OR TORT (INCLUDING NEGLIGENCE OR OTHERWISE) ARISING IN ANY WAY OUT OF THE USE OF THIS SOFTWARE, EVEN IF ADVISED OF THE POSSIBILITY OF SUCH DAMAGE.

Copyright (c) 1998-2001 University College London

All rights reserved.

Redistribution and use in source and binary forms, with or without modification, is permitted provided that the following conditions are met :

1. Redistributions of source code must retain the above copyright notice, this list of conditions and the following disclaimer.
2. Redistributions in binary form must reproduce the above copyright notice, this list of conditions and the following disclaimer in the documentation and/or other materials provided with the distribution.
3. All advertising materials mentioning features or use of this software must display the following acknowledgement: This product includes software developed by the Computer Science Department at University College London.
4. Neither the name of the University nor of the Department may be used to endorse or promote products derived from this software without specific prior written permission.

THIS SOFTWARE IS PROVIDED BY THE AUTHORS AND CONTRIBUTORS "AS IS" AND ANY EXPRESSED OR IMPLIED WARRANTIES, INCLUDING, BUT NOT LIMITED TO, THE IMPLIED WARRANTIES OF MERCHANTABILITY AND FITNESS FOR A PARTICULAR PURPOSE ARE DISCLAIMED. IN NO EVENT SHALL THE AUTHORS OR CONTRIBUTORS BE LIABLE FOR ANY DIRECT, INDIRECT, INCIDENTAL, SPECIAL, EXEMPLARY, OR CONSEQUENTIAL DAMAGES (INCLUDING, BUT NOT LIMITED TO, PROCUREMENT OF SUBSTITUTE GOODS OR SERVICES; LOSS OF USE, DATA, OR PROFITS; OR BUSINESS INTERRUPTION) HOWEVER CAUSED AND ON ANY THEORY OF LIABILITY, WHETHER IN CONTRACT, STRICT LIABILITY, OR TORT (INCLUDING NEGLIGENCE OR OTHERWISE) ARISING IN ANY WAY OUT OF THE USE OF THIS SOFTWARE, EVEN IF ADVISED OF THE POSSIBILITY OF SUCH DAMAGE.

Copyright (c) 1988, 1989, 1990, 1991, 1993, 1994, 1995, 1996 The Regents of the University of California.

All rights reserved.

Redistribution and use in source and binary forms, with or without modification, are permitted provided that the following conditions are met:

1. Redistributions of source code must retain the above copyright notice, this list of conditions and the following disclaimer.
2. Redistributions in binary form must reproduce the above copyright notice, this list of conditions and the following disclaimer in the documentation and/or other materials provided with the distribution.
3. Neither the name of the Regents of the University of California nor the names of its contributors may be used to endorse or promote products derived from this software without specific prior written permission.

THIS SOFTWARE IS PROVIDED BY THE COPYRIGHT HOLDERS AND CONTRIBUTORS "AS IS" AND ANY EXPRESS OR IMPLIED WARRANTIES, INCLUDING, BUT NOT LIMITED TO, THE IMPLIED WARRANTIES OF MERCHANTABILITY AND FITNESS FOR A PARTICULAR PURPOSE ARE DISCLAIMED. IN NO EVENT SHALL THE COPYRIGHT OWNER OR CONTRIBUTORS BE LIABLE FOR ANY DIRECT, INDIRECT, INCIDENTAL, SPECIAL, EXEMPLARY, OR CONSEQUENTIAL DAMAGES (INCLUDING, BUT NOT LIMITED TO, PROCUREMENT OF SUBSTITUTE GOODS OR SERVICES; LOSS OF USE, DATA, OR PROFITS; OR BUSINESS INTERRUPTION) HOWEVER CAUSED AND ON ANY THEORY OF LIABILITY, WHETHER IN CONTRACT, STRICT LIABILITY, OR TORT (INCLUDING NEGLIGENCE OR OTHERWISE) ARISING IN ANY WAY OUT OF THE USE OF THIS SOFTWARE, EVEN IF ADVISED OF THE POSSIBILITY OF SUCH DAMAGE.

Copyright (c) 2006, Creative Labs Inc

All rights reserved.

Redistribution and use in source and binary forms, with or without modification, are permitted provided that the following conditions are met:

1. Redistributions of source code must retain the above copyright notice, this list of conditions and the following disclaimer.
2. Redistributions in binary form must reproduce the above copyright notice, this list of conditions and the following disclaimer in the documentation and/or other materials provided with the distribution.
3. Neither the name of the Creative Labs nor the names of its contributors may be used to endorse or promote products derived from this software without specific prior written permission.

THIS SOFTWARE IS PROVIDED BY THE COPYRIGHT HOLDERS AND CONTRIBUTORS "AS IS" AND ANY EXPRESS OR IMPLIED WARRANTIES, INCLUDING, BUT NOT LIMITED TO, THE IMPLIED WARRANTIES OF MERCHANTABILITY AND FITNESS FOR A PARTICULAR PURPOSE ARE DISCLAIMED. IN NO EVENT SHALL THE COPYRIGHT OWNER OR CONTRIBUTORS BE LIABLE FOR ANY DIRECT, INDIRECT, INCIDENTAL, SPECIAL, EXEMPLARY, OR CONSEQUENTIAL DAMAGES (INCLUDING, BUT NOT LIMITED TO, PROCUREMENT OF SUBSTITUTE GOODS OR SERVICES; LOSS OF USE, DATA, OR PROFITS; OR BUSINESS INTERRUPTION) HOWEVER CAUSED AND ON ANY THEORY OF LIABILITY, WHETHER IN CONTRACT, STRICT LIABILITY, OR TORT (INCLUDING NEGLIGENCE OR OTHERWISE) ARISING IN ANY WAY OUT OF THE USE OF THIS SOFTWARE, EVEN IF ADVISED OF THE POSSIBILITY OF SUCH DAMAGE.

Copyright (c) 2005-2012, Thomas BERNARD

All rights reserved.

Redistribution and use in source and binary forms, with or without modification, are permitted provided that the following conditions are met:

1. Redistributions of source code must retain the above copyright notice, this list of conditions and the following disclaimer.
2. Redistributions in binary form must reproduce the above copyright notice, this list of conditions and the following disclaimer in the documentation and/or other materials provided with the distribution.
3. Neither the name of Thomas BERNARD nor the names of its contributors may be used to endorse or promote products derived from this software without specific prior written permission.

THIS SOFTWARE IS PROVIDED BY THE COPYRIGHT HOLDERS AND CONTRIBUTORS "AS IS" AND ANY EXPRESS OR IMPLIED WARRANTIES, INCLUDING, BUT NOT LIMITED TO, THE IMPLIED WARRANTIES OF MERCHANTABILITY AND FITNESS FOR A PARTICULAR PURPOSE ARE DISCLAIMED. IN NO EVENT SHALL THE COPYRIGHT OWNER OR CONTRIBUTORS BE LIABLE FOR ANY DIRECT, INDIRECT, INCIDENTAL, SPECIAL, EXEMPLARY, OR CONSEQUENTIAL DAMAGES (INCLUDING, BUT NOT LIMITED TO, PROCUREMENT OF SUBSTITUTE GOODS OR SERVICES; LOSS OF USE, DATA, OR PROFITS; OR BUSINESS INTERRUPTION) HOWEVER CAUSED AND ON ANY THEORY OF LIABILITY, WHETHER IN CONTRACT, STRICT LIABILITY, OR

TORT (INCLUDING NEGLIGENCE OR OTHERWISE) ARISING IN ANY WAY OUT OF THE USE OF THIS SOFTWARE, EVEN IF ADVISED OF THE POSSIBILITY OF SUCH DAMAGE.

Various copyrights apply to this package, listed in various separate parts below. Please make sure that you read all the parts.

#### **Part 1 : CMU/UCD copyright notice: (BSD like)**

Copyright 1989, 1991, 1992 by Carnegie Mellon University Derivative Work - 1996, 1998-2000

Copyright 1996, 1998-2000 The Regents of the University of California

All Rights Reserved

Permission to use, copy, modify and distribute this software and its documentation for any purpose and without fee is hereby granted, provided that the above copyright notice appears in all copies and that both that copyright notice and this permission notice appear in supporting documentation, and that the name of CMU and The Regents of the University of California not be used in advertising or publicity pertaining to distribution of the software without specific written permission.

CMU AND THE REGENTS OF THE UNIVERSITY OF CALIFORNIA DISCLAIM ALL WARRANTIES WITH REGARD TO THIS SOFTWARE, INCLUDING ALL IMPLIED WARRANTIES OF MERCHANTABILITY AND FITNESS. IN NO EVENT SHALL CMU OR THE REGENTS OF THE UNIVERSITY OF CALIFORNIA BE LIABLE FOR ANY SPECIAL, INDIRECT OR CONSEQUENTIAL DAMAGES OR ANY DAMAGES WHATSOEVER RESULTING FROM THE LOSS OF USE, DATA OR PROFITS, WHETHER IN AN ACTION OF CONTRACT, NEGLIGENCE OR OTHER TORTIOUS ACTION, ARISING OUT OF OR IN CONNECTION WITH THE USE OR PERFORMANCE OF THIS SOFTWARE.

#### **Part 2 : Networks Associates Technology, Inc copyright notice (BSD)**

Copyright (c) 2001-2003, Networks Associates Technology, Inc

All rights reserved.

Redistribution and use in source and binary forms, with or without modification, are permitted provided that the following conditions are met: yy Redistributions of source code must retain the above copyright notice, this list of conditions and the following disclaimer. yy Redistributions in binary form must reproduce the above copyright notice, this list of conditions and the following disclaimer in the documentation and/or other materials provided with the distribution. yy Neither the name of the Networks Associates Technology, Inc nor the names of its contributors may be used to endorse or promote products derived from this software without specific prior written permission.

THIS SOFTWARE IS PROVIDED BY THE COPYRIGHT HOLDERS AND CONTRIBUTORS "AS IS" AND ANY EXPRESS OR IMPLIED WARRANTIES, INCLUDING, BUT NOT LIMITED TO, THE IMPLIED WARRANTIES OF MERCHANTABILITY AND FITNESS FOR A PARTICULAR PURPOSE ARE DISCLAIMED. IN NO EVENT SHALL THE COPYRIGHT HOLDERS OR CONTRIBUTORS BE LIABLE FOR ANY DIRECT, INDIRECT, INCIDENTAL, SPECIAL, EXEMPLARY, OR CONSEQUENTIAL DAMAGES (INCLUDING, BUT NOT LIMITED TO, PROCUREMENT OF SUBSTITUTE GOODS OR SERVICES; LOSS OF USE, DATA, OR PROFITS; OR BUSINESS INTERRUPTION) HOWEVER CAUSED AND ON ANY THEORY OF LIABILITY, WHETHER IN CONTRACT, STRICT LIABILITY, OR TORT (INCLUDING NEGLIGENCE OR OTHERWISE) ARISING IN ANY WAY OUT OF THE USE OF THIS SOFTWARE, EVEN IF ADVISED OF THE POSSIBILITY OF SUCH DAMAGE.

#### **Part 3 : Cambridge Broadband Ltd. copyrightnotice (BSD)**

Portions of this code are copyright (c) 2001-2003, Cambridge Broadband Ltd.

All rights reserved.

Redistribution and use in source and binary forms, with or without modification, are permitted provided that the following conditions are met: yy Redistributions of source code must retain the above copyright notice, this list of conditions and the following disclaimer. yy Redistributions in binary form must reproduce the above copyright notice, this list of conditions and the following disclaimer in the documentation and/or other materials provided with the distribution. yy The name of Cambridge Broadband Ltd. may not be used to endorse or promote products derived from this software without specific prior written permission.

THIS SOFTWARE IS PROVIDED BY THE COPYRIGHT HOLDER "AS IS" AND ANY EXPRESS OR IMPLIED WARRANTIES, INCLUDING, BUT NOT LIMITED TO, THE IMPLIED WARRANTIES OF MERCHANTABILITY AND FITNESS FOR A PARTICULAR PURPOSE ARE DISCLAIMED. IN NO EVENT SHALL THE COPYRIGHT HOLDER BE LIABLE FOR ANY DIRECT, INDIRECT, INCIDENTAL, SPECIAL, EXEMPLARY, OR CONSEQUENTIAL DAMAGES (INCLUDING, BUT NOT LIMITED TO, PROCUREMENT OF SUBSTITUTE GOODS OR SERVICES; LOSS OF USE, DATA, OR PROFITS; OR BUSINESS INTERRUPTION) HOWEVER CAUSED AND ON ANY THEORY OF LIABILITY, WHETHER IN CONTRACT, STRICT LIABILITY, OR TORT (INCLUDING NEGLIGENCE OR OTHERWISE) ARISING IN ANY WAY OUT OF THE USE OF THIS SOFTWARE, EVEN IF ADVISED OF THE POSSIBILITY OF SUCH DAMAGE.

#### **Part 4 : Sun Microsystems, Inc. copyright notice**

(BSD)

Copyright (c) 2003 Sun Microsystems, Inc., 4150 Network

Circle, Santa Clara, California 95054, U.S.A.

All rights reserved.

Use is subject to license terms below. This distribution may include materials developed by third parties. Sun, Sun Microsystems, the Sun logo and Solaris are trademarks or registered trademarks of Sun Microsystems, Inc. in the U.S. and other countries. Redistribution and use in source and binary forms, with or without modification, are permitted provided that the following conditions are met: yy Redistributions of source code must retain the above copyright notice, this list of conditions and the following disclaimer. yy Redistributions in binary form must reproduce the above copyright notice, this list of conditions and the following disclaimer in the documentation and/or other materials provided with the distribution. yy Neither the name of the Sun Microsystems, Inc. nor the names of its contributors may be used to endorse or promote products derived from this software without specific prior written permission.

THIS SOFTWARE IS PROVIDED BY THE COPYRIGHT HOLDERS AND CONTRIBUTORS "AS IS" AND ANY EXPRESS OR IMPLIED WARRANTIES, INCLUDING, BUT NOT LIMITED TO, THE IMPLIED WARRANTIES OF MERCHANTABILITY AND FITNESS FOR A PARTICULAR PURPOSE ARE DISCLAIMED. IN NO EVENT SHALL THE COPYRIGHT HOLDERS OR CONTRIBUTORS BE LIABLE FOR ANY DIRECT, INDIRECT, INCIDENTAL, SPECIAL, EXEMPLARY, OR CONSEQUENTIAL DAMAGES (INCLUDING, BUT NOT LIMITED TO, PROCUREMENT OF SUBSTITUTE GOODS OR SERVICES; LOSS OF USE, DATA, OR PROFITS; OR BUSINESS INTERRUPTION) HOWEVER CAUSED AND ON ANY THEORY OF LIABILITY, WHETHER IN CONTRACT, STRICT LIABILITY, OR TORT (INCLUDING NEGLIGENCE OR OTHERWISE) ARISING IN ANY WAY OUT OF THE USE OF THIS SOFTWARE, EVEN IF ADVISED OF THE POSSIBILITY OF SUCH DAMAGE.

#### **Part 5 : Sparta, Inc copyright notice (BSD)**

Copyright (c) 2003-2009, Sparta, Inc

All rights reserved.

Redistribution and use in source and binary forms, with or without modification, are permitted provided that the following conditions are met: yy Redistributions of source code must retain the above copyright notice, this list of conditions and the following disclaimer. yy Redistributions in binary form must reproduce the



above copyright notice, this list of conditions and the following disclaimer in the documentation and/or other materials provided with the distribution. yy Neither the name of Sparta, Inc nor the names of its contributors may be used to endorse or promote products derived from this software without specific prior written permission.

THIS SOFTWARE IS PROVIDED BY THE COPYRIGHT HOLDERS AND CONTRIBUTORS "AS IS" AND ANY EXPRESS OR IMPLIED WARRANTIES, INCLUDING, BUT NOT LIMITED TO, THE IMPLIED WARRANTIES OF MERCHANTABILITY AND FITNESS FOR A PARTICULAR PURPOSE ARE DISCLAIMED. IN NO EVENT SHALL THE COPYRIGHT HOLDERS OR CONTRIBUTORS BE LIABLE FOR ANY DIRECT, INDIRECT, INCIDENTAL, SPECIAL, EXEMPLARY, OR CONSEQUENTIAL DAMAGES (INCLUDING, BUT NOT LIMITED TO, PROCUREMENT OF SUBSTITUTE GOODS OR SERVICES; LOSS OF USE, DATA, OR PROFITS; OR BUSINESS INTERRUPTION) HOWEVER CAUSED AND ON ANY THEORY OF LIABILITY, WHETHER IN CONTRACT, STRICT LIABILITY, OR TORT (INCLUDING NEGLIGENCE OR OTHERWISE) ARISING IN ANY WAY OUT OF THE USE OF THIS SOFTWARE, EVEN IF ADVISED OF THE POSSIBILITY OF SUCH DAMAGE.

#### Part 6: Cisco/BUPTNIC copyright notice (BSD)

Copyright (c) 2004, Cisco, Inc and Information Network

Center of Beijing University of Posts and Telecommunications.

All rights reserved.

Redistribution and use in source and binary forms, with or without modification, are permitted provided that the following conditions are met: yy Redistributions of source code must retain the above copyright notice, this list of conditions and the following disclaimer. yy Redistributions in binary form must reproduce the above copyright notice, this list of conditions and the following disclaimer in the documentation and/or other materials provided with the distribution. yy Neither the name of Cisco, Inc, Beijing University of Posts and Telecommunications, nor the names of their contributors may be used to endorse or promote products derived from this software without specific prior written permission.

THIS SOFTWARE IS PROVIDED BY THE COPYRIGHT HOLDERS AND CONTRIBUTORS "AS IS" AND ANY EXPRESS OR IMPLIED WARRANTIES, INCLUDING, BUT NOT LIMITED TO, THE IMPLIED WARRANTIES OF MERCHANTABILITY AND FITNESS FOR A PARTICULAR PURPOSE ARE DISCLAIMED. IN NO EVENT SHALL THE COPYRIGHT HOLDERS OR CONTRIBUTORS BE LIABLE FOR ANY DIRECT, INDIRECT, INCIDENTAL, SPECIAL, EXEMPLARY, OR CONSEQUENTIAL DAMAGES (INCLUDING, BUT NOT LIMITED TO, PROCUREMENT OF SUBSTITUTE GOODS OR SERVICES; LOSS OF USE, DATA, OR PROFITS; OR BUSINESS INTERRUPTION) HOWEVER CAUSED AND ON ANY THEORY OF LIABILITY, WHETHER IN CONTRACT, STRICT LIABILITY, OR TORT (INCLUDING NEGLIGENCE OR OTHERWISE) ARISING IN ANY WAY OUT OF THE USE OF THIS SOFTWARE, EVEN IF ADVISED OF THE POSSIBILITY OF SUCH DAMAGE.

#### Part 7: Fabasoft R&D Software Software GmbH & Co KG copyright Notice (BSD)

Copyright (c) Fabasoft R&D Software GmbH & Co KG, 2003oss@fabasoft.com

Author: Bernhard Penz

Redistribution and use in source and binary forms, with or without modification, are permitted provided that the following conditions are met: yy Redistributions of source code must retain the above copyright notice, this list of conditions and the following disclaimer. yy Redistributions in binary form must reproduce the above copyright notice, this list of conditions and the following disclaimer in the documentation and/or other materials provided with the distribution. yy The name of Fabasoft R&D Software GmbH & Co KG or any of its subsidiaries, brand or product names may not be used to endorse or promote products derived from this software without specific prior written permission.

THIS SOFTWARE IS PROVIDED BY THE COPYRIGHT HOLDER "AS IS" AND ANY EXPRESS OR IMPLIED WARRANTIES, INCLUDING, BUT NOT LIMITED TO, THE IMPLIED WARRANTIES OF MERCHANTABILITY AND FITNESS FOR A PARTICULAR PURPOSE ARE DISCLAIMED. IN NO EVENT SHALL THE COPYRIGHT HOLDER BE LIABLE FOR ANY DIRECT, INDIRECT, INCIDENTAL, SPECIAL, EXEMPLARY, OR CONSEQUENTIAL DAMAGES (INCLUDING, BUT NOT LIMITED TO, PROCUREMENT OF SUBSTITUTE GOODS OR SERVICES; LOSS OF USE, DATA, OR PROFITS; OR BUSINESS INTERRUPTION) HOWEVER CAUSED AND ON ANY THEORY OF LIABILITY, WHETHER IN CONTRACT, STRICT LIABILITY, OR TORT (INCLUDING NEGLIGENCE OR OTHERWISE) ARISING IN ANY WAY OUT OF THE USE OF THIS SOFTWARE, EVEN IF ADVISED OF THE POSSIBILITY OF SUCH DAMAGE.

#### Part 8: Apple Inc. copyright notice (BSD)

Copyright (c) 2007 Apple Inc.

All rights reserved.

Redistribution and use in source and binary forms, with or without modification, are permitted provided that the following conditions are met:

1. Redistributions of source code must retain the above copyright notice, this list of conditions and the following disclaimer.
2. Redistributions in binary form must reproduce the above copyright notice, this list of conditions and the following disclaimer in the documentation and/or other materials provided with the distribution. 3. Neither the name of Apple Inc. ("Apple") nor the names of its contributors may be used to endorse or promote products derived from this software without specific prior written permission.

THIS SOFTWARE IS PROVIDED BY APPLE AND ITS CONTRIBUTORS "AS IS" AND ANY EXPRESS OR IMPLIED WARRANTIES, INCLUDING, BUT NOT LIMITED TO, THE IMPLIED WARRANTIES OF MERCHANTABILITY AND FITNESS FOR A PARTICULAR PURPOSE ARE DISCLAIMED. IN NO EVENT SHALL APPLE OR ITS CONTRIBUTORS BE LIABLE FOR ANY DIRECT, INDIRECT, INCIDENTAL, SPECIAL, EXEMPLARY, OR CONSEQUENTIAL DAMAGES (INCLUDING, BUT NOT LIMITED TO, PROCUREMENT OF SUBSTITUTE GOODS OR SERVICES; LOSS OF USE, DATA, OR PROFITS; OR BUSINESS INTERRUPTION) HOWEVER CAUSED AND ON ANY THEORY OF LIABILITY, WHETHER IN CONTRACT, STRICT LIABILITY, OR TORT (INCLUDING NEGLIGENCE OR OTHERWISE) ARISING IN ANY WAY OUT OF THE USE OF THIS SOFTWARE, EVEN IF ADVISED OF THE POSSIBILITY OF SUCH DAMAGE.

#### Part 9: ScienceLogic, LLC copyright notice(BSD)

Copyright (c) 2009, ScienceLogic, LLC

All rights reserved.

Redistribution and use in source and binary forms, with or without modification, are permitted provided that the following conditions aremet: yy Redistributions of source code must retain the above copyright notice, this list of conditions and the following disclaimer. yy Redistributions in binary form must reproduce the above copyright notice, this list of conditions and the following disclaimer in the documentation and/or other materials provided with the distribution. yy Neither the name of ScienceLogic, LLC nor the names of its contributors may be used to endorse or promote products derived from this software without specific prior written permission.

THIS SOFTWARE IS PROVIDED BY THE COPYRIGHT HOLDERS AND CONTRIBUTORS "AS IS" AND ANY EXPRESS OR IMPLIED WARRANTIES, INCLUDING, BUT NOT LIMITED TO, THE IMPLIED WARRANTIES OF MERCHANTABILITY AND FITNESS FOR A PARTICULAR PURPOSE ARE DISCLAIMED. IN NO EVENT SHALL THE COPYRIGHT HOLDERS OR CONTRIBUTORS BE LIABLE FOR ANY DIRECT, INDIRECT, INCIDENTAL, SPECIAL, EXEMPLARY, OR CONSEQUENTIAL DAMAGES (INCLUDING, BUT NOT LIMITED TO, PROCUREMENT OF SUBSTITUTE GOODS OR SERVICES; LOSS OF USE, DATA, OR PROFITS; OR BUSINESS INTERRUPTION) HOWEVER CAUSED AND ON ANY THEORY OF LIABILITY, WHETHER IN CONTRACT, STRICT LIABILITY, OR TORT (INCLUDING NEGLIGENCE OR OTHERWISE) ARISING IN ANY WAY OUT OF THE USE OF THIS SOFTWARE, EVEN IF ADVISED OF THE POSSIBILITY OF SUCH DAMAGE

## The MIT License

Some software components of this product incorporate source code covered under the MIT license as follows

### MIT License 2.0

- Acedwidet, bettermeans, jquery-ui, libxml, libxml2, Mesa3D-MesaLib,mwEmbed,OpenGL Samples Pack, Wide Studio, xorg-server, dropbear-2012.55, ncurses-5.7

Copyright (c) 2011, The Dojo Foundation

Copyright 2010, AUTHORS.txt (<http://jqueryui.com/about>)

Dual licensed under the MIT or GPL Version 2 licenses.

- <http://jquery.org/license>

- <http://docs.jquery.com/UI/Widget>

Copyright Daniel Veillard

Copyright Igor Zlatovic <[igor@zlatovic.com](mailto:igor@zlatovic.com)>

Copyright Aleksey Sanin

Copyright Gary Pennington <[Gary.Pennington@uk.sun.com](mailto:Gary.Pennington@uk.sun.com)>

Copyright Alfred Mickautsch <[alfred@mickautsch.de](mailto:alfred@mickautsch.de)>

Copyright Bjorn Reese <[bjorn.reese@systematic.dk](mailto:bjorn.reese@systematic.dk)>

Copyright Joel W. Reed

Copyright William Brack <[wbrack@mmm.com.hk](mailto:wbrack@mmm.com.hk)>

Copyright (c) 2007-2010 The Khronos Group Inc.

Copyright Atish Kumar Patra

Copyright (c) 2006 Free Software Foundation, Inc.

Permission is hereby granted, free of charge, to any person obtaining a copy of this software and associated documentation files (the "Software"), to deal in the Software without restriction, including without limitation the rights to use, copy, modify, merge, publish, distribute, sublicense, and/or sell copies of the Software, and to permit persons to whom the Software is furnished to do so, subject to the following conditions:

The above copyright notice and this permission notice shall be included in all copies or substantial portions of the Software.

THE SOFTWARE IS PROVIDED "AS IS", WITHOUT WARRANTY OF ANY KIND, EXPRESS OR IMPLIED, INCLUDING BUT NOT LIMITED TO THE WARRANTIES OF MERCHANTABILITY, FITNESS FOR A PARTICULAR PURPOSE AND NONINFRINGEMENT. IN NO EVENT SHALL THE AUTHORS OR COPYRIGHT HOLDERS BE LIABLE FOR ANY CLAIM, DAMAGES OR OTHER LIABILITY, WHETHER IN AN ACTION OF CONTRACT, TORT OR OTHERWISE, ARISING FROM, OUT OF OR IN CONNECTION WITH THE SOFTWARE OR THE USE OR OTHER DEALINGS IN THE SOFTWARE.

## Mozilla Public License

Since we, at Hanwha Techwin, used the Mozilla Firefox component without modifying the source code according to the MOZILLA Public license 1.1, we are not obliged to provide the source code of the corresponding component.

- Version 1.1

### 1. Definitions.

1.0.1. "Commercial Use" means distribution or otherwise making the Covered Code available to a third party.

1.1. "Contributor" means each entity that creates or contributes to the creation of Modifications.

1.2. "Covered Code" means the combination of the Original Code, prior Modifications used by a Contributor, and the Modifications made by that particular Contributor.

1.3. "Derived Code" means the Original Code or Modifications or the combination of the Original Code and Modifications, in each case including portions thereof.

1.4. "Electronic Distribution Mechanism" means a mechanism generally accepted in the software development community for the electronic transfer of data.

1.5. "Executable" means Covered Code in any form other than Source Code.

1.6. "Initial Developer" means the individual or entity identified as the Initial Developer in the Source Code notice required by Exhibit A.

1.7. "Larger Work" means a work which combines Covered Code or portions thereof with code not governed by the terms of this License.

1.8. "License" means this document.

1.8.1. "Licensable" means having the right to grant, to the maximum extent possible, whether at the time of the initial grant or subsequently acquired, any and all of the rights conveyed herein.

1.9. "Modifications" means any addition to or deletion from the substance or structure of either the Original Code or any previous Modifications. When Covered Code is released as a series of files, a Modification is:

A. Any addition to or deletion from the contents of a file containing Original Code or previous Modifications.

B. Any new file that contains any part of the Original Code or previous Modifications.

1.10. "Original Code" means Source Code of computer software code which is described in the Source Code notice required by Exhibit A as Original Code, and which, at the time of its release under this License is not already Covered Code governed by this License.

1.10.1. "Patent Claims" means any patent claim(s), now owned or hereafter acquired, including without limitation, method, process, and apparatus claims, in any patent Licensable by grantor.

**1.11.** "Source Code" means the preferred form of the Covered Code for making modifications to it, including all modules it contains, plus any associated interface definition files, scripts used to control compilation and installation of an Executable, or source code differential comparisons against either the Original Code or another well known, available Covered Code of the Contributor's choice. The Source Code can be in a compressed or archival form, provided the appropriate decompression or de-archiving software is widely available for no charge.

**1.12.** "You" (or "Your") means an individual or a legal entity exercising rights under, and complying with all of the terms of, this License or a future version of this License issued under Section 6.1. For legal entities, "You" includes any entity which controls, is controlled by, or is under common control with You. For purposes of this definition, "control" means (a) the power, direct or indirect, to cause the direction or management of such entity, whether by contract or otherwise, or (b) ownership of more than fifty percent (50%) of the outstanding shares or beneficial ownership of such entity.

## 2. Source Code License.

**2.1.** The Initial Developer Grant. The Initial Developer hereby grants You a world-wide, royalty-free, non-exclusive license, subject to third party intellectual property claims:

- (a) under intellectual property rights (other than patent or trademark) licensable by Initial Developer to use, reproduce, modify, display, perform, sublicense and distribute the Original Code (or portions thereof) with or without Modifications, and/or as part of a Larger Work; and
- (b) under Patents Claims infringed by the making, using or selling of Original Code, to make, have made, use, practice, sell, and offer for sale, and/or otherwise dispose of the Original Code (or portions thereof).
- (c) the licenses granted in this Section 2.1(a) and (b) are effective on the date Initial Developer first distributes Original Code under the terms of this License.
- (d) Notwithstanding Section 2.1(b) above, no patent license is granted: 1) for that code that You delete from the Original Code; 2) separate from the Original Code; or 3) for infringements caused by: i) the modification of the Original Code or ii) the combination of the Original Code with other software or devices.

**2.2.** Contributor Grant. Subject to third party intellectual property claims, each Contributor hereby grants You a world-wide, royalty-free, non-exclusive license

- (a) under intellectual property rights (other than patent or trademark) licensable by Contributor, to use, reproduce, modify, display, perform, sublicense and distribute the Modifications created by such Contributor (or portions thereof) either on an unmodified basis, with other Modifications, as Covered Code and/or as part of a Larger Work; and
- (b) under Patent Claims infringed by the making, using, or selling of Modifications made by that Contributor either alone and/or in combination with its Contributor Version (or portions of such combination), to make, use, sell, offer for sale, have made, and/or otherwise dispose of: 1) Modifications made by that Contributor (or portions thereof); and 2) the combination of Modifications made by that Contributor with its Contributor Version (or portions of such combination).
- (c) the licenses granted in Sections 2.2(a) and 2.2(b) are effective on the date Contributor first makes Commercial Use of the Covered Code.
- (d) Notwithstanding Section 2.2(b) above, no patent license is granted: 1) for any code that Contributor has deleted from the Contributor Version; 2) separate from the Contributor Version; 3) for infringements caused by: i) third party modifications of Contributor Version or ii) the combination of Modifications made by that Contributor with other software (except as part of the Contributor Version) or other devices; or 4) under Patent Claims infringed by Covered Code in the absence of Modifications made by that Contributor.

## 3. Distribution Obligations.

**3.1.** Application of License. The Modifications which you create or to which you contribute are governed by the terms of this License, including without limitation Section 2.2. The Source Code version of Covered Code may be distributed only under the terms of this License or a future version of this License released under Section 6.1, and You must include a copy of this License with every copy of the Source Code you distribute. You may not offer or impose any terms on any Source Code version that alters or restricts the applicable version of this License or the recipients' rights hereunder. However, You may include an additional document offering the additional rights described in Section 3.5.

**3.2.** Availability of Source Code. Any Modification which You create or to which You contribute must be made available in Source Code form under the terms of this License either on the same media as an Executable version or via an accepted Electronic Distribution Mechanism to anyone to whom you made an Executable version available; and if made available via Electronic Distribution Mechanism, must remain available for at least twelve (12) months after the date it initially became available, or at least six (6) months after a subsequent version of that particular Modification has been made available to such recipients. You are responsible for ensuring that the Source Code version remains available even if the Electronic Distribution Mechanism is maintained by a third party.

**3.3.** Description of Modifications. You must cause all Covered Code to which You contribute to contain a file documenting the changes You made to create that Covered Code and the date of any change. You must include a prominent statement that the Modification is derived, directly or indirectly, from Original Code provided by the Initial Developer and including the name of the Initial Developer in (a) the Source Code, and (b) in any notice in an Executable version or related documentation in which You describe the origin or ownership of the Covered Code.

## 3.4. Intellectual Property Matters

- (a) Third Party Claims. If Contributor has knowledge that a license under a third party's intellectual property rights is required to exercise the rights granted by such Contributor under Sections 2.1 or 2.2, Contributor must include a text file with the Source Code distribution titled "LEGAL" which describes the claim and the party making the claim in sufficient detail that a recipient will know whom to contact. If Contributor obtains such knowledge after the Modification is made available as described in Section 3.2, Contributor shall promptly modify the LEGAL file in all copies Contributor makes available thereafter and shall take other steps (such as notifying appropriate mailing lists or newsgroups) reasonably calculated to inform those who received the Covered Code that new knowledge has been obtained.
- (b) Contributor APIs. If Contributor's Modifications include an application programming interface and Contributor has knowledge of patent licenses which are reasonably necessary to implement that API, Contributor must also include this information in the LEGAL file.
- (c) Representations.

Contributor represents that, except as disclosed pursuant to Section 3.4(a) above, Contributor believes that Contributor's Modifications are Contributor's original creation(s) and/or Contributor has sufficient rights to grant the rights conveyed by this License.

**3.5.** Required Notices. You must duplicate the notice in Exhibit A in each file of the Source Code. If it is not possible to put such notice in a particular Source Code file due to its structure, then You must include such notice in a location (such as a relevant directory) where a user would be likely to look for such a notice. If You created one or more Modifications(s) You may add your name as a Contributor to the notice described in Exhibit A. You must also duplicate this License in any documentation for the Source Code where You describe recipients' rights or ownership rights relating to Covered Code. You may choose to offer, and to charge a fee for, warranty, support, indemnity or liability obligations to one or more recipients of Covered Code. However, You may do so only on Your own behalf, and not on behalf of the Initial Developer or any Contributor. You must make it absolutely clear that any such warranty, support, indemnity or liability obligation is offered by You alone, and You hereby agree to indemnify the Initial Developer and every Contributor for any liability incurred by the Initial Developer or such Contributor as a result of warranty, support, indemnity or liability terms You offer.

**3.6.** Distribution of Executable Versions. You may distribute Covered Code in Executable form only if the requirements of Section 3.1-3.5 have been met for that Covered Code, and if You include a notice stating that the Source Code version of the Covered Code is available under the terms of this License, including a description of how and where You have fulfilled the obligations of Section 3.2. The notice must be conspicuously included in any notice in an Executable version, related documentation or collateral in which You describe recipients' rights relating to the Covered Code. You may distribute the Executable version of Covered Code or ownership rights under a license of Your choice, which may contain terms different from this License, provided that You are in compliance with the terms of this License and that the license

for the Executable version does not attempt to limit or alter the recipient's rights in the Source Code version from the rights set forth in this License. If You distribute the Executable version under a different license You must make it absolutely clear that any terms which differ from this License are offered by You alone, not by the Initial Developer or any Contributor. You hereby agree to indemnify the Initial Developer and every Contributor for any liability incurred by the Initial Developer or such Contributor as a result of any such terms You offer.

**3.7.** Larger Works. You may create a Larger Work by combining Covered Code with other code not governed by the terms of this License and distribute the Larger Work as a single product. In such a case, You must make sure the requirements of this License are fulfilled for the Covered Code.

## 4. Inability to Comply Due to Statute or Regulation.

If it is impossible for You to comply with any of the terms of this License with respect to some or all of the Covered Code due to statute, judicial order, or regulation then You must: (a) comply with the terms of this License to the maximum extent possible; and (b) describe the limitations and the code they affect. Such description must be included in the LEGAL file described in Section 3.4 and must be included with all distributions of the Source Code. Except to the extent prohibited by statute or regulation, such description must be sufficiently detailed for a recipient of ordinary skill to be able to understand it.

## 5. Application of this License.

This License applies to code to which the Initial Developer has attached the notice in Exhibit A and to related Covered Code.

## 6. Versions of the License.

**6.1.** New Versions. Netscape Communications Corporation ("Netscape") may publish revised and/or new versions of the License from time to time. Each version will be given a distinguishing version number.

**6.2.** Effect of New Versions. Once Covered Code has been published under a particular version of the License, You may always continue to use it under the terms of that version. You may also choose to use such Covered Code under the terms of any subsequent version of the License published by Netscape. No one other than Netscape has the right to modify the terms applicable to Covered Code created under this License.

**6.3.** Derivative Works. If You create or use a modified version of this License (which you may only do in order to apply it to code which is not already Covered Code governed by this License), You must (a) rename your license so that the phrases "Mozilla", "MOZILLAPL", "MOZPL", "Netscape", "MPL", "NPL" or any confusingly similar phrase do not appear in your license (except to note that your license differs from this License) and (b) otherwise make it clear that Your version of the license contains terms which differ from the Mozilla Public License and Netscape Public License. (Filing in the name of the Initial Developer, Original Code or Contributor in the notices described in Exhibit A shall not of themselves be deemed to be modifications of this License.)

## 7. DISCLAIMER OF WARRANTY.

COVERED CODE IS PROVIDED UNDER THIS LICENSE ON AN "AS IS" BASIS, WITHOUT WARRANTY OF ANY KIND, EITHER EXPRESSED OR IMPLIED, INCLUDING, WITHOUT LIMITATION, WARRANTIES THAT THE COVERED CODE IS FREE OF DEFECTS, MERCHANTABILITY, FIT FOR A PARTICULAR PURPOSE OR NON-INFRINGEMENT. THE ENTIRE RISK AS TO THE QUALITY AND PERFORMANCE OF THE COVERED CODE IS WITH YOU. SHOULD ANY COVERED CODE PROVE DEFECTIVE IN ANY RESPECT, YOU (NOT THE INITIAL DEVELOPER OR ANY OTHER CONTRIBUTOR) ASSUME THE COST OF ANY NECESSARY SERVICING, REPAIR OR CORRECTION. THIS DISCLAIMER OF WARRANTY CONSTITUTES AN ESSENTIAL PART OF THIS LICENSE. NO USE OF ANY COVERED CODE IS AUTHORIZED HEREUNDER EXCEPT UNDER THIS DISCLAIMER.

## 8. TERMINATION.

**8.1.** This License and the rights granted hereunder will terminate automatically if You fail to comply with terms herein and fail to cure such breach within 30 days of becoming aware of the breach. All sublicenses to the Covered Code which are properly granted shall survive any termination of this License. Provisions which, by their nature, must remain in effect beyond the termination of this License shall survive.

**8.2.** If You initiate litigation by asserting a patent infringement claim (excluding declaratory judgment actions) against Initial Developer or a Contributor (the Initial Developer or Contributor against whom You file such action is referred to as "Participant") alleging that:

- (a) such Participant's Contributor Version directly or indirectly infringes any patent, then any and all rights granted by such Participant to You under Sections 2.1 and/or 2.2 of this License shall, upon 60 days notice from Participant terminate prospectively, unless if within 60 days after receipt of notice You either: (i) agree in writing to pay Participant a mutually agreeable reasonable royalty for Your past and future use of Modifications made by such Participant, or (ii) withdraw Your litigation claim with respect to the Contributor Version against such Participant. If within 60 days of notice, a reasonable royalty and payment arrangement are not mutually agreed upon in writing by the parties or the litigation claim is not withdrawn, the rights granted by Participant to You under Sections 2.1 and/or 2.2 automatically terminate at the expiration of the 60 day notice period specified above.

- (b) any software, hardware, or device, other than such Participant's Contributor Version, directly or indirectly infringes any patent, then any rights granted to You by such Participant under Sections 2.1(b) and 2.2(b) are revoked effective as of the date You first made, used, sold, distributed, or had made, Modifications made by that Participant.

**8.3.** If You assert a patent infringement claim against Participant alleging that such Participant's Contributor Version directly or indirectly infringes any patent where such claim is resolved (such as by license or settlement) prior to the initiation of patent infringement litigation, then the reasonable value of the licenses granted by such Participant under Sections 2.1 or 2.2 shall be taken into account in determining the amount or value of any payment or license.

**8.4.** In the event of termination under Sections 8.1 or 8.2 above, all end user license agreements (excluding distributors and resellers) which have been validly granted by You or any distributor hereunder prior to termination shall survive termination.

## 9. LIMITATION OF LIABILITY.

UNDER NO CIRCUMSTANCES AND UNDER NO LEGAL THEORY, WHETHER TORT (INCLUDING NEGLIGENCE), CONTRACT, OR OTHERWISE, SHALL YOU, THE INITIAL DEVELOPER, ANY OTHER CONTRIBUTOR, OR ANY DISTRIBUTOR OF COVERED CODE, OR ANY SUPPLIER OF ANY OF SUCH PARTIES, BE LIABLE TO ANY PERSON FOR ANY INDIRECT, SPECIAL, INCIDENTAL, OR CONSEQUENTIAL DAMAGES OF ANY CHARACTER INCLUDING, WITHOUT LIMITATION, DAMAGES FOR LOSS OF GOODWILL, WORK STOPPAGE, COMPUTER FAILURE OR MALFUNCTION, OR ANY AND ALL OTHER COMMERCIAL DAMAGES OR LOSSES, EVEN IF SUCH PARTY SHALL HAVE BEEN INFORMED OF THE POSSIBILITY OF SUCH DAMAGES. THIS LIMITATION OF LIABILITY SHALL NOT APPLY TO LIABILITY FOR DEATH OR PERSONAL INJURY RESULTING FROM SUCH PARTY'S NEGLIGENCE TO THE EXTENT APPLICABLE LAW PROHIBITS SUCH LIMITATION. SOME JURISDICTIONS DO NOT ALLOW THE EXCLUSION OR LIMITATION OF INCIDENTAL OR CONSEQUENTIAL DAMAGES. SO THIS EXCLUSION AND LIMITATION MAY NOT APPLY TO YOU. 10. U.S. GOVERNMENT END USERS.

The Covered Code is a "commercial item," as that term is defined in 48 C.F.R. 2.101 (Oct. 1995), consisting of "commercial computer software" and "commercial computer software documentation," as such terms are used in 48 C.F.R. 12.212 (Sept. 1995). Consistent with 48 C.F.R. 12.212 and 48 C.F.R. 227.7202-1 through 227.7202-4 (June 1995), all U.S. Government End Users acquire Covered Code with only those rights set forth herein.

## 11. MISCELLANEOUS.

This License represents the complete agreement concerning subject matter hereof. If any provision of this License is held to be unenforceable, such provision shall be reformed only to the extent necessary to make it enforceable. This License shall be governed by California law provisions (except to the extent applicable law, if any, provides otherwise), excluding its conflict-of-law provisions. With respect to disputes in which at least one party is a citizen of, or an entity chartered or registered to do business in the United States of America, any litigation relating to this License shall be subject to the jurisdiction of the Federal Courts of the Northern District of California, with venue lying in Santa Clara County, California, with the losing party responsible for costs, including without limitation, court costs and reasonable attorneys' fees and expenses. The application of the United Nations Convention on Contracts for the International Sale of Goods is expressly excluded. Any law or regulation which

provides that the language of a contract shall be construed against the drafter shall not apply to this License.

## 12. RESPONSIBILITY FOR CLAIMS.

As between Initial Developer and the Contributors, each party is responsible for claims and damages arising, directly or indirectly, out of its utilization of rights under this License and You agree to work with Initial Developer and Contributors to distribute such responsibility on an equitable basis. Nothing herein is intended or shall be deemed to constitute any admission of liability.

## 13. MULTIPLE-LICENSED CODE.

Initial Developer may designate portions of the Covered Code as Multiple-Licensed. Multiple-Licensed means that the Initial Developer permits you to utilize portions of the Covered Code under Your choice of the MPL or the alternative licenses, if any, specified by the Initial Developer in the file described in Exhibit A.

### EXHIBIT A -Mozilla Public License.

The contents of this file are subject to the Mozilla Public License Version 1.1 (the "License"); you may not use this file except in compliance with the License. You may obtain a copy of the License at <http://www.mozilla.org/MPL/Software> distributed under the License is distributed on an "AS IS" basis, WITHOUT WARRANTY OF ANY KIND, either express or implied. See the License for the specific language governing rights and limitations under the License.

The Original Code is \_\_\_\_\_.

The Initial Developer of the Original Code is \_\_\_\_\_; Portions created by \_\_\_\_\_ are Copyright (C) \_\_\_\_\_, All Rights Reserved.

Contributor(s): \_\_\_\_\_.

Alternatively, the contents of this file may be used under the terms of the \_\_\_\_\_ license (the [\_\_\_\_\_] License), in which case the provisions of [\_\_\_\_\_] License are applicable instead of those above. If you wish to allow use of your version of this file only under the terms of the [\_\_\_\_\_] License and not to allow others to use your version of this file under the MPL, indicate your decision by deleting the provisions above and replace them with the notice and other provisions required by the [\_\_\_\_\_] License. If you do not delete the provisions above, a recipient may use your version of this file under either the MPL or the [\_\_\_\_\_] License.\*

[NOTE: The text of this Exhibit A may differ slightly from the text of the notices in the Source Code files of the Original Code. You should use the text of this Exhibit A rather than the text found in the Original Code Source Code for Your Modifications

## The Independent JPEG Group's JPEG Software

The software included in this product contains copyrighted software that is licensed under the JPEG license.

- JPEG license
- Code project . Generating Outline OpenGL, Libjpeg

This distribution contains the sixth public release of the Independent JPEG Group's free JPEG software. You are welcome to redistribute this software and to use it for any purpose, subject to the conditions under LEGAL ISSUES, below.

Serious users of this software (particularly those incorporating it into larger programs) should contact IJG at [jpeg-info@uunet.uu.net](mailto:jpeg-info@uunet.uu.net) to be added to our electronic mailing list. Mailing list members are notified of updates and have a chance to participate in technical discussions, etc.

This software is the work of Tom Lane, Philip Gladstone, Jim Boucher, Lee Crocker, Julian Minguijon, Luis Ortiz, George Phillips, Davide Rossi, Guido Vollbeding, Ge' Weijers, and other members of the Independent JPEG Group.

IJG is not affiliated with the official ISO JPEG standards committee.

## LEGAL ISSUES

=====

### In plain English:

1. We don't promise that this software works. (But if you find any bugs, please let us know!)
2. You can use this software for whatever you want. You don't have to pay us.
3. You may not pretend that you wrote this software. If you use it in a program, you must acknowledge somewhere in your documentation that you've used the IJG code.

### In legalese:

The authors make NO WARRANTY or representation, either express or implied, with respect to this software, its quality, accuracy, merchantability, or fitness for a particular purpose. This software is provided "AS IS", and you, its user, assume the entire risk as to its quality and accuracy.

This software is copyright (C) 1991-1998, Thomas G. Lane. All Rights Reserved except as specified below.

Permission is hereby granted to use, copy, modify, and distribute this software (or portions thereof) for any purpose, without fee, subject to these conditions:

- (1) If any part of the source code for this software is distributed, then this README file must be included, with this copyright and no-warranty notice unaltered; and any additions, deletions, or changes to the original files must be clearly indicated in accompanying documentation.
- (2) If only executable code is distributed, then the accompanying documentation must state that "this software is based in part on the work of the Independent JPEG Group".
- (3) Permission for use of this software is granted only if the user accepts full responsibility for any undesirable consequences; the authors accept NO LIABILITY for damages of any kind.

These conditions apply to any software derived from or based on the IJG code, not just to the unmodified library. If you use our work, you ought to acknowledge us.

Permission is NOT granted for the use of any IJG author's name or company name in advertising or publicity relating to this software or products derived from it. This software may be referred to only as "the Independent JPEG Group's software".

We specifically permit and encourage the use of this software as the basis of commercial products, provided that all warranty or liability claims are assumed by the product vendor.

ansi2knr.c is included in this distribution by permission of L. Peter Deutsch, sole proprietor of its copyright holder, Aladdin Enterprises of Menlo Park, CA.

ansi2knr.c is NOT covered by the above copyright and conditions, but instead by the usual distribution terms of the Free Software Foundation; principally, that you must include source code if you redistribute it. (See the file ansi2knr.c for full details.) However, since ansi2knr.c is not needed as part of any program generated from the IJG code, this does not limit you more than the foregoing paragraphs do.

The Unix configuration script "configure" was produced with GNU Autoconf. It is copyright by the Free Software Foundation but is freely distributable. The same holds for its supporting scripts (config.sub, ltcconfig, ltmain.sh). Another support script, install-sh, is copyright by M.I.T. but is also freely distributable.

It appears that the arithmetic coding option of the JPEG spec is covered by patents owned by IBM, AT&T, and Mitsubishi. Hence arithmetic coding cannot legally be used without obtaining one or more licenses. For this reason, support for arithmetic coding has been removed from the free JPEG software. (Since arithmetic coding provides only a marginal gain over the unpatented Huffman mode, it is unlikely that very many implementations will support it.) So far as we are aware, there are no patent restrictions on the remaining code.

The IJG distribution formerly included code to read and write GIF files. To avoid entanglement with the Unisys LZW patent, GIF reading support has been removed altogether, and the GIF writer has been simplified to produce "uncompressed GIFs". This technique does not use the LZW algorithm; the resulting GIF files are larger than usual, but are readable by all standard GIF decoders.

We are required to state that

\*The Graphics Interchange Format(c) is the Copyright property of CompuServe Incorporated. GIF(sm) is a Service Mark property of CompuServe Incorporated.\*

## T-Kernel License

---

- This Product uses the Source Code of T-Kernel under T-License granted by the T-Engine Forum([www.t-engine.org](http://www.t-engine.org))

---

### T-License [License Agreement for Source Code of T-Kernel]

established by T-Engine Forum  
on January 23, 2004  
revised on June 17, 2004  
revised on December 21, 2006  
revised on March 24, 2009

### Article 1. Scope of License Agreement

1. This License Agreement sets forth copyrights and the terms and conditions of use applicable to the source code of T-Kernel distributed by T-Engine Forum and any derivative work created therefrom.

### Article 2. Definition

1. "T-Kernel" means a real-time operating system controlled and distributed by T-Engine Forum on behalf of the copyright holder thereof.
2. "Source Code" means a source program, including related comments and documentations, for the T-Kernel and the Ported Source Code defined in Article 2.8 which is registered with T-Engine Forum.
3. "Hardware-dependent Part" means the part of the Source Code which depends on hardware and needs to be changed when the Source Code is ported and operated on the target hardware, and is designated and separated as such part.
4. "Compiler-dependent Part" means the part of the Source Code which depends on compiler and needs to be changed when the Source Code is ported and operated on the target hardware, and is designated and separated as such part.
5. "Header File" means the part of the Source Code which contains definitions necessary to develop application programs.
6. "T-Engine Hardware" means the hardware which is manufactured in accordance with the T-Engine Hardware specifications or the  $\mu$ T-Engine Hardware specifications issued by T-Engine Forum, and registered with T-Engine Forum.
7. "Similar Hardware to T-Engine Hardware" means any hardware (including software which emulates hardware) other than that defined in Article 2.6 above, on which the T-Kernel can be operated.
8. "Ported Source Code" means a source program produced from the Source Code by modifying only its Hardware-dependent Part and/or Compiler-dependent Part to enable it to be operated on the T-Engine Hardware or the Similar Hardware to T-Engine Hardware. The Ported Source Code which is registered with T-Engine Forum shall be included in the Source Code.
9. "Modified Source Code" means a source program modified from the Source Code for the purpose of improving its performance, increasing or decreasing its function, and the like. The Ported Source Code shall not be included in the Modified Source Code.
10. "Binary Code" means an executable code form which is created by compiling programs, which include all or part of the Source Code or the Modified Source Code.
11. "Derivative Work" means the Modified Source Code or the Binary Code.
12. "Embedded Product" means any product which operates with executable code form of the Source Code, the Modified Source Code or the Binary Code loaded on its hardware.
13. "End User" means a consumer who uses the Embedded Product.
14. "System Developer" means any person who develops the Embedded Product by itself or has a third party develop the same, and provides, whether with or without payment, the End User with the Embedded Product.
15. "Distributor of Modification" means any person who produces the Modified Source Code and, whether with or without payment, distributes the same to any third party.

**16.** "Patch for Modification" means a difference, program, system, or the like in order to create the Modified Source Code from the Source Code or the Binary Code thereof.

**17.** "Vicarious Execution of Patch Processing" means vicarious execution service to create the Modified Source Code applying the Patch for Modification to the Source Code or the Binary Code thereof.

**18.** "Source Code User" means a person who uses the Source Code.

**19.** "Distribution" means any of the following acts:

1. to transmit a work to a large number of specific persons through the Internet communication, broadcasting, and the like;
2. to transmit a work to the general public through the Internet communication, broadcasting, and the like automatically in response to a request from the public; and
3. to distribute a copy of a work to the general public or a large number of specific persons.

#### **Article 3. Copyright**

1. The copyrights of the Source Code shall be owned by Ken Sakamura.

#### **Article 4. License of Source Code**

1. As provided for in this Article, T-Engine Forum shall provide, and grant a license to use, the Source Code free of charge to any person who has taken the necessary procedure for registration as prescribed by T-Engine Forum and agreed to the T-License.

2. The Source Code shall be distributed exclusively by T-Engine Forum. Any person who obtains the Source Code under Article 4.1 above shall not make any re-Distribution of the Source Code.

3. In accordance with the license granted under Article 4.1 above, the Source Code User may perform the following acts:

1. to copy and/or modify the Source Code provided by T-Engine Forum hereunder for its own research, development and the like.
  2. to run the Source Code provided by T-Engine Forum hereunder for its own research, development and the like.
  3. to run the Source Code modified in accordance with the provision of Article 4.3 (1) above for its own research, development and the like.
  4. to distribute the Binary Code created from the Source Code provided by T-Engine Forum hereunder or from the Source Code modified in accordance with the provision of Article 4.3 (1) above.
4. In accordance with the license granted under Article 4.1 above, the System Developer may perform the following acts:

1. to perform any and all acts set forth in the Article 4.3 above.
2. to develop and manufacture the Embedded Product containing the Binary Code, and, whether with or without payment, provide the End User with the same and make the Binary Code available to the End User on the Embedded Product.

5. The Source Code User and the System Developer shall be obligated to give a notice that the Source Code is used, in such a way as separately specified by T-Engine Forum, when they use the Source Code or the Binary Code, or make the Binary Code available for the End User on the Embedded Product.

#### **Article 5. Distribution of Modified Source Code**

1. Any of A- members of T-Engine Forum may become the Distributor of Modification by obtaining the approval of T-Engine Forum through the registration procedure as prescribed by the Forum provided that only the department of the A- member which has taken the registration procedure may distribute the Modified Source Code in such a way as provided for in this Article as long as it holds the Amembership.

2. The Distributor of Modification may create the Modified Source Code based on the Source Code provided by T-Engine Forum and the Patch for Modification to be applied to create such Modified Source Code from the Source Code.

3. The Distributor of Modification shall, prior to the distribution, inform T-Engine Forum of and register a name and description of the Modified Source Code in such a way as specified by T-Engine Forum.

4. The Distributor of Modification shall determine the name of the Modified Source Code subject to the rules separately established by T-Engine Forum and publish an appropriate notice as required by the rules on the Patch for Modification and the Modified Source Code.

5. The Distributor of Modification may distribute the Modified Source Code to a third party, whether with or without payment, provided that the Distributor of Modification shall take the necessary measures to prohibit the third party from making the re-Distribution of the Modified Source Code.

6. Developer with the Patch for Modification. Provided, however, that the Distributor of Modification shall be obligated to confirm that the System Developer is the Source Code User duly licensed under Article 4.1.

7. The Distributor of Modification may perform the Vicarious Execution of Patch Processing for the System Developer.

8. The System Developer shall not distribute the Modified Source Code in further modified form to any third party as a stand-alone software product.

9. The System Developer may, under the same obligation as imposed in Article 4.5, make the Embedded Product available for the End User through use of the Patch for Modification distributed by the Distributor of Modification or the Derivative Works obtained through the Vicarious Execution of Patch Processing.

#### **Article 6. Distribution and Registration of the Ported Source Code**

1. The Source Code User and the System Developer may, whether with or without charge, distribute to any third party only the following parts of the Ported

Source Code on the T-Engine Hardware or the Similar Hardware to T-Engine Hardware:

1. The Hardware-dependent Part and/or Compiler-dependent Part; provided that the Source Code User and the System Developer shall inform T-Engine Forum of, and T-Engine Forum may publish, a method for distributing said Part(s) to third parties.

2. The Header File; provided that the Header File shall be distributed together with the Binary Code of the Ported Source Code.

2. Any member of T-Engine Forum may request T-Engine Forum to register and distribute, as an original source code for T-Kernel, the Ported Source Code on the T-Engine Hardware or the Similar Hardware to T-Engine Hardware.

3. Any member of T-Engine Forum who requests the distribution mentioned in the preceding paragraph shall accede to the following conditions:

1. The member shall confirm that the object hardware is the T-Engine Hardware or the Similar Hardware to T-Engine Hardware.
2. The member shall provide T-Engine Forum with a complete set of operational environment for the object hardware and T-Kernel free of charge when requesting the distribution.
3. The member shall submit test results of the Ported Source Code to T-Engine Forum when requesting the distribution.

4. In the event that T-Engine Forum accepts the request mentioned in Article 6.2, T-Engine Forum shall register and distribute the Ported Source Code as the Source Code for T-Kernel. Provided, however, that the Ported Source Code may be treated in the same way as the Modified Source Code until the time of registration hereunder.

5. The provision set forth in Article 3 shall apply to the Ported Source Code registered in accordance with this Article.

#### **Article 7. Use for Other Purpose**

1. Any use of the Source Code, the Modified Source Code or the Ported Source Code other than those stipulated in Articles 4, 5 and 6 shall be subject to the prior approval of T-Engine Forum.

#### **Article 8. Limited Warranty**

1. T-Engine Forum and the copyright holder of the Source Code warrant that the Source Code does not infringe third party's copyrights. Provided, however, that T-Engine Forum and the copyright holder of the Source Code make no warranty as to the Hardware-dependent Part and/or Compiler-dependent Part set forth in Article 6.2 in the Ported Source Code by any third party.

2. Neither T-Engine Forum nor the copyright holder of the Source Code warrants that the Source Code will fit for any particular purpose of the Source Code User.

3. Neither T-Engine Forum nor the copyright holder of the Source Code warrants that the Source Code does not infringe any third party's industrial property rights. In no event shall T-Engine Forum and the copyright holder of the Source Code be liable for any dispute which may arise between the Source Code User and a third party in connection with the third party's industrial property rights.

#### **Article 9. Indemnity**

1. Neither T-Engine Forum nor the copyright holder of the Source Code shall be liable for any damages (including, but not limited to, damages resulting from loss of profit, business interruption, loss of business information or any other pecuniary damage) arising out of use or impossibility of use of the Source Code, even if T-Engine Forum and the copyright holder have been informed of the possibility of such damages.

#### **Article 10. Breach of Agreement**

1. In case that T-Engine Forum considers that this License Agreement is breached or that the popularization of T-Kernel is obstructed, T-Engine Forum shall take measures to correct such breach or such obstruction, take measures on the ground of copyright infringement, or take any other necessary measures against the breaching person or the obstructing person, regardless of whether or not the said person is a member of T-Engine Forum.

2. In case of breach of this License Agreement by a member of T-Engine Forum, T-Engine Forum may take appropriate measures against the member; for example, the member is disqualified from membership, depending on what kind of breach has been committed by it.

3. Any legal dispute which may arise in relation to any breach of this License Agreement shall be subject to the exclusive jurisdiction of the Tokyo District Court.

#### **Article 11. Governing Law and Language**

1. This License Agreement shall be governed by and interpreted under the laws of Japan.

2. This License Agreement is executed in both Japanese text and English text provided that the Japanese text shall govern the interpretation and performance of this License Agreement.

### **Apache License 2.0**

Component	Name License	URL
mDNSResponder_bonjour	Apache License 2.0	<a href="http://www.apache.org/licenses/LICENSE-2.0">http://www.apache.org/licenses/LICENSE-2.0</a>

#### **TERMS AND CONDITIONS FOR USE, REPRODUCTION, AND DISTRIBUTION**

1. Definitions.

"License" shall mean the terms and conditions for use, reproduction, and distribution as defined by Sections 1 through 9 of this document.

"Licensor" shall mean the copyright owner or entity authorized by the copyright owner that is granting the License.



"Legal Entity" shall mean the union of the acting entity and all other entities that control, are controlled by, or are under common control with that entity. For the purposes of this definition, "control" means (i) the power, direct or indirect, to cause the direction or management of such entity, whether by contract or otherwise, or (ii) ownership of fifty percent (50%) or more of the outstanding shares, or (iii) beneficial ownership of such entity.

"You" (or "Your") shall mean an individual or Legal Entity exercising permissions granted by this License. "Source" form shall mean the preferred form for making modifications, including but not limited to software source code, documentation source, and configuration files.

"Object" form shall mean any form resulting from mechanical transformation or translation of a Source form, including but not limited to compiled object code, generated documentation, and conversions to other media types.

"Work" shall mean the work of authorship, whether in Source or Object form, made available under the License, as indicated by a copyright notice that is included in or attached to the work (an example is provided in the Appendix below).

"Derivative Works" shall mean any work, whether in Source or Object form, that is based on (or derived from) the Work and for which the editorial revisions, annotations, elaborations, or other modifications represent, as a whole, an original work of authorship. For the purposes of this License, Derivative Works shall not include works that remain separable from, or merely link (or bind by name) to the interfaces of, the Work and Derivative Works thereof.

"Contribution" shall mean any work of authorship, including the original version of the Work and any modifications or additions to that Work or Derivative Works thereof, that is intentionally submitted to Licensor for inclusion in the Work by the copyright owner or by an individual or Legal Entity authorized to submit on behalf of the copyright owner. For the purposes of this definition, "submitted" means any form of electronic, verbal, or written communication sent to the Licensor or its representatives, including but not limited to communication on electronic mailing lists, source code control systems, and issue tracking systems that are managed by, or on behalf of, the Licensor for the purpose of discussing and improving the Work, but excluding communication that is conspicuously marked or otherwise designated in writing by the copyright owner as "Not a Contribution." "Contributor" shall mean Licensor and any individual or Legal Entity on behalf of whom a Contribution has been received by Licensor and subsequently incorporated within the Work.

- Grant of Copyright License. Subject to the terms and conditions of this License, each Contributor hereby grants to You a perpetual, worldwide, non-exclusive, no-charge, royalty-free, irrevocable copyright license to reproduce, prepare Derivative Works of, publicly display, publicly perform, sublicense, and distribute the Work and such Derivative Works in Source or Object form.
- Grant of Patent License. Subject to the terms and conditions of this License, each Contributor hereby grants to You a perpetual, worldwide, non-exclusive, no-charge, royalty-free, irrevocable (except as stated in this section) patent license to make, have made, use, offer to sell, sell, import, and otherwise transfer the Work, where such license applies only to those patent claims licensable by such Contributor that are necessarily infringed by their Contribution(s) alone or by combination of their Contribution(s) with the Work to which such Contribution(s) was submitted. If You institute patent litigation against any entity (including a crossclaim or counterclaim in a lawsuit) alleging that the Work or a Contribution incorporated within the Work constitutes direct or contributory patent infringement, then any patent licenses granted to You under this License for that Work shall terminate as of the date such litigation is filed.

- Redistribution. You may reproduce and distribute copies of the Work or Derivative Works thereof in any medium, with or without modifications, and in Source or Object form, provided that You meet the following conditions:

- You must give any other recipients of the Work or Derivative Works a copy of this License; and
- You must cause any modified files to carry prominent notices stating that You changed the files; and
- You must retain, in the Source form of any Derivative Works that You distribute, all copyright, patent, trademark, and attribution notices from the Source form of the Work, excluding those notices that do not pertain to any part of the Derivative Works; and
- If the Work includes a "NOTICE" text file as part of its distribution, then any Derivative Works that You distribute must include a readable copy of the attribution notices contained within such NOTICE file, excluding those notices that do not pertain to any part of the Derivative Works, in at least one of the following places: within a NOTICE text file distributed as part of the Derivative Works; within the Source form or documentation, if provided along with the Derivative Works; or, within a display generated by the Derivative Works, if and wherever such third-party notices normally appear. The contents of the NOTICE file are for informational purposes only and do not modify the License. You may add Your own attribution notices within Derivative Works that You distribute, alongside or as an addendum to the NOTICE text from the Work, provided that such additional attribution notices cannot be construed as modifying the License.

You may add Your own copyright statement to Your modifications and may provide additional or different license terms and conditions for use, reproduction, or distribution of Your modifications, or for any such Derivative Works as a whole, provided Your use, reproduction, and distribution of the Work otherwise complies with the conditions stated in this License.

- Submission of Contributions. Unless You explicitly state otherwise, any Contribution intentionally submitted for inclusion in the Work by You to the Licensor shall be under the terms and conditions of this License, without any additional terms or conditions. Notwithstanding the above, nothing herein shall supersede or modify the terms of any separate license agreement you may have executed with Licensor regarding such Contributions.

- Trademarks. This License does not grant permission to use the trade names, trademarks, service marks, or product names of the Licensor, except as required for reasonable and customary use in describing the origin of the Work and reproducing the content of the NOTICE file.

- Disclaimer of Warranty. Unless required by applicable law or agreed to in writing, Licensor provides the Work (and each Contributor provides its Contributions) on an "AS IS" BASIS, WITHOUT WARRANTIES OR CONDITIONS OF ANY KIND, either express or implied, including, without limitation, any warranties or conditions of TITLE, NON-INFRINGEMENT, MERCHANTABILITY, or FITNESS FOR A PARTICULAR PURPOSE. You are solely responsible for determining the appropriateness of using or redistributing the Work and assume any risks associated with Your exercise of permissions under this License.

- Limitation of Liability. In no event and under no legal theory, whether in tort (including negligence), contract, or otherwise, unless required by applicable law (such as deliberate and grossly negligent acts) or agreed to in writing, shall any Contributor be liable to You for damages, including any direct, indirect, special, incidental, or consequential damages of any character arising as a result of this License or out of the use or inability to use the Work (including but not limited to damages for loss of goodwill, work stoppage, computer failure or malfunction, or any and all other commercial damages or losses), even if such Contributor has been advised of the possibility of such damages.

- Accepting Warranty or Additional Liability. While redistributing the Work or Derivative Works thereof, You may choose to offer, and charge a fee for, acceptance of support, warranty, indemnity, or other liability obligations and/or rights consistent with this License. However, in accepting such obligations, You may act only on Your own behalf and on Your sole responsibility, not on behalf of any other Contributor, and only if You agree to indemnify, defend, and hold each Contributor harmless for any liability incurred by, or claims asserted against, such Contributor by reason of your accepting any such warranty or additional liability.

## END OF TERMS AND CONDITIONS

APPENDIX: How to apply the Apache License to your work.

To apply the Apache License to your work, attach the following boilerplate notice, with the fields enclosed by brackets "[ ]" replaced with your own identifying information. (Don't include the brackets!) The text should be enclosed in the appropriate comment syntax for the file format. We also recommend that a file or class name and description of purpose be included on the same "printed page" as the copyright notice for easier identification within third-party archives.

Copyright [yyyy] [name of copyright owner]

Licensed under the Apache License, Version 2.0 (the "License"); you may not use this file except in compliance with the License. You may obtain a copy of the License at <http://www.apache.org/licenses/LICENSE-2.0>

Unless required by applicable law or agreed to in writing, software distributed under the License is distributed on an "AS IS" BASIS, WITHOUT WARRANTIES OR CONDITIONS OF ANY KIND, either express or implied. See the License for the specific language governing permissions and limitations under the License.

## BZip2 License

This program, "bzip2", the associated library "libbzip2", and all documentation, are copyright (C) 1996-2007 Julian R Seward. All rights reserved.

Component Name	License	URL
bzip2-1.0.5	Bzip2	<a href="http://www.bzip.org/">http://www.bzip.org/</a>

Redistribution and use in source and binary forms, with or without modification, are permitted provided that the following conditions are met:

- Redistributions of source code must retain the above copyright notice, this list of conditions and the following disclaimer.
- The origin of this software must not be misrepresented; you must not claim that you wrote the original software. If you use this software in a product, an acknowledgment in the product documentation would be appreciated but is not required.
- Altered source versions must be plainly marked as such, and must not be misrepresented as being the original software.
- The name of the author may not be used to endorse or promote products derived from this software without specific prior written permission.

THIS SOFTWARE IS PROVIDED BY THE AUTHOR "AS IS" AND ANY EXPRESS OR IMPLIED WARRANTIES, INCLUDING, BUT NOT LIMITED TO, THE IMPLIED WARRANTIES OF MERCHANTABILITY AND FITNESS FOR A PARTICULAR PURPOSE ARE DISCLAIMED. IN NO EVENT SHALL THE AUTHOR BE LIABLE FOR ANY DIRECT, INDIRECT, INCIDENTAL, SPECIAL, EXEMPLARY, OR CONSEQUENTIAL DAMAGES (INCLUDING, BUT NOT LIMITED TO, PROCUREMENT OF SUBSTITUTE GOODS OR SERVICES; LOSS OF USE, DATA, OR PROFITS; OR BUSINESS INTERRUPTION) HOWEVER CAUSED AND ON ANY THEORY OF LIABILITY, WHETHER IN CONTRACT, STRICT LIABILITY, OR TORT (INCLUDING NEGLIGENCE OR OTHERWISE) ARISING IN ANY WAY OUT OF THE USE OF THIS SOFTWARE, EVEN IF ADVISED OF THE POSSIBILITY OF SUCH DAMAGE.

Julian Seward, [jseward@bzip.org](mailto:jseward@bzip.org)

bzip2/libbzip2 version 1.0.5 of 10 December 2007

## University of Illinois / NCSA Open Source License

Copyright (c) 1999-2007, The Board of Trustees of the University of Illinois All Rights Reserved.

Component Name	License
iperf-2.0.5	University of Illinois / NCSA Open Source

iperf performance test

Mark Gates

Ajay Tirumala

Jim Ferguson

Jon Dugan

Feng Qin

Kevin Gibbs

John Estabrook

National Laboratory for Applied Network Research

National Center for Supercomputing Applications

University of Illinois at Urbana-Champaign

<http://www.ncsa.uiuc.edu>

Permission is hereby granted, free of charge, to any person obtaining a copy of this software (iperf) and associated documentation files (the "Software"), to deal in the Software without restriction, including without limitation the rights to use, copy, modify, merge, publish, distribute, sublicense, and/or sell copies of the Software, and to permit persons to whom the Software is furnished to do so, subject to the following conditions:

Redistributions of source code must retain the above copyright notice, this list of conditions and the following disclaimers.

Redistributions in binary form must reproduce the above copyright notice, this list of conditions and the following disclaimers in the documentation and/or other materials provided with the distribution.

Neither the names of the University of Illinois, NCSA, nor the names of its contributors may be used to endorse or promote products derived from this Software without specific prior written permission. THE SOFTWARE IS PROVIDED "AS IS", WITHOUT WARRANTY OF ANY KIND, EXPRESS OR IMPLIED, INCLUDING BUT NOT LIMITED TO THE WARRANTIES OF MERCHANTABILITY, FITNESS FOR A PARTICULAR PURPOSE AND NON-INFRINGEMENT. IN NO EVENT SHALL THE CONTRIBUTORS OR COPYRIGHT HOLDERS BE LIABLE FOR ANY CLAIM, DAMAGES OR OTHER LIABILITY, WHETHER IN AN ACTION OF CONTRACT, TORT OR OTHERWISE, ARISING FROM, OUT OF OR IN CONNECTION WITH THE SOFTWARE OR THE USE OR OTHER DEALINGS IN THE SOFTWARE.

## PHP 3.01 License

The PHP License, version 3.01 Copyright (c) 1999 - 2010 The PHP Group. All rights reserved.

Component Name	License	URL
php-5.2.17	PHP 3.01	<a href="http://www.php.net/distributions">http://www.php.net/distributions</a>

Redistribution and use in source and binary forms, with or without modification, is permitted provided that the following conditions are met:

1. Redistributions of source code must retain the above copyright notice, this list of conditions and the following disclaimer.
2. Redistributions in binary form must reproduce the above copyright notice, this list of conditions and the following disclaimer in the documentation and/or other materials provided with the distribution.
3. The name "PHP" must not be used to endorse or promote products derived from this software without prior written permission. For written permission, please contact [group@php.net](mailto:group@php.net).
4. Products derived from this software may not be called "PHP", nor may "PHP" appear in their name, without prior written permission from [group@php.net](mailto:group@php.net). You may indicate that your software works in conjunction with PHP by saying "Foo for PHP" instead of calling it "PHP Foo" or "phpfoo".
5. The PHP Group may publish revised and/or new versions of the license from time to time. Each version will be given a distinguishing version number. Once covered code has been published under a particular version of the license, you may always continue to use it under the terms of that version. You may also choose to use such covered code under the terms of any subsequent version of the license published by the PHP Group. No one other than the PHP Group has the right to modify the terms applicable to covered code created under this License.
6. Redistributions of any form whatsoever must retain the following acknowledgment: "This product includes PHP software, freely available from <<http://www.php.net/software/>>".

THIS SOFTWARE IS PROVIDED BY THE PHP DEVELOPMENT TEAM "AS IS" AND ANY EXPRESSED OR IMPLIED WARRANTIES, INCLUDING, BUT NOT LIMITED TO, THE IMPLIED WARRANTIES OF MERCHANTABILITY AND FITNESS FOR A PARTICULAR PURPOSE ARE DISCLAIMED. IN NO EVENT SHALL THE PHP DEVELOPMENT TEAM OR ITS CONTRIBUTORS BE LIABLE FOR ANY DIRECT, INDIRECT, INCIDENTAL, SPECIAL, EXEMPLARY, OR CONSEQUENTIAL DAMAGES (INCLUDING, BUT NOT LIMITED TO, PROCUREMENT OF SUBSTITUTE GOODS OR SERVICES; LOSS OF USE, DATA, OR PROFITS; OR BUSINESS INTERRUPTION) HOWEVER CAUSED AND ON ANY THEORY OF LIABILITY, WHETHER IN CONTRACT, STRICT LIABILITY, OR TORT (INCLUDING NEGLIGENCE OR OTHERWISE) ARISING IN ANY WAY OUT OF THE USE OF THIS SOFTWARE, EVEN IF ADVISED OF THE POSSIBILITY OF SUCH DAMAGE.

This software consists of voluntary contributions made by many individuals on behalf of the PHP Group. The PHP Group can be contacted via Email at [group@php.net](mailto:group@php.net).

For more information on the PHP Group and the PHP project, please see <<http://www.php.net>>. PHP includes the Zend Engine, freely available at <<http://www.zend.com>>.

## zlib / libpng License

This software is provided 'as-is', without any express or implied warranty. In no event will the authors be held liable for any damages arising from the use of this software.

Component Name	License	URL
zlib-1.2.5	zlib / libpng	<a href="http://zlib.net/">http://zlib.net/</a>

Copyright (C) 1995-2010 Jean-loup Gailly and Mark Adler

Permission is granted to anyone to use this software for any purpose, including commercial applications, and to alter it and redistribute it freely, subject to the following restrictions:

1. The origin of this software must not be misrepresented; you must not claim that you wrote the original software. If you use this software in a product, an acknowledgment in the product documentation would be appreciated but is not required.
2. Altered source versions must be plainly marked as such, and must not be misrepresented as being the original software.
3. This notice may not be removed or altered from any source distribution.

Jean-loup Gailly Mark Adler

[jloup@gzip.org](mailto:jloup@gzip.org) [madler@alummi.caltech.edu](mailto:madler@alummi.caltech.edu)

The data format used by the zlib library is described by RFCs (Request for Comments) 1950 to 1952 in the files <http://www.ietf.org/rfc/rfc1950.txt> (zlib format), [rfc1951.txt](http://www.ietf.org/rfc/rfc1951.txt) (deflate format) and [rfc1952.txt](http://www.ietf.org/rfc/rfc1952.txt) (gzip format).



Na wszystkich etapach produkcji firma Hanwha Techwin dba o środowisko naturalne i wykonuje wiele działań dążących do dostarczenia klientom produktów niegroźnych dla środowiska.

Oznaczenie „Eco” świadczy o tym, że firma Hanwha Techwin wytwarza produkty nieszkodliwe dla środowiska oraz wskazuje, że niniejszy produkt spełnia wymagania przedstawione w dyrektywie RoHS obowiązującej w UE.



### Prawidłowe usuwanie produktu (zużyty sprzęt elektryczny i elektroniczny)

To oznaczenie umieszczone na produkcie, akcesoriach lub dokumentacji oznacza, że po zakończeniu eksploatacji nie należy tego produktu ani jego akcesoriów (np. ładowarki, zestawu słuchawkowego, przewodu USB) wyrzucać wraz ze zwykłymi odpadami gospodarstwa domowego. Aby uniknąć szkodliwego wpływu na środowisko naturalne i zdrowie ludzi wskutek niekontrolowanego usuwania odpadów, prosimy o oddzielenie tych przedmiotów od odpadów innego typu oraz o odpowiedzialny recykling i praktykowanie ponownego wykorzystania materiałów.

W celu uzyskania informacji na temat miejsca i sposobu bezpiecznego dla środowiska recyklingu tych przedmiotów, użytkownicy w gospodarstwach domowych powinni skontaktować się z punktem sprzedaży detalicznej, w którym dokonali zakupu produktu, lub z organem władz lokalnych.

Użytkownicy w firmach powinni skontaktować się ze swoim dostawcą i sprawdzić warunki umowy zakupu. Produktu ani jego akcesoriów nie należy usuwać razem z innymi odpadami komercyjnymi.



### Sposób poprawnego usuwania baterii, w które wyposażony jest niniejszy produkt

(Dotyczy obszaru Unii Europejskiej oraz innych krajów europejskich posiadających oddzielne systemy zwrotu zużytych baterii.)

Niniejsze oznaczenie na baterii, instrukcji obsługi lub opakowaniu oznacza, że po upływie okresu użytkowania baterie, w które wyposażony był dany produkt, nie mogą zostać usunięte wraz z innymi odpadami pochodzącymi z gospodarstw domowych. Przy zastosowaniu takiego oznaczenia symbole chemiczne (Hg, Cd lub Pb) wskazują, że dana bateria zawiera rtęć, kadm lub ołów w ilości przewyższającej poziomy odniesienia opisane w dyrektywie WE 2006/66. Jeśli baterie nie zostaną poprawnie zutilizowane, substancje te mogą powodować zagrożenie dla zdrowia ludzkiego lub środowiska naturalnego.

Aby chronić zasoby naturalne i promować ponowne wykorzystanie materiałów, należy oddzielać baterie od innego typu odpadów i poddawać je utylizacji poprzez lokalny, bezpłatny system zwrotu baterii.

