

Thermal Network Hybrid Camera

Web Operation Manual



Foreword

General

This user's manual (hereinafter referred to as "the Manual") introduces the characteristics, basic configurations, daily operation and maintenance of the thermal camera (hereinafter referred to as "the Camera").





Thermal hybrid camera contains all the binocular and trinocular cameras.

Ports

The Manual is mainly about on the web interface, how to operate your Camera. For description of ports such as ports connection and ports debugging, contact technical staffs.

Safety Instructions

The following categorized signal words with defined meaning might appear in the Manual :

Signal Words	Meaning
 DANGER	Indicates a high potential hazard which, if not avoided, will result in death or serious injury.
 WARNING	Indicates a medium or low potential hazard which, if not avoided, could result in slight or moderate injury.
 CAUTION	Indicates a potential risk which, if not avoided, could result in property damage, data loss, lower performance, or unpredictable result.
 TIPS	Provides methods to help you solve a problem or save you time.
 NOTE	Provides additional information as the emphasis and supplement to the text.

Revision History

Version	Revision Content	Release Time
V1.0.0	First release.	January 13, 2017
V1.0.1	"Cybersecurity Recommendations" added.	October 18, 2017
V1.0.2	<ul style="list-style-type: none">Content about Camera initialization added.Interface screenshots updated.Description of reserved spots' input and output added.Content about safety management added.	February 1, 2017
V1.0.3	<ul style="list-style-type: none">Function of safety management modified.Parameters of camera modified.Screenshots of interfaces updated.GDPR requirements added.	July 15, 2018
V1.0.4	Update whole document.	March 2020

Privacy Protection Notice

As the Camera user or data controller, you might collect personal data of others such as face, fingerprints, car plate number, Email address, phone number, GPS and so on. You need to be in compliance with the local privacy protection laws and regulations to protect the legitimate rights and interests of other people by implementing measures include but not limited to: providing clear and visible identification to inform data subject the existence of surveillance area and providing related contact.

About the Manual

- The Manual is for reference only. If there is inconsistency between the Manual and the actual product, the actual product shall prevail.
- We are not liable for any loss caused by the operations that do not comply with the Manual.
- The Manual would be updated according to the latest laws and regulations of related regions. For detailed information, see the paper manual, CD-ROM, QR code or our official website. If there is inconsistency between paper manual and the electronic version, the electronic version shall prevail.
- All the designs and software are subject to change without prior written notice. The product updates might cause some differences between the actual product and the Manual. Please contact the customer service for the latest program and supplementary documentation.
- There still might be deviation in technical data, functions and operations description, or errors in print. If there is any doubt or dispute, please refer to our final explanation.
- Upgrade the reader software or try other mainstream reader software if the Manual (in PDF format) cannot be opened.
- All trademarks, registered trademarks and the company names in the Manual are the properties of their respective owners.
- Please visit our website, contact the supplier or customer service if there is any problem occurred when using the Camera.
- If there is any uncertainty or controversy, please refer to our final explanation.

Table of Contents

Foreword	I
1 Product Introduction	1
1.1 Overview	1
1.2 Features	1
1.3 Functions	2
2 Basic Settings	7
2.1 Initializing Camera	7
2.2 Modifying IP Address	7
2.2.1 Modifying One IP Address	8
2.2.2 Modifying Several IP Addresses	8
2.3 Logging in to Web Interface	10
2.4 Resetting Password	11
3 Daily Operation	13
3.1 Live	13
3.1.1 Introduction to Live Interface	13
3.1.2 Function Bar	14
3.1.3 Window Adjustment	15
3.1.4 More Functions	18
3.2 PTZ	19
3.2.1 Bullet Cameras	19
3.2.2 Speed Dome Cameras & Pan Tilt Cameras	23
3.3 Playback	35
3.3.1 Video Playback	35
3.3.2 Picture Playback	40
3.4 Reports	42
3.5 Alarm	43
3.5.1 Introduction to Alarm Types	43
3.5.2 Subscribing Alarm Information	44
4 Setting	46
4.1 Configuring Camera	46
4.1.1 Configuring Lens	46
4.1.2 Configuring Video Parameters	58
4.1.3 Configuring Audio Parameters	66
4.2 Configuring Network	68
4.2.1 Configuring TCP/IP	68
4.2.2 Configuring Port	70
4.2.3 Configuring PPPoE	73
4.2.4 Configuring DDNS	73
4.2.5 Configuring SMTP	74
4.2.6 Configuring UPnP	76
4.2.7 Configuring SNMP	76
4.2.8 Configuring Bonjour	79
4.2.9 Configuring Multicast	79
4.2.10 Configuring Auto Registration	80

4.2.11 Configuring 802.1X	80
4.2.12 Configuring QoS	81
4.3 Peripheral	82
4.3.1 Configuring IR Light	82
4.3.2 Configuring Wiper	82
4.3.3 Configuring Fan	83
4.3.4 Configuring Heater	83
4.4 Smart Thermal	84
4.4.1 Configuring Smart Plan	84
4.4.2 Configuring Intelligent Video Surveillance (IVS)	84
4.4.3 Call Detection	96
4.4.4 Smoking Detection	98
4.4.5 Boat Detection	100
4.4.6 Configuring Fire Warning	102
4.4.7 Configuring Hot Trace	104
4.4.8 Configuring Pic in Pic	106
4.4.9 Configuring Link Schedule	107
4.4.10 Configure Linked Measures	108
4.5 Event	110
4.5.1 Configuring Video Detection	110
4.5.2 Configuring Audio Detection	114
4.5.3 Configuring Temperature Alarm	117
4.5.4 Configuring Alarm	119
4.5.5 Configuring Abnormality	120
4.6 Temperature Measuring Settings	124
4.6.1 Configuring Rules	124
4.6.2 Configuring Global Setup	128
4.6.3 Exporting Heat Map	130
4.7 Storage Management	131
4.7.1 Configuring Schedule	131
4.7.2 Camera Storage	134
4.7.3 Configuring Record Control Parameters	136
4.8 System Management	137
4.8.1 General Settings	137
4.8.2 User Management	139
4.8.3 Adding ONVIF User	144
4.8.4 Safety Management	145
5 System Maintenance	157
5.1 Maintenance Requirements	157
5.2 Auto Maintenance	157
5.2.1 Rebooting Camera	157
5.2.2 Deleting Old Files	157
5.3 Backing Up and Restoring	158
5.3.1 Importing and Exporting	158
5.3.2 Default Settings	158
5.4 Upgrading Firmware	159
5.5 Version Information	159

5.6 System Log.....	160
5.6.1 Searching System Logs.....	160
5.6.2 Remote View.....	161
5.7 Online User.....	162
6 Additional Accessing Methods	163
6.1 Accessing through NVR.....	163
6.2 Accessing through SmartPSS.....	164
Appendix 1 Cybersecurity Recommendations	165

1 Product Introduction

1.1 Overview

Thermal Hybrid Camera is based on requirements such as temperature monitoring, fire prevention, safety protection and night vision. This product can help you view videos, videotape an object, test temperature, warn the potential fire, track a cold/hot spot and analyze a special behavior. This product can be used in energy industry, transportation, building, power system, public security, government, enterprises, and other fields (such as science, education, culture and health). You can use the product alone or combine the product with other storage Cameras to provide solutions for safety/intelligence city, production safety, safety protection of residential buildings and public area safety.

1.2 Features

- Safe and stable.
With a full embedded system, this Camera can implement all-day monitoring in a stable way.
- A long detection distance.
Wide monitoring range and long detection distance. Used for surveillance of wide range and long distance.
- Strong detection ability.
With night vision ability, this Camera can clearly distinguish different objects in the dark and can tell camouflage and hidden objects.
- Strong anti-interference ability.
This Camera can get rid of interference of light intensity under backlight or strong light environment.
- Adaptive capacity to complex environment.
Applicable to such environment as smoke, smog, rain, snow, and dust which will block your eyes and is very confusing in colors.

This product can be used in various scenarios and the "small application scenarios" is taken as an example here for detailed description. See Figure 1-1.

Figure 1-1 Application scenarios

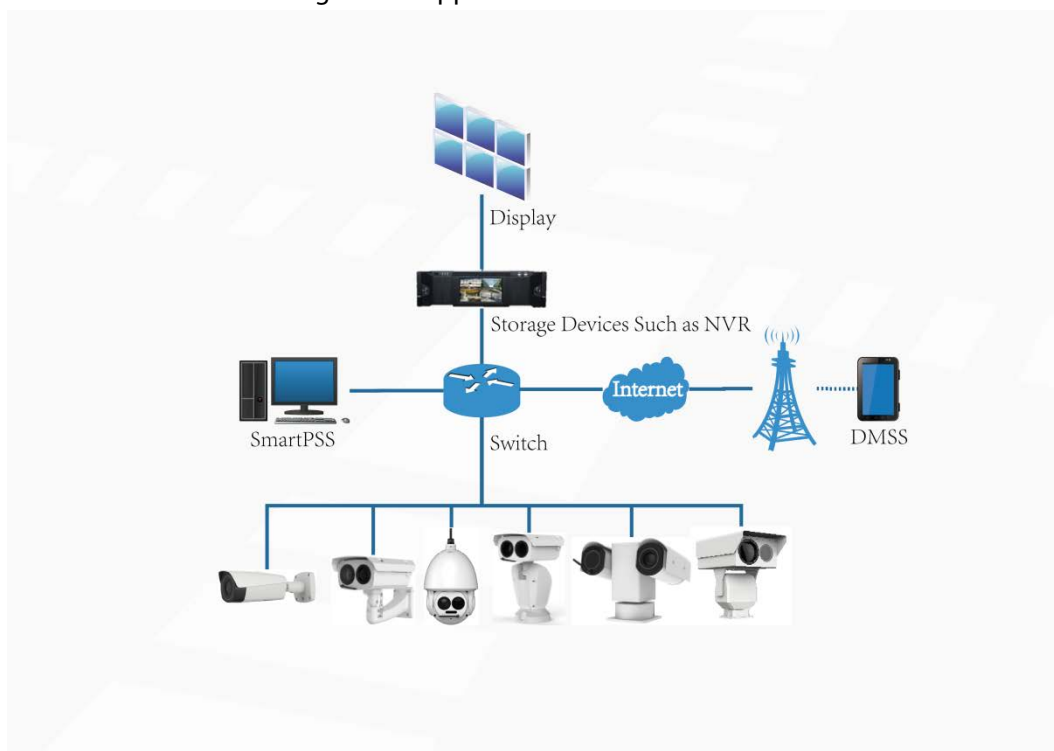

1.3 Functions

Live

Table 1-1 Function description

Function	Description
Live	You can view both the visible images and thermal images. You can use thermal images to identify an object, and then use visible images to view more details of the object.
PTZ operation	For those cameras with PTZ, you can use the PTZ to operate the cameras to enlarge the surveillance range and identify details of an object. <ul style="list-style-type: none"> For bullet cameras, you can set a bullet camera's PTZ functions such as preset, tour and pattern. You can set a speed dome camera's PTZ functions or a pan & tilt camera's PTZ functions such as preset, tour, pattern, horizontal rotation, PTZ speed, free action, boot action and timing task.
Voice intercom	For cameras with voice intercom function, you can talk indoors with a person near the outdoor monitor to facilitate problem solution.
Snapshot	When previewing, you can snapshot an abnormal image for further check and handling.
Local recording	When previewing, you can record abnormal images for further check and handling.
Real-time reports	For cameras with temperature measuring, you can check the real-time temperature data of your monitoring area.

Real-time spot temperature monitoring	For cameras with temperature measuring, you can check the real-time temperature data of any spot in your monitoring area.
Laser ranging	For cameras with laser ranging, you can measure the distance between the camera and the object in the middle of the image.
Additional functions	<ul style="list-style-type: none"> ● Switch video bit stream or streaming protocol. ● The visible image will be adjusted to the relevant location when you zoom in or out the thermal image. ● Mark information you need in the surveillance image. ● Check whether there is any alarm output. ● Magnify part of the surveillance image. Or, scroll the mouse to zoom the whole surveillance image. ● You can help the camera focus manually on the web interface. ● Set a smart rule. When the rule is broken and an alarm is triggered, you can track the target manually. ● Adjust display effect of the surveillance images. ● Boot up or shut down the intelligent rule display.

Playback

Table 1-2 Description of playback function

Function	Description
Videotaping manually	When playing back a video, you can record the key information of the previous video for further check and handling.
Planned recording	After you set a recording plan, the system will record automatically.
Video playback and download	<ul style="list-style-type: none"> ● Play back a previous video to find some valuable video fragments. ● Download the valuable video fragments for further judgment.
Picture playback	Play back pictures you have snapshot to find something valuable.
Relay activation	When there is an alarm, the system will videotape automatically.

Report

You need to follow certain rules such as time sequence to check history data of temperature saved in the Camera Micro SD card.

Alarm

- Set prompting mode (sound, for example) based on the alarm type.
- View alarm information.

Account Management

Table 1-3 Function description

Function	Description
Management of user group	<ul style="list-style-type: none"> ● Add, modify or delete an account group. ● Manage user permissions based on user groups.

User Management	<ul style="list-style-type: none"> • Add, modify or delete a user account. • Set the user permissions.
Change password	Change users' admin password.

External Camera Management

You can manage your camera's external Cameras such as heater, fill light and wiper.

Smart Thermal

Table 1-4 Function description

Function	Description
Intelligent Video Surveillance	<ul style="list-style-type: none"> • Both visible channel and thermal channel have intelligent rules. • When there is an alarm, you can implement following operations at the same time such as linkage video recording, alarm output, email delivery, PTZ operation and screenshots. • Supports addition of detection area and exclusion area. • You can set the tracking mode in the linked tracking function.
Calling Behavior Detection	<ul style="list-style-type: none"> • Available in visible channel. • When the Camera detects calling behavior, linked measures will be triggered such as Audio Linkage, White Light, Send Email and Record.
Smoking Detection	<ul style="list-style-type: none"> • Available in visible channel. • When the Camera detects smoking behavior, linked measures will be triggered such as Audio Linkage, White Light, Send Email and Record.
Boat Detection	<ul style="list-style-type: none"> • Available in thermal channel. • When the Camera detects unexpected boat, linked measures will be triggered such as Relay-out, Send Email and Record.
Fire Warning	<ul style="list-style-type: none"> • Available in thermal channel. • When there is an alarm, you can implement following operations at the same time such as linkage video recording, alarm output, email delivery, PTZ operation and screenshots.
Cold/hot spot tracking	<ul style="list-style-type: none"> • Only thermal channel can implement the cold/hot spot tracking operation. • Supports real-time display of surveillance scenario's cold spots and hot spots according to different colors. • When there is an alarm, you can implement following operations at the same time such as linkage video recording, alarm output, email delivery, PTZ operation and screenshots.
Picture in picture	<ul style="list-style-type: none"> • Only visible channel can implement the picture in picture operation. • You can put the thermal image into the visible image.

Event

Table 1-5 Function description

Function	Description
Video detection	<ul style="list-style-type: none"> You can implement operation of motion detection and video masking detection. When there is an alarm, you can implement following operations at the same time such as linkage video recording, alarm output, email delivery, PTZ operation and screenshots.
Audio detection	<ul style="list-style-type: none"> Supports detection of input exception and mutation of acoustic intensity. When there is an alarm, you can implement following operations at the same time such as linkage video recording, alarm output, email delivery, PTZ operation and screenshots.
Temperature alarm	<ul style="list-style-type: none"> When temperature satisfies the alarm conditions of temperature testing rules, an alarm is triggered. When there is an alarm, you can implement following operations at the same time such as linkage video recording, alarm output, email delivery, PTZ operation and screenshots.
Alarm settings	<ul style="list-style-type: none"> The alarm is triggered when there is an alarm from external Camera. When there is an alarm, you can implement following operations at the same time such as linkage video recording, alarm output, email delivery, PTZ operation and screenshots.
Abnormality	<ul style="list-style-type: none"> Supports detection of SD card or network abnormality and illegal access. When there is SD card abnormality or illegal access, you can implement following operations at the same time such as linkage video alarm output, and email delivery. When there is an alarm of network abnormality, you can implement following operations at the same time such as linkage video recording, and alarm output.

Temperature Measuring Settings

This function is available on select model.

Table 1-6 Function description

Function	Description
Temperature measuring rules	<ul style="list-style-type: none"> Supports measuring spot, line, polygon and ellipse's average temperature, maximum temperature and minimum temperature. Supports outputting alarm based on different conditions. Supports setting different alarm output conditions to different objects that need to be measured.
Temperature contrast	<ul style="list-style-type: none"> Supports temperature contrast of different objects that needs to be measured. Supports outputting alarm based on different conditions. Supports setting different alarm output conditions to different temperature contrast rules.

Heat map	Supports outputting real-time heat map information. Then, you can do the further analysis through the heat map tools.
Additional functions	<ul style="list-style-type: none">• Supports enabling or closing temperature testing rules.• Supports enabling or closing isotherm.• Supports enabling or closing color code articles.

2 Basic Settings

2.1 Initializing Camera

Initialize your Camera and set the user password when you are logging in for the first time or after you have restored your camera to default settings. Initialize the Camera by ConfigTool or through web. This section takes web for example.



- Ensure your Camera IP address (192.168.1.108 by default) and your PC IP address are in the same network segment.
- To secure the Camera data, keep admin password well after initialization and modify it regularly.

Step 1 Open a browser, enter Camera default IP address in the address bar, and then press **Enter**. The **Device Initialization** interface is displayed. See Figure 2-1.

Figure 2-1 Initializing camera

The screenshot shows a web form titled "Device Initialization". It contains the following elements:

- Username:** A text input field with "admin" entered.
- Password:** A text input field with a strength indicator below it showing "Weak", "Middle", and "Strong" buttons.
- Confirm Password:** A text input field.
- Email Address:** A text input field with a checked checkbox to its left.
- Instructions:** A paragraph of text: "Use a password that has 8 to 32 characters, it can be a combination of letter(s), number(s) and symbol(s) with at least two kinds of them. (please do not use special symbols like ' " ; : &)".
- Reset Note:** A note below the email field: "To reset password, please input properly or update in time."
- Save Button:** A button labeled "Save" at the bottom center.

Step 2 Set the login password for admin account. See Table 2-1.

Table 2-1 Password setting description

Parameter	Description
Password	Enter your password and enter it again to confirm it. 
Confirm Password	It is recommended to use strong password. The password must consist of 8 to 32 non-blank characters and contain at least two types of characters among upper case, lower case, number, and special character (excluding ' " ; : &).
Email Address	Enter an email address to reset password when you forget it.

Step 3 Click **Save**.

2.2 Modifying IP Address

Modify Camera IP address and ensure it is fitted to the actual network segment to get the Camera access network.

You can modify one or several IP addresses through ConfigTool. You can also log in the web client to modify IP addresses.

2.2.1 Modifying One IP Address

When there are only a few Cameras or the login passwords of Cameras are different, you can modify only one IP address at one time. Logging in web client to modify IP addresses is taken as an example for detailed description.

Step 1 Log in Camera web interface.

Step 2 Select **Setup > Network > TCP/IP**.

The **TCP/IP** interface is displayed. See Figure 2-2.

Figure 2-2 TCP/IP

Step 3 Configure TCP/IP parameters. See Table 2-2.

Table 2-2 TCP/IP parameters

Parameter	Description
Host Name	Give your Camera a name (TPCDome, for example) to help others, (a router operator, for example), know the Camera information such as shape information—dome thermal camera.
IP Address, Subnet Mask and Default Gateway	Fill in the three item values according to the actual network segment.
Ethernet Card, Mode, MAC Address, IP Version, Preferred DNS and Alternate DNS	Leave them to the default values.

Step 4 Click **Save**.

2.2.2 Modifying Several IP Addresses

When there are several Cameras or the login passwords of Cameras are the same, you can modify several IP address at the same time through the ConfigTool.

Preparation

- You have obtained the installation package of ConfigTool. To obtain the installation package, you can consult technical support staffs.
- You have achieved network communication between PC (which is with ConfigTool) and the Camera.

Procedure

Step 1 Click .

The **Modify IP** interface is displayed.

Step 2 Click **Search Settings**.

The dialog box named by "settings" is displayed.

Step 3 Set the network segment of the Camera, admin and password. Then click **Save**.

After the search, the system displays Cameras that have been searched.



Default user name and password are both admin.

Step 4 Select Cameras whose IP address needs to be modified and click the icon indicating that you can modify several IP addresses at one time.

The dialog box of **Modify IP Address** is displayed. See Figure 2-3.

Figure 2-3 Modifying IP address



Step 5 Select the mode of IP address based on the actuality.

- DHCP mode: When there is a DHCP server in the network, set the **Mode** as **DHCP** and the Camera obtains IP addresses from the DHCP server automatically.
- Manual mode: Set **Mode** as **Static** and enter **Starting IP**, **Subnet Mask** and **Gateway**. Then, IP addresses of Cameras are incrementally modified from the start IP address.



Select the check box of **The Same IP** and set the IP addresses of the Cameras you have picked up as the same one.

Step 6 Click **Save**.

2.3 Logging in to Web Interface

After you have modified the IP addresses, you can log in the WEB interface of the Camera through a browser to operate, configure and maintain the Camera.

Background Information

To log in the Camera in a smooth way, you need to make sure that the PC connected to the Camera satisfies the following requirements. See Table 2-3.

Table 2-3 Recommended PC configuration

PC items	Recommended configuration
Operation system	≥ Windows 7
CPU	≥ Intel core i3
Graphics card	≥ Intel HD Graphics
Storage	≥ 2GB
Display	≥ 1024×768 Resolution
Browser	Internet Explorer 9/10/11

Procedure

Step 1 Open browser, enter IP address in the address bar, and then press **Enter**. The **login** interface is displayed. See Figure 2-4.

Figure 2-4 Login

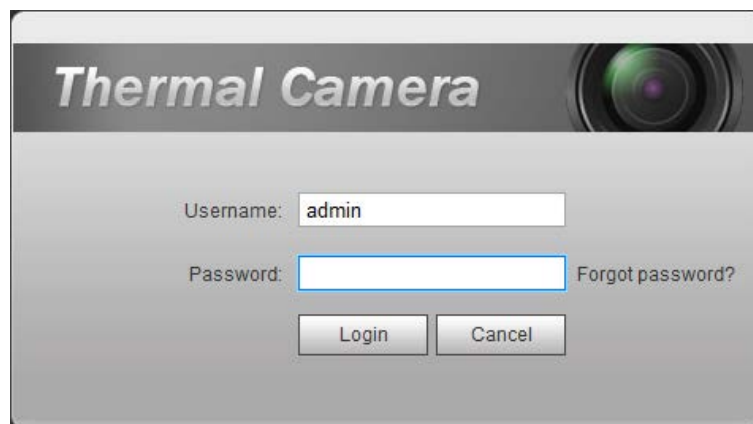

Step 2 Enter username and password, and click **Login**.

After the successful login, the **Live** interface is displayed. See Figure 2-5.



- The default user is admin. The password is the one that was configured during initial settings.
- It will prompt you to install plug-in for the first system login. Please download and install plug-in according to the prompt.
- Functions of different Cameras might vary, and the actual product shall prevail.

Figure 2-5 Live Interface

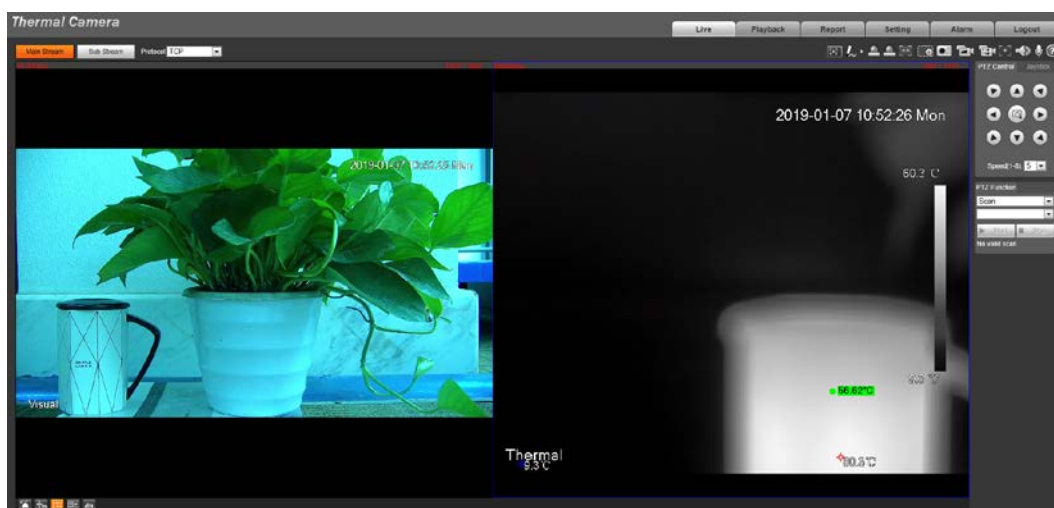

Click **Log out** on the upper right corner to exit the interface.

2.4 Resetting Password

If you forget the password, you can use the reserved e-mail address to achieve password resetting.

Step 1 Open IE browser and type the camera's IP address. Then press Enter.

The **Thermal Camera** interface is displayed. See Figure 2-6.

Figure 2-6 Logging in the Camera

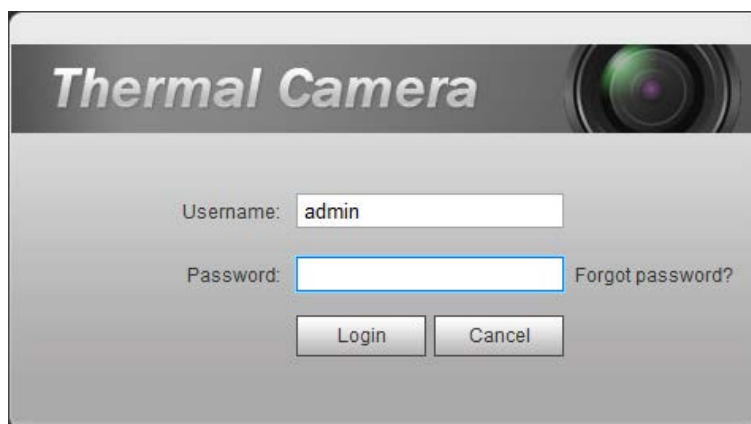

Step 2 Click **Forgot Password?**

The **Reset the password (1/2)** interface is displayed. See Figure 2-7.

Figure 2-7 Reset the password(1/2)

Reset the password(1/2)

SN: 2C04AB9YAZ00019

QR code:

Please scan the QR code on the actual interface

Note(For admin only):
Option 1. Please download Easy4ip and then from Me-Settings-Reset device password, scan the left QR code.
Option 2. Please use an APP to scan the left QR code to get special strings. And then send the strings to support_rpwd@global.dahuatech.com.

The security code will be delivered to 1***@qq.com

Security code:

Cancel Next

Step 3 Reset the password.

Scan the QR code, and the security code will be sent to the email address you have already fulfilled. Type the security code then.



- Reset the password in time when you receive the security code, because the security code will be invalid within 24 hours.
- If you get security codes twice but do not use them, when you get the security code for the third time, the system will prompt failure. To solve this problem, you need to restore your Camera to default settings or wait 24 hours to get a new one.

Step 4 Click **Next**.

The **Reset the password (2/2)** interface is displayed. See Figure 2-8.

Figure 2-8 Resetting the password(2/2)

Reset the password(2/2)

Username admin

Password

Weak Middle Strong

Use a password that has 8 to 32 characters, it can be a combination of letter(s), number(s) and symbol(s) with at least two kinds of them. (please do not use special symbols like """, ":", "&")

Confirm Password

Cancel Save

Step 5 Fill in a new password and confirm it.

The password is made up of characters for 8–32 digits and the password must contain two of the three forms (number, letter, and the common characters. ""、""、"、“:”、“&”are not included.) You should obey the prompt of the password’s security level and set a password with high security level.

Step 6 Click **Save**.

The login interface is displayed.

3 Daily Operation

3.1 Live



Cameras of different models might have different functions. The web operation manual is for thermal hybrid cameras of all models. So your final interface shall prevail.

On the Live interface, you can do operations to the real-time surveillance images such as viewing, taking snapshots and recording videos.



- Image channel with a box around it is the one that has been chosen. All your operation is valid only to this channel.
- Double-click an image channel and the image channel is displayed in a full video display area. Double-click the image channel again and the channel will be displayed in a full screen. Then, right-click the full-screen image and the image returns to its previous state.

3.1.1 Introduction to Live Interface

Click the **Live** tab, and the **Live** interface is displayed. See Figure 3-1. In the live interface, there are five function bars. See Table 3-1.

Figure 3-1 The live interface

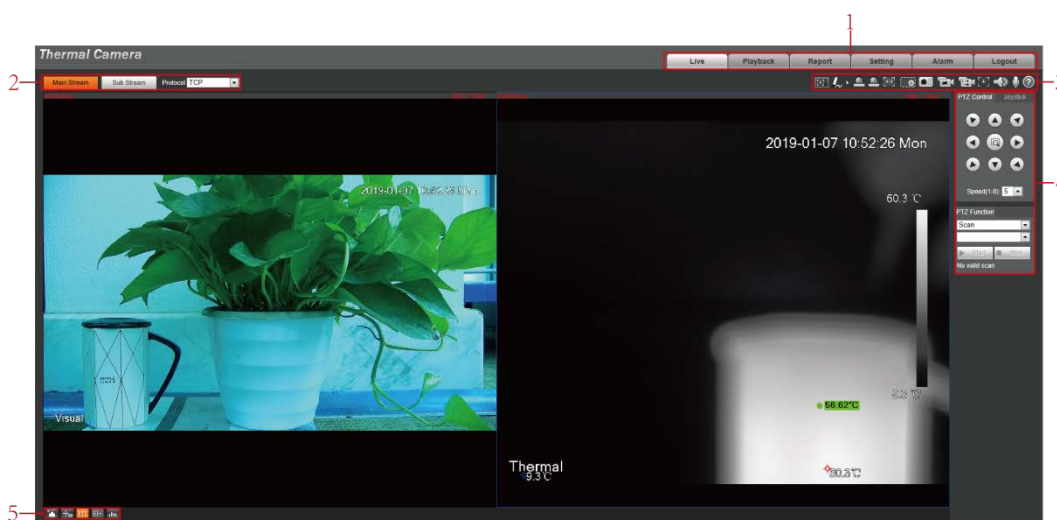

Table 3-1 Description of function bar

No.	Name	Description
1	System menu	Click each function tab in the system menu to go to the corresponding interface.

2	Encode bar	<p>Select bit stream type and streaming protocol when previewing a video.</p> <ul style="list-style-type: none"> ● Main Stream: It has large bit stream value and image with high resolution, but also requires large bandwidth. This option is normally used for storage and surveillance. ● Sub Stream: It has small bit stream value and smooth image, and requires little bandwidth. This option is normally used to replace main stream when bandwidth is not enough. ● Streaming protocol: A network transmission protocol, supports TCP, UDP and Multicast.
3	Live view function bar	For functions and operations of live view bar, see "3.1.2 Function Bar."
4	PTZ control	For details of PTZ control, see "3.2 PTZ."
5	Adjustment bar of video window	Supports adjusting clarity of video images, displaying intelligent rules, zooming with focusing at the same time, checking real-time reports. See "3.1.3 Window Adjustment".











3.1.2 Function Bar

Figure 3-2 Live view function



Table 3-2 Live view function description

Icon	Name	Description
	Regional focus	Click this icon, and click or draw a box on the video image. Then the camera will implement auto focus.
	Mark pen	<p>Click to mark a target on the video image and the default pen color is red.</p> <p>Click to switch the pen color from red, green and blue.</p> <p></p> <p>Marks are not carried in video recordings.</p>
	Relay-out	<p>Shows alarm output state. Click the icon to force enable or force disable alarm output.</p> <p>Alarm output state description:</p> <ul style="list-style-type: none"> ● Red: Alarm output. ● Grey: Alarm over.
	Fixed Focus	Click this icon. Then the visible image adjusts its values of zoom and focus in accordance with values of the thermal image.
	Zoom in	<p>You can zoom in video image with two operations:</p> <ul style="list-style-type: none"> ● Click the icon to enlarge part of visible light or thermal images. Right-click to resume. ● Click the icon to zoom a video image by scrolling the mouse.

	Snapshot	Click the icon to capture a live image and save it under the path you have set.  To check or modify the storage path, see "4.7.2.1 Configuring Storage Path."
	Single-channel video recording	Select visible image or thermal image. Then click this icon to start video recording.  To check or modify the storage path, see "4.7.2.1 Configuring Storage Path."
	Double-channel video recording	If you want to record both visible image and thermal image at the same time, click this icon. And, when you play the videos, videos of both visible image and thermal image will be played.
	Easy Focus	 Only thermal image supports easy focus. Click this icon. Then you can see the two parameters of AF Peak and AF Max. <ul style="list-style-type: none"> • AF Peak: The live image clarity value. • AF Max: The best image clarity value. The closer AF Peak is to AF Max, the better the focusing effect. Easy focus will be disabled after five minutes.
	Object Tracking	Refer to "4.4.2 Configuring Intelligent Video Surveillance (IVS)" to configure smart rules. Then click the icon and draw a box where the object you are interested in is located. Then the box will follow the object to help you track the object. For example, in a square crowded with people, decide a people you are interested in and draw a box around the people. Then the box will help you identify or track the people when he/she is going through or trying to hide in the crowd.
	Audio	Click the icon to enable or disable audio output.
	Voice Talk	Click this icon to enable or disable the intercom function. Open stereo remix after enable the voice intercom function.
	Help	Click to open help document.

3.1.3 Window Adjustment

Figure 3-3 Window adjustment (speed dome cameras and pan & tilt cameras)



Figure 3-4 Window adjustment (bullet cameras)



3.1.3.1 Image Adjustment

Adjust brightness, contrast, hue and saturation of video images on your web.



For detailed operations, see "4.1.1 Configuring Lens."

Click , and the **Image Adjustment** interface is displayed at the right side of live interface. See Figure 3-5.

Figure 3-5 Image adjustment interface

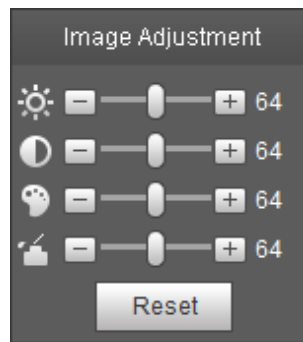



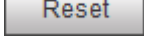



Table 3-3 Image adjustment configuration

Icon	Function	Description
	Brightness	Adjusts the overall image brightness, change the value when the image is too bright or too dark. The bright and dark areas will have equal changes.
	Contrast	Change the value when the image brightness is proper but contrast is not enough.
	Hue	Makes the color deeper or lighter. The default value is made by the light sensor and is recommended.
	Saturation	Adjusts color depth. This value doesn't change the overall image brightness.
	Reset	Click the icon to reset brightness, contrast, hue and saturation to their default values.

3.1.3.2 Display of Smart Rules

You can control whether rules information is displayed on surveillance images. It is set by default that this function is in opening state.

Click  to select **Enable**, and then select **Enable** to display smart rules and detection box; select **Disable** to stop.

3.1.3.3 Zoom and Focus





Zooming and focusing functions are only available on motorized vari-focal Cameras.

Adjust focal length of your lens to zoom in or out surveillance images; adjust optical afterfocus of your lens to improve clarity level of video images.

Click , and the zooming and focusing interface is displayed at the right side of live interface.

- Select the visible channel and you can zoom, focus and change the aperture.
- Select the thermal channel and you can zoom and focus.

Table 3-4 Zoom and focus description

Parameters	Description
Variable focal length	Click  or  , and adjust the optical back focal length of thermal tunnel to make images more clear.
Auto focus	Auto focus.

3.1.3.4 Optical Axis Calibration

Used only for calibrating the Camera lens when the Camera is being debugged in the factory. You do not need to operate this function.

3.1.3.5 Real-time Reports

Within the set time, record the average temperature of the presets, lines and area that you have selected.



Only Cameras with temperature-measuring function support this function, and the actual product shall prevail.

Preparation

You have set the temperature measuring rules. For detailed operation, see "4.6.1.1 Configuring Temperature Measuring Rules."

Procedure

Click  and the real-time reports interface is displayed. Select the temperature-measuring program and set the time circle. Then the real-time temperature change is displayed. See Figure 3-6.

Figure 3-6 Temperature recording area



3.1.4 More Functions

3.1.4.1 Real-time Spot Temperature Measuring



Only Cameras with temperature-measuring function support this function, and the actual product shall prevail.

Move the pointer to any position of the video image and click. Then the real-time temperature of this spot is displayed. See Figure 3-7.

Figure 3-7 Real-time spot temperature measuring

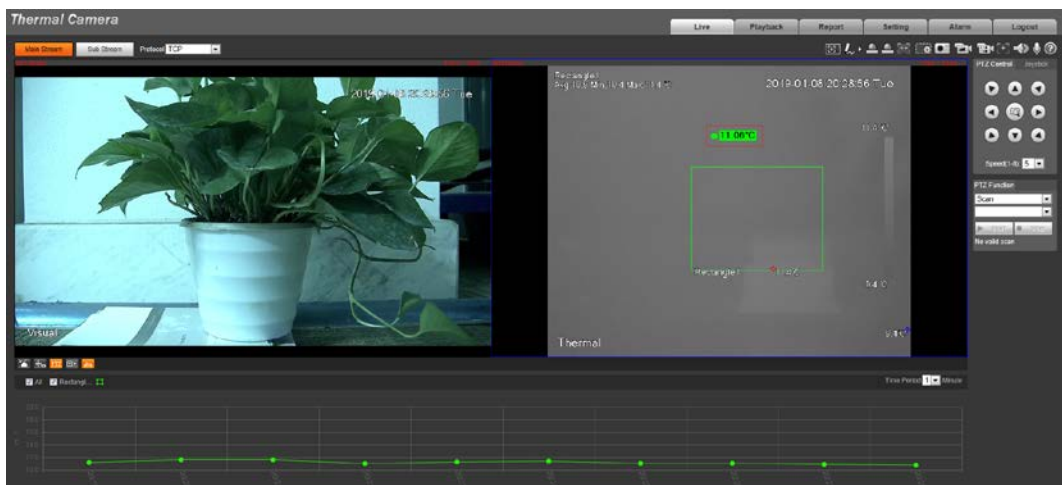

3.1.4.2 Laser Ranging



- Only Camera with laser ranging can implement this operation and the actual interface shall prevail.
- Laser ranging does not perform well to those objects (such as glass and marble) with strong reflection ability. During laser ranging, select those objects with rough surface as your target.



Mind the distance during laser ranging. Less than 50 m will result in a damaged laser.

Click Start Ranging, and the camera starts to measure the distance from itself to the object in the middle of the image (as indicated with the red cross sign).

3.2 PTZ

3.2.1 Bullet Cameras



PTZ setting of bullet camera is used for controlling external PTZ Camera. Connect the Camera to external PTZ through RS-485 port before using this function.

3.2.1.1 Configuring Protocol

If you want to control the external PTZ by your bullet camera, you need to set the PTZ protocol first and then connect PTZ to your camera.

Step 1 Select **Setting > System Management > PTZ Setting**.

The **PTZ Settings** interface is displayed. See Figure 3-8.

Figure 3-8 PTZ settings

Step 2 Configure PTZ parameters. See Table 3-5.

Table 3-5 Parameter description

Parameter	Description
Protocol	Matches with the PTZ protocol.
Address	Enter the corresponding Camera address.  The entered address must be the same with the address configured on the PTZ; otherwise the PTZ cannot be controlled from the bullet camera.
Baud rate	Configure Camera baud rate.
Data bit	The default is "8".
Stop bit	The default is "1".
Parity	The default is "none".

Step 3 Click **Save**.

3.2.1.2 Configuring PTZ Functions



- The protocol setting has been completed. For detailed operations about protocol setting, see "3.2.1.1 Configuring Protocol".
- For images representing the effect of external PTZ, you need to preview on the preview images of the external PTZ, not on the preview image of the bullet camera.
- The following functions are available only when your bullet camera is connected to the external PTZ.

3.2.1.2.1 Configuring Scan

The camera scans on the horizontal direction between the left and right borders.

Step 1 Click the **PTZ** tab and select **Scan** in the PTZ function setting list.

Figure 3-9 Linear sweep

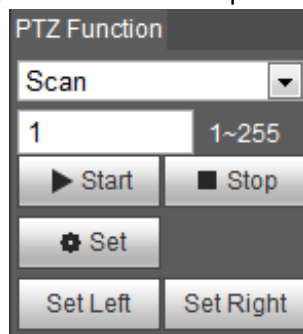

Step 2 Type the scan number and set the left and right border.

- 1) Through the direction button, move the camera to the left border that you want and click **Set Left**.
- 2) Through the direction button, move the camera to the right border that you want and click **Set Right**.

Step 3 Click **Start** to start scan; click **Stop** to end it.

3.2.1.2.2 Configuring Presets

By configuring presets, the camera can store parameters such as PTZ's horizontal angle, inclination angle, and the lens focal length under the current situation to the Camera. If you need those parameters later, you can quickly adopt them and adjust the PTZ and camera to those locations.

Step 1 Click the **PTZ** tab and select **Preset** in the **PTZ Function** setting list.

Figure 3-10 Preset

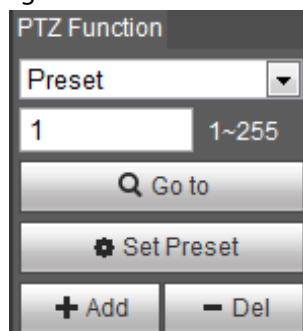

Step 2 Through the direction button, move the camera to the surveillance direction that you need.

Step 3 In the preset box, type the preset number.



Range of the preset number is limited by the PTZ protocol.

Step 4 Click **Add** to add a preset.

Step 5 Enter a preset number and click **Go to**. The camera turns to the corresponding position.

3.2.1.2.3 Configuring Tour

By configuring tour, you can put the presets to the auto tour to make the camera move back and forward quickly and automatically according to the presets.

Preparation

You have set several presets.

Procedure

Step 1 Click the **PTZ** tab and select **Tour** in the **PTZ Function** setting list.

Step 2 In the tour typing box, type the tour number.



Range of the preset number is limited by the PTZ protocol.

Step 3 In the preset typing box, type the preset number.

Step 4 Click **Add Preset** to add a preset in the tour.

Repeat step 3 to step 4 to add several presets in the tour.



Type a preset number and click **Delete Preset** to delete preset it in the tour group.

Step 5 Type a tour number. Click **Start** to start touring; click **Stop** to end it.

3.2.1.2.4 Configuring Pattern

By configuring pattern, you can record continuously your operation to the PTZ and record the moving pattern of the camera's lens. The Camera will make the location where the recording begins as the beginning point, and move back and forward automatically following the preset movement pattern.

Step 1 Click the **PTZ** tab and select **Pattern** in the **PTZ Function** setting list.

In the pattern typing box, type a pattern number.



Range of the pattern number is limited by the PTZ protocol.

Step 2 Click **Start Rec**.

Step 3 By operating the PTZ control panel, you can control the camera's surveillance direction, zoom images or change the focal length.

Step 4 Click **Stop Rec** to complete setting of the pattern.

Step 5 Select a pattern number. Click **Start** to start pattern; click **Stop** to end it.

3.2.1.2.5 Turing on Wiper

Step 1 Click the **PTZ** tab and select **Wiper** in the **PTZ Function** setting list. See Figure 3-11.

Figure 3-11 Wiper

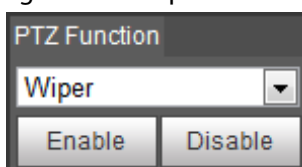

Step 2 Click **Enable** to enable the wiper; click **Disable** to disable it.

3.2.1.3 Operating PTZ



- The corresponding protocol setting and function setting have been completed. See "3.2.1.1 Configuring Protocol" and "3.2.1.2 Configuring PTZ Functions" for more details.
- For images representing the effect of external PTZ, you need to preview on the preview images of the external PTZ, not on the preview image of the bullet camera.

Click the **PTZ** tab and the PTZ control panel is displayed on the right side of the PTZ interface. See Figure 3-12.

Figure 3-12 PTZ control panel

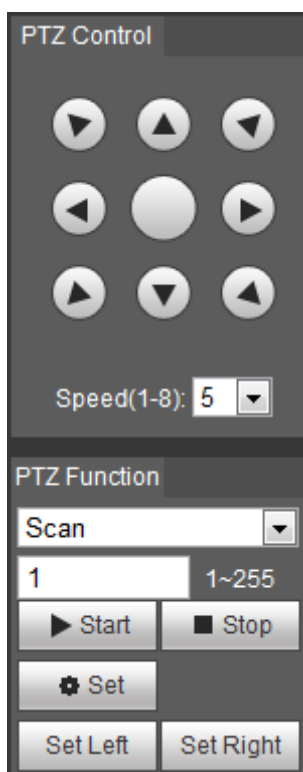

Table 3-6 Parameter description

No.	Function	Description
1	Direction button	Eight directions are contained: up, down, left, right, upper left, upper right, lower left, and lower right.
2	Speed	Controls the movement speed. The bigger the value is, the faster the movement will be. With this function, you can also change the speed of adjusting the PTZ direction, zooming, changing the focal length and adjusting the aperture.

3	PTZ function	For detailed operations of PTZ, see "3.2.1.2 Configuring PTZ Functions."
---	--------------	--

3.2.1.4 Configuring Preset Backup

You can export presets you have set to back them up. When you need those presets, you can import them to your Camera and restore them.



If you want to export or import presets, you have to obey the following steps.

Step 1 Select **Setting > PTZ > Preset Backup**.

The **Preset Backup** interface is displayed.

Figure 3-13 Preset backup

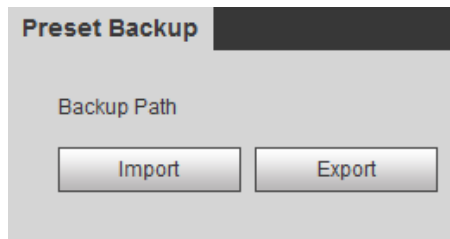

Step 2 Export or import presets.

- Click **Export** to export presets for backup.
- Click **Import** to import presets you have already backed up

3.2.2 Speed Dome Cameras & Pan Tilt Cameras

3.2.2.1 Configuring Protocol

For external Cameras (such as network keyboard, NVR), if you want to use them to control the dome camera or its PTZ, you need to set the protocol to connect the external Cameras to the dome camera or its PTZ first.

Step 1 Select **Setting > PTZ > Protocol**.

The **Network PTZ** interface is displayed. See Figure 3-14.

Figure 3-14 Network PTZ setting

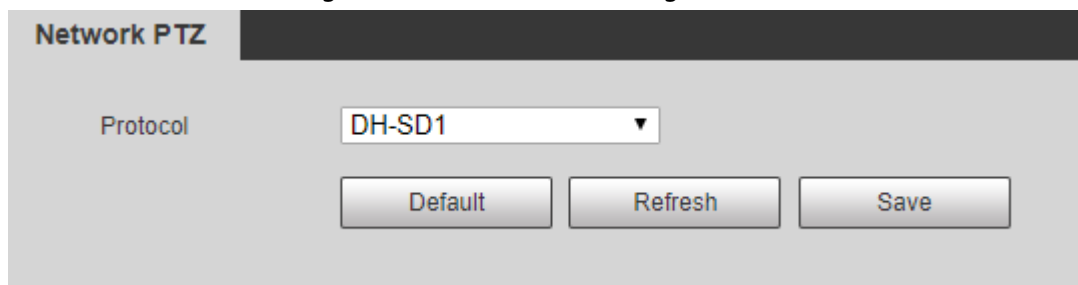



Step 2 Select the protocol that is matched with the camera.

Step 3 Click **Save**.

3.2.2.2 Configuring PTZ Functions

Select **Setting > PTZ > Function** and the **Function** interface is displayed.

It's set by default that the thermal image is displayed. In the thermal image, you can click  to switch the image to visible image. And, in the visible image, you can click  to switch the image to thermal image.

3.2.2.2.1 Configuring Preset

By configuring presets, the camera can store parameters such as PTZ's horizontal angle, inclination angle, and the lens focal length under the current situation to the Camera. If you need those parameters later, you can quickly adopt them and adjust the PTZ and camera to those locations.

Step 1 Select **Setting > PTZ > Function**.

The **Preset** interface is displayed. See Figure 3-15.

Figure 3-15 The preset interface

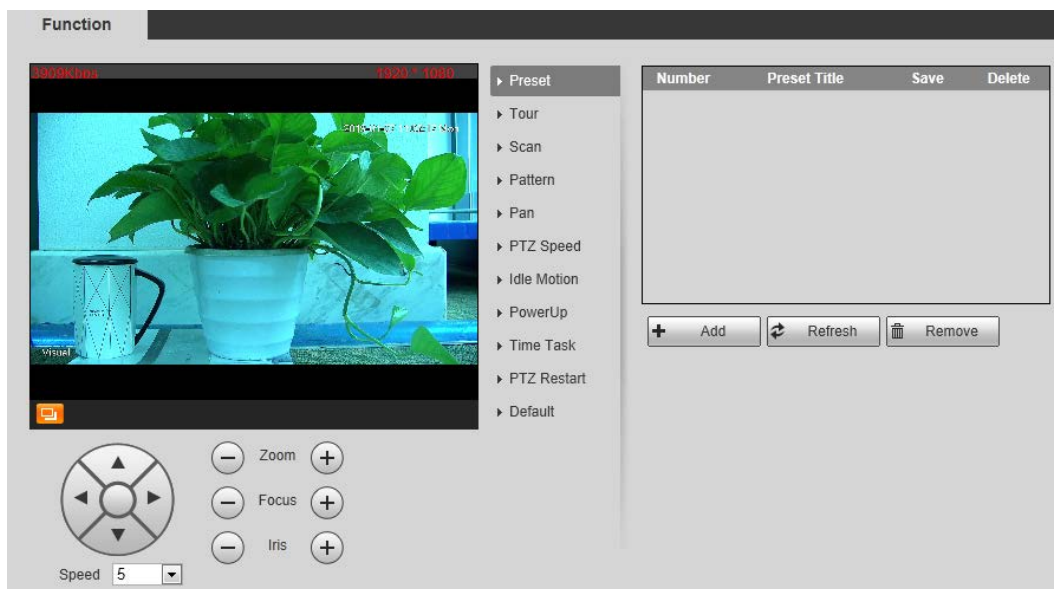

Step 2 Configure preset.

- 1) Click **Add** to add a new preset.
- 2) Operate the PTZ control panel to move the camera lens to a specific direction you need.
- 3) Double-click the preset's **Number** to modify it.
- 4) Double-click the preset's **Preset Title** to modify it. Then click .



- Click  to delete a preset that is wrongly configured or that is not needed anymore.
- Click **Delete** to delete all the presets you have added.

3.2.2.2 Configuring Tour

By configuring tour, you can put the presets to the auto tour group to make the camera move back and forward quickly and automatically according to the presets.

Preparation

You have set several presets.

Procedure

Step 1 Select **Setting > PTZ > Function > Tour**.

The **Tour** interface is displayed. See Figure 3-16.

Figure 3-16 The tour interface



Step 2 Configure tour.

- 1) Click **Add** to add a tour.
- 2) Click **Add** to add a preset.
Click repeatedly to add several presets.
- 3) Double-click to select a preset. And double-click to configure the lasting time.
- 4) Double-click the touring name that you have added to modify it. Click **Save**.



Click  to delete a tour or a preset.

Step 3 Select a tour and click **Start** to start camera tour.

Click **Stop** to stop the tour.

3.2.2.3 Configuring Scan

You can configure an arc and horizontal area for your camera PTZ's rotation. Then by giving your PTZ a fixed rotation speed, you can get your camera scan from left to right (and from right to left) at a fixed speed.

Step 1 Select **Setting > PTZ > Function > Scan**.

The **Scan** interface is displayed. See Figure 3-17.

Figure 3-17 The scan interface

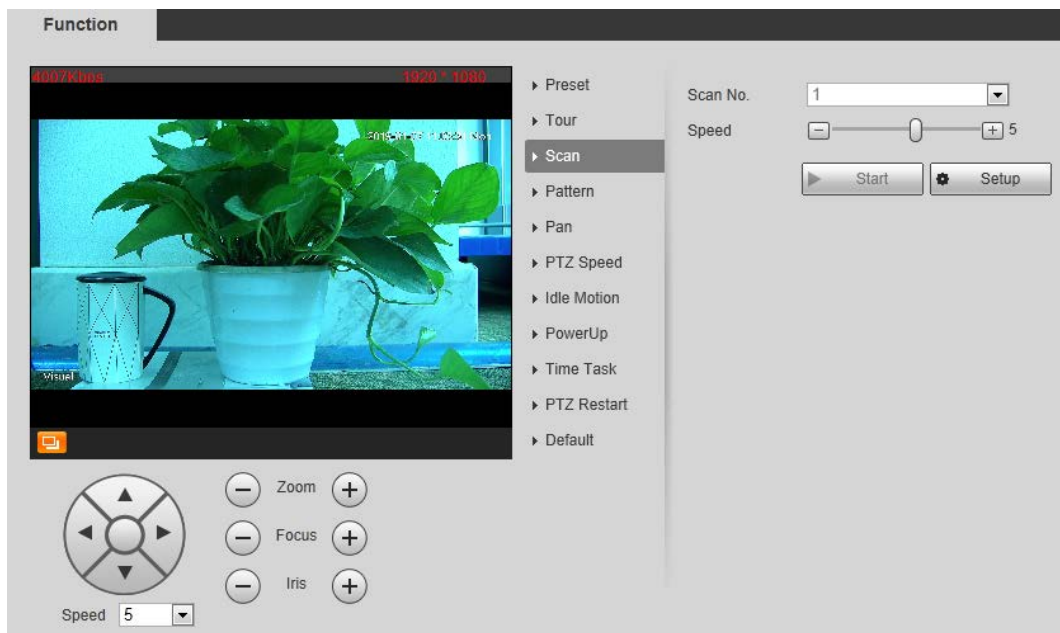

Step 2 Configure scan.

1) Select a **Scan No.** and set its **Speed**.

2) Click **Setup**.

Buttons of **Set Left Limit** and **Set Right Limit** are displayed.

3) Operate the PTZ control panel and move the camera to a left border you want and click **Set Left Limit**; move the camera to a right border you want and click **Set Right Limit**.

Step 3 Select a **Scan No.** and click **Start** to start scan.

Click **Stop** to stop the scan.

3.2.2.2.4 Configuring Pattern

The function of "pattern" can record continuously the user's manual operation to the PTZ and record the moving tracking of the camera's lens. The camera will make the location where the recording begins as the beginning point, and move back and forward automatically following the preset movement pattern.

Step 1 Select **Setting > PTZ > Function > Pattern**.

The **Pattern** interface is displayed. See Figure 3-18.

Figure 3-18 The pattern interface

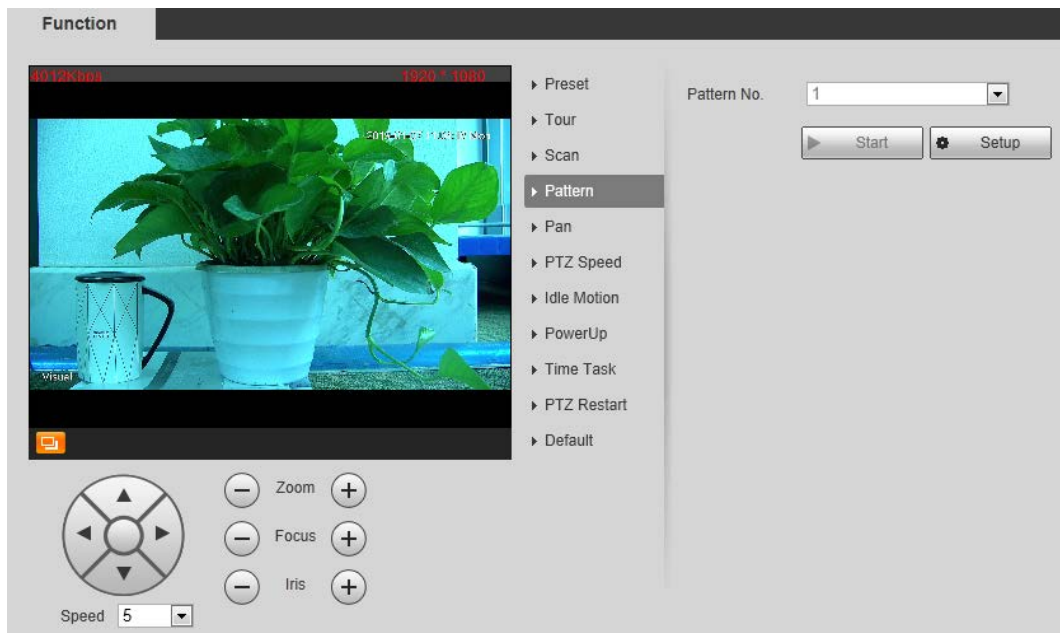

Step 2 Configure pattern.

- 1) Select a **Pattern No.**
- 2) Click **Setup**.
Buttons of **Start Rec** and **Stop Rec** are displayed.
- 3) Click **Start Rec**.
- 4) Operate the PTZ control panel and adjust you camera's direction, zoom and focus.
- 5) Click **Stop Rec**.

Step 3 Select a **Pattern No.** and click **Start** to start pattern.

Click **Stop** to stop the pattern.

3.2.2.2.5 Configuring Pan

Pan function makes your camera rotate horizontally at a speed. When you do not have enough cameras to cooperate for a wide view (a 360° view of a square, for example) or you want to learn the general situation of an area with only one camera, use the Camera pan function.

Step 1 Select **Setting > PTZ > Function > Pan**.

The **Pan** interface is displayed. See Figure 3-19.

Figure 3-19 The pan interface

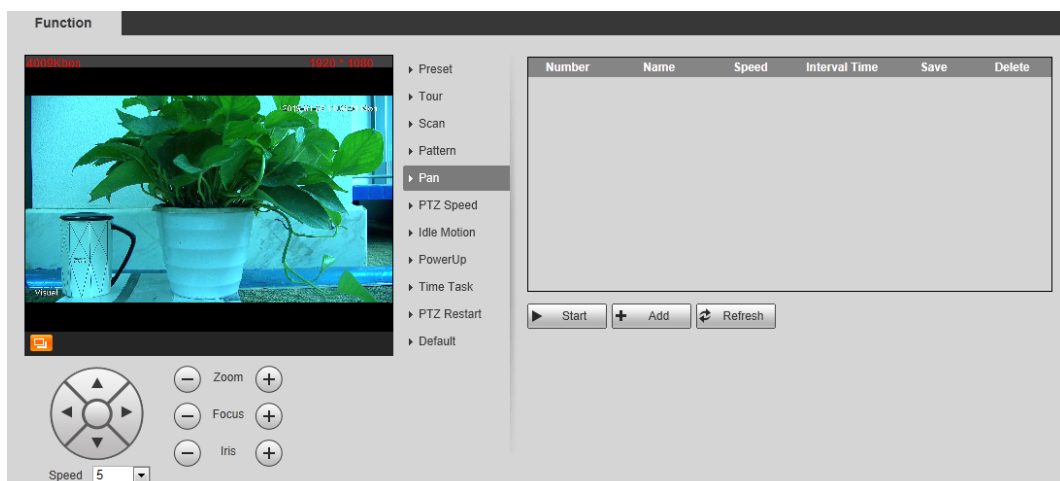

Step 2 Set a **Pan Speed**. Click **Start** to start pan.

Click **Stop** to stop the pan.

3.2.2.2.6 Configuring PTZ Speed

PTZ speed is determined by two factors—firstly and basically, the speed level (low, middle and high, marked by ① in Figure 3-20); secondly, the control panel's speed value (1, 2, 3...8 marked by ② in Figure 3-20). If you select **Low** as the **PTZ Speed** ①, then according to the maximum **Low** value, the **Speed**② will be divided into 8 parts, and it's the same for you to select **Middle** or **High** as the **PTZ Speed** ①.

Step 1 Select **Setting > PTZ > Function > PTZ Speed**.

The **PTZ Speed** interface is displayed. See Figure 3-20.

Figure 3-20 PTZ speed

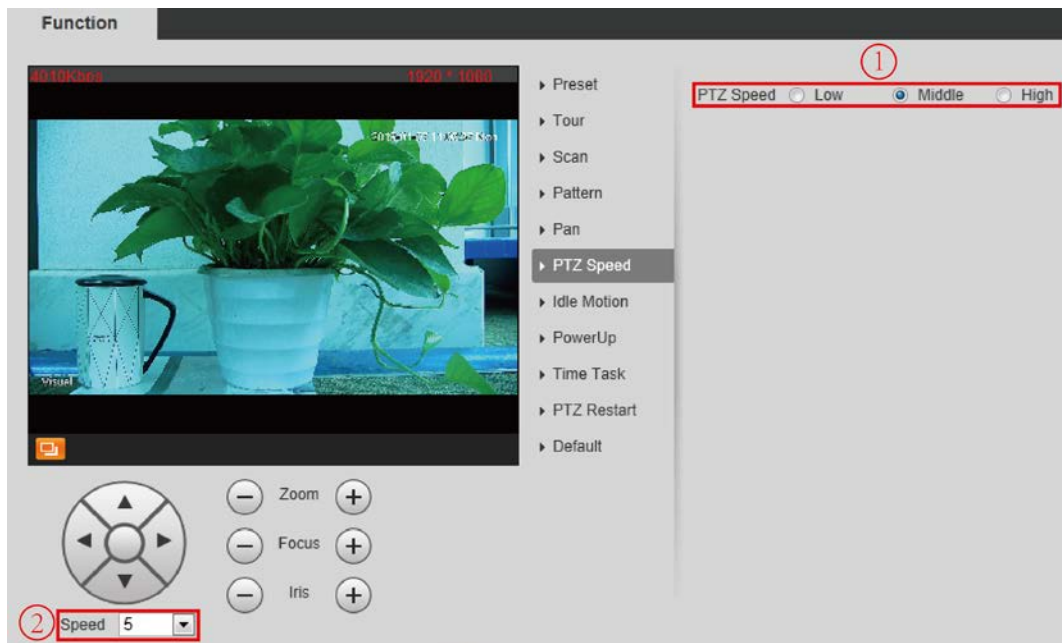

Step 2 Select from **Low**, **Middle** and **High**. The configuration takes effect immediately.

3.2.2.2.7 Configuring Idle Motion

Enable this function. And when there is a time period when PTZ does not receive any instructions, motions you have already set will be implemented.

Preparation

You have configured preset, tour, scan and pattern before configuring idle motion.

Procedure

Step 1 Select **Setting > PTZ > Function > Idle Motion**.

The **Idle Motion** interface is displayed. See Figure 3-21.

Figure 3-21 The idle motion interface

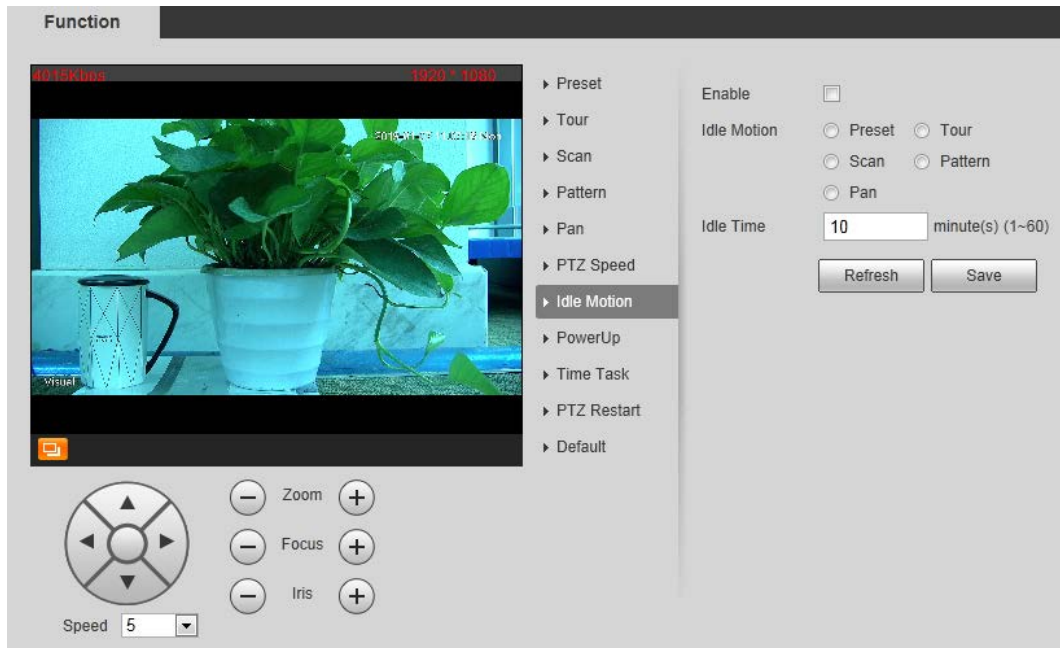

Step 2 Configure idle motion.

- 1) Select the **Enable** check box to enable this function.
- 2) Select an idle motion and set idle time.



After you have set a value of idle time, when the time when you do not operate the PTZ is longer than that value, the idle motion will be implemented immediately.

- 3) Click **Save**.

3.2.2.2.8 Configuring Power Up

If you want the PTZ to implement certain actions after the camera is powered, configure this function.

Step 1 Select **Setting > PTZ > Function > Power Up**.

The **Power Up** interface is displayed. See Figure 3-22.

Figure 3-22 Power up

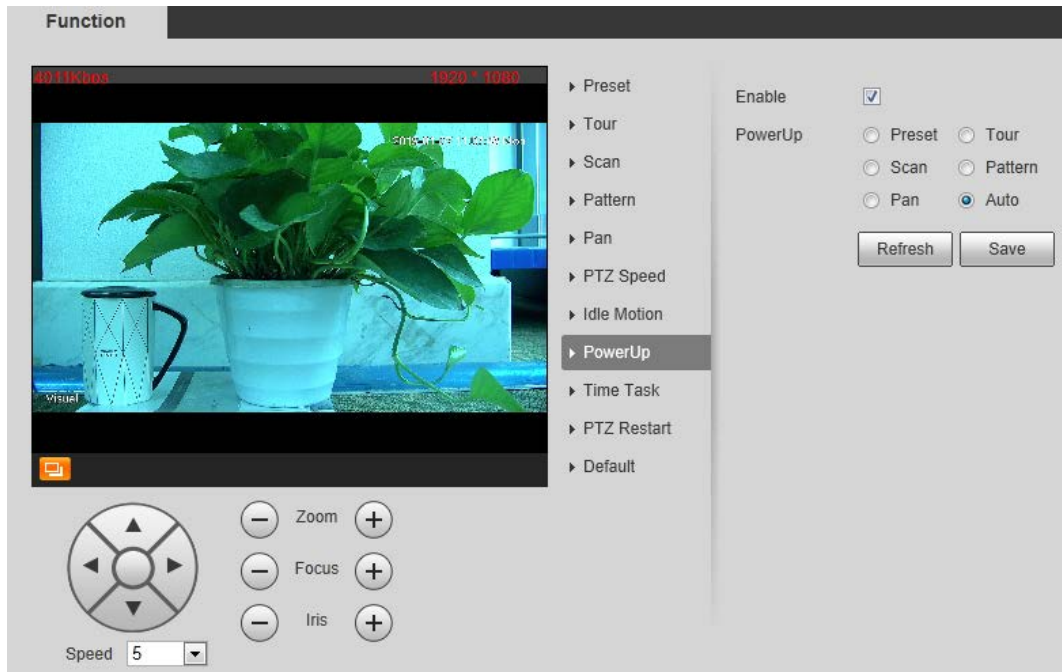

Step 2 Select the **Enable** check box.

Step 3 Select the **Power Up** actions.



Select **Auto** and the PTZ will continue to implement the action before the power is off.

Step 4 Click **Save**.

3.2.2.2.9 Configuring Time Task

You can configure a time task and let camera implement certain actions within the period you have set.

Preparation

You have configured preset, tour, scan and pattern before configuring time task.

Procedure

Step 1 Select **Setting > PTZ > Function > Time Task**.

The **Time Task** interface is displayed. See Figure 3-23.

Figure 3-23 The time task interface

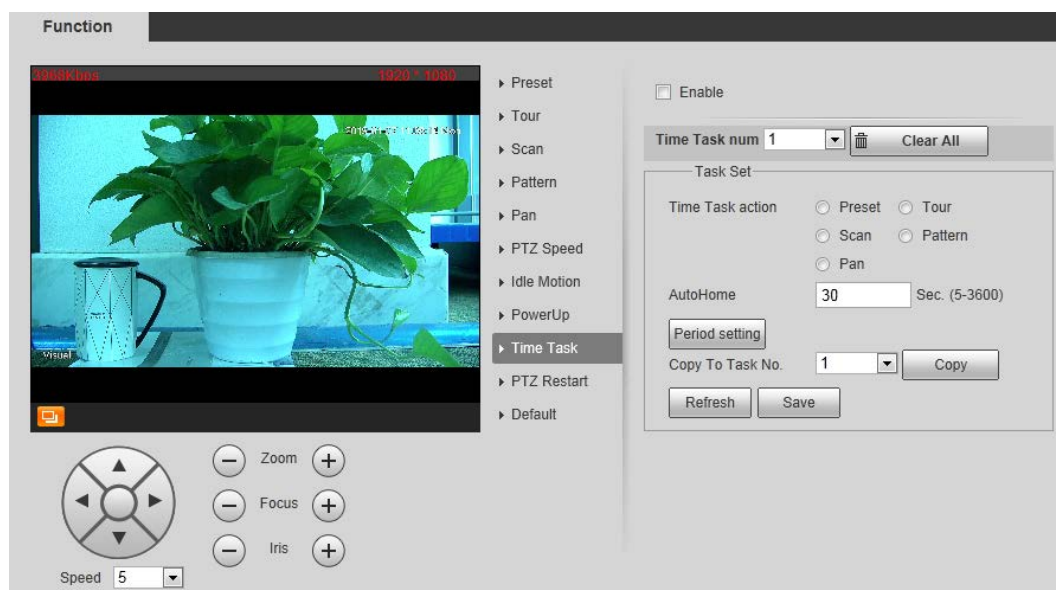

Step 2 Configure time task.

- 1) Select the **Enable** check box to enable this function.
- 2) Select a **Time Task Num**.
- 3) Select a **Time Task Action** from **Preset**, **Tour**, **Scan** and **Pattern**.



When you set **Preset** as **Time Task Action**, the **Action Number** selection box is displayed. You can select the action number based on your needs.

- 4) In the **Auto Home** selection box, set the time for the camera to return to its previous condition.



Auto home time: Time for your camera to return to its previous condition and continue the time task when the time task is interrupted by human operation.

- 5) Click **Period Setting** to set the detailed period for a time task.
- 6) Click **Save**.

Step 3 (Optional) Copy a time task.

Copy task information you have configured to other tasks.

- 1) Select a **Time Task Num** you have already configured.
- 2) In **Copy To Task No.**, select a task number to be configured.
- 3) Click **Copy**.
- 4) Click **Save** to finish task copy.

3.2.2.2.10 Restarting PTZ Manually

Step 1 Select **Setting > PTZ > Function > PTZ Restart**.

The **PTZ Restart** interface is displayed. See Figure 3-24.

Figure 3-24 The PTZ restart interface



Step 2 Click **PTZ Restart**. PTZ restarts.

3.2.2.2.11 Restoring PTZ to the Default Settings



The operations below will delete all the PTZ settings you have configured. Please be cautious.

Step 1 Select **Setting > PTZ > Function > Default**.

The **Default** interface is displayed. See Figure 3-25.

Figure 3-25 The default interface



Step 2 Click **Default**.

All your PTZ settings are restored to the default ones.

3.2.2.3 Operating PTZ



The corresponding protocol settings and function settings have been completed.

Figure 3-26 PTZ control panel

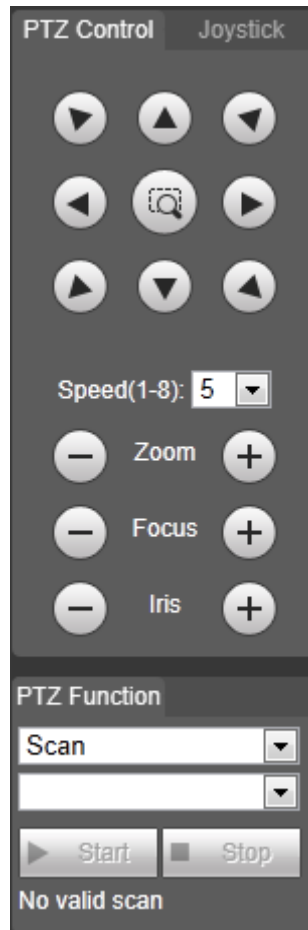



Table 3-7 Parameter description

No.	Function	Description
1	Direction button	Eight directions are contained: up, down, left, right, upper left, upper right, lower left, and lower right.
2	Speed	Controls the movement speed. The bigger the value is, the faster the movement will be. With this function, you can also change the speed of adjusting the PTZ direction, zooming, changing the focal length and adjusting the aperture.
3	Zoom, focus and iris	Click  and the zoom, focus and iris' value becomes bigger; click  and the zoom, focus and iris' value becomes smaller.
4	PTZ function	For detailed operations of PTZ, see "3.2.1.2 Configuring PTZ Functions."

3.2.2.4 Configuring Preset Backup

You can export presets you have set to back them up. When you need those presets, you can import them to your Camera and restore them.



If you want to export or import presets, you have to obey the following steps.

Step 1 Select **Setting > PTZ > Preset Backup**.

The **Preset Backup** interface is displayed.

Figure 3-27 Preset backup

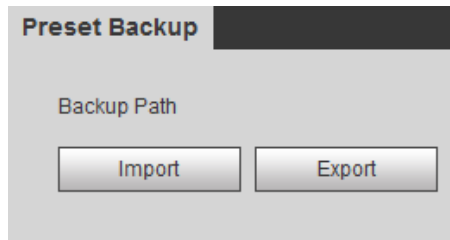

Step 2 Export or import presets.

- Click **Export** to export presets for backup.
- Click **Import** to import presets you have already backed up

3.3 Playback

Playback of both videos and pictures is supported.



Functions of different Cameras might vary, and the actual product shall prevail.

Click the **Playback** tab, and the **Playback** interface is displayed. See Figure 3-28.

Figure 3-28 Playback

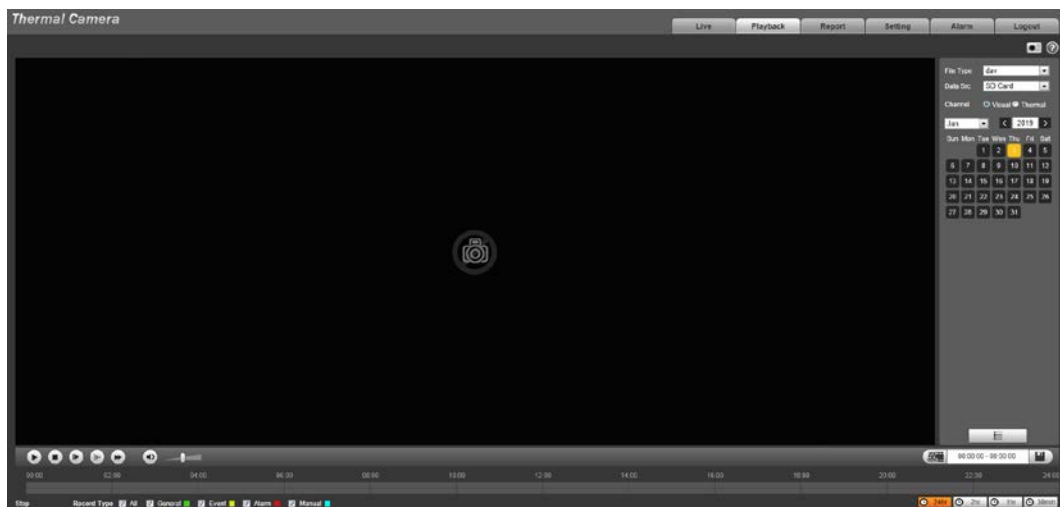

3.3.1 Video Playback

3.3.1.1 Interface Layout

Select **dav** in the **File Type** list, and the video playback interface is displayed. See Figure 3-29. On the **Playback** interface, there are seven function bars. See Table 3-8.

Figure 3-29 Video playback

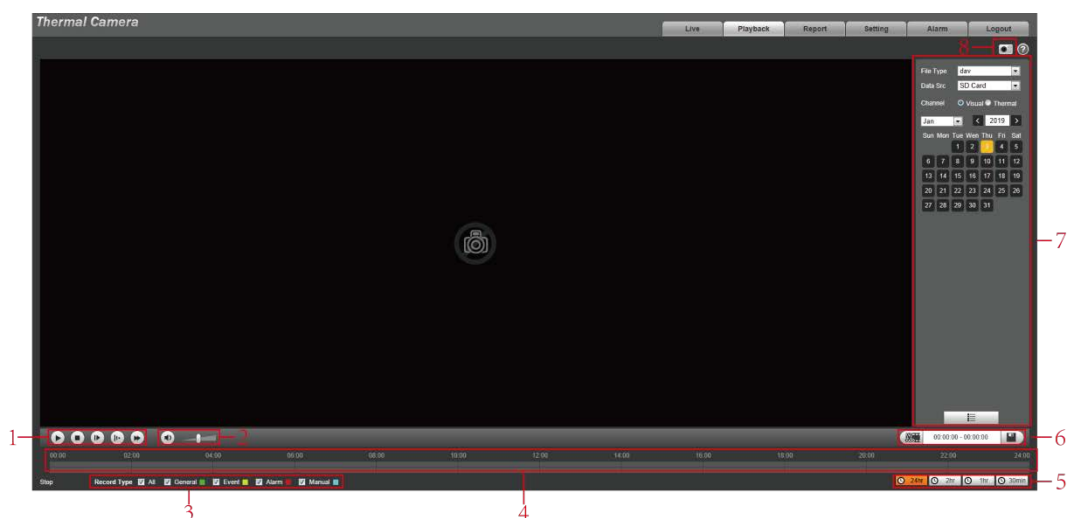















Table 3-8 Function bar description

No.	Functions	Description
1	Playback control bar	For detailed information about control buttons, see "3.3.1.2 Operate Control Bar."
2	Volume adjustment	Controls playback volume. <ul style="list-style-type: none">  muted.  muted, and the volume can be adjusted.
3	Record type	Record type includes All , General , Event , Alarm , and Manual . You can select according to your actual needs.
4	Time bar	Displays the record type and the time period. <ul style="list-style-type: none"> Click any point in the colored area, and the playback starts from this moment. Each color represents a certain video type, and the corresponding relationship is indicated in the record type selection area.
5	Time bar unit	There are four formats:  ,  ,  , and  . Take  for an example, the whole time bar has 24 hours.
6	Video clip	Clip and save certain video section. For detailed operations, see "3.3.1.4 Clipping Recorded Video."
7	Playback file list	You can select file type, data source and record date.
8	Snapshot	Click the icon to capture a live image and save it under the path you have set.

3.3.1.2 Operate Control Bar

See Table 3-9.

Table 3-9 Playback control bar

Icons	Functions	Description
	Play	Click this icon to play video.
	Stop	Click this icon to stop playback.
	Play by Frame	Click this icon to play the next frame.  You need to pause the playback before using play by frame.
	Slow playback	Click this icon to slow down the playback.
	Fast playback	Click this icon to speed up the playback.

3.3.1.3 Playing Back Videos

There are differences in operation of video playback according to the differences of data sources. Data come from SD card or your local storage.

3.3.1.3.1 Playing Back Videos in SD Card

Step 1 Select record type in the Data Src bar. See Figure 3-30.

Figure 3-30 Selecting record type



Step 2 In the **File Type** box, select **.dav**, and in the **Data Src** box, select **SD Card**. See Figure 3-31. File type contains dav and jpg. "Dav" represents video playback and "jpg" represents picture playback.

Figure 3-31 Setting files playback

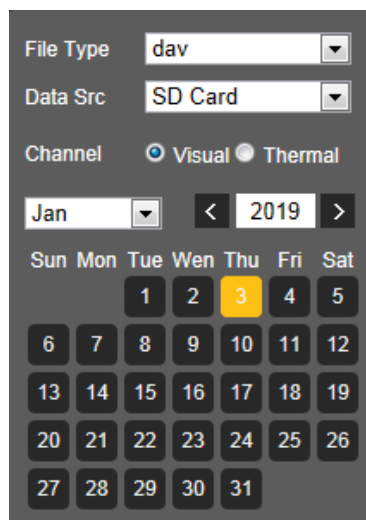

Step 3 Those dates with blue color indicate there are recorded videos in those days. Select a date with recorded video inside and its time bar is displayed.

Each color on the time bar represents a certain record type. See the matching relationship in Figure 3-30.

Step 4 Play video.



- Click  in the playback control bar.
The system plays the recorded video of the selected date (in time order).
- Click any point in the colored area of the time bar. See Figure 3-32.
The playback starts from that point.

Figure 3-32 Time bar

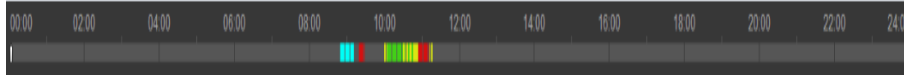

- Click , and the video files of the selected date will be listed. Double-click a file in the list. See Figure 3-33. The system plays the video and displays file size, start time and end time.

For detailed operations, see Table 3-10.

Figure 3-33 List of playback files

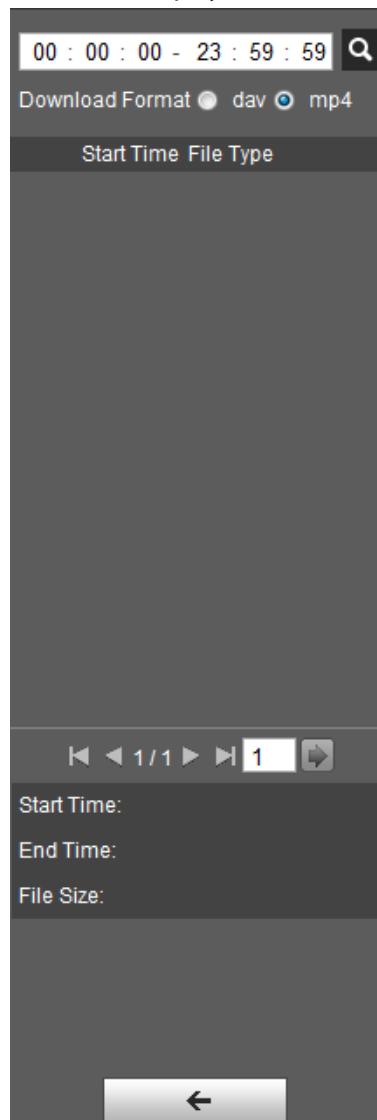





Table 3-10 Picture Playback file more operations

Operation	Description
Search	Enter start time and end time, and then click  to find out all the video files between the entered start time and end time.
Download	Select dav or mp4 in the Download Format . Then click  . The file will be downloaded to the set storage path. For detailed operations of setting the storage path, see "4.1.2.5 Configuring Storage Path."  Downloading and playing video at the same time is not supported.
Back	Click  to go back to the calendar interface.

3.3.1.3.2 Playing Back Local Videos

Step 1 In the **Data Src** box, select video type. See Figure 3-30.

Step 2 Select **dav** in **File Type**, and **Local** in **Data Src**.

List of playback files is displayed. See Figure 3-34.

Figure 3-34 List of playback files (2)

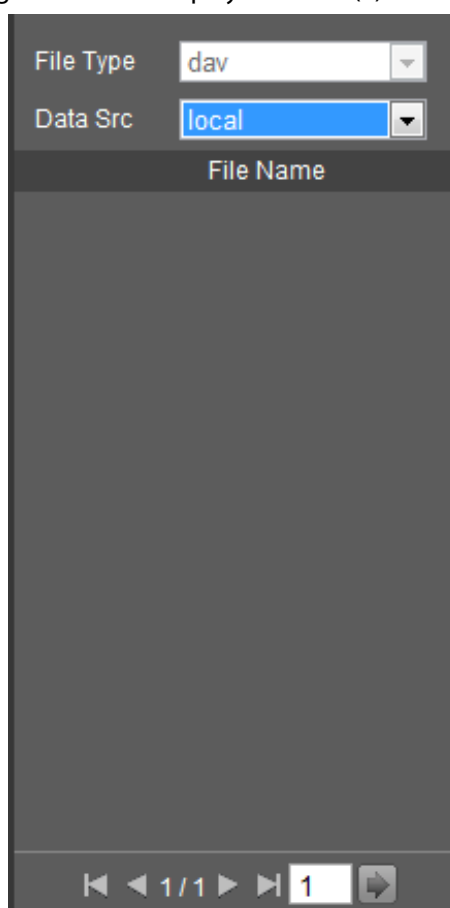

Step 3 Double-click a file and the file is displayed.

3.3.1.4 Clipping Recorded Videos

You can clip a part of recorded video and save it under the path you have set. See Figure 3-35.

Figure 3-35 Video clipping



Step 1 In **Video Format**, select **dav** or **mp4**.

Step 2 Click on the time bar to select the start time, and then click  to start.

Step 3 Click again on the time bar to select the end time, and then click  to finish.

Step 4 Click .

The system prompts that you cannot play back and download a recorded video at the same time.

Step 5 Click **Save**.

The system stops playback and save the edited file under the storage path you have set. For detailed operations of setting the storage path, see "4.1.2.5 Configuring Storage Path".

3.3.2 Picture Playback

The following content is about the introduction of the interface function bar and how to play back pictures.

3.3.2.1 Interface Layout

Select "jpg" in "file type" list, and the **Picture Playback** interface is displayed. See Figure 3-36.

Figure 3-36 Image playback

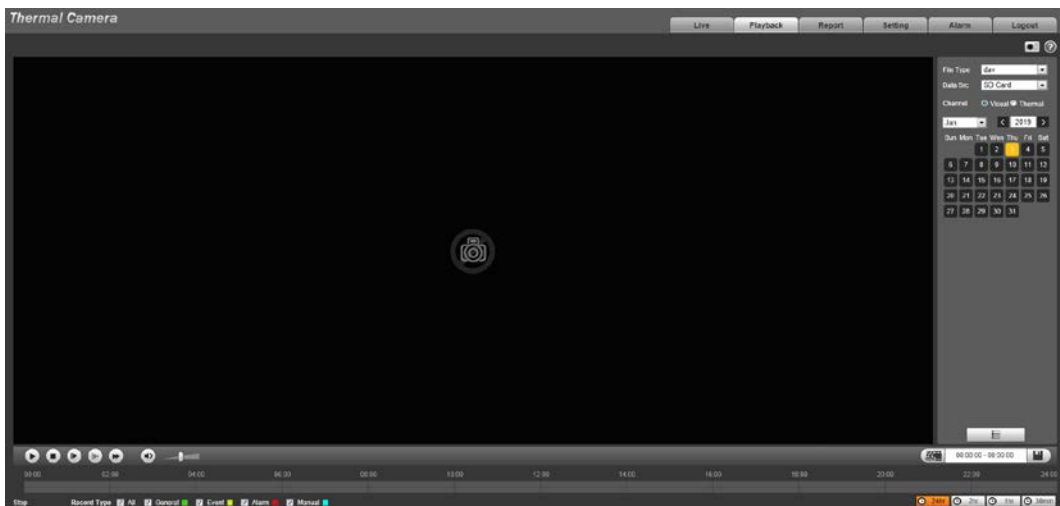



Table 3-11 Image playback

No.	Function	Description
1	Control button for playing pictures	Includes the following two types: <ul style="list-style-type: none">  When this icon displays, the picture playback is paused or not started. Click this icon to start picture playback.  When this icon displays, the picture playback is ongoing. Click this icon to stop picture playback. The two states above can be switched.
2	Snapshot type selection	There are three types including General , Event and Alarm , and you can select one of them according to actual needs.
3	Playback file list	You can select file type and snapshot data.

3.3.2.2 Picture Playback

You can check and play a snapshot image based on your own needs.

Step 1 Select a snapshot type in the selection bar of snapshot type. See Figure 3-37.

Figure 3-37 Snapshot type selection

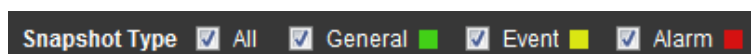

Step 2 Select **jpg** in **File Type**. See Figure 3-38.

File type contains dav and jpg. "Dav" represents video playback and "jpg" represents image playback.

Figure 3-38 Configuring playback files

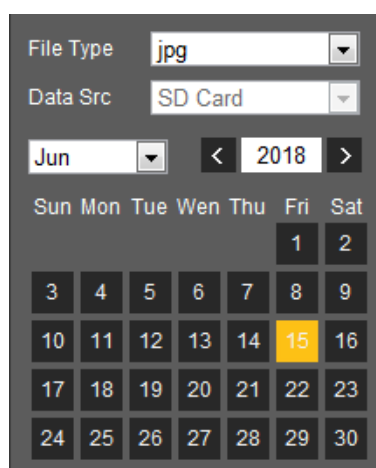

Step 3 Those dates with blue color indicate there are snapshot images in those days. Select a date with snapshot images inside.

Step 4 Play images.







- Click  in the play control bar and the system plays the snapshots you have selected (in time order).
- Click  which represents the file list, pictures which you have selected would be displayed. Double-click a file in the list. See Figure 3-39. The file is displayed. For detailed operations, see Table 3-12.

Figure 3-39 List of playback files



Table 3-12 Picture Playback file more operations

Operation	Description
Search	Enter starting time and ending time, and click  . Finds out all the picture files between the entered starting time and ending time.
Download	Click  , and the file is downloaded to local host.  The download operation might vary with different browsers, and the actual interface shall prevail.
Back	Click  to go back to the calendar interface.

3.4 Reports

You can follow certain rules such as time sequence, and check history data of temperature saved in the Camera Micro SD card.

Preparation

- You have set the temperature measuring rules (spots, lines and area included). For detailed operations, see "4.6.1.1 Configuring Temperature Measuring Rules".
- You have inserted a SD card to the Camera.



Some Cameras do not support this function. The actual product shall prevail.

Procedure

Step 1 Click the **Report** tab.

The **Report** interface is displayed. See Figure 3-40.

Figure 3-40 Report

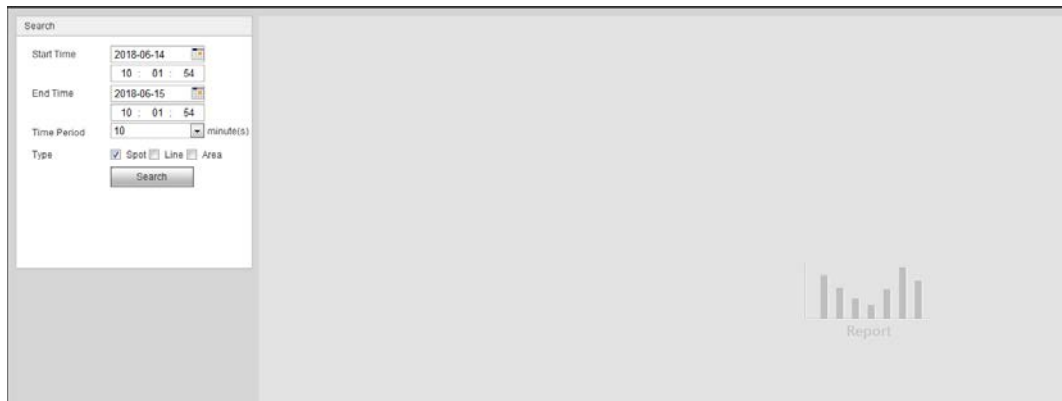

Step 2 Set the conditions for searching and click **Search**.

Temperature data you have searched is displayed. See Figure 3-41.

Figure 3-41 Result of report searching

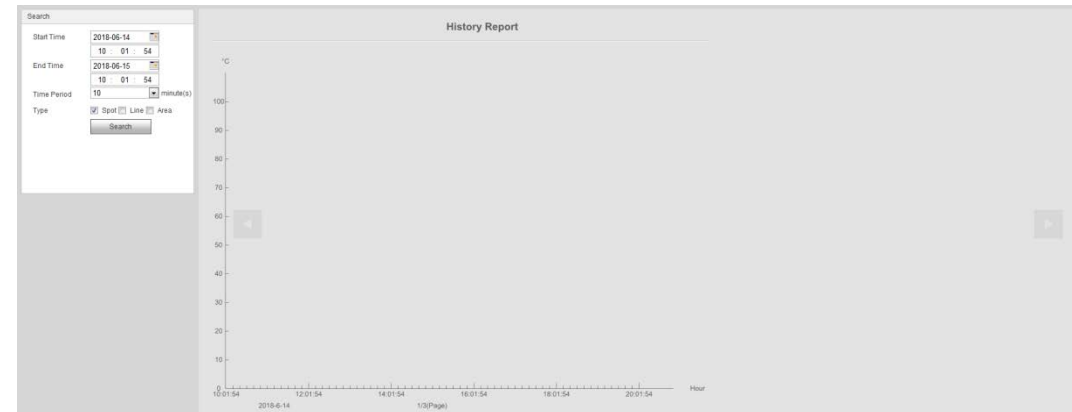

3.5 Alarm

You can select alarm type as needed, when the selected alarms are triggered, the system would record detailed alarm information at the right side of the interface.



Function of different Cameras might vary, and the actual product shall prevail.

3.5.1 Introduction to Alarm Types

For alarm types and conditions that trigger an alarm, see Table 3-13.

Table 3-13 Alarm type description

Alarm Type	Description	Condition
Motion detection	The alarm is triggered when moving objects are detected.	You have enabled motion detection. For detailed operations, see "4.5.1 Configuring Video Detection."

Disk full	The alarm is triggered when the free space in the SD card is lower than the set percentage.	You have enabled detection to lack of SD card storage space. For detailed operations, see "4.5.5.1 Configuring SD Card Abnormality Parameters."
Disk error	The alarm is triggered when there is SD card error or abnormality.	You have enabled detection to SD card storage space. For detailed operations, see "4.5.5.1 Configuring SD Card Abnormality Parameters."
External alarm	The alarm is triggered when there is alarm from external Camera.	There is an alarm input port and the external alarm is enabled. For detailed operations, see "4.5.4 Configuring Alarm."
Illegal access	The alarm is triggered when the login password has been wrongly entered for more than the set times.	You have enabled detection to illegal access. For detailed operations, see "4.5.5.3 Configuring Illegal Access."
Audio detection	Alarm is triggered when there are audio input errors.	You have enabled detection to audio errors. For detailed operations, see "4.5.2 Configuring Audio Detection."
IVS	Alarm is triggered when the set smart plans are triggered.	You have enabled detection to general behaviors. For detailed operations, see "4.4.2 Configuring " "
Fire warning	Alarm is triggered when fire is detected.	You have enabled fire alarm. For detailed operation, see "4.4.6 Configuring Fire Warning."
Temperature alarm	When temperature satisfies alarm conditions stipulated by temperature testing rules, alarm is triggered.	You have enabled temperature alarm. For detailed operations, see "4.5.3 Configuring Temperature Alarm."
Temperature difference alarm	When temperature difference satisfies alarm condition you have set, alarm is triggered.	You have enabled temperature comparison alarm. For detailed operations, see "4.5.3 Configuring Temperature Alarm."
Hot spot alarm	When temperature of a hot spot satisfies alarm condition you have set, alarm is triggered.	You have enabled hot/cold spot tracing. For detailed operations, see "4.4.7 Configuring Hot Trace."
Cold spot alarm	When temperature of a cold spot satisfies alarm condition you have set, alarm is triggered.	

3.5.2 Subscribing Alarm Information

You can enable alarm prompts and define alarm sound according to your preference.

Step 1 Click the **Alarm** tab.

The **Alarm** interface is displayed. See Figure 3-42.

Figure 3-42 Alarm



Step 2 Select an alarm type.

Step 3 Select **Prompt**, and the system prompts and records alarm information as needed.

- If you are not in the **Alarm** interface when alarm events you have subscribed are triggered, there will be a  displayed on the **Alarm** tab and the alarm information will be recorded. Click the **Alarm** tab, and the sign disappears.
- If you are at the “Alarm” interface when the selected alarm is triggered, there will be detailed alarm information displayed at the right side of the interface.

Step 4 Select the check box of **Play Alarm Tone**, and select audio file.

System would play the audio file you have selected, when alarm events you have subscribed are triggered.



Click **Remove all** to remove all the alarm information.

4 Setting



- Functions of different Cameras might vary, and the actual product shall prevail.
- Click **Default**, and the Camera is restored to default configuration. Click **Refresh** to view the latest configuration.

4.1 Configuring Camera

Configure camera's components such as lens, video and audio to ensure proper surveillance.

4.1.1 Configuring Lens

4.1.1.1 Configuring Visible Image

4.1.1.1.1 Configuring Picture Parameters

You can configure the picture parameters including brightness, contrast, saturation, Chroma CNT, sharpness CNT and gamma.

Step 1 Click the **Picture** tab.

The **Picture** interface is displayed. See Figure 4-1.

Figure 4-1 The picture interface

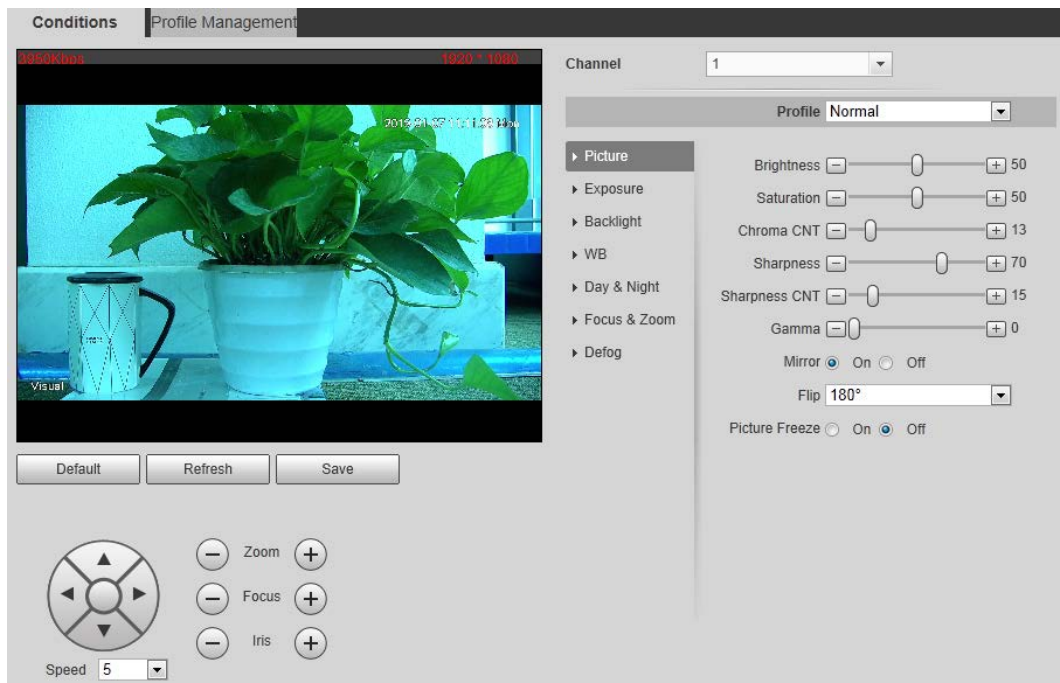

Step 2 Configure picture parameters. See Table 4-1.

Table 4-1 Description of picture parameters

Parameter	Description
Style	Select display style of the video image, including Soft , Standard and Vivid .

Brightness	Changes the value to adjust the picture brightness. The bigger the value is, the brighter the picture will be.
Contrast	Changes the contrast of the picture. The bigger the value is, the more the contrast will be between bright and dark areas.
Saturation	Makes the color deeper or lighter. The bigger the value is, the deeper the color will be. Saturation value doesn't change image brightness.
Chroma CNT	Reduces the image color and prevents it from being too strong. The bigger the value, the better the effect.
Sharpness	Changes the sharpness of picture edges. The bigger the value is, the clearer the picture edges will be, and if the value is set too big, picture noises are more likely to appear.
Sharpness CNT	The bigger the value, the stronger the sharpness CNT.
Gamma	Changes the picture brightness and improves the picture dynamic range in a non-linear way. The bigger the value is, the brighter the picture will be.
Flip	In the Flip list, select 180° and the video image will be turned upside down. Select 0° and the video image returns to its primary condition.
EIS	Select the On check box to enable this function. Corrects the Camera shaking with difference comparison algorithm and improves the image clarity, effectively solves the picture shaking problem.

4.1.1.1.2 Configuring Exposure

Step 1 Click the **Exposure** tab.

The **Exposure** interface is displayed. See Figure 4-2.

Figure 4-2 The exposure interface

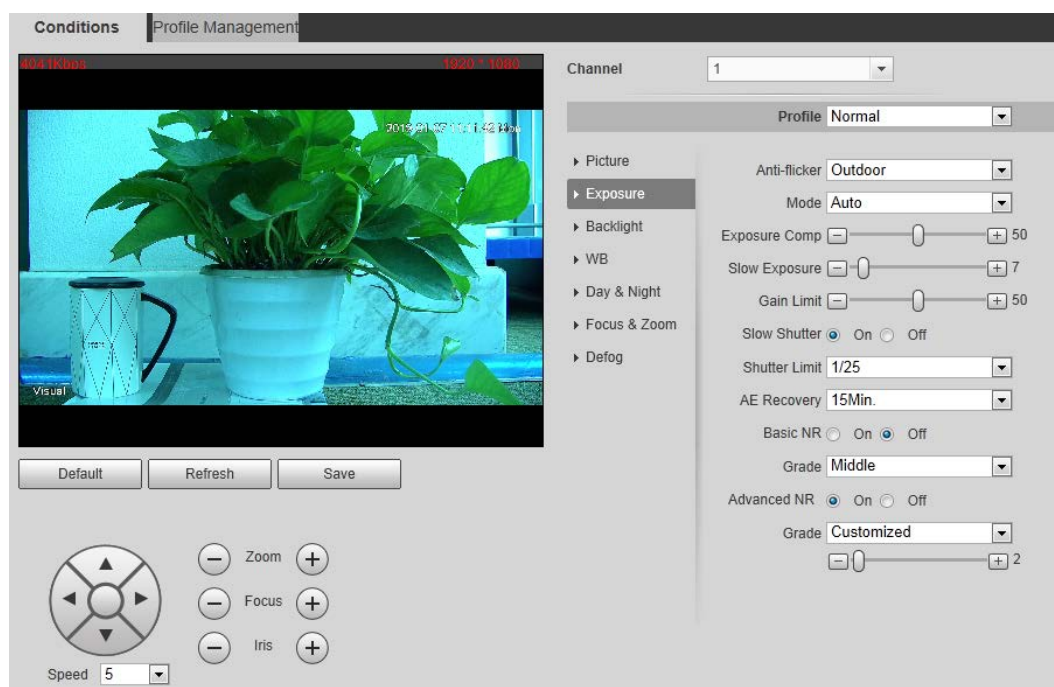

Step 2 Configure exposure parameters. See Table 4-2.



Parameters and its description in Table 4-2 are based on the condition that you have selected **Standard** as **Profile**.

Table 4-2 Description of exposure parameters

Parameter	Description
Mode	<ul style="list-style-type: none"> • Auto: Adjusts the image brightness according to the actual condition automatically. • Shutter priority: When the exposure range is normal, the system prefers the configured shutter range when auto adjusting according to the ambient lighting condition. If the image brightness is not enough and the shutter value has reached upper or lower limit, the system adjusts gain value automatically to ensure the image at ideal brightness. • Iris priority: The iris value is set to a fixed value, and the Camera adjusts shutter value then. If the image brightness is not enough and the shutter value has reached upper or lower limit, the system adjusts gain value automatically to ensure the image at ideal brightness. • Manual: Configure gain and shutter value manually to adjust image brightness.
Anti-flicker	<ul style="list-style-type: none"> • 50Hz: When the current is 50Hz, the system adjusts the exposure according to ambient light automatically to ensure there is no stripe appears. • 60Hz: When the current is 60Hz, the system adjusts the exposure according to ambient light automatically to ensure there is no stripe appears. • Outdoor: You can select any exposure mode as needed.
Iris	Select Manual or Aperture Priority as the Mode . Then you can configure the iris parameter.
Exposure Comp	Select Manual , Aperture Priority or Shutter Priority as the Mode . Then you can configure the exposure compensation parameter.
AE (Auto Exposure) Recovery	<p>Set a recovery time. After you adjust the shutter manually, the exposure mode will be restored to the default one after the time you have set.</p>  <p>In the selection box of AE Recovery, you can select Off to turn off AE recovery.</p>
Shutter	<p>Set Manual or Shutter Priority as the Mode. Then you can configure the parameter.</p> <p>Adjust the camera's shutter value.</p>
2D NR	Select the On check box to enable this function. Aiming at single-frame image, 2D NR averages the pixel points (points that are with image noise) with other common pixel points to decrease the image noise and achieve an acceptable and good image display effect. The higher the grade, the better the noise suppression effect.
3D NR	Select the On check box to enable this function. Aiming at multiple-frame image, 3D NR handles information between two frames to reduce the image noise. The higher the grade, the better the noise suppression effect.

4.1.1.1.3 Configuring Backlight

Backlight mode is divided into **BLC**, **HLC** and **WDR**. You can select one from the three options above at one time.

- When in BLC mode, the camera gets clearer image of the dark areas on the target when shooting against light.

- When in WDR mode, the camera constrains over bright areas and compensates dark areas to improve the image clarity.
- When in HLS mode, the camera dims strong light, and it is applicable to the exit of toll station or parking lot. This mode works well for taking pictures of human face or car plate detail under extreme low ambient light.

Step 1 Click the **Backlight** tab.

The **Backlight** interface is displayed. See Figure 4-3.

Figure 4-3 The backlight interface

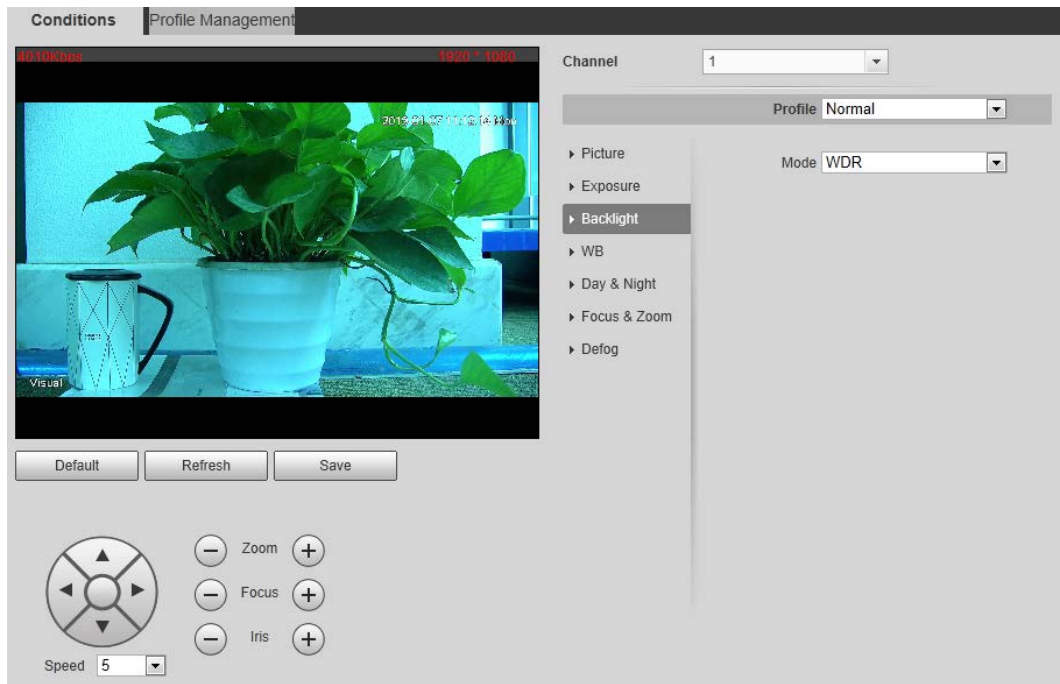

Step 2 Configure backlight parameters. See Table 4-3.



There might be a few seconds of video loss when the Camera is switching to WDR mode from other modes.

Table 4-3 Backlight mode description

Backlight Mode	Description
BLC	The system adjusts exposure according to ambient lighting condition automatically to ensure the clarity of the darkest area.
WDR	The system dims bright areas and compensates dark areas to ensure the clarity of all the area.
HLS	The system constrains bright areas and reduces halo size to dim the overall brightness.

4.1.1.1.4 Configuring White Balance

With the white balance technology, you can make a white object display itself clearly on the video image under all kinds of environment.

Step 1 Click the **WB** tab.

The **WB** interface is displayed. See Figure 4-4.

Figure 4-4 The WB interface

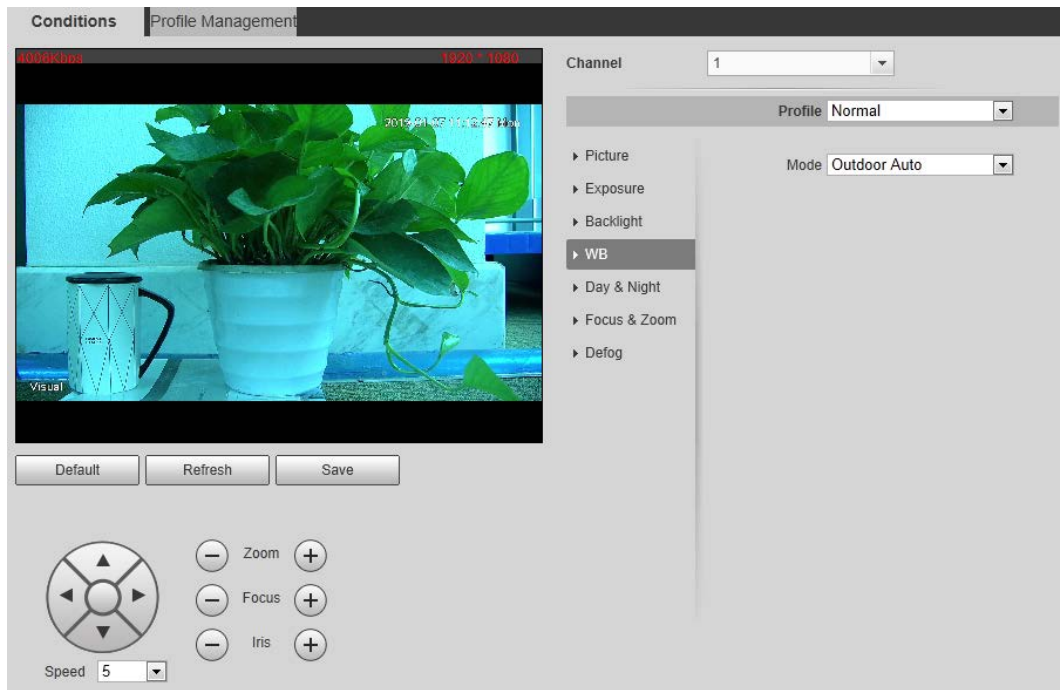

Step 2 Configure white balance parameters. See Table 4-4.

Table 4-4 WB mode description

WB Mode	Description
Auto	The system compensates WB according to light condition to ensure color precision.
Outdoor	The system auto compensates WB to most outdoor environments with natural or artificial light to ensure color precision.
Manual	Configure red and blue gain manually; the system auto compensates WB according to color temperature.
Natural	The system auto compensates WB to environments without artificial light to ensure color precision.
Street Lamp	The camera will implement white balance to ensure precision and clarity of the video image.

4.1.1.1.5 Configuring Day & Night

You can configure this function to accomplish the switch of image display between color mode and black/white mode.

Step 1 Click the **Day & Night** tab.

The **Day & Night** interface is displayed. See Figure 4-5.

Figure 4-5 The day & night interface

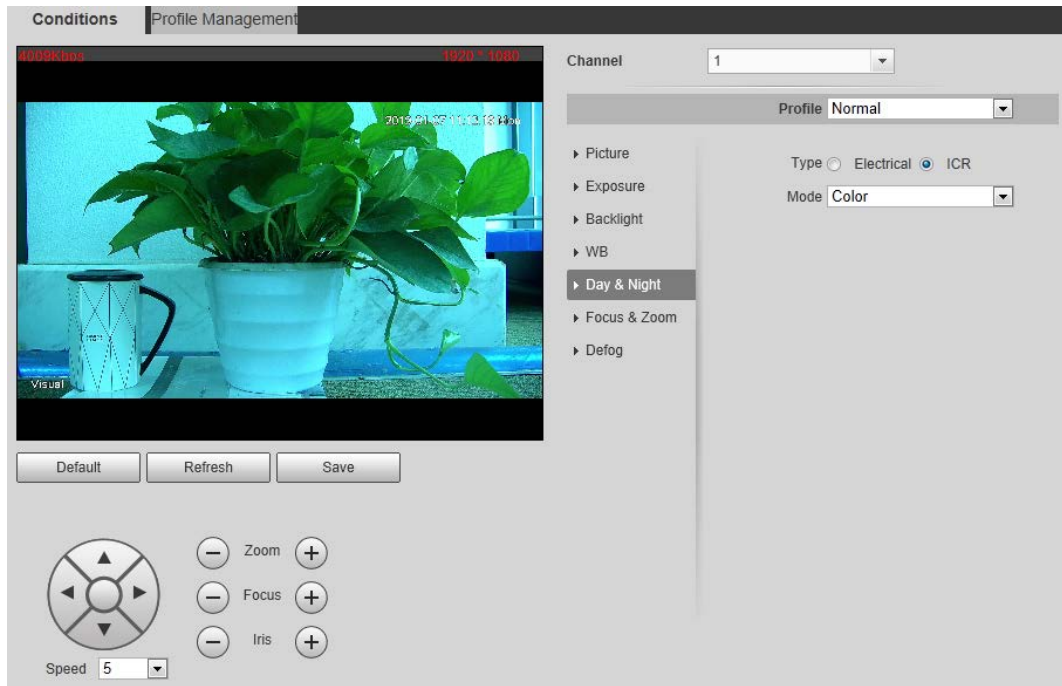

Step 2 Configure day & night parameters. See Table 4-5.

Table 4-5 Day & night mode description

Parameter	Description
Type	Select Type from Electrical and ICR .
Mode	<p>You can select Camera display mode from Color, Auto and B/W.</p> <p> Day & night configuration is independent from profile management configuration.</p> <ul style="list-style-type: none"> • Color: The system displays color image. • Auto: The system switches between color and black-and-white display according to the actual condition. • B/W: The system displays black-and-white image.
Sensitivity	<p>Select Auto as the Mode. Then You can configure this parameter.</p> <p>You can configure camera sensitivity in switching between color and black-and-white mode.</p>

4.1.1.1.6 Configuring Focus & Zoom

Step 1 Click the **Focus & Zoom** tab.
The **Focus & Zoom** interface is displayed. See Figure 4-6.

Figure 4-6 The focus & zoom interface

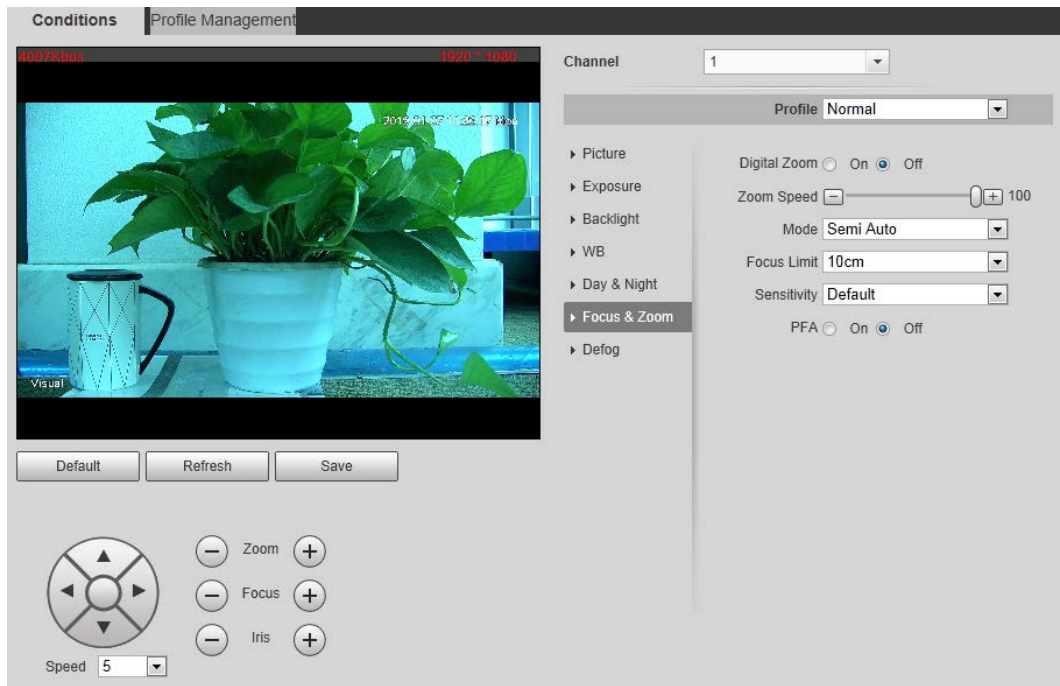

Step 2 Configure the focus & zoom parameters. See Table 4-6.

Table 4-6 Description of focus & zoom parameters

Parameter	Description
Digital Zoom	Select the On check box to enable it. You can use the digital zoom to continue the zooming operation even if the optical zoom is at the maximum value.
Zoom Speed	The larger the value, the faster the zooming operation.
Mode	The camera's focusing mode. <ul style="list-style-type: none"> Auto: Once there is any movement or change of an object on the video image and the image turns blurry, the camera will focus again automatically. Semi Auto: A user needs to prepare some conditions for the camera to focus automatically. This is called "Semi Auto." Pressing the focusing button, implementing the zooming operation, enabling preset or three-dimensional positioning, and PTZ's rotation will all make the camera focus again automatically. Manual: You need to click or on the camera's web to achieve the focusing operation.
Focus Limit	The camera's minimum focusing distance. If the focusing distance is too small, it might get the camera focus on its dome.
Sensitivity	Select from High , Default and Low . When you select High , it will be easier for the camera to focus.
PFA	Select the check box of On to enable the infrared correction. Then when you implement the zooming or focusing operation under low lighting condition, the camera will turn on the infrared light to aid you.
Lens Init	Click Lens Init to initialize the lens. The system will clear the zooming and focusing data you have set.

4.1.1.1.7 Configuring Defog

The image quality will be compromised in foggy or hazy environment, and defog can be used then to improve image clarity.

Step 1 Click the **Defog** tab.

The **Defog** interface is displayed. See Figure 4-7.

Figure 4-7 The defog interface

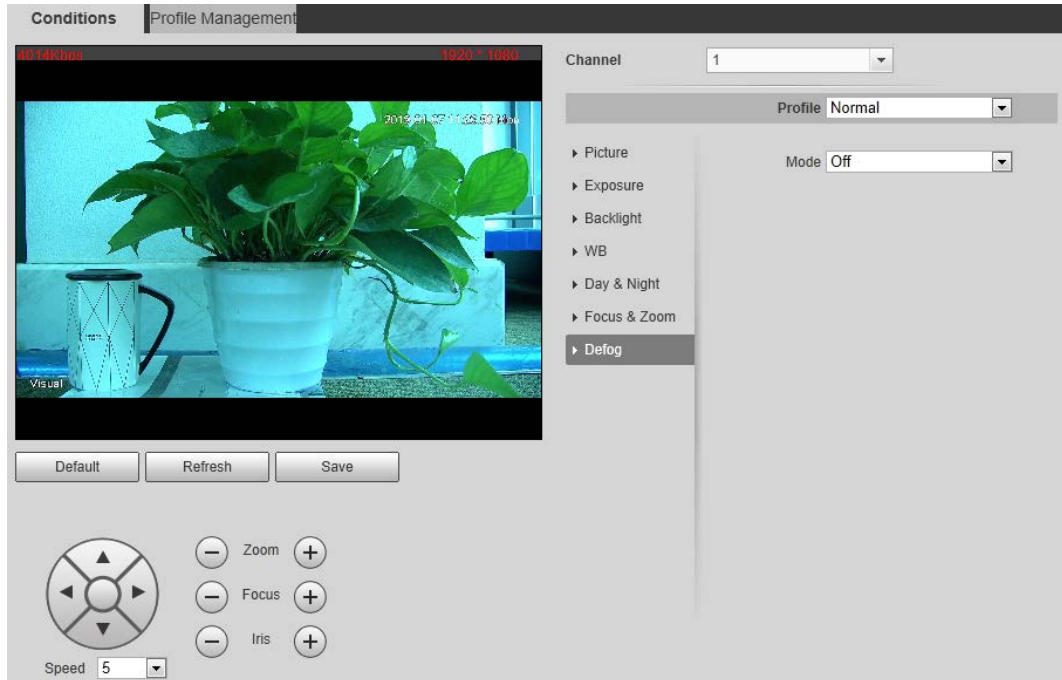

Step 2 Configure the defogging settings. See Table 4-7.

Table 4-7 Defogging settings description

Defogging Settings	Description
Auto	The system adjusts image clarity according to the actual condition.
Manual	Adjust image clarity manually.
Off	Defogging function disabled.

4.1.1.1.8 Restoring Lens to the Default Settings

After you have modified lens parameters as mentioned above in 4.1.1.1, if you find situations such as unclear images and abnormal colors, you can restore those parameters to the default settings—you just need to click the **Default** button and click **Save**. See Figure 4-8.

Figure 4-8 Restoring lens to the default settings

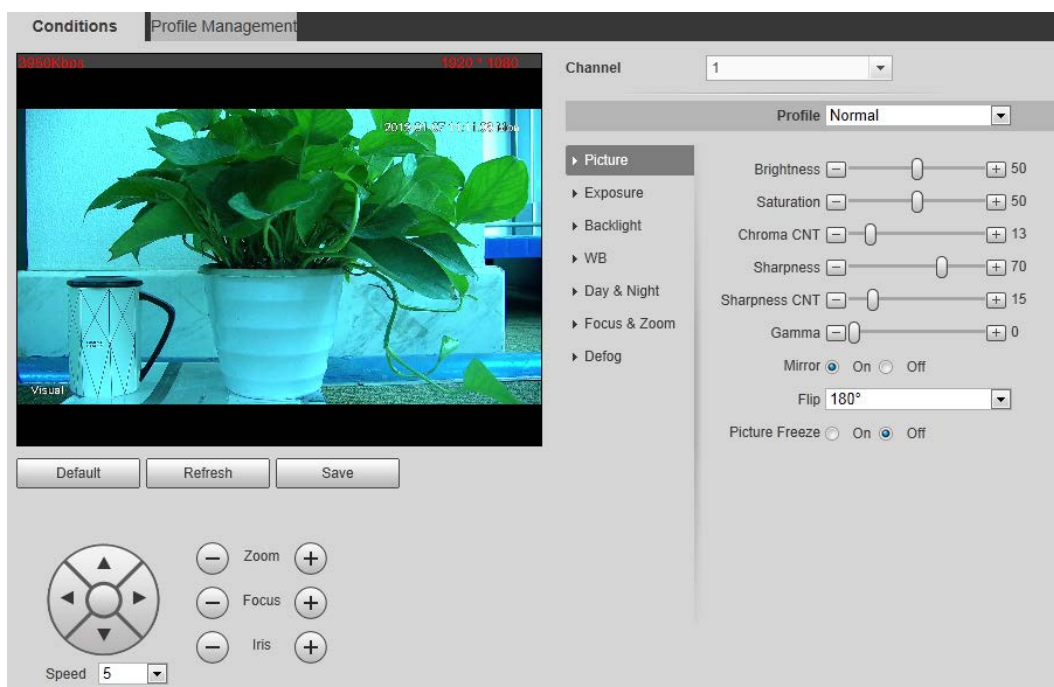

4.1.1.2 Configuring Thermal Image



To find and configure thermal image, you need to select **Setting > Camera > Conditions > Conditions** first, and in the **Channel** box, select **2**. See the following steps.

Configure a specific scenario where you use the camera, including indoor scenario, outdoor scenario, and adaptive scenario. You can choose a scenario you need, and configure and check the scenario.

Step 1 Select **Setting > Camera > Conditions > Conditions**.

The **Conditions** interface is displayed.

Step 2 In the **Channel** box, select **2**.

The thermal image interface is displayed. See Figure 4-9.



The thermal image interface might vary with different cameras, and the actual product shall prevail.

Figure 4-9 The thermal image interface

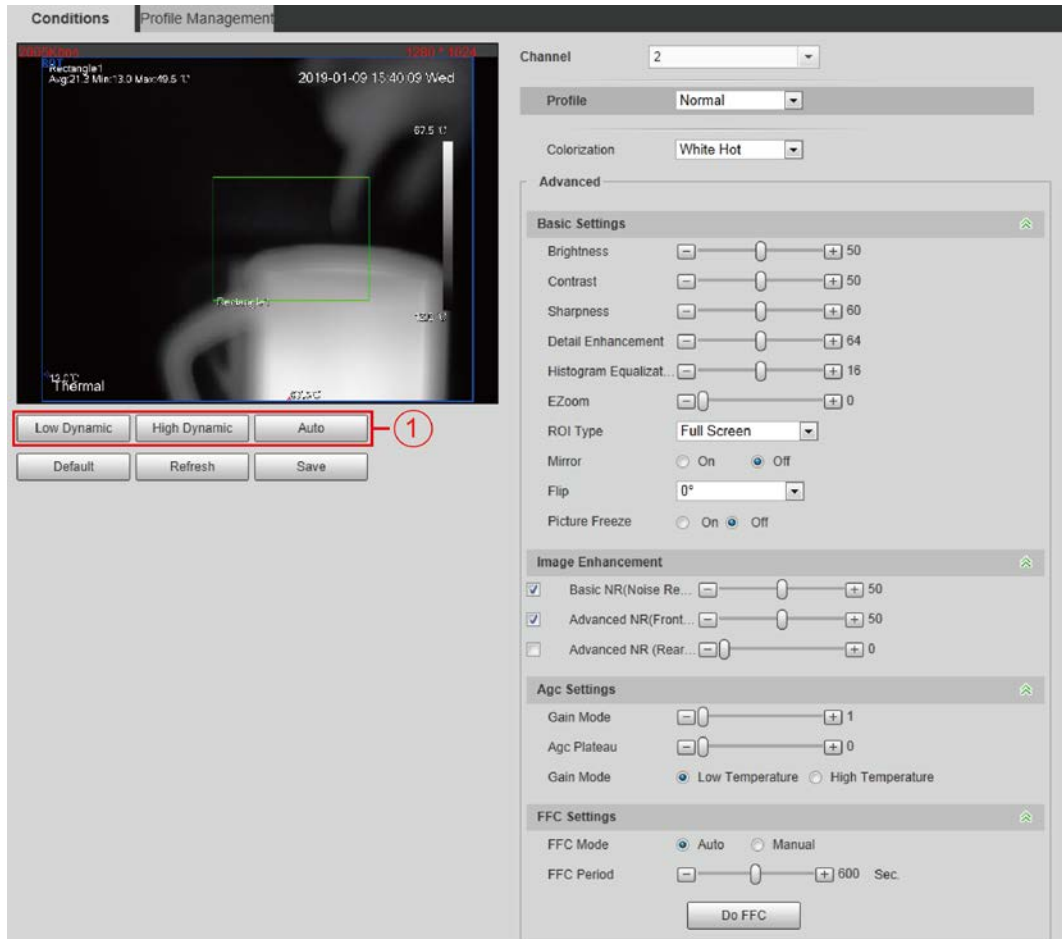

Step 3 Configure lens parameters. See Table 4-8.

Table 4-8 Parameter description of lens

Classification	Parameter	Description
Profile	Profile	Normal, Day and Night can be selected.
	Scene (marked by ① in Figure 4-9)	Select the duplicate frame and set the frequently used video parameter as the user-defined scene. Or, you can select the default scene and set the display of the thermal image. <ul style="list-style-type: none"> ● Low Dynamic: Thermal images will be displayed based on the configuration of low dynamic scene. ● High Dynamic: Thermal images will be displayed based on the configuration of high dynamic scene. ● Auto: Thermal images will be displayed based on the configuration of auto scene.

Basic Settings	Colorization	<p>Add color to the thermal image and use color to indicate the temperature. "White glow" is the default color.</p> <ul style="list-style-type: none"> • White glow: Lighter when the temperature is higher in gray image. • Black glow: Lighter when the temperature is lower in gray image. • Fusion: Color is concentrated on the range of purple-red-yellow. More purple when the temperature is lower and more yellow when the temperature is higher. • Rainbow: Color is concentrated on the range of blue-green-red-yellow. Bluer when the temperature is lower and more yellow when the temperature is higher. • Golden autumn: Color is concentrated on the range of red- yellow. Redder when the temperature is lower and more yellow when the temperature is higher. • Midday: Color is concentrated on the range of blue-green-red-yellow. Bluer when the temperature is lower and more yellow when the temperature is higher. • Iron oxide red: Its color range is similar to that of Midday, but its brightness is lower than Midday. • Amber: It's mainly represented as brown. Brighter when the temperature is higher. • Boulder: Color is concentrated on the range of purple - red- yellow-green- blue. More purple when the temperature is lower and bluer when the temperature is higher. • The setting sun: Color is concentrated on the range of blue- red- yellow. Bluer when the temperature is lower and more yellow when the temperature is higher. • Ice and fire: In color image, high temperature objects show red and low temperature objects show blue. Ice and fire is usually used to give a warning. • Oil painting: Color is concentrated on the range of purple-blue-green- yellow-red. More purple when the temperature is lower and redder when the temperature is higher. • Pomegranate: It's mainly represented as wine red. Brighter when the temperature is higher. • Green jade: It's mainly represented as aquamarine. Brighter when the temperature is higher.
	Brightness	<p>Change the overall image brightness through linear mode. The bigger the value is, the brighter the image will be, and the smaller the darker.</p>
	Sharpness	<p>Change the sharpness of image edges. The larger the value, the more obvious the image edge.</p> <p>Do not make the value too large to prevent image noise.</p>

	EZoom	Enlarge the thermal image according to the zoom time you have set.
	ROI Type	Select the district of strengthening video quality. The brightness and clarity of the chosen district will be higher. District consists of 25% central point, 50% central point, 75% central point, full screen, bottom part, middle part, above part and user-defined part. When you set ROI Type to Custom , you need to press and drag the left mouse button. Then, add the "ROI Type" box.
	Mirror	Open the mirror image and the monitor image will reverse from left to right.
	Picture Freeze	When you are using the preset, the preset image that has been used will be directly represented. The image during the movement of PTZ will not be displayed.
	Basic NR (Noise Reduction)	Average the pixel of single frame image with other pixels to reduce the image noise. Select the copy frame, open the basic noise reduction and configure the class of basic noise reduction. The higher the class, the better the noise reduction, but the image will be less clear.
Gain settings	Auto Gain	The larger the gain value, the more unstable the image.
	Balanced Gain	The larger the district, the bigger the contrast.
	Gain Mode	Low-temperature mode and high-temperature mode are contained.
FFC Settings	FFC Mode	Method of correcting the shutter. <ul style="list-style-type: none"> • Auto: According to the switch period that you have configured, the shutter will be corrected regularly. • Manual: Correct the shutter by yourself.
	FFC Period	You can configure this parameter only when FFC Mode is set to be Auto . Adjust time gap of correcting the shutter automatically.
	Do FFC	Click Do FFC to trigger the shutter correcting for this time.

Step 4 Click **Save**.



Click **Reset** and the lens properties are restored to the primary state.

4.1.1.3 Configuring Profile Management

When configuring the profile management, you can select from **Normal**, **Full Time** and **Schedule**.

Step 1 Select **Setting > Camera > Conditions > Conditions > Profile Management**.

The Profile Management interface is displayed.

Step 2 Profile management configuration:

- When **Profile Management** is set as **Normal**, the surveillance system works under normal configuration.

Figure 4-10 Common setting

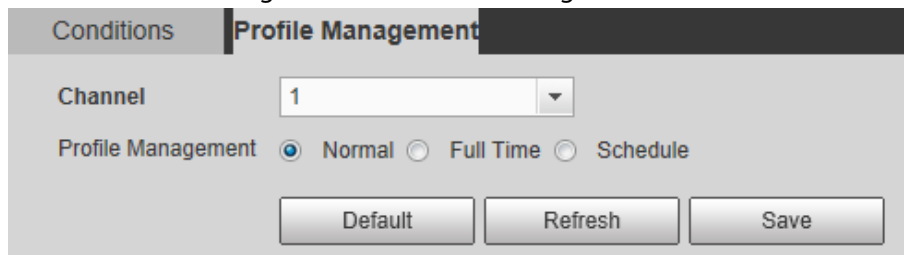

- When **Profile Management** is set as **Full Time**, you can select **Day** or **Night** as **Always Enable**, and the surveillance system works under **Always Enable**.

Figure 4-11 Full time setting

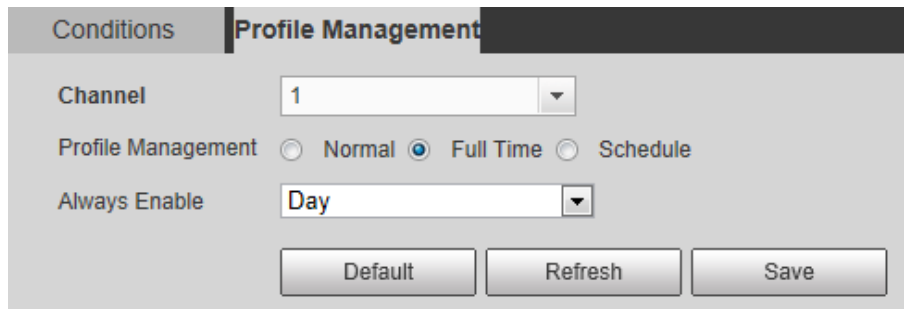

- When **Profile Management** is set as **Schedule**, you can drag the slide block to set certain time as Day or Night. For example, set 8:00–5:00 PM as day, and 0:00–8:00 and 18:00–24:00 as night. System works under corresponding configuration in different time.

Figure 4-12 Switching based on time

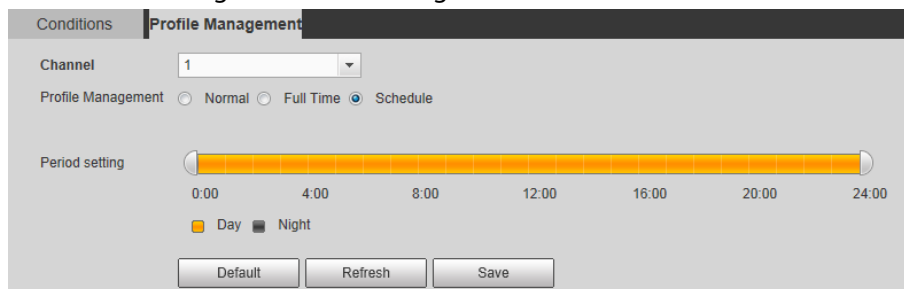

Step 3 Click **Save**.

4.1.2 Configuring Video Parameters

4.1.2.1 Configuring Video Streaming

Configure video stream parameters, including stream type, encode mode, resolution, frame rate, bit stream control, bit stream, I frame interval, SVC, and watermark.

Step 1 Select **Setting > Camera > Video > Video**.

The **Video** interface is displayed. See Figure 4-13.



The default bit stream value of different Cameras might vary, and the actual product shall prevail.

Figure 4-13 Video

The screenshot shows a video configuration interface with the following settings:

- Channel:** 1
- Main Stream:**
 - Encode Mode: H.264H
 - Resolution: 1920*1080(1080P)
 - Frame Rate(FPS): 25
 - Bit Rate Type: CBR
 - Reference Bit Rate: 1024-8192Kb/S
 - Bit Rate: 4096 (Kb/S)
 - I Frame Interval: 50 (25-150)
 - SVC: 1(off)
 - Watermark Settings: Watermark Character: DigitalCCTV
- Sub Stream:**
 - Enable
 - Encode Mode: H.264H
 - Resolution: 352*288(CIF)
 - Frame Rate(FPS): 15
 - Bit Rate Type: CBR
 - Reference Bit Rate: 32-640Kb/S
 - Bit Rate: 192 (Kb/S)
 - I Frame Interval: 30 (15-150)
 - SVC: 1(off)

Buttons at the bottom: Default, Refresh, Save.

Step 2 Configure video streaming. See Table 4-9.

Table 4-9 Parameter description

Parameter	Description
Enable	Select the option box to enable sub stream (enabled by default). Enabling sub stream 1 and sub stream 2 at the same time are supported.
Encode Mode	Encode mode of video. <ul style="list-style-type: none"> ● H.264: Main profile encode mode. ● H.264H: High profile encode mode. ● H.264B: Baseline profile encode mode. ● MJPEG: Under this mode, the higher streaming value is required to ensure the clarity of images. And, we suggest that you should use the maximum streaming value we have offered.
Resolution	The resolution of the video The max resolution of different Cameras might vary, and the actual product shall prevail.
Frame Rate (FPS)	The number of frame in one second of video The higher the FPS is, the clearer and smoother the video will be.
Bit rate	You can select bit rate type: <ul style="list-style-type: none"> ● Fixed: the bit rate changes little and keeps close to the set bit rate value. ● Changeable: the bit rate changes as monitoring scene changes.  <p>Bit rate type can only be set as Fixed when Encode Mode is set as MJPEG.</p>
Image quality	This parameter can be configured only when the bit rate type is set as "Changeable." Image quality can be classified as the six levels of "the best", "the better", "good", "bad", "the worse", "the worst."
Reference bit rate value	According to resolution and frame rate you have set, we have offered you a reference bit rate value, which is also the best value you can adopt.
Bit rate	This parameter can be configured only when the bit rate type is set as Fixed . If you select the bit rate value according to "reference bit rate value", the streaming changes little and keeps close to the bit rate value you have selected. Select Customized and you can configure bit rate value manually.

Maximum bit rate	This parameter can be configured only when bit rate type is set as Changeable . You can select the max value of the bit rate according to the reference bit rate value, and the bit rate changes with monitoring scenes, but the max bit rate keeps close to the value you set.
I Frame Interval	The number of P frame between two I frames, and the I Frame Interval range changes as FPS. It is recommended to set I Frame Interval twice as big as FPS.
SVC	Scaled video coding, able to encode a high quality video bit stream that contains one or more subset bit streams. The default value is 1, which means no layered coding.
Watermark Settings	Select the check box to enable watermark. Then you can check if the video has been tampered by verifying the watermark.
Watermark character	The default character is Digital CCTV.  You can configure at most 128 watermark characters which are composed of number, letter, underline and dash.

Step 3 Click **Save**.

4.1.2.2 Configuring Image Streaming

Configure parameters of image streaming which cover snapshot type/interval, image size/quality.

Step 1 Select **Setting > Camera > Video > Snapshot**.

The **Snapshot** interface is displayed. See Figure 4-14.

Figure 4-14 Snapshot

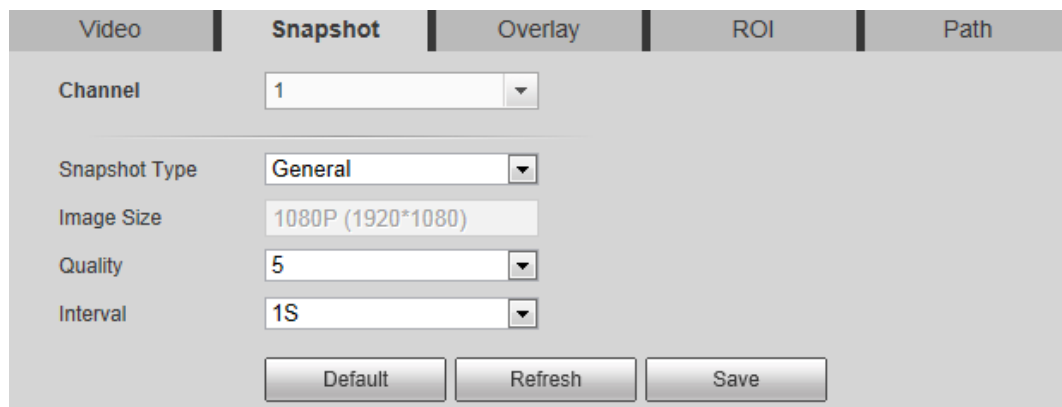

Step 2 Configure snapshot streaming. See Table 4-10.

Table 4-10 Parameter description

Parameter	Description
Snapshot type	You can select General or Event . <ul style="list-style-type: none"> General means the system takes snapshot as scheduled Event means snapshot functions when video/audio detection, event or alarm is triggered.
Image Size	The same resolution with main stream.
Quality	Snapshot quality. The bigger the value, the better the snapshot quality.
Snapshot interval	Snapshot frequency. Select Customized to manually configure snapshot frequency.

Heat map in jpeg	Select the check box and snapshots of thermal images will carry the temperature-measuring information.
------------------	--

Step 3 Click **Save**.

4.1.2.3 Configuring Video Overlay

Configure **Overlay** which covers **Privacy Masking**, **Channel Title**, **Time Title**, **Geography location**, **Font**, and **Picture Overlay**.

4.1.2.3.1 Configuring Privacy Masking

You can enable this function if you need to cover certain area in the video image.



This function is available only for bullet cameras.

Step 1 Select **Setting > Camera > Video > Overlay**.

The **Overlay** interface is displayed.

Step 2 Click **Privacy Masking**.

The **Privacy Masking** interface is displayed. See Figure 4-15.

Figure 4-15 Privacy masking interface

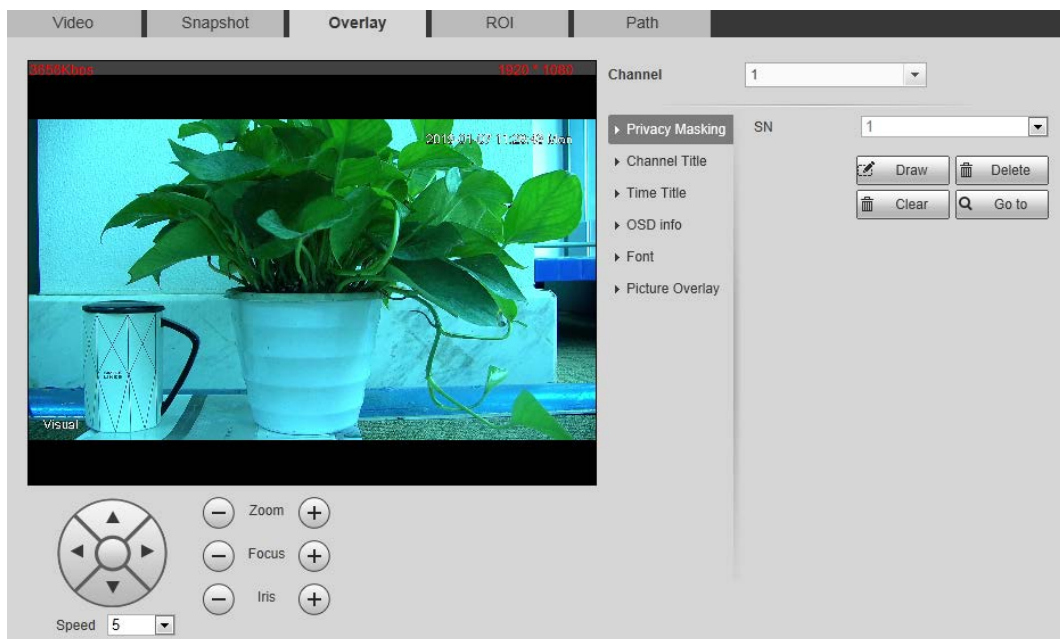

Step 3 Select **Enable**, and then drag the block to the area that you need to cover.



- You can draw four area boxes at most.
- Click **Remove All** to delete all the area boxes; you can also just select one box, and click **Delete** or right-click to delete it.

Step 4 Click **Save**.

4.1.2.3.2 Configuring Channel Title

You can enable this function if you need to display Channel title in the video image.

Step 1 Select **Setting > Camera > video > Overlay**.

The **Overlay** interface is displayed.

Step 2 Click **Channel Title**.

The **Channel Title** interface is displayed. See Figure 4-16.

Figure 4-16 Channel title

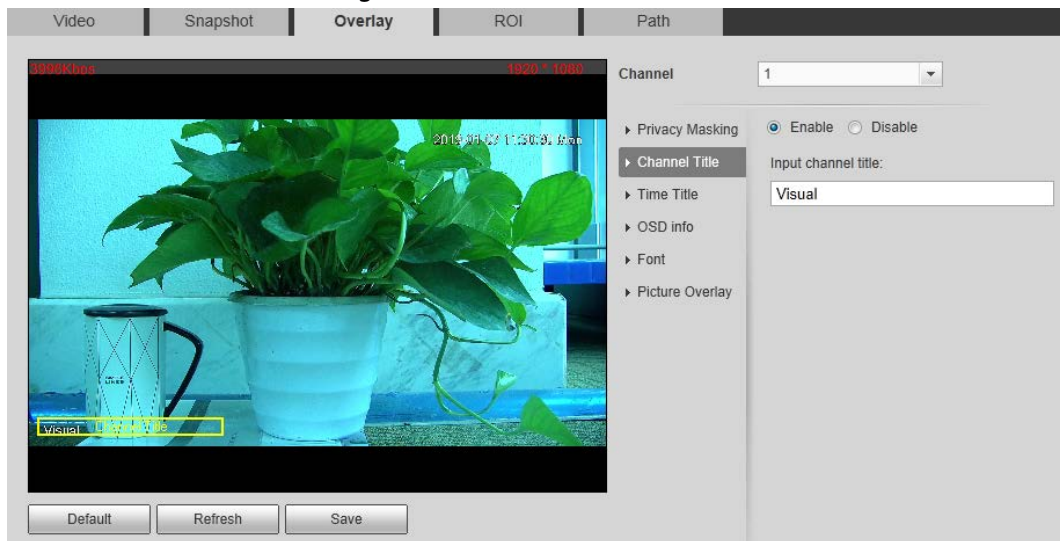

Step 3 Select **Enable** and enter channel title, and then the title displays in the video image.



You can drag the "Channel Title" box in the video image with your mouse to adjust the box's location.

Step 4 Click **Save**.

4.1.2.3.3 Configuring Time Title

You can enable this function if you need to display time on the video image.

Step 1 Select **Setting > Camera > Video > Overlay**.

The **Overlay** interface is displayed.

Step 2 Click **Time Title**.

The **Time Title** interface is displayed. See Figure 4-17.

Figure 4-17 Time title



Step 3 Select the **Enable** check box, and the time displays in the video image.

Step 4 Click **Week Display**, and then the week information displays in the video image.



You can drag the "Time Title" box in the video image with your mouse to adjust the box's location.

Step 5 Click **Save**.

4.1.2.3.4 Configuring OSD Info

Enable this function if you want to display words on the video image.



- **Text Overlay** and **Picture Overlay** can't work at the same time.
- This function is available on select models and the actual interface shall prevail.

Step 1 Select **Setting > Camera > Video > Overlay**.

The **Overlay** interface is displayed.

Step 2 Click **OSD Info**.

The **OSD Info** interface is displayed. See Figure 4-18.

Figure 4-18 OSD Info

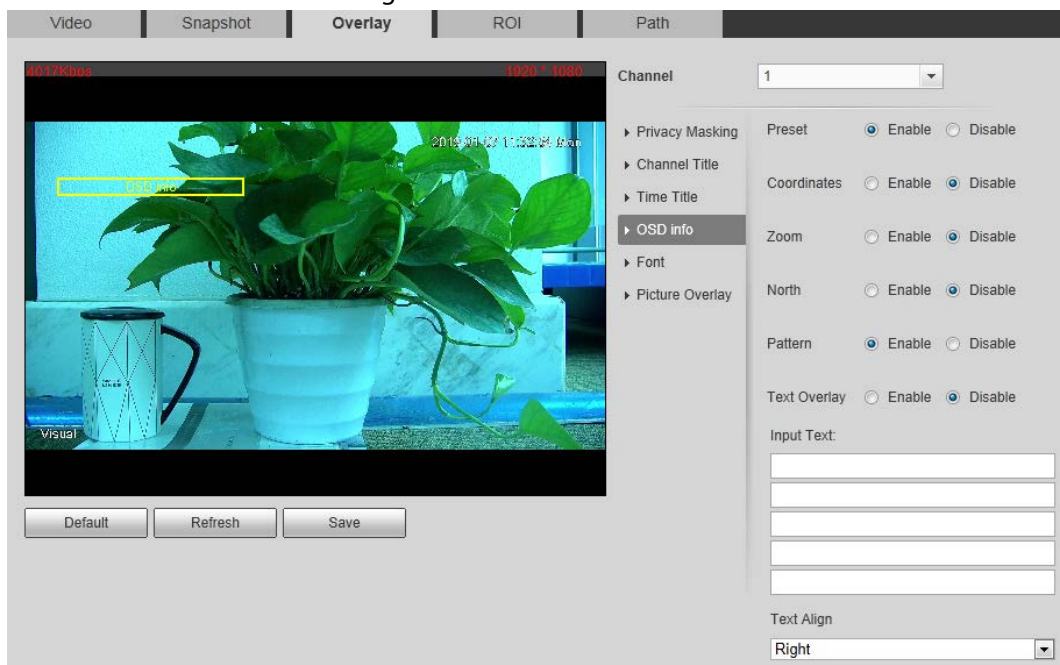

Step 3 Select the **Enable** check box of **Text Overlay**, and enter text based on your own needs. Then, select the text align method, and the **OSD Info** box is displayed on the video image.



You can drag the **OSD Info** box on the video image with your mouse to adjust the box's location.

Step 4 Click **Save**.

4.1.2.3.5 Configuring Font

You can adjust size and color of the font in the video images based on your own needs.

Step 1 Select **Setting > Camera > video > Overlay**.

The **Overlay** interface is displayed.

Step 2 Click the **Font** tab.

The **Font** interface is displayed. See Figure 4-19.

Figure 4-19 Font setting

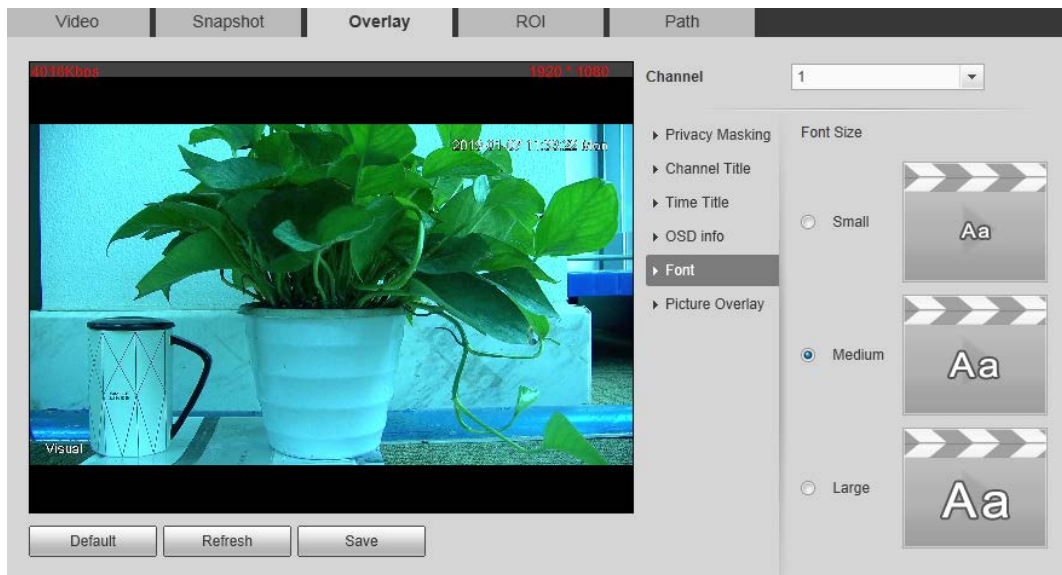

Step 3 Select color and size of the font based on your own needs.

Step 4 Click **Save**.

4.1.2.3.6 Configuring Picture Overlay

You can enable this function if you need to display picture information in the video image.



Geography location and Picture overlay can't work at the same time.

Step 1 Select **Setting > Camera > video > Overlay**.

The **Overlay** interface is displayed.

Step 2 Click the **Picture Overlay** tab.

The **Picture Overlay** interface is displayed. See Figure 4-20.

Figure 4-20 Picture overlay interface

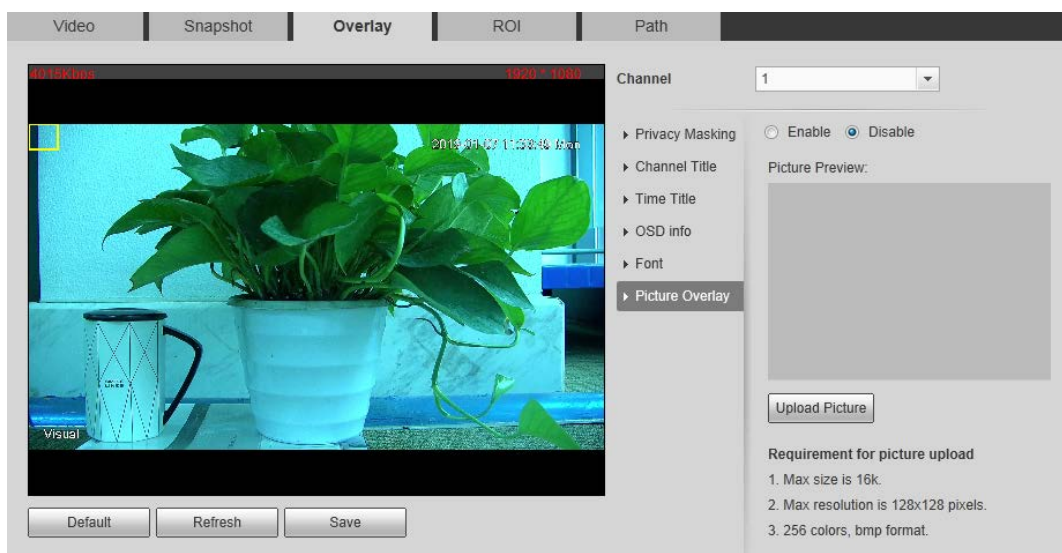

Step 3 Select the **Enable** check box.

You will be informed that OSD information is to be closed. Click **Save**.

Step 4 Click **Upload Picture**, and select a picture. The picture is displayed in video images.



You can drag the "Picture Overlay" box in the video image with your mouse to adjust the box's location.

Step 5 Click **Save**.

4.1.2.4 Configuring ROI

Select ROI in the image, and then the selected image would display with configured quality.

Step 1 Select **Setting > Camera > Video > ROI**.

The **ROI** interface is displayed. See Figure 4-21.

Figure 4-21 ROI interface

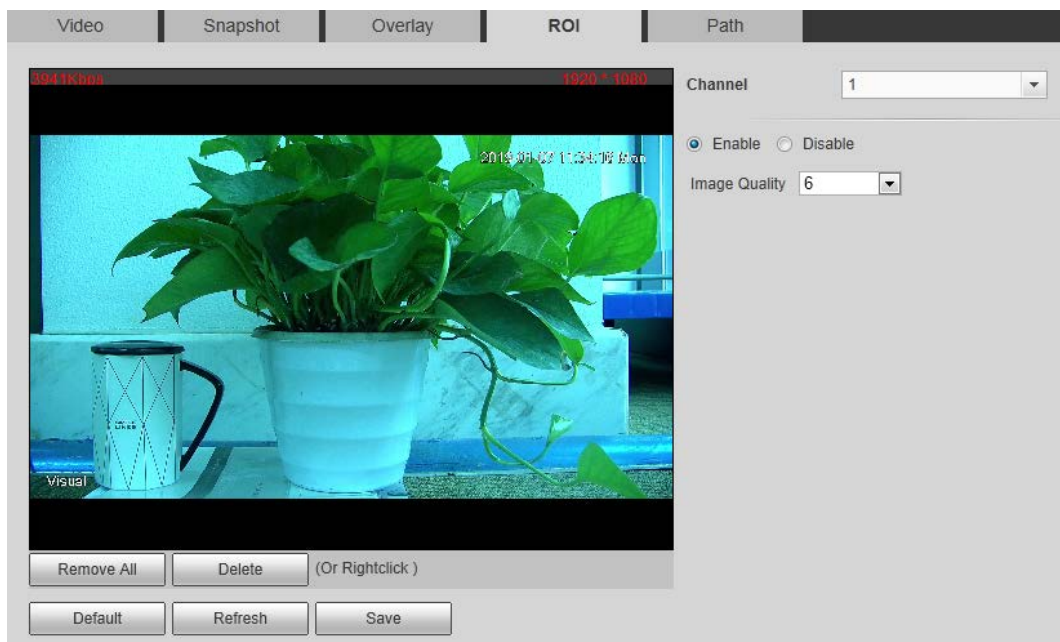

Step 2 Select the **Enable** check box.

Step 3 Hold the left mouse button to draw a ROI area on video images. You can also configure the ROI's display quality.



- You can draw at most four ROI areas.
- Click **Remove All** to delete all the area boxes; you can also just select one box, and click **Delete** or right-click to delete it.

Step 4 Click **Save**.

4.1.2.5 Configuring Storage Path

Configure storage paths covering **Live Snapshot**, **Live Record**, **Playback Snapshot**, **Playback Download**, **Video Clips**, and **Heat Map**.

Step 1 Select **Setting > Camera > Video > Path**.

The **Path** interface is displayed. See Figure 4-22.

Figure 4-22 Storage path interface

Video	Snapshot	Overlay	ROI	Path
Live Snapshot	C:\Users			Browse...
Live Record	C:\Users			Browse...
Playback Snapshot	C:\Users			Browse...
Playback Download	C:\Users			Browse...
Video Clips	C:\Users			Browse...
Heat Map	C:\Users			Browse...
		Default	Save	

Step 2 Click **Browse**, and configure storage paths of live snapshot, live record, playback snapshot, playback download, video clips, and heat map. See Table 4-11 for detailed description.

Table 4-11 Storage path description

Path	Description
Live Snapshot	Live snapshot refers to the snapshot of live interface. C:\Users\admin\WebDownload\LiveSnapshot is the default path.
Live Record	Live record refers to the recorded video of live interface. C:\Users\admin\WebDownload\LiveSnapshot is the default path.
Playback Snapshot	Playback snapshot refers to the snapshot of playback interface. C:\Users\admin\WebDownload\LiveSnapshot is the default path.
Playback Download	Playback download refers to the downloaded video of playback interface. C:\Users\admin\WebDownload\LiveSnapshot is the default path.
Video Clips	Video clips refer to the clipped video of playback interface. C:\Users\admin\WebDownload\LiveSnapshot is the default path.
Heat Map	Heat map comes from the location Setting > Temperature . C:\Users\admin\WebDownload\LiveSnapshot is the default path.



Administrator in the default path is the user account.

Step 3 Click **Save**.

4.1.3 Configuring Audio Parameters

Configure audio parameters covering **Encode Mode**, **Sampling Frequency**, **Audio in Type**, and **Noise Filter**.



Functions of different Cameras might vary and the actual product shall prevail.



Step 1 Select **Setting > Camera > Audio**.

The **Audio** interface is displayed. See Figure 4-23.

Figure 4-23 Audio

Step 2 Configure Audio parameters. See Table 4-12.

Table 4-12 Parameters

Parameters	Description
Enable	Audio can be enabled only when video is enabled. Enable Main Stream or Sub Stream , and the network stream is composed of both audio and video streams. If you do not select Main Stream or Sub Stream , then only video images are transmitted.
Encode Mode	You can select audio encode mode. G.711A, G.711Mu, and AAC are included. The configured audio encode mode applies to audio and intercom.
Sampling Frequency	Audio's sampling frequency. 8K and 16K are included.
Audio in Type	Two audio types are selectable. <ul style="list-style-type: none"> ● Linein: External audio input source is required. ● Mic: External audio input source is not required.
Noise Filter	Enable this function, and the system auto filters ambient Noise.
Microphone Volume	Adjusts microphone volume.  This function is not available for all Cameras.
Speaker Volume	Adjusts speaker volume.  This function is not available for all Cameras.

Step 3 Click **Save**.

4.2 Configuring Network

4.2.1 Configuring TCP/IP

You need to configure the camera's IP address and DNS server to connect the camera with other Cameras in the network.

Preparation

You have connected the camera to network.

Procedure

Step 1 Select **Setting > Network > TCP/IP**.

The **TCP/IP** interface is displayed. See Figure 4-24.

Figure 4-24 TCP/IP interface

TCP/IP

Host Name: TPCDome

Ethernet Card: Wire(Default)

Mode: Static DHCP

MAC Address: 20 . 18 . 06 . 30 . 13 . 55

IP Version: IPv4

IP Address: 192 . 168 . 102 . 122

Subnet Mask: 255 . 255 . 0 . 0

Default Gateway: 192 . 168 . 0 . 1

Preferred DNS: 223 . 5 . 5 . 5

Alternate DNS: 223 . 6 . 6 . 6



Enable ARP/Ping to set IP address service

Default Refresh Save

Step 2 Configure TCP/IP parameters. See Table 4-13.

Table 4-13 TCP/IP parameters

Parameter	Description
Host Name	Enter host name, 15 characters at most.
Ethernet Card	Wire (Default) is set by default.

Mode	<ul style="list-style-type: none"> • Static: You need to manually configure IP Address, Subnet Mask and Default Gateway. • DHCP: Obtains IP address automatically. With DHCP enabled, IP Address, Subnet Mask and Default Gateway cannot be configured. You can check the current IP address whether the DHCP takes effect or not. 	
MAC Address	Host's MAC address, cannot be modified.	
IP Version	Select IPv4 or IPv6.	
IP Address	<p>You can type IP address and subnet mask according to your own needs.</p>  <p>All the IPv6 addresses will be validated, so ensure IP address and subnet mask are in the same network segment, which means the front parts of the IP address and the default gateway are the same one.</p>	
Subnet Mask		
Default Gateway	Configure as needed, the default gateway must be in the same network segment with the IP address.	 <p>There is no default gateway for IPv6. Enter 128 digits in preferred DNS and alternate DNS.</p>
Preferred DNS	IP address of the preferred DNS.	
Alternate DNS	IP address of the alternate DNS.	

<p>Enable ARP/Ping to set IP address service.</p>	<p>Select the check box, get the Camera MAC address, and then you can modify and configure the Camera IP address with ARP/ping command.</p> <p>This is enabled by default. During reboot, you will have no more than two minutes to configure the Camera IP address with a ping packet which has certain length. The server will be turned off in 2 minutes, or it will be turned off immediately after IP address configuration. If this is not enabled, the IP address cannot be configured with ping packet.</p> <p>A demonstration of configuring IP address with ARP/Ping.</p> <ol style="list-style-type: none"> To obtain a free IP address, you need to ensure that the Camera and your PC are in the same LAN. Get MAC address from the Camera label. Open command editor on your PC and enter the following command. <table border="1" data-bbox="576 645 1241 1200"> <tr> <td>Windows syntax</td> </tr> <tr> <td><code>arp -s <IP Address> <MAC> ↵</code> <code>ping -l 480 -t <IP Address> ↵</code></td> </tr> <tr> <td>Windows example</td> </tr> <tr> <td><code>arp -s 192.168.0.125 11-40-8c-18-10-11 ↵</code> <code>ping -l 480 -t 192.168.0.125 ↵</code></td> </tr> <tr> <td>UNIX/Linux/Mac syntax</td> </tr> <tr> <td><code>arp -s <IP Address> <MAC> ↵</code> <code>ping -s 480 <IP Address> ↵</code></td> </tr> <tr> <td>UNIX/Linux/Mac example</td> </tr> <tr> <td><code>arp -s 192.168.0.125 11-40-8c-18-10-11 ↵</code> <code>ping -s 480 192.168.0.125 ↵</code></td> </tr> </table> Reboot through power or network. Check your PC command line. If there is information such as "Reply from 192.168.0.125...", you have done configuration successfully. Turn it off then. Enter http://(IP address) in the browser address bar to log in. 	Windows syntax	<code>arp -s <IP Address> <MAC> ↵</code> <code>ping -l 480 -t <IP Address> ↵</code>	Windows example	<code>arp -s 192.168.0.125 11-40-8c-18-10-11 ↵</code> <code>ping -l 480 -t 192.168.0.125 ↵</code>	UNIX/Linux/Mac syntax	<code>arp -s <IP Address> <MAC> ↵</code> <code>ping -s 480 <IP Address> ↵</code>	UNIX/Linux/Mac example	<code>arp -s 192.168.0.125 11-40-8c-18-10-11 ↵</code> <code>ping -s 480 192.168.0.125 ↵</code>
	Windows syntax								
<code>arp -s <IP Address> <MAC> ↵</code> <code>ping -l 480 -t <IP Address> ↵</code>									
Windows example									
<code>arp -s 192.168.0.125 11-40-8c-18-10-11 ↵</code> <code>ping -l 480 -t 192.168.0.125 ↵</code>									
UNIX/Linux/Mac syntax									
<code>arp -s <IP Address> <MAC> ↵</code> <code>ping -s 480 <IP Address> ↵</code>									
UNIX/Linux/Mac example									
<code>arp -s 192.168.0.125 11-40-8c-18-10-11 ↵</code> <code>ping -s 480 192.168.0.125 ↵</code>									

Step 3 Click **Save**.

4.2.2 Configuring Port

4.2.2.1 Configuring Port Parameters

You can configure the maximum port number and each port value.

Step 1 Select **Setting > Network > Port > Port**.

The **Port** interface is displayed. See Figure 4-25.

Figure 4-25 Port

The screenshot shows a configuration window titled 'Port' with a sub-tab 'ONVIF'. It contains the following fields and controls:

- Max Connection: Input field with '10', range '(1~20)'
- TCP Port: Input field with '37777', range '(1025~65534)'
- UDP Port: Input field with '37778', range '(1025~65534)'
- HTTP Port: Input field with '80'
- RTSP Port: Input field with '554'
- HTTPS
- HTTPS Port: Input field with '443'
- Buttons: Default, Refresh, Save

Step 2 Configure parameters. See Table 4-14.



- Configuration of **Max Connection** takes effect immediately and others after reboot.
- 0–1024, 37780, 37880, 1900, 3800, 5000, 5050, 9999, 37776, 39999 and 42323 are occupied for specific uses.
- It is not recommended to use the default value of other port during port configuration.

Table 4-14 Port parameter description

Parameter	Description
Max Connection	The maximum number of users (web client, platform client or mobile phone client) that can connect to the Camera simultaneously, the value is 10 by default.
TCP Port	Port of transmission control protocol. The value is 37777 by default.
UDP Port	User datagram protocol port, the value is 37778 by default.
HTTP Port	HTTP communication port. The default value is 80. If you have modified the default value, when logging in through a browser, you need to add the latest port number to the end of IP address.

RTSP Port	<ul style="list-style-type: none"> • 554 is the default port number. If you play live view through Apple's QuickTime or VLC, the following format is available. This function is also available for Blackberry. • When the URL format requiring RTSP, you need to specify channel number and bit stream type in the URL, and also user name and password if needed. • When playing live view with Blackberry smart phone, you need to turn off the audio, and then set the code mode to H.264B and resolution to CIF. <p>URL format example: rtsp://username:password@ip:port/cam/realmonitor?channel=1&subtype=0</p> <ul style="list-style-type: none"> • Username: admin, for example. • password • IP: your Camera IP. • Port: leave it if the value is 554 by default. • Channel 1: Channel number, starts from 1. For example, if you are using channel 2, then the channel=2. • Subtype refers to Bit stream type; 0 means main stream (Subtype=0) and 1 means sub stream (Subtype=1). <p>So, if you require the sub stream of channel 2 from a certain Camera, then the URL should be: rtsp://admin:admin@10.12.4.84:554/cam/realmonitor?channel=2&subtype=1</p> <p>If user name and password are not needed, then the URL can be: rtsp://ip:port/cam/realmonitor?channel=1&subtype=0</p>
Enable HTTPS	HTTPS: Control of communication service. After selecting the check box, you can log in the Camera through https://ip:port. When there is a default port, you can log in through https://ip.
HTTPS Port	HTTPS communication port whose value can be selected from 1025–65534 and 443 is the default value.

Step 3 Click **Save**.

4.2.2.2 Configuring ONVIF Verification When Logging

With ONVIF port standard, network video products (video recording Camera and other recording Cameras included) of different manufacturers can be connected to each other.



- ONVIF is enabled by default.
- When logging in through ONVIF, the default names of both "username" and "password" are admin and the default port value is 80.

Step 1 Select **Setting > Network > Port > ONVIF**.

The **ONVIF** interface is displayed. See Figure 4-26.

Figure 4-26 ONVIF

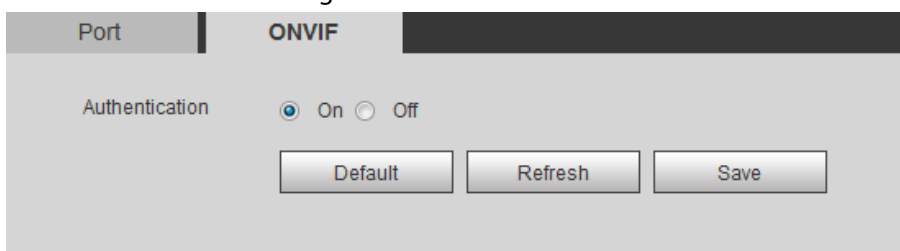

Step 2 Select the **On** check box in **Authentication** bar.

Step 3 Click **Save**.

4.2.3 Configuring PPPoE

Point-to-Point Protocol over Ethernet, it is one of the protocols that Camera uses to connect to the internet. Get the PPPoE user name and password from the Internet Service Provider, and then, set network connection through PPPoE, the Camera will acquire a WAN dynamic IP address.



- Disable UPnP while using PPPoE to avoid possible influence.
- After making PPPoE connection, the Camera IP address cannot be modified through web interface.

Step 1 Select **Setting > Network > PPPoE**.

The **PPPoE** interface is displayed. See Figure 4-27.

Figure 4-27 PPPoE

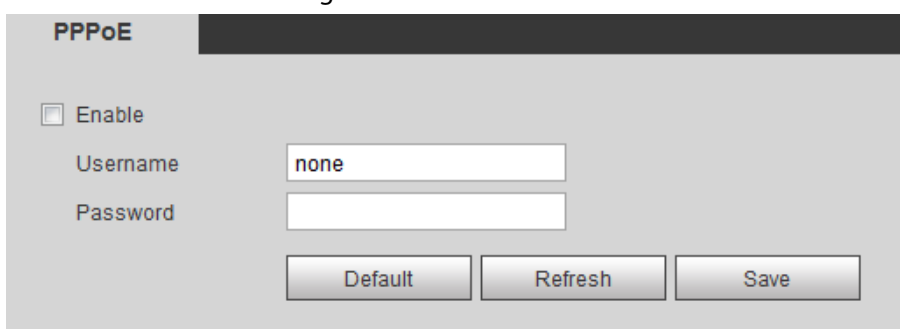

Step 2 Select the **Enable** check box, and type user name and password.

Step 3 Click **Save**.

The successful prompt displays, and then the real-time WAN IP address is displayed. You can visit Camera through this IP address.

4.2.4 Configuring DDNS

When Camera's IP address is frequently changed, you can enable DDNS to dynamically update the relation between domain name and IP address (both of which are in the DNS server). By this, you can log in the Camera through a domain name.

Preparation

Before making any changes, check if your Camera supports the DNS server.

- If Quick DDNS is the DDNS' type, you do not need to register a new domain name.
- If Quick DDNS is not the DDNS' type, you need to log in the domain name of website registration provided by DDNS service provider.



Register and log in the DDNS website, and then you can view the information of all the connected Cameras in your account.

Procedure

Step 1 Select **Setting > Network > DDNS**.

The **DDNS** interface is displayed. See Figure 4-28.

Figure 4-28 DDNS setting interface

Step 2 Select **Type** and configure as needed.

Table 4-15 DDNS parameters

Parameter	Description
Type	See the name and web site of DDNS service provides below:
Address	<ul style="list-style-type: none"> "members.dyndns.org" is the IP address of DynDNS. "dynupdate.no-ip.com" is the IP address of NO-IP DDNS. "members.3322.org" is the IP address of CN99 DDNS.
Domain name	The domain name you registered on the DDNS website.
User name	Enter the user name and password you got from DDNS service provide. You need to register an account (with user name and password) on the DDNS service provides' website.
Password	
Update period	The update cycle of the connection between your Camera and the server. 10 minutes are set by default.

Step 3 Click **Save**.

Open your browser, and type the domain name into address bar. Press **Enter**. If a web interface is displayed, the configuration is finished successfully.

4.2.5 Configuring SMTP

Configure **SMTP (Email)**. When alarm, video detection, abnormal event and intelligent are triggered, SMTP alarms will be transmitted to the specific Emails you have configured.

Step 1 Select **Setting > Network > SMTP (Email)**.

The **SMTP (Email)** interface is displayed. See Figure 4-29.

Figure 4-29 SMTP (Email)

Step 2 Configure your SMTP server.

Step 3 For SMTP (Email)'s other parameters to be configured, see Table 4-16.

Table 4-16 SMTP (Email) parameter description

Parameter	Description
Anonymity	Enable Anonymity , and senders' identities will not be displayed in Emails transmitted to others.
Sender	Sender's email address
Encryption type	Select Authentication type from None, SSL and TLS. TLS is set by default.
Attachment	Select the check box to support attachment in the email.
Title	You can enter no more than 63 characters in Chinese, English, and numbers.
Receiver	Receiver's mail address. Supports 3 addresses at most.
Interval	Time intervals of sending alarm Emails. "0" means there is no interval. Set a time interval (normally >0s) as you want and when alarm, video detection, or event is triggered, Emails will not be transmitted all the time but be transmitted in the time interval you have set. This function is aimed at easing the pressure that is put on the Email server when there are quite a lot of abnormal events.
Health Mail	The system sends test mail to check if the connection is successfully set. Select Health Mail to configure Update Period . E-mail testing results will be transmitted in time intervals you have set.
Test	Test the email sending and receiving function. If the configuration is correct, you would receive test email. Save email configuration before running rest.

Step 4 Click **Save**.

4.2.6 Configuring UPnP

Configure UPnP protocols to establish the reflection relation between intranet and external network. A user can access IP address of external network to visit Cameras in the intranet.

Preparation

- Ensure UPnP network service has been installed to your PC.
- Log in the router, and configure WAN IP address to set internet connection.
- Enable UPnP in the router.
- Connect your Camera to the LAN port of the router.
- Set IP address of your router as that of your Camera, or select DHCP to obtain IP address automatically.

Procedure

Step 1 Select **Setting > Network > UPnP**.

The **UPnP** interface is displayed. See Figure 4-30.

Figure 4-30 UPnP

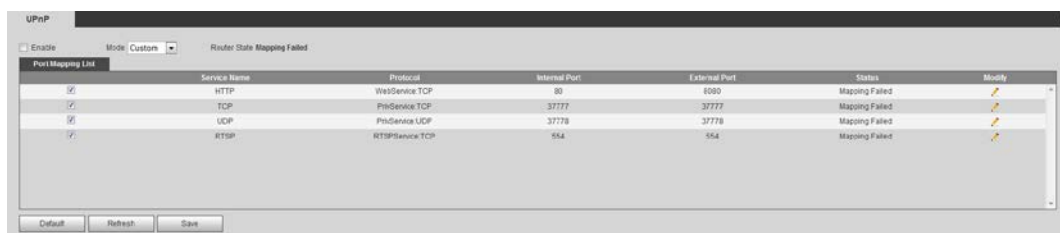

Step 2 Select the **Enable** check box.

Step 3 Select mode, and service name in the port mapping list.

UPnP can be classified as custom mode and default mode.

- Under custom mode, you can change external ports.
- Under default mode, you do not need to change ports and reflection relations.

Step 4 Click **Save**.

Type "http:// (external network IP address): (external port number)" to access Cameras in Intranet whose ports correspond to your router.

4.2.7 Configuring SNMP

SNMP (Simple Network Management Protocol) is a basic network management framework. You need to install certain software to the Camera to obtain the Camera's information.

Preparation

- Install SNMP monitoring and managing tools such as MIB Builder and MG-SOFT MIB Browser.
- You can contact technical support for the MIB file that matches the current version.

Procedure

Step 1 Select **Setting > Network > SNMP**.

The **SNMP** interface is displayed. See Figure 4-31 and Figure 4-32.

Figure 4-31 SNMP (1)

The interface shows the following configuration options:

- Version: v1, v2, v3 (Recommen...)
- SNMP Port: (1~65535)
- Read Community: **Must**
- Write Community: **Must**
- Trap Address:
- Trap Port:
- Keep Alive

Buttons: Default, Refresh, Save

Figure 4-32 SNMP (2)

The interface shows the following configuration options:

- Version: v1, v2, v3 (Recommen...)
- SNMP Port: (1~65535)
- Read Community:
- Write Community:
- Trap Address:
- Trap Port:
- Keep Alive
- Read-only Username:
- Authentication Type: MD5, SHA
- Authentication Pas...: **The minimum pass phrase length is 8 characters**
- Encryption Type: CBC-DES
- Encryption Password: **The minimum pass phrase length is 8 characters**
- Read&write Userna...:
- Authentication Type: MD5, SHA
- Authentication Pas...: **The minimum pass phrase length is 8 characters**
- Encryption Type: CBC-DES
- Encryption Password: **The minimum pass phrase length is 8 characters**



Buttons: Default, Refresh, Save

Step 2 Select the **Version** check box to enable SNMP.

Step 3 Configure SNMP parameters. See Table 4-17.

In the **Trap Address** bar, enter the IP address of the PC that has MIB Builder and MG-SOFT MIB Browser installed, other parameters leave to the default.

Table 4-17 SNMP parameter description

Parameter	Description
SNMP Version	Select a version and its information will be displayed in the SNMP interface. <ul style="list-style-type: none"> ● Select v1, and only v1's information is displayed. ● Select v2, and only v2's information is displayed. ● Select v3, and you can configure user name, password and authentication type. It requires corresponding user name, password and authentication type from the server to visit your Camera. V1 and v2 version are now unavailable.
SNMP Port	Refers to the listening port of the software agent in the Camera.
Community	A character string, acts as a clear text password which can manage network's process and agent process. It defines the relation concerning certification, access, and escrow between agent and administrator. Camera and agent must be consistent.
Read community, write community	Refers to the read and write community string that the software agent supports.  You can enter number, letter, underline and dash to form the name.
Trap	SNMP trap is a SNMP agent which transmits information such as important event or change of state to the administrator.
Trap address	A destination address to which agent program sends trap information.
Trap Port	A destination port to which agent program sends trap information. 162 set by default and range from 1-65535.
Read-only username	The name is "public" by default.  You can enter number, letter, underline to form the name.
Read/Write username	The name is "private" by default.  You can enter number, letter, underline to form the name.
Authentication type	You can select from MD5 and SHA, the default type is MD5.
Authentication password	It should be no less than 8 digits.
Encryption type	The default is CBC-DES.
Encryption Password	It should be no less than 8 digits.

Step 4 Click **Save**.

Step 5 View Camera information.

- 1) Run MIB Builder and MG-SOFT MIB Browser.
- 2) Compile the two MIB files with MIB Builder.
- 3) Load the generated modules with MG-SOFT MIB Browser.
- 4) Enter the IP address of the Camera you need to manage in the MG-SOFT MIB Browser, and then select version to search.

- 5) Unfold all the tree lists displayed in the MG-SOFT MIB Browser, and then you can view the configuration information, video channel amount, audio channel amount and software version.



Use PC with Windows OS and disable SNMP Trap service. The MG-SOFT MIB Browser will display prompt when alarm is triggered.

4.2.8 Configuring Bonjour

Bonjour is also called zero-configuration networking. With Bonjour built into Cameras such as your phone, this thermal camera can be searched and accessed. Bonjour is a protocol of industry standard which allows Cameras search and find each other. IP address or DNS server is not required during this process.

Enable Bonjour in this thermal camera, and this camera will be automatically detected by your client-side or web with Bonjour function. When this thermal camera is detected by Bonjour, server name you have set will be displayed.



Bonjour is enabled by default.

Step 1 Select **Setting > Network > Bonjour**.

The **Bonjour** interface is displayed. See Figure 4-33.

Figure 4-33 Bonjour

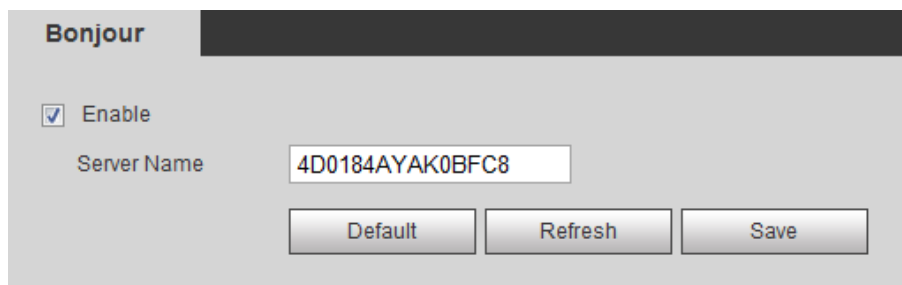

Step 2 Select the **Enable** check box, and then configure server name.

Step 3 Click **Save**.

You can use Safari browser, and your client side or web with Bonjour function to access the thermal camera's web.

Step 1 Click "Show All Bookmarks" in Safari.

Step 2 Enable Bonjour, and then, in your LAN, all the network cameras in which the "Bonjour" is enabled are displayed.

Step 3 Click to visit the corresponding Web interface.

4.2.9 Configuring Multicast

The Camera has limit towards web visitors. If several people access this Camera's web in the meantime, video images may not be represented. To solve the problem, you can set the Camera's multicast IP and adopt multicast protocol.

Step 1 Select **Setting > Network > Multicast**.

The **Multicast** interface is displayed. See Figure 4-34.

Figure 4-34 Multicast

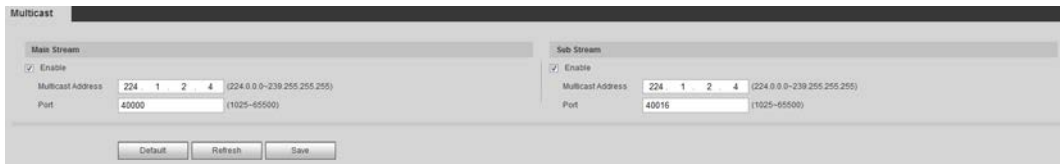

Step 2 Select **Enable** and then enter IP address and port number. See Table 4-18.

Table 4-18 Multicast

Parameter	Meaning
Description	The Multicast IP address of Main Stream/Sub Stream is 224.1.2.4 by default, and the range is 224.0.0.0–239.255.255.255.
Port	See the multicast port of corresponding stream: Main Stream: 40000; Sub Stream1: 40016; Sub Stream2: 40032, all the range is 1025–65500.

Step 3 Click **Save**, and the login interface is displayed. The configuration finishes.

In the Live interface, set **Protocol** to **Multicast**, and then you can view the video image with Multicast protocol.

4.2.10 Configuring Auto Registration

In the **Auto Register** interface, you can set an IP address to which the camera will report its location.

Step 1 Select **Setting > Network > Auto Register**.

The **Auto Register** interface is displayed. See Figure 4-35.

Figure 4-35 Auto registration

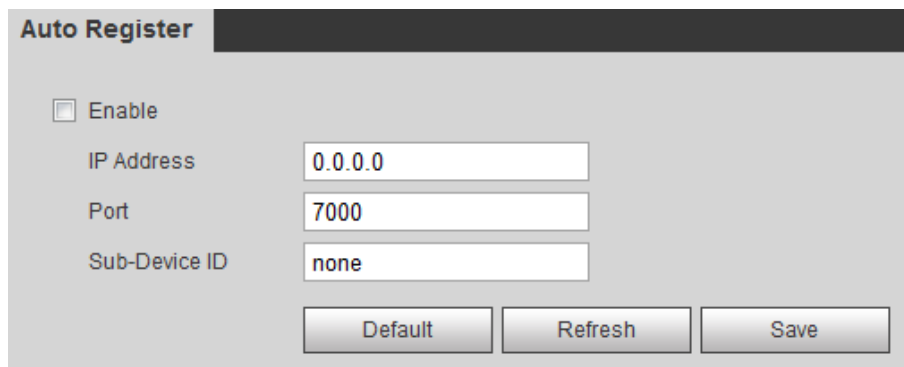

Step 2 Select the **Enable** check box.

Step 3 Set auto registration parameters. See Table 4-19.

Table 4-19 Auto registration parameter description

Parameter	Description
IP Address	IP address or domain name to which the camera transmits its location.
Port	The port for auto registration.
Sub-Camera ID	Your Camera ID given by the server.

Step 4 Click **Save**.

4.2.11 Configuring 802.1X

802.1X can control the Camera's access to LAN.

Step 1 Select **Setting > Network > 802.1x**.

The **802.1x** interface is displayed. See Figure 4-36.

Figure 4-36 802.1x

Step 2 Select the **Enable** check box.

Step 3 Set 802.1x parameters. See Table 4-20.

Table 4-20 Parameters of 802.1x

Parameter	Description
Authentication	PEAP (protected EAP protocol).
Username	The user name that was authenticated on the server.
Password	Password of your username.

Step 4 Click **Save**.

4.2.12 Configuring QoS

QoS can solve problems including network delay and congestion. It helps to assure bandwidth, reduce transmission delay, packet loss rate and delay jitter to improve service quality.

For DSCP (Differentiated Services Code Point), there are 64 priority degrees (0-63) of data packets. 0 represents the lowest and 63 the highest. Based on those differences, the 64 priority degrees will be classified as different groups. Each group occupies different bandwidth and will be abandoned accordingly. The entire configuration is to improve video quality.

Step 1 Select **Setting > Network > QoS**.

The **QoS** interface is displayed. See Figure 4-37.

Figure 4-37 QoS

Step 2 Set QoS parameters. See Table 4-21.

Table 4-21 QoS parameter description

Parameters	Description
Real-time Monitor	Priority of the data packets that are used for network surveillance.
Command	Priority degree used for the Camera's configuration and check which do not concern those surveillance data bags.

Step 3 Click **Save**.

4.3 Peripheral

Manage the Camera's components.

4.3.1 Configuring IR Light

Step 1 Select **Setting > Peripheral > IR Light**.

The **IR Light** interface is displayed. See Figure 4-38.

Figure 4-38 IR light

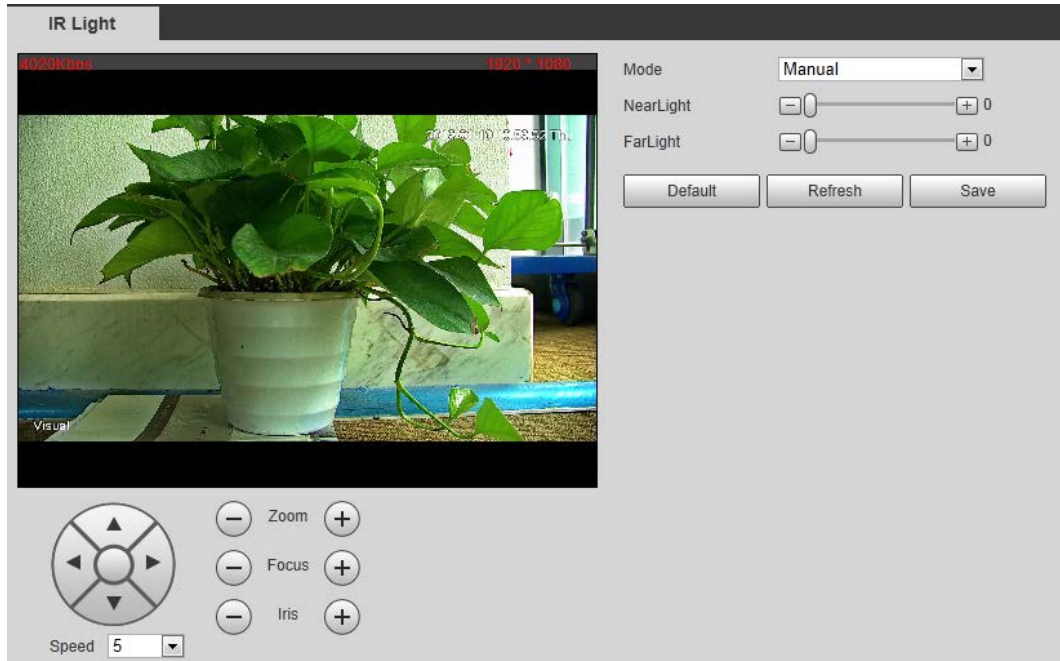

Step 2 Configure IR light's running mode.

- **Zoom Prio:** When the camera zooms in or out the visible surveillance image, the IR light's brightness will be adjusted automatically.
- **Manual:** Adjust the IR light's brightness manually to realize the best image display effect under night vision condition.

Step 3 Click **Save**.

4.3.2 Configuring Wiper

Step 1 Select **Setting > Peripheral > Wiper**.

The **Wiper** interface is displayed. See Figure 4-39.

Figure 4-39 Wiper

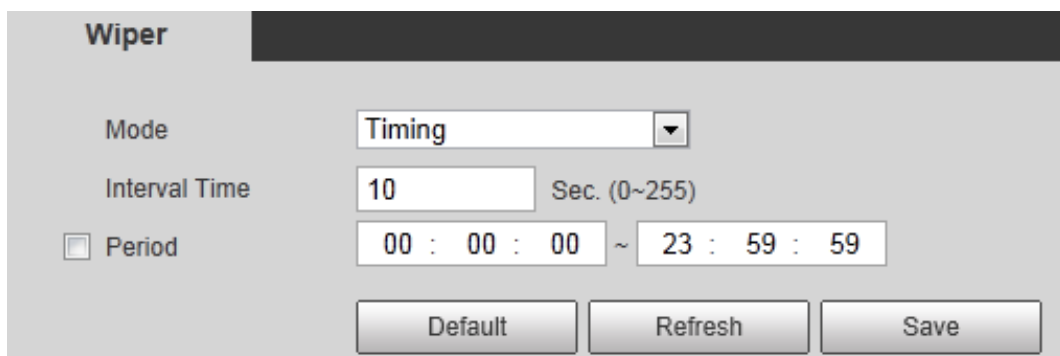

Step 2 Configure IR light's running mode.

- **Timing:** You can configure the **Interval Time** and **Period**.
 1. **Interval Time:** Interval from the point when the wiper starts to the point when the wiper stops.
 2. **Period:** Time when the wiper works.
 3. Click **Save**.
- **Manual:** Turn on and off the wiper manually.
 1. **Interval Time:** Interval from the point when the wiper starts to the point when the wiper stops.
 2. Click **Start** to get the wiper work in the interval time you have just set, and if you think the wiper has done enough work, click **Stop** to end it; Click **Once** to get the wiper work for one round.

4.3.3 Configuring Fan

Step 1 Select **Setting > Peripheral > Fan**.

The **Fan** interface is displayed. See Figure 4-40.

Figure 4-40 Fan

Step 2 Configure fan's running mode:

- **Auto:** Fan works automatically. Click **Save**.
- **Manual:** Start your fan manually. Select the **Enable** check box and click **Save**.

4.3.4 Configuring Heater

Step 1 Select **Setting > Peripheral > Heater**.

The **Heater** interface is displayed. See Figure 4-41.

Figure 4-41 Heater

Step 2 Configure heater's running mode:

- **Auto:** Select **Start Tem** and **Stop Tem** as the temperature range for heater to start, and click **Save**. When the sensor temperature is in the range, heater works automatically.

- **Manual:** When you think it's cold enough and you want to let the camera work in a warm condition, you can select **Manual** as the **Mode**. Select the **On** check box, and click **Save**.

4.4 Smart Thermal

Configure the Camera intelligent rules to help you detect objects that enter a specialized area unexpectedly and the hidden danger (fire, calling and smoking behavior in a gas station). For the five functions in Smart Thermal — Fire Warning, Smoking Detection, Call Detection, IVS and Boat Detection, you can enable only one function at a time. And, after you configure the Camera intelligent rules, you can set linked actions such as Relay-out, Send Email, PTZ, Record and Snapshot to warn suspicious people & vehicles and inform you to take measures. For linked action settings, see "4.4.10 Configure Linked Measures."



Pan & Tilt cameras and dome cameras have preset function. Bullet cameras don't. So whether the interface has preset function varies.

4.4.1 Configuring Smart Plan

You need to enable smart plan before intelligent rules function.

Step 1 Select **Setting > Event > Smart Plan**.

The **Smart Plan** interface is displayed. See Figure 4-42.

Figure 4-42 Smart Plan

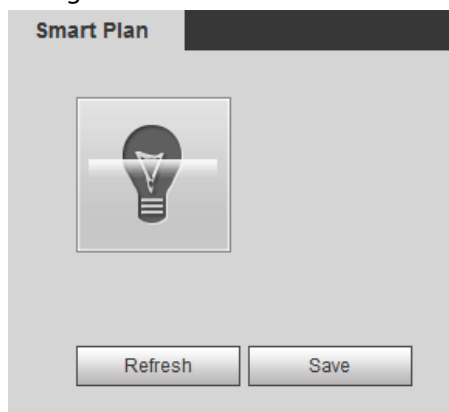

Step 2 Select a preset in **Add Plan**.

A solution corresponding to presets is displayed.



You need this step only when presets are supported in your Camera.

Step 3 Click the icon in the **Smart Plan** interface.



- The icon you have selected will be lighted.
- Click the icon again to cancel the smart plan.

Step 4 Click **Save**.

4.4.2 Configuring Intelligent Video Surveillance (IVS)

Configure intelligent rules to actively monitor objects that unexpectedly appear in the drawn area on the video image and inform you to take measures. Or, configure intelligent rules to actively monitor

objects that are valuable to you, (your car, for example), and once the objects are missing from the drawn area, linked actions, (an alarm to a thief, for example), will be triggered and you will be informed to take measures.

4.4.2.1 Basic Scene-Selecting Requirements

- The target should occupy no more than 10% of the whole image.
- The pixel of the target should be no less than 10×10; the pixel of abandoned object should be no less than 15×15 (CIF image); the width and height of the target should be no more than 1/3 that of the image; it is recommended that the height of the target should be set to 10% of the image height.
- The brightness difference of the target and the background should be no less than 10 gray levels.
- The target should be continuously present in the image for no less than 2 seconds, and the moving distance should be larger its width and no less than 15 pixels (CIF image) at the same time.
- Try to reduce the scene complexity as much as condition allowed; it is not recommended to use Intelligence Behavior Analysis in scenes with intensive targets, changing lighting conditions or small difference between target temperature and scene temperature.
- For thermal channel, try not to monitor scenes with glass. For visual channel, try not to monitor: scenes with reflective surfaces such as glass, bright ground or water; scenes that disturbed by tree branches, shadows or winged insects; scenes that against light or under direct light exposure. Control image proportion of objects that are with high relative ambient temperature.

4.4.2.2 Configuring Intelligent Rules

See Table 4-22 for rules available for thermal and visual channels.

Table 4-22 Rules available

Channel	Tripwire	Intrusion	Abandoned Object	Missing Object
Thermal (channel 2)	Yes	Yes	No	No
Visual (channel 1)	Yes	Yes	Yes	Yes

Configure Smart Plan

Select a preset for which you can enable the intelligent rules (tripwire, intrusion, abandoned object or missing object) first. Then you can configure detailed settings.

Go to the **Live** interface and select **Preset** in **PTZ function** box. Then select a preset number and

click  to examine whether or not it's the scene where you want to set intelligent rules. See Figure 4-49. If not, go to **Setting > PTZ > Function > Preset** to add a new preset.





Figure 4-43 PTZ function

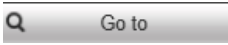
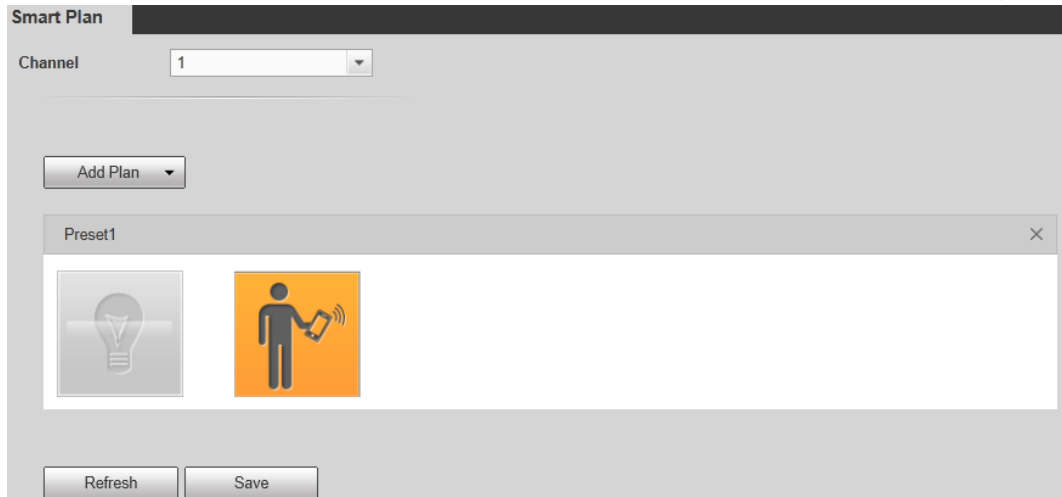

Step 1 Select **Setting > Smart Thermal > Smart Plan**. The **Smart Plan** interface is displayed.



Step 2 Select **1** or **2** in **Channel** box and click **Add Plan** to select a preset.

Step 3 You might see IVS icon is , which means IVS function is enabled. If IVS icon is , you might need to click other icons, , for example, to disable other functions and click  to enable it.

Step 4 Click **Save**.

Auto Tracking

For intelligent rules, you can set their linked measures such as Audio Linkage, White Light and Relay-out. Auto Tracking is one of them. For example, when the rule tripwire detects an object, alarm will be triggered.

4.4.2.2.1 Tripwire

Draw a line on the video image and set a moving direction in which an object is going to cross the line. Then when the line is crossed, linked measures, (an alarm to the suspicious objects, for example), will be triggered.

Procedure

Step 1 Select **Setting > Smart Thermal > IVS**.

The **Rule Config** interface is displayed.

Step 2 Intelligent rules are set separately for thermal channel and visual channel. Decide the channel and select it in the **Channel** selection bar.

Step 3 Select a preset.

The camera turns to the spot.

Step 4 Set tripwire rules.

- 1) Click **+** to add a rule. **Tripwire** is the default **Rule Type**. In the **Name** column, double-click a name, **Rule1**, for example, to define it ("First-class guarding area" as the new name, for example). See Figure 4-44.

Figure 4-44 Tripwire

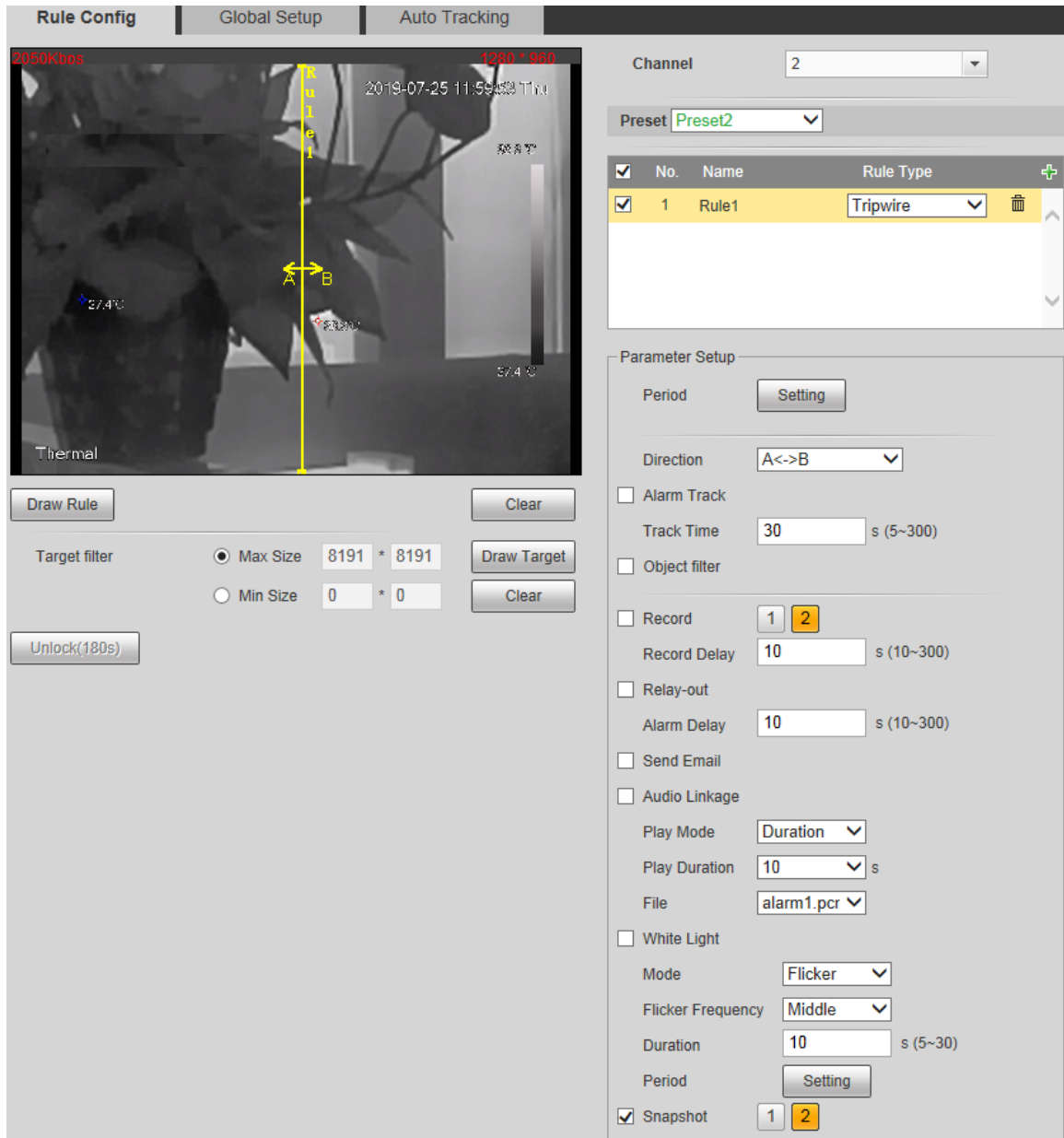

- 2) There is a default yellow line on the video image which you can click and drag towards the left or the right. However, for many cases, you might need to click **Clear** to clear the default line and click **Draw Rule** to define lines:
Draw a line (or several connected lines) and decide its extending direction and length based on the scene you want to monitor. For example, to monitor objects that are going to cross the gate, draw a line that is several meters away from the gate and parallel to the gate. And, for the rule tripwire to work out, it takes time for the Camera to detect moving objects first. So, don't draw a line near the shelters. Right-click to end drawing.
- 3) Select **Maximum Size** or **Minimum Size** and click **Draw Target**. Then you can drag the filter box's corner to make the box larger or smaller.



- An alarm is triggered only when size of the target that is crossing tripwire lies between the two filter boxes.
- When drawing a rule, you can select **Maximum Size** or **Minimum Size** and click **Clear** to delete a relevant filter box.

4) For more tripwire settings, see the following table.

Table 4-23 More tripwire settings

Parameter	Description
Direction	Configure the target moving direction for tripwire alarm, you can select A->B, B->A and A<->B.
Alarm Track	Enable this function and when tripwire is triggered, the Camera will use thermal lens or visual lens to track the object.
Track Time	Time for the lens to track the object.

Step 5 To set linked measures such as Audio Linkage and White Light when the tripwire rule detects an object, see "4.4.10 Configure Linked Measures."

Step 6 Click **Save**.

4.4.2.2.2 Intrusion

When a target is crossing or appears in the area you have set, an alarm is triggered.

Procedure

Step 1 Select **Setting > Smart Thermal > IVS**.

The **Rule Config** interface is displayed.

Step 2 Intelligent rules are set separately for thermal channel and visual channel. Decide the channel and select it in the **Channel** selection bar.

Step 3 Select a preset in **Preset** bar.

The camera turns to the position.

Step 4 Set intrusion rules.

- 1) Click  to add a rule. In the **Rule Type** column list, select **Intrusion**. In the **Name** column, double-click a name, **Rule2**, for example, to define it. See Figure 4-45.

Figure 4-45 Intrusion



- 2) There is a default yellow box on the video image which you can click and drag to the wanted area. Also, you can click the box corners to adjust the box shape. However, for many cases, you might need to click **Clear** to clear the default box and click **Draw Rule** to define box:

Based on the scene you want to monitor (a pentagon area, for example), draw a pentagon around the area. Draw a line (parallel to the pentagon area's one edge) to form the pentagon's one edge. Then along another direction and draw the second line to form the pentagon's another edge... Continue until you have finished drawing the pentagon. Right-click to end drawing. Note that for the rule tripwire to work out, it takes time for the Camera to detect moving objects first. So, don't draw a line near the shelters.

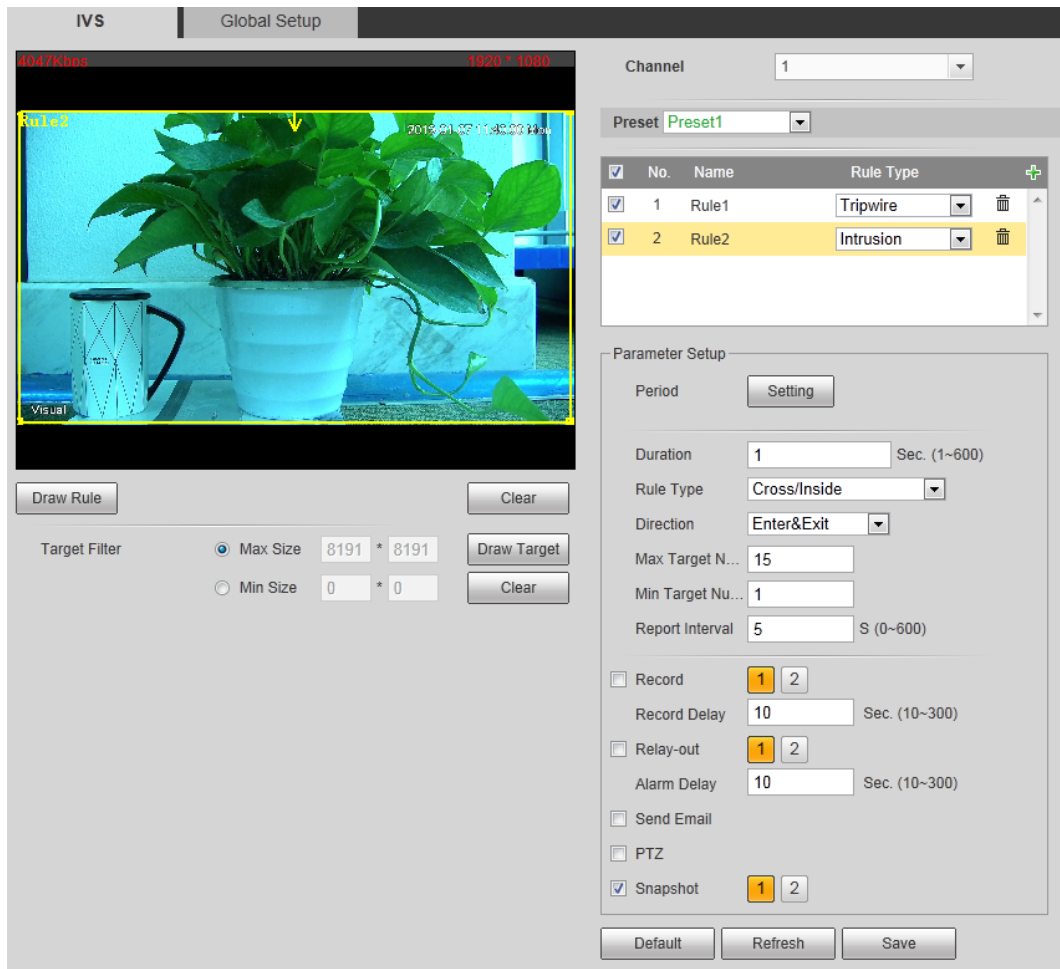
- 3) Select **Maximum Size** or **Minimum Size** and click **Draw Target**. Then you can drag the filter box's corner to make the box larger or smaller.



- An alarm is triggered only when size of target that is crossing your monitoring area lies between the two filter boxes.
- When drawing a rule, you can select **Maximum Size** or **Minimum Size** and click **Clear** to delete a relevant filter box.

- 4) Set intrusion parameters. See Table 4-24.

Table 4-24 Intrusion parameters

Parameter	Description
Period	<p>Define a period during which the alarm settings are active.</p> <ol style="list-style-type: none"> Click Setting, and the period setting interface is displayed. Configure period. <ul style="list-style-type: none"> Method 1: Hold down and drag the left mouse button to select a period you need. Method 2: Select Setting > Event > Video Detection and click Setting on the right side of Period. An interface is displayed. In this interface, there are seven Settings altogether each of which corresponds to a day in a week. Select a Setting you want and there are six periods (period1-period6) below for you to pick up. Click Save of period.
Duration	The shortest time from placing an object in the detection area to an alarm is triggered.
Rule Type	<p>Set area intrusion rules.</p> <ul style="list-style-type: none"> Cross : An alarm is triggered when an object is entering or leaving the area. Inside : An alarm is triggered when an object appears in the area. Cross/Inside: An alarm is triggered when an object is entering, leaving or appears in the area.
Direction	Set this parameter when you select Cross or Cross/Inside as your Rule Type . You can select from Enters, Exits and Enters & Exits .
Max Target Number	<p>Set this parameter when you select Inside or Cross/Inside as your Rule Type.</p> <p>Set a maximum target number and when targets' number in your area is larger than the number you have set, an alarm is frozen and does Not function.</p>
Min Target Number	<p>Set this parameter when you select Inside or Cross/Inside as your Rule Type.</p> <p>Set a minimum target number and when targets' number in your area is smaller than the number you have set, an alarm is frozen and does Not function.</p>
Report Interval	<p>Set this parameter when you select Inside or Cross/Inside as your Rule Type.</p> <p>Set the shortest time between a target appears and an alarm is triggered.</p>
Alarm Track	Enable this function and when tripwire is triggered, the Camera will use thermal lens or visual lens to track the object.
Track Time	Time for the lens to track the object.

Step 5 To set linked measures such as Audio Linkage and White Light when the rule box detects an object, see "4.4.10 Configure Linked Measures."

Step 6 Click **Save**.

4.4.2.2.3 Abandoned Object

When the object is placed in the detection area longer than the defined period, the system activates alarms and links the configured actions.

Procedure

Step 1 Select **Setting > Smart Thermal > IVS**.

The **Rule Config** interface is displayed.

Step 2 Select a preset in **Preset** bar.

The camera turns to the position.

Step 3 Configure rules.

- 1) Click  to add a rule. In the **Rule Type** column list, select **Abandoned Object**. In the **Name** column, double-click a name, **Rule3**, for example, to define it. See Figure 4-46.

Figure 4-46 Abandoned object



- 1) There is a default yellow box on the video image which you can click and drag to the wanted position. Also, you can click the box corners to adjust the box shape. However, for many cases, you might need to click **Clear** to clear the default box and click **Draw Rule** to define box:

Based on the scene you want to monitor (a pentagon area, for example), draw a pentagon around the area. Draw a line (parallel to the pentagon area's one edge) to form the pentagon's one edge. Then along another direction and draw the second line to form the pentagon's another edge... Continue until you have finished drawing the pentagon. Right-click to end drawing.

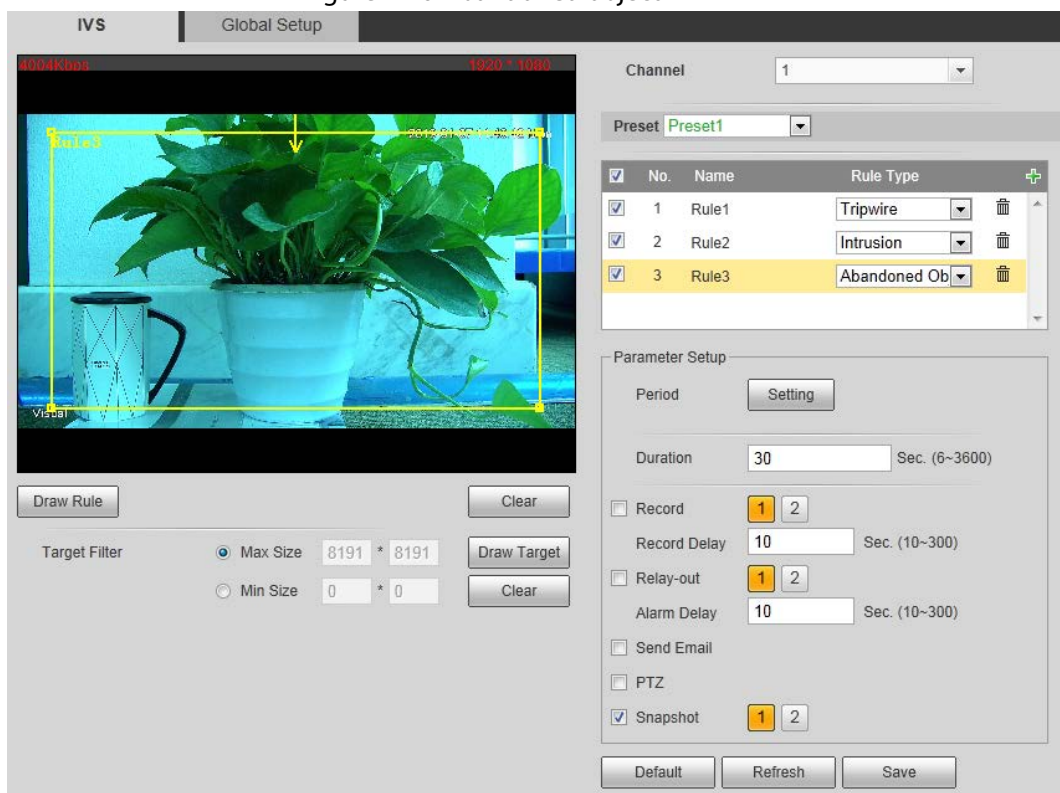
- 2) Select **Max Size** or **Min Size**, then click **Draw Target**, and then drag the filter box's corner to adjust the box's size to your requirement.



- An alarm is triggered only when size of abandoned objects lies between the two filter boxes.

- When drawing a rule, you can select **Max Size** or **Min Size** and click **Clear** to delete a relevant filter box.
- 3) Configure abandoned object parameters. See Table 4-25.

Table 4-25 Abandoned object parameters

Parameter	Description
Period	<p>Define a period during which the alarm settings are active.</p> <ol style="list-style-type: none"> 1. Click Setting, and the period setting interface is displayed. 2. Configure period. <ul style="list-style-type: none"> • Method 1: Hold down and drag the left mouse button to select working period you need. • Method 2: Select Setting > Event > Video Detection and click Setting on the right side of Period. An interface is displayed. In this interface, there are seven Settings altogether each of which corresponds to a day in a week. Select a Setting you want and there are six periods (period1-period6) below for you to pick up. 3. Click Save of working period.
Duration	The shortest time from placing an object in the detection area to an alarm is triggered.
Alarm Track	Enable this function and when tripwire is triggered, the Camera will use thermal lens or visual lens to track the object.
Track Time	Time for the lens to track the object.

Step 4 To set linked measures such as Audio Linkage and White Light when the rule box detects an object, see "4.4.10 Configure Linked Measures."

Step 5 Click **Save**.

4.4.2.2.4 Missing Object

When an object is taken away from the detection area and the absent time of the object is longer than the defined one, an alarm will be triggered and linked activities will be executed.

Procedure

Step 1 Select **Setting > Smart Thermal > IVS**.

The **Rule Config** interface is displayed.

Step 2 Select a preset in **Preset** bar.

The camera turns to the position.

Step 3 Set rules about those missing objects.

- 1) Click  to add a rule. In the **Rule Type** column list, select **Abandoned Object**. In the **Name** column, double-click a name, **Rule4**, for example, to define it. See Figure 4-47.

Figure 4-47 Missing object



- 2) There is a default yellow box on the video image which you can click and drag to the wanted position. Also, you can click the box corners to adjust the box shape. However, for many cases, you might need to click **Clear** to clear the default box and click **Draw Rule** to define box:

Based on the scene you want to monitor (a pentagon area, for example), draw a pentagon around the area. Draw a line (parallel to the pentagon area's one edge) to form the pentagon's one edge. Then along another direction and draw the second line to form the pentagon's another edge... Continue until you have finished drawing the pentagon. Right-click to end drawing.

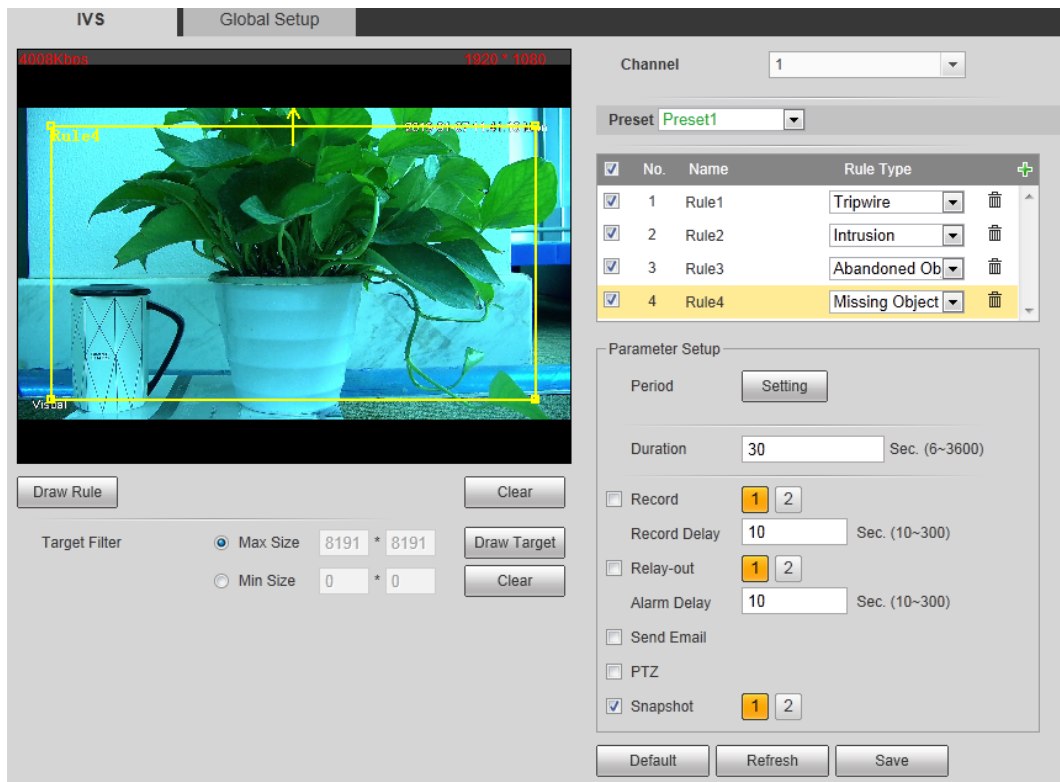
- 3) Select **Max Size** or **Min Size**, then click **Draw Target**, and then drag the filter box's corner to adjust the box's size to your requirement.



- An alarm is triggered only when size of the missing object lies between the two filter boxes.
- When drawing a rule, you can select **Max Size** or **Min Size** and click **Clear** to delete a relevant filter box.

- 4) Configure missing object parameters. See Table 4-26.

Table 4-26 Missing object parameters

Parameter	Description
Period	<p>Define a period during which the alarm settings are active.</p> <ol style="list-style-type: none"> Click Setting, and the period setting interface is displayed. Configure period. <ul style="list-style-type: none"> Method 1: Hold down and drag the left mouse button to select working period you need. Method 2: Select Setting > Event > Video Detection and click Setting on the right side of Period. An interface is displayed. In this interface, there are seven Settings altogether each of which corresponds to a day in a week. Select a Setting you want and there are six periods (period1-period6) below for you to pick. Click Save of working period.
Duration	Time from when an object is taken away from the rule box to when linked measures such as Audio Linkage, White Light and Relay-out are triggered.
Alarm Track	Select the check box and when the rule box detects a missing object, the Camera will use thermal lens or visual lens to track it.
Track Time	Time for the lens to track the object.

Step 4 To set linked measures such as Audio Linkage and White Light when the rule box detects an object, see "4.4.10 Configure Linked Measures."

Step 5 Click **Save**.

4.4.2.3 Global Setup

Preparation

You have set smart plans of presets or channels. See "4.4.1 Configuring Smart Plan" for detailed operations.

Procedure

Step 1 Select **Setting > Smart Thermal > IVS > Global Setup**.
The **Global Setup** interface is displayed. See Figure 4-48.

Figure 4-48 Global setup

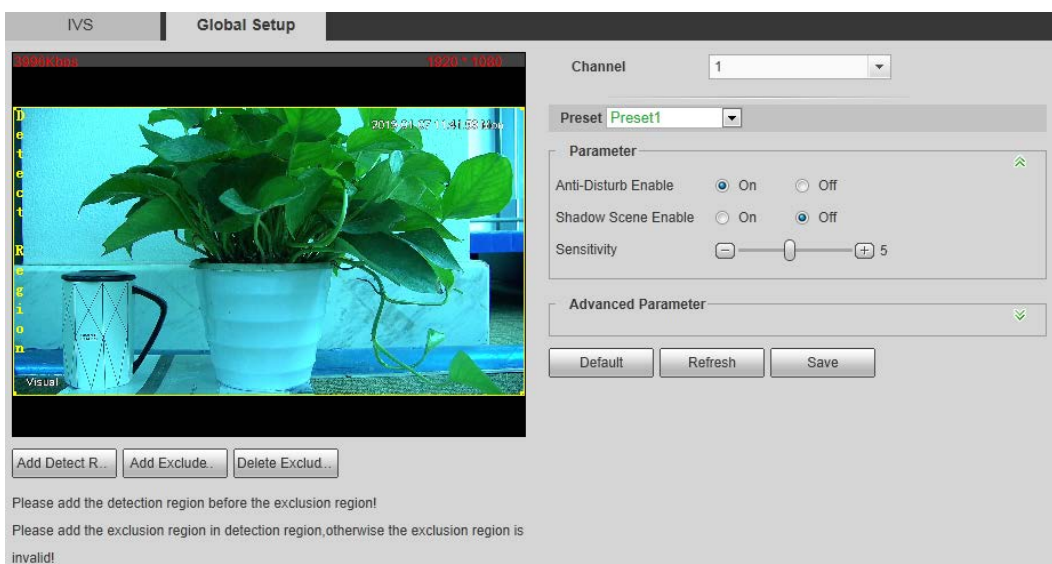

Step 2 Select a preset in **Preset** bar.
The camera turns to the position.



You need this step only when presets are supported in this Camera.

Step 3 Add detected area and excluded area.

1) Click **Add Detect Region** to draw a detected area on surveillance image. Right-click to end drawing.



Click **Add Detect** again to redraw.

2) Click **Add Excluded Area** to draw an excluded area on surveillance image. Right-click to end drawing.



- Click **Delete Excluded Area** to delete the excluded area.
- An excluded area takes effect only when it has been drawn in the detected area.
- Multiple excluded areas can be drawn in the detected area.

Step 4 Configure global setup parameters. See Table 4-27.

Table 4-27 Global setup parameters

Parameter	Description
Anti-Disturb Enable	Select the On check box to enable this function. This function is aimed at eliminating disturbance caused by shaking leaves or waving water.
Shadow Screen Enable	Select the On check box to enable this function. This function is aimed at eliminating an object's shadow and representing only the object itself in the object box; several objects with their shadows partly overlaid can be told separately. So this function can give user a precise clue of where the object really locates. However, if an object's part looks like the object's shadow, it's likely that this part will be identified as a shadow and eliminated.
Sensitivity	The larger this value is, the easier an alarm will be to be triggered by low-contrast or tiny objects.

Isotherm Filter	Select the On check box and set per Limit Threshold and Lower Limit Threshold on your own needs. This function is aimed at diminishing false alarms caused by waving water.
Tracking Overlap Rate	When overlap rate of an object at this moment and at earlier time is smaller than the rate you have set, this object can be detected and an alarm is triggered.
Valid Tracking Distance	Only when an object's moving distance is larger than valid tracking distance you have set, this object can be detected and an alarm is triggered.
Valid Tracking Time	Only when an object's moving time is larger than valid tracking time you have set, this object can be detected and an alarm is triggered.

Step 5 Click **Save**.

4.4.3 Call Detection

Configure call detection to help you monitor the calling behavior at locations such as gas stations. Once a calling is detected, alarm and email will be triggered to alert phone callers and inform you to take actions.

4.4.3.1 Configure Smart Plan

Select a preset for which you can enable the Call Detection first. Then you can configure detailed settings.

Go to the **Live** interface and select **Preset** in **PTZ function** box. Then select a preset number and click  to examine whether or not it's the scene where you want to monitor calling behavior. See Figure 4-49. If not, go to **Setting > PTZ > Function > Preset** to add a new preset.



Figure 4-49 **PTZ function**



Step 1 Go to **Setting > Smart Thermal > Smart Plan**. The **Smart Plan** interface is displayed.

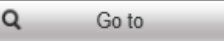
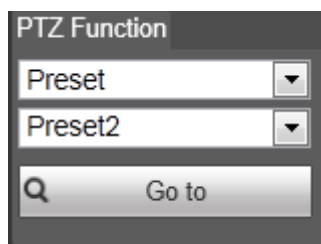
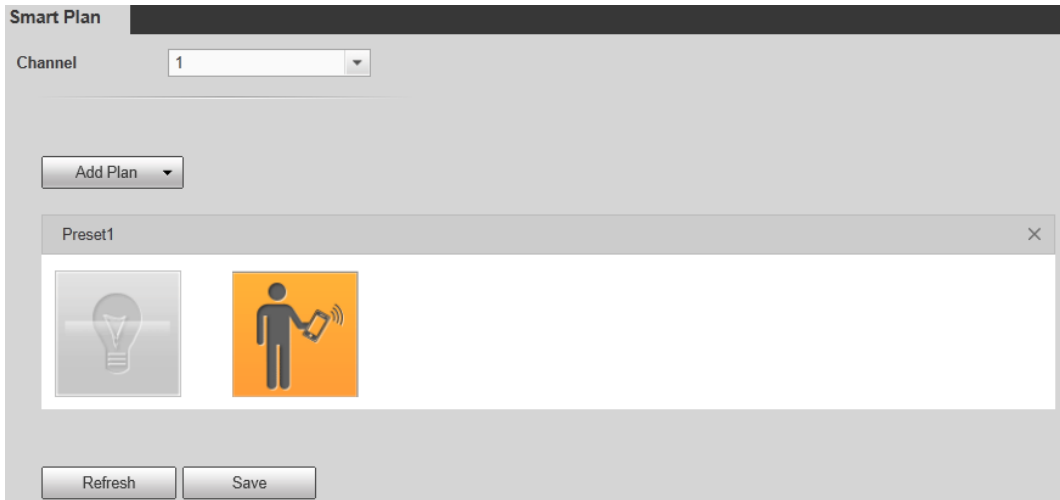

Step 2 Select **1** in **Channel** box and click **Add Plan** to select a preset.

Step 3 (You might need to firstly click  to disable the corresponding IVS function.) Click  to enable Call Detection. The icon  turns into .

Step 4 Click **Save**.

4.4.3.2 Configure Call Detection

Step 1 Select **Setting > Smart Thermal > Call Detection**.
The **Call Detection** interface is displayed.

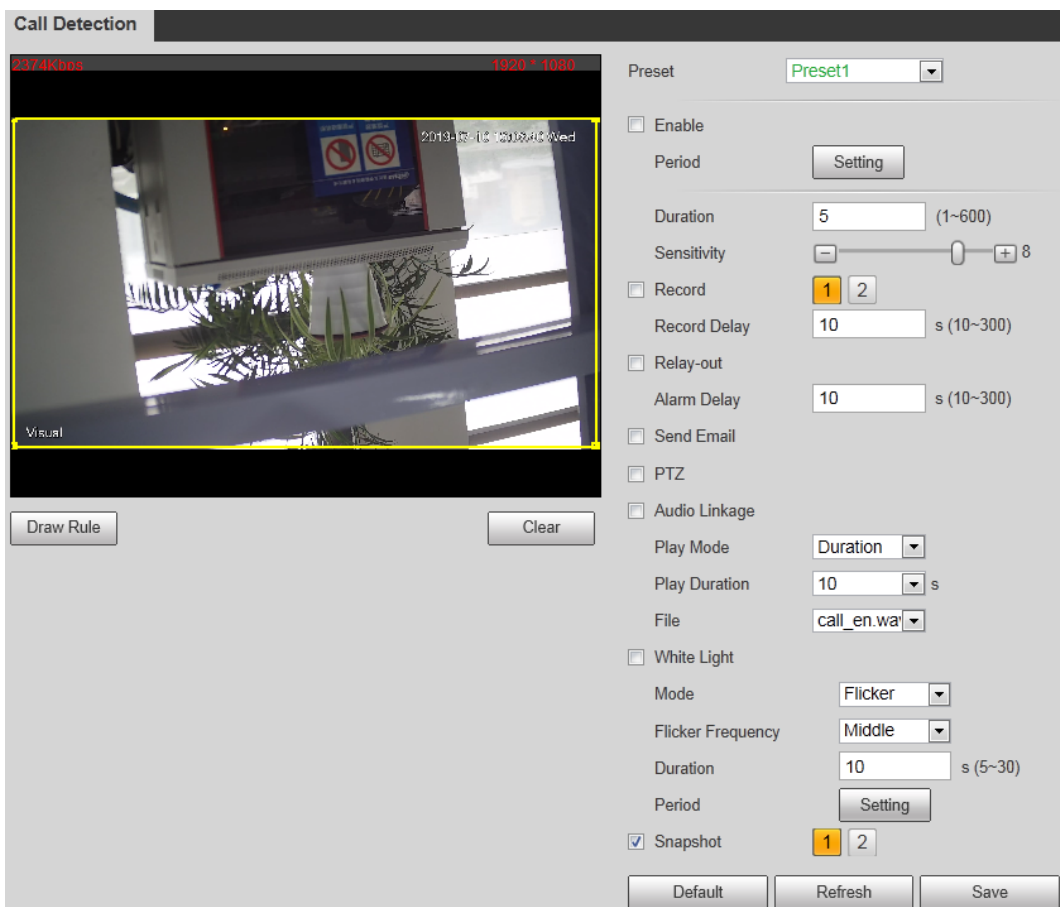

- Step 2 In **Preset** box, select a preset (the blue font, , for example, means the preset has already enabled Call Detection).
- Step 3 The whole surveillance image is set as the call detection area by default (as indicated by the yellow box). If you want to form a specific area, a pentagon, for example, click **Clear** to clear the yellow box. Then click **Draw Rule** and draw a polygon to form the area you want to monitor.
- Step 4 If you want to define a specific period (4:00–23:59, for example) for the call detection to work (this means perhaps you don't need to pay attention to the scene at 00:00–4:00), click **Setting** next to **Period** to define every day in a week.
- Step 5 If you want to set the lasting time of calling behavior beyond which the linked action such as **Relay-out**, **Send Email** and **Record** will be triggered, fill in a value from **1** to **600** in the **Duration** box (the default value is **5**). For example, if you are at a gas station and pay much attention to calling behavior, set **Duration** to **2** or a less value.
- Step 6 If you want to set the sensitivity, drag the sliding block next to **Sensitivity**. The larger the value is, the more sensitive the call detection will be.
- Step 7 Select **Enable** to enable the preset's call detection.
- Step 8 For linked action settings, see "4.4.10 Configure Linked Measures."
- Step 9 Click **Save**.

4.4.3.3 View Web Interface Alarm Records

After finishing settings in "4.4.3.1 Configure Smart Plan" and "4.4.3.2 Configure Call Detection", select **Alarm** tab and select **IVS** in **Alarm Type** to enable alarm notifications on the web interface.

Then view calling behavior records on the **Alarm** tab when an alarm is triggered.

4.4.4 Smoking Detection

4.4.4.1 Configure Smart Plan

Select a preset for which you can enable the Smoking Detection first. Then you can configure detailed settings.

Go to the **Live** interface and select **Preset** in **PTZ function** box. Then select a preset number and click to examine whether or not it's the scene where you want to monitor calling behavior. See Figure 4-49. If not, go to **Setting** > **PTZ** > **Function** > **Preset** to add a new preset.



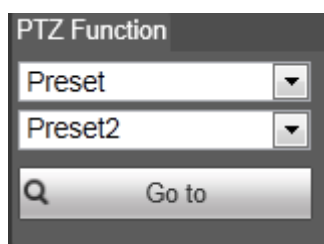

Figure 4-50 PTZ function

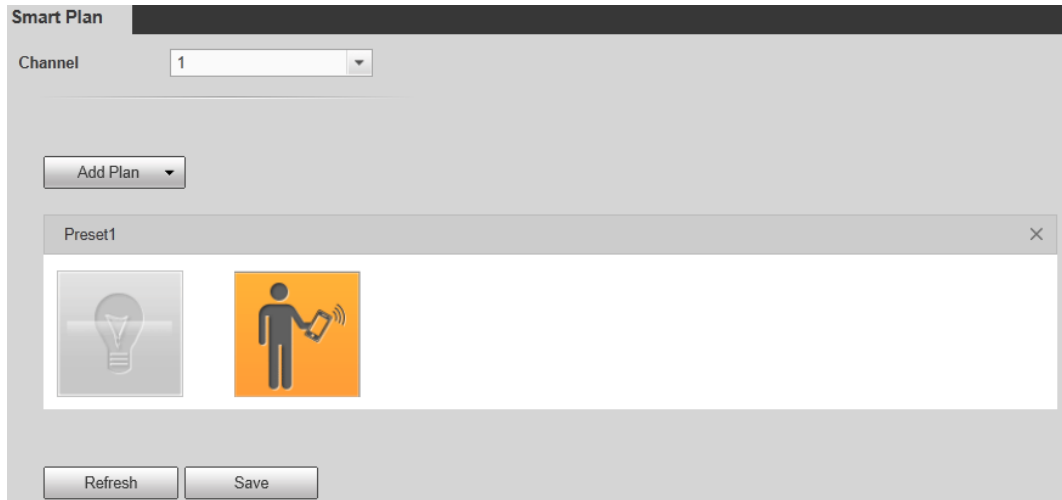

Step 10 Go to **Setting** > **Smart Thermal** > **Smart Plan**. The **Smart Plan** interface is displayed.



Step 11 Select **1** in **Channel** box and click **Add Plan** to select a preset.

Step 12 You might need to click  and  to get the two icons into  and  to disable the corresponding IVS function and Call Detection function. Ensure the two functions are disabled.

Step 13 Click **Save**.

4.4.4.2 Configure Smoking Detection

Step 1 Select **Setting > Smart Thermal > Smoking Detection**.

The **Smoking Detection** interface is displayed.

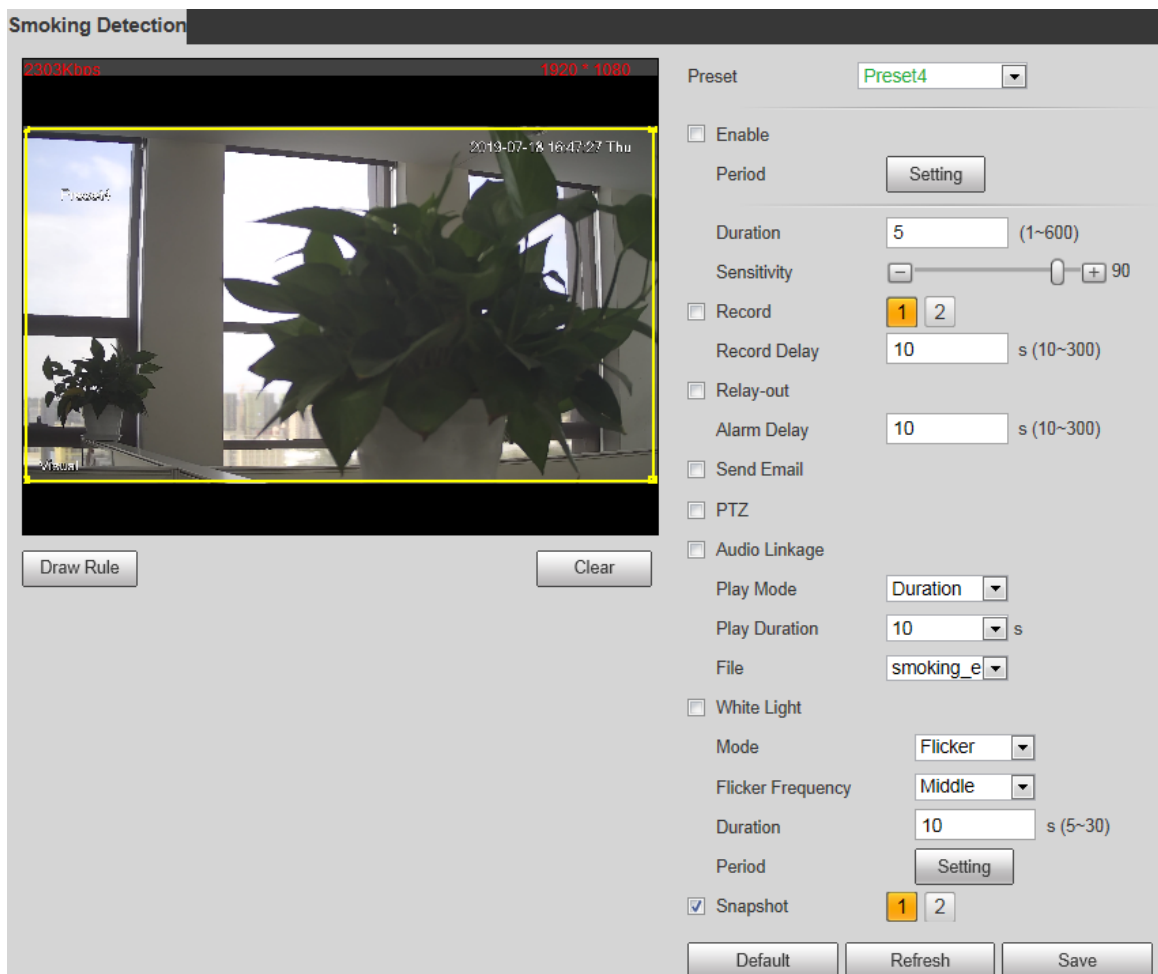

- Step 2 In **Preset** box, select a preset (the blue font, , for example, means the preset has already enabled Smoking Detection).
- Step 3 The whole surveillance image is set as the smoking detection area by default (as indicated by the yellow box). If you want to form a specific area, a pentagon, for example, click **Clear** to clear the yellow box. Then click **Draw Rule** and draw a polygon to form the area you want to monitor.
- Step 4 If you want to define a specific period (4:00–23:59, for example) for the smoking detection to work (this means perhaps you don't need to pay attention to the scene at 00:00–4:00), click **Setting** next to **Period** to define every day in a week.
- Step 5 If you want to set the lasting time of smoking behavior beyond which the linked action such as **Relay-out**, **Send Email** and **Record** will be triggered, fill in a value from **1** to **600** in the **Duration** box (the default value is **5**). For example, if you are at a gas station and pay much attention to calling behavior, set **Duration** to **2** or a less value.
- Step 6 If you want to set the sensitivity, drag the sliding block next to **Sensitivity**. The larger the value is, the more sensitive the call detection will be.
- Step 7 Select **Enable** to enable the preset's call detection.
- Step 8 For linked action settings, see "4.4.10 Configure Linked Measures."
- Step 9 Click **Save**.

4.4.4.3 View Web Interface Alarm Records

After finishing settings in "4.4.4.1 Configure Smart Plan" and "4.4.4.2 Configure Smoking Detection", select **Alarm** tab and select **Smoking Detection** in **Alarm Type** to enable alarm notifications on the web interface.

Then view smoking behavior records on the **Alarm** tab when an alarm is triggered.

4.4.5 Boat Detection

Configure Boat Detection settings such as Tripwire (a boat enters the other side of the drawn line unexpectedly) and Intrusion (a boat enters the drawn area, a rectangular, for example unexpectedly) to help you monitor an area. When Tripwire or Intrusion are triggered, you will be informed to take action.

4.4.5.1 Configure Smart Plan

Select a preset for which you can enable the Boat Detection first. Then you can configure detailed settings.

Go to the **Live** interface and select **Preset** in **PTZ function** box. Then select a preset number and click  to examine whether or not it's the scene that you want to monitor for unexpected boats. See Figure 4-49. If not, go to **Setting > PTZ > Function > Preset** to add a new preset.





Figure 4-51 PTZ function

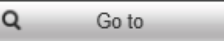
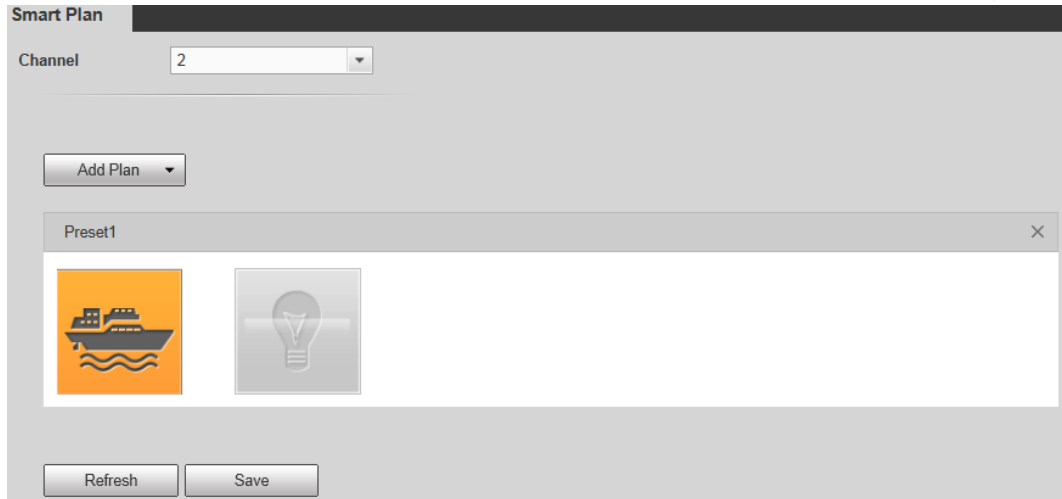

Step 1 Go to **Setting > Smart Thermal > Smart Plan**. The **Smart Plan** interface is displayed.



Step 2 Select **2** in **Channel** box and click **Add Plan** to select a preset.

Step 3 (You might need to firstly click  to disable the corresponding IVS function.) Click  to enable Call Detection. The icon  turns into .

Step 4 Click **Save**.

4.4.5.2 Configure Boat Detection

Configure tripwire and intrusion and the linked actions.

Step 1 Select **Setting > Smart Thermal > Boat Detection**.
The **Boat Detection** interface is displayed.

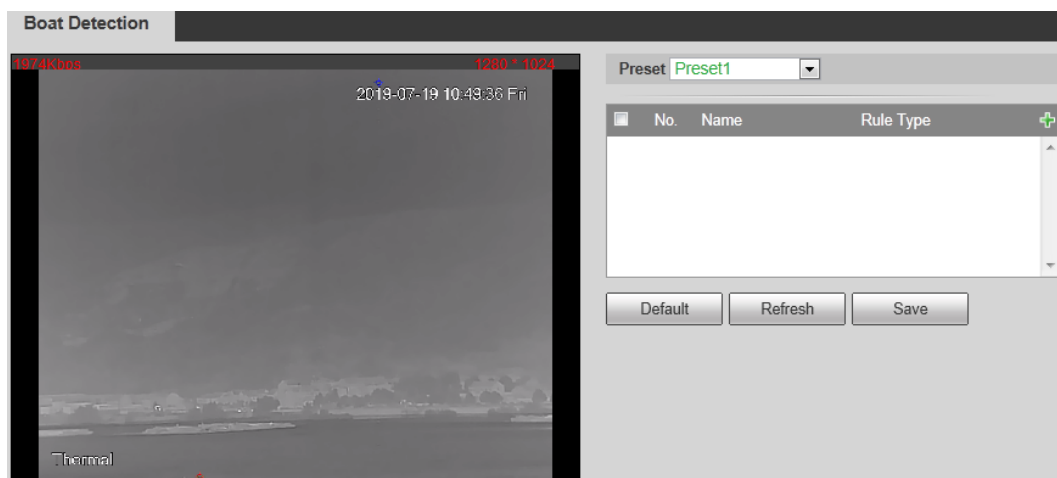

Step 2 Select a preset.

Step 3 Add a detection rule.

For configuration of intelligent rules, see "4.4.2.2 Configuring Intelligent Rules."

4.4.5.3 View Web Interface Alarm Records

After finishing settings in "4.4.5.1 Configure Smart Plan" and "4.4.5.2 Configure Boat Detection", select **Alarm** tab and select **IVS** in **Alarm Type** to enable alarm notifications on the web interface. Then view unexpected boats records on the **Alarm** tab when an alarm is triggered.

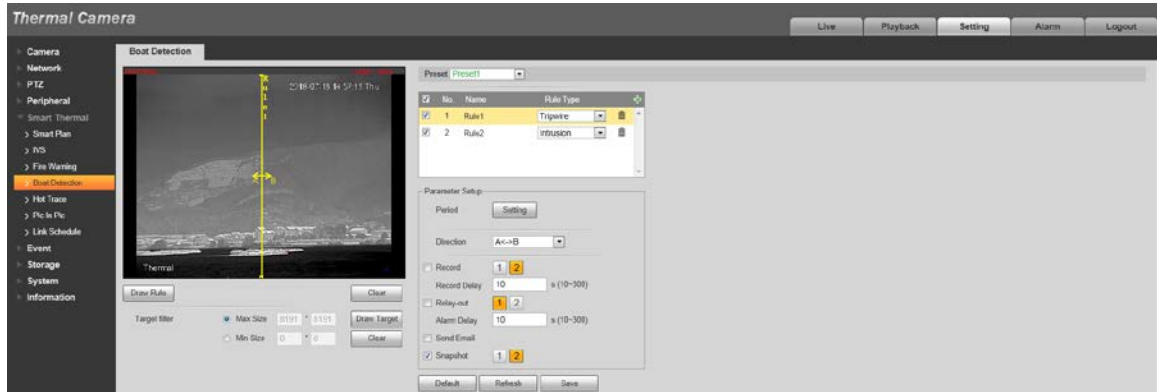

4.4.6 Configuring Fire Warning

The system will give out an alarm once a fire is detected.

Step 1 Select **Setting > Smart Thermal > Fire Warning**.

The **Fire Warning** interface is displayed. See Figure 4-52.

Figure 4-52 Fire warning

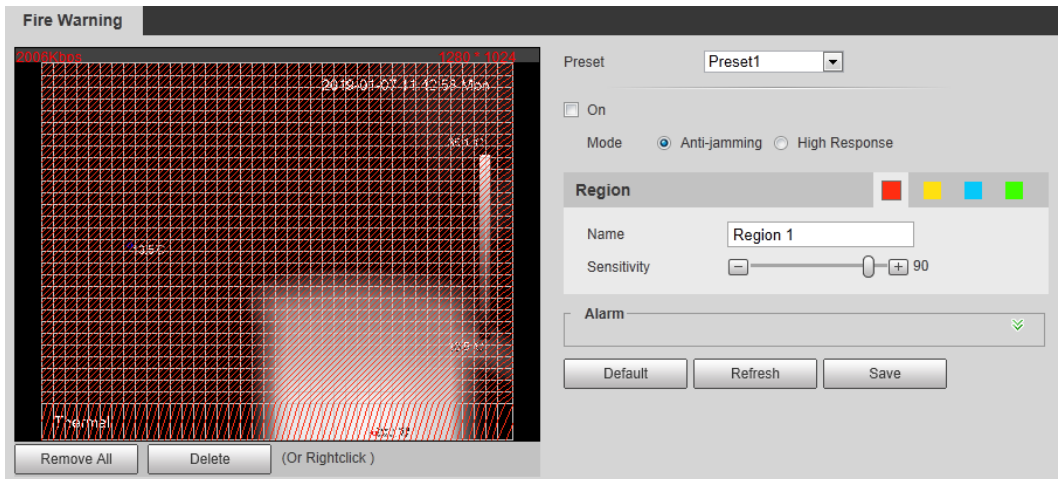

Step 2 Select a preset.

The camera turns to the position.



This step is required only when preset is supported by your Camera.

Step 3 Select the **On** check box.

Step 4 Set rules of fire warning.

1) Select fire warning mode on your own needs.



High response mode is your only option when you want your camera to detect any a hidden fire danger.







- **Anti-jamming:** Your camera will only detect those objects that are newly with high temperature and send off alarms. That means under **Anti-jamming** mode, a constantly high-temperature object (a boiler, for example) is excluded.
 - **High Response:** Your camera will detect any a hidden fire danger and send off alarms.
- 2) Select a color in . Each color represents a certain area which you can draw with your left mouse button. You can also give a name to the area you have drawn and set its sensitivity.
- 
- The larger the sensitivity is, the easier a fire will be triggered.
- 3) Set fire warning parameters. See Table 4-28.

Table 4-28 Fire warning parameters

Parameter	Description
Period	<p>Define a period during which the alarm settings are active.</p> <ol style="list-style-type: none"> 1. Click Setting, and the period setting interface is displayed. 2. Configure period. <ul style="list-style-type: none"> • Method 1: Hold down and drag the left mouse button to select working period you need. • Method 2: Select Setting > Event > Video Detection and click Setting on the right side of Period. An interface is displayed. In this interface, there are seven Settings altogether each of which corresponds to a day in a week. Select a Setting you want and there are six periods (period1-period6) below for you to pick up. 3. Click Save of working period.
Duration	The shortest time from placing an object in the detection area to an alarm is triggered.
Record	<p>Enable this function and alarm recording will be triggered when there is an alarm.</p> <p></p> <ul style="list-style-type: none"> • To view and set storage path of recorded videos, see "4.1.2.5 Configuring Storage Path". • The following two conditions must be satisfied before alarm recording function works: <ul style="list-style-type: none"> ◇ You have enabled motion detection recording. See "4.7.1.1 Configuring Video Recording" for detailed operations. ◇ You have enabled auto recording. See "4.7.3 Configuring Record Control Parameters" for detailed operations.
Record Delay	Set a length of time for the Camera to delay turning off recording after an alarm is ended.
Relay-out	You can connect this relay-out port to such alarm Cameras as light and siren. When an alarm is triggered, those alarm Cameras will work. Select the check box to enable this function.
Alarm Delay	Set a length of time for the Camera to delay turning off alarm after an event is actually ended.

Send Email	<p>Select the Send Email check box and an e-mail will be delivered to the Camera user once an alarm is triggered.</p> <p></p> <p>Set your e-mail first before enabling the Send Email function. See "4.2.5 Configuring SMTP" for detailed operations.</p>
PTZ	<p>Select the check box of PTZ and select an item from None, Preset, Tour, and Pattern in the Activation bar. Once an alarm is triggered, your PTZ will execute the item you have selected in the Activation bar.</p> <p></p> <p>Set PTZ first before enabling this function. See "3.2 PTZ" for detailed operations.</p>
Snapshot	<p>Select the Snapshot check box to take a snapshot when there is an alarm.</p> <p></p> <ul style="list-style-type: none"> To view and set storage path of snapshots, see "4.1.2.5 Configuring Storage Path." To make the snapshot function take effect, you need to firstly enable motion-detection snapshots. See "4.7.1.2 Configuring Snapshot" for detailed operations.

Step 5 Click **Save**.

4.4.7 Configuring Hot Trace

You can enable **Hot Trace** to track spot with the highest temperature and spot with the lowest temperature.

Step 1 Select **Setting > Smart Thermal > Hot Trace**.

The **Hot Trace** interface is displayed. See Figure 4-53.

Figure 4-53 Hot trace

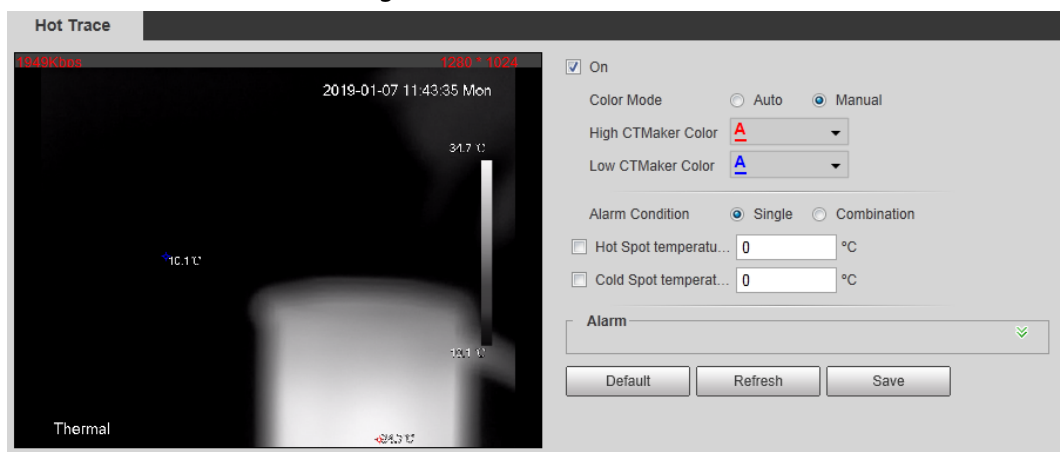





Step 2 Select the **On** check box.

Step 3 Configure parameters of cold/hot spot tracking. See Table 4-29.

Table 4-29 Parameters of hot trace

Parameters	Description
Color Mode	<p>Select a color for cold and hot spots.</p> <ul style="list-style-type: none"> Auto: Select colors for the highest/lowest temperature automatically according to surveillance images. Manual: Define colors for the highest/lowest temperature.

Alarm Condition	<p>Conditions under which an alarm is triggered.</p> <ul style="list-style-type: none"> ● Single <ul style="list-style-type: none"> ◇ Select the Hot Spot temperature more than check box and when the highest temperature is larger than the temperature you have set, an alarm is triggered. ◇ Select the Cold Spot temperature less than check box and when the lowest temperature is smaller than the temperature you have set, an alarm is triggered. ◇ If you select both conditions above at one time, an alarm is triggered once any one condition is satisfied. ● Combination <p>Only when the highest temperature is larger and the lowest temperature is smaller than the temperature you have set, an alarm is triggered.</p>
Period	<p>Define a period during which the alarm settings are active.</p> <ol style="list-style-type: none"> 1. Click Setting, and the period setting interface is displayed. 2. Configure period. <ul style="list-style-type: none"> ● Method 1: Hold down and drag the left mouse button to select working period you need. ● Method 2: Select Setting > Event > Video Detection and click Setting on the right side of Period. An interface is displayed. In this interface, there are seven Settings altogether each of which corresponds to a day in a week. Select a Setting you want and there are six periods (period1-period6) below for you to pick up. 3. Click Save of working period.
Anti-Dither	<p>Only one motion detection event is recorded within the time you have set.</p>
Record	<p>Enable this function and alarm recording will be triggered when there is an alarm.</p>  <ul style="list-style-type: none"> ● To view and set storage path of recorded videos, see "4.1.2.5 Configuring Storage Path". ● The following two conditions must be satisfied before alarm recording function works: <ul style="list-style-type: none"> ◇ You have enabled motion detection recording. See "4.7.1.1 Configuring Video Recording" for detailed operations. ◇ You have enabled auto recording. See "4.7.3 Configuring Record Control Parameters" for detailed operations.
Record Delay	<p>Set a length of time for the Camera to delay turning off recording after an alarm is ended.</p>
Relay-out	<p>You can connect this relay-out port to such alarm Cameras as light and siren. When an alarm is triggered, those alarm Cameras will work. Select the check box to enable this function.</p>
Alarm Delay	<p>Set a length of time for the Camera to delay turning off alarm after an event is actually ended.</p>

Send Email	<p>Select the Send Email check box and an e-mail will be delivered to the Camera user once an alarm is triggered.</p> <p></p> <p>Set your e-mail first before enabling the Send Email function. See "4.2.5 Configuring SMTP" for detailed operations.</p>
PTZ	<p>Select the check box of PTZ and select an item from None, Preset, Tour, and Pattern in the Activation bar. Once an alarm is triggered, your PTZ will execute the item you have selected in the Activation bar.</p> <p></p> <p>Set PTZ first before enabling this function. See "3.2 PTZ" for detailed operations.</p>
Snapshot	<p>Select the Snapshot check box to take a snapshot when there is an alarm.</p> <p></p> <ul style="list-style-type: none"> • To view and set storage path of snapshots, see "4.1.2.5 Configuring Storage Path". • To make the snapshot function take effect, you need to firstly enable motion-detection snapshots. See "4.7.1.2 Configuring Snapshot" for detailed operations.

Step 4 Click **Save**.

Effect of hot trace is as shown in Figure 4-54.



The thermal camera can be classified as temperature-measuring model and observation model according to whether it carries temperature-measuring function. Cold/Hot spot's temperature is not displayed on the Camera of observing model.

Figure 4-54 Effect of hot trace

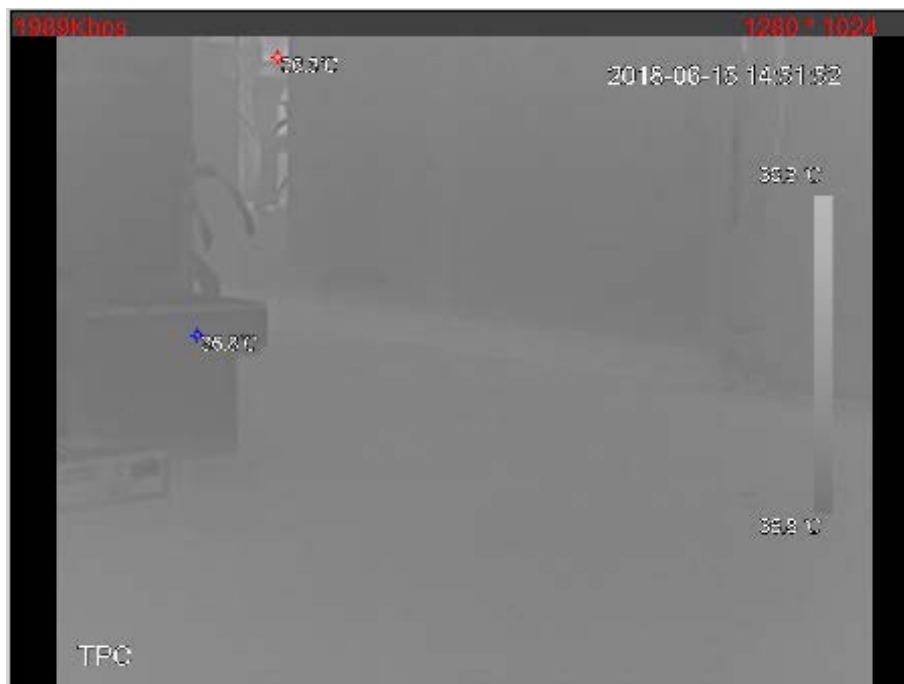

4.4.8 Configuring Pic in Pic

Put the thermal image that has shrunk on the visible image.

- Step 1** Select **Setting > Smart Thermal > Pic in Pic**.
The **Pic in Pic** interface is displayed. See Figure 4-55.

Figure 4-55 Pic in pic

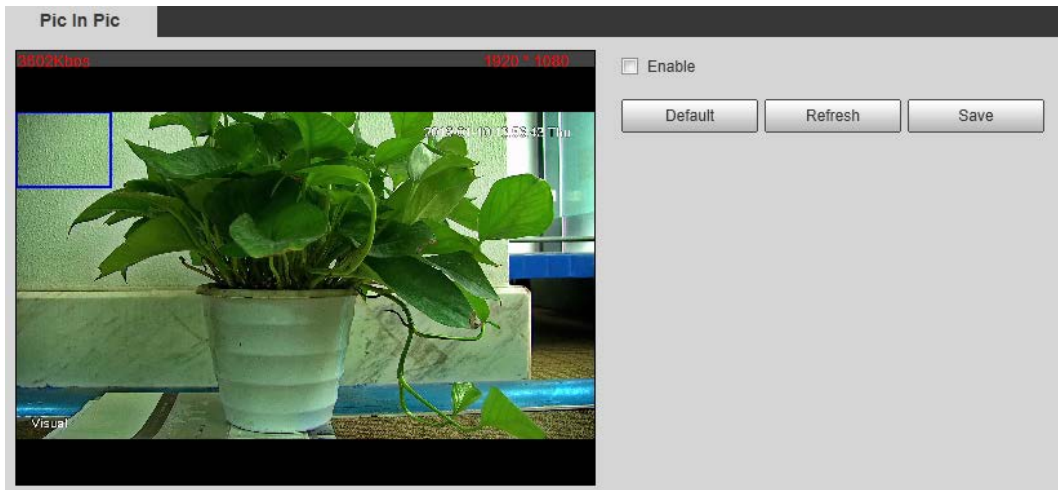

- Step 2** Select the **Enable** check box.
Step 3 Drag the blue box's corner to enlarge the box. Click in the box and drag your mouse to adjust the box's location.
Step 4 Click **Save**.

4.4.9 Configuring Link Schedule

- Step 1** Select **Setting > Smart Thermal > Link Schedule**.
The **Link Schedule** interface is displayed. See Figure 4-56.

Figure 4-56 Link schedule

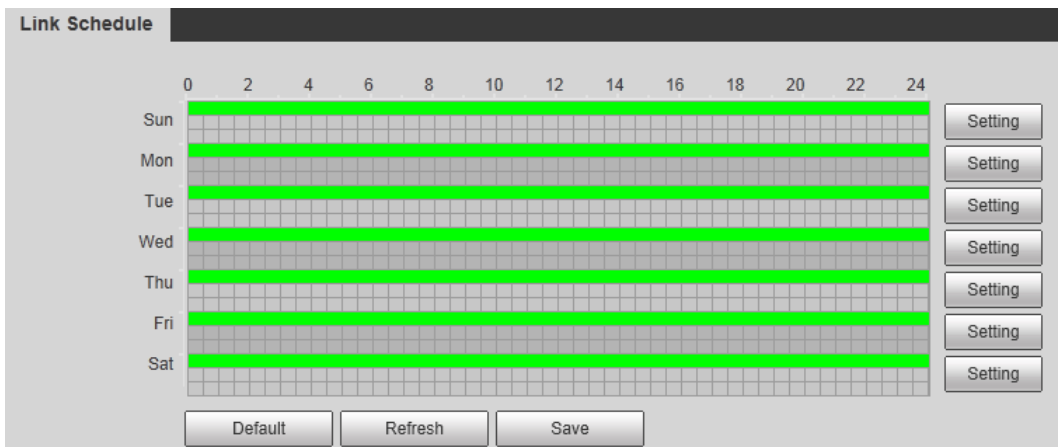

- Step 2** Configure periods for each weekday.



In Figure 4-56, you can hold your mouse's left button to directly drag a period bar for each weekday.

- 1) In Figure 4-56, click **Setting** next to the green bar and the dialogue box of **Setting** is displayed. See Figure 4-57.

Figure 4-57 Setting

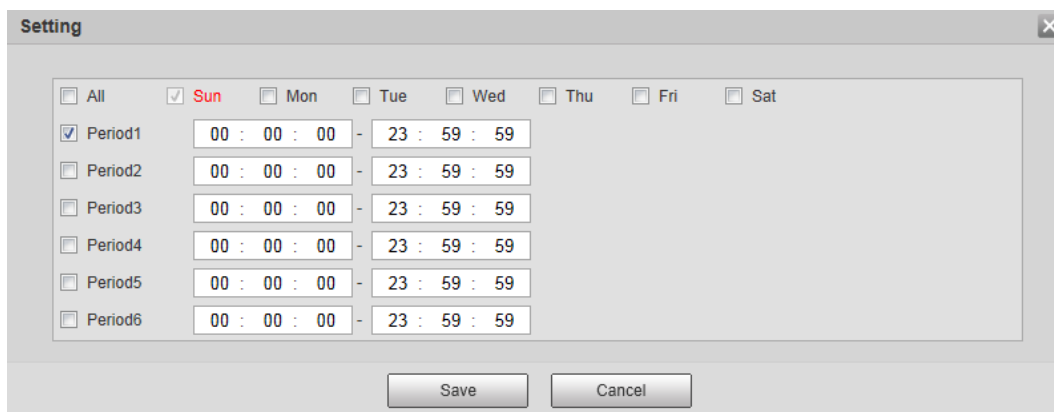

2) Select a weekday and a period. Then you can define the period.



When you select the check box of **All**, you're doing period settings towards all weekdays.

3) Click **Save**. You return to the **Link Schedule** interface.





Step 3 Click **Save**.

4.4.10 Configure Linked Measures

After you configure the Camera intelligent rules, you can set linked actions such as Relay-out, Send Email, PTZ, Record and Snapshot to warn suspicious people & vehicles and inform you to take measures.

Table 4-30 Linked action settings

Item	Description
Period	<p>If you want to define a specific period (4:00–23:59, for example) for a function (smoking detection, for example) to work (this means perhaps you don't need to pay attention to the scene at 00:00–4:00), click Setting next to Period to define every day in a week.</p> <ol style="list-style-type: none"> Next to Period, click Setting, and the period setting interface is displayed. Configure period. <ul style="list-style-type: none"> Method 1: Hold down and drag the left mouse button to select working period you need. Method 2: Select Setting > Event > Video Detection and click Setting on the right side of Period. An interface is displayed. In this interface, there are seven Settings altogether each of which corresponds to a day in a week. Select a Setting you want and there are six periods (period1-period6) below for you to pick up. Click Save of working period.
Duration	The shortest time from placing an object in the detection area to an alarm is triggered.

Record	<p>Enable this function and alarm recording will be triggered when there is an alarm.</p>  <ul style="list-style-type: none"> ● To view and set storage path of recorded videos, see "4.1.2.5 Configuring Storage Path". ● The following two conditions must be satisfied before alarm recording function works: <ul style="list-style-type: none"> ◇ You have enabled motion detection recording. See "4.7.1.1 Configuring Video Recording" for detailed operations. ◇ You have enabled auto recording. See "4.7.3 Configuring Record Control Parameters" for detailed operations.
Record Delay	Set a length of time for the Camera to delay turning off recording after an alarm is ended.
Relay-out	You can connect this relay-out port to such alarm Cameras as light and siren. When an alarm is triggered, those alarm Cameras will work. Select the check box to enable this function.
Alarm Delay	Set a length of time for the Camera to delay turning off alarm after an event is actually ended.
Send Email	<p>Select the Send Email check box and an e-mail will be delivered to the Camera user once an alarm is triggered.</p>  <p>Set your e-mail first before enabling the Send Email function. See "4.2.5 Configuring SMTP" for detailed operations.</p>
PTZ	<p>Select the check box of PTZ and select an item from None, Preset, Tour, and Pattern in the Activation bar. Once an alarm is triggered, your PTZ will execute the item you have selected in the Activation bar.</p>  <p>Set PTZ first before enabling this function. See "3.2 PTZ" for detailed operations.</p>
Snapshot	<p>Select the Snapshot check box to take a snapshot when there is an alarm.</p>  <ul style="list-style-type: none"> ● To view and set storage path of snapshots, see "4.1.2.5 Configuring Storage Path". ● To make the snapshot function take effect, you need to firstly enable motion-detection snapshots. See "4.7.1.2 Configuring Snapshot" for detailed operations.

4.5 Event

4.5.1 Configuring Video Detection

4.5.1.1 Configuring Motion Detection

When an object appears and moves fast enough to reach the sensitivity value you have set, the object will be detected and an alarm will be triggered.

Step 1 Select **Setting > Event > Video Detection > Motion Detection**.

The **Motion Detection** interface is displayed. See Figure 4-58.

Figure 4-58 Motion detection setting

The screenshot shows the 'Motion Detection' configuration window. At the top, there are two tabs: 'Motion Detection' and 'Video Tamper'. The 'Motion Detection' tab is selected. Below the tabs, there is a 'Channel' dropdown menu set to '1'. Underneath is an 'Enable' checkbox, which is currently unchecked. Below that are two buttons labeled 'Setting', one for 'Period' and one for 'Area'. The 'Anti-Dither' field is a text input set to '0', with a range of 'Sec. (0~100)'. Below that are two more 'Setting' buttons. The 'Record' checkbox is checked, and next to it are two small buttons labeled '1' and '2'. Below 'Record' is the 'Record Delay' field set to '10', with a range of 'Sec. (10~300)'. The 'Relay-out' checkbox is checked, and next to it are two small buttons labeled '1' and '2'. Below 'Relay-out' is the 'Alarm Delay' field set to '10', with a range of 'Sec. (10~300)'. There are also three unchecked checkboxes: 'Send Email', 'PTZ', and 'Snapshot'. At the bottom of the window are three buttons: 'Default', 'Refresh', and 'Save'.

Step 2 Select the **Enable** check box.

Step 3 Configure a motion detection area.

1) Next to **Area**, click **Setting**.

The **Area** interface is displayed. See Figure 4-59.

Figure 4-59 Area configuration

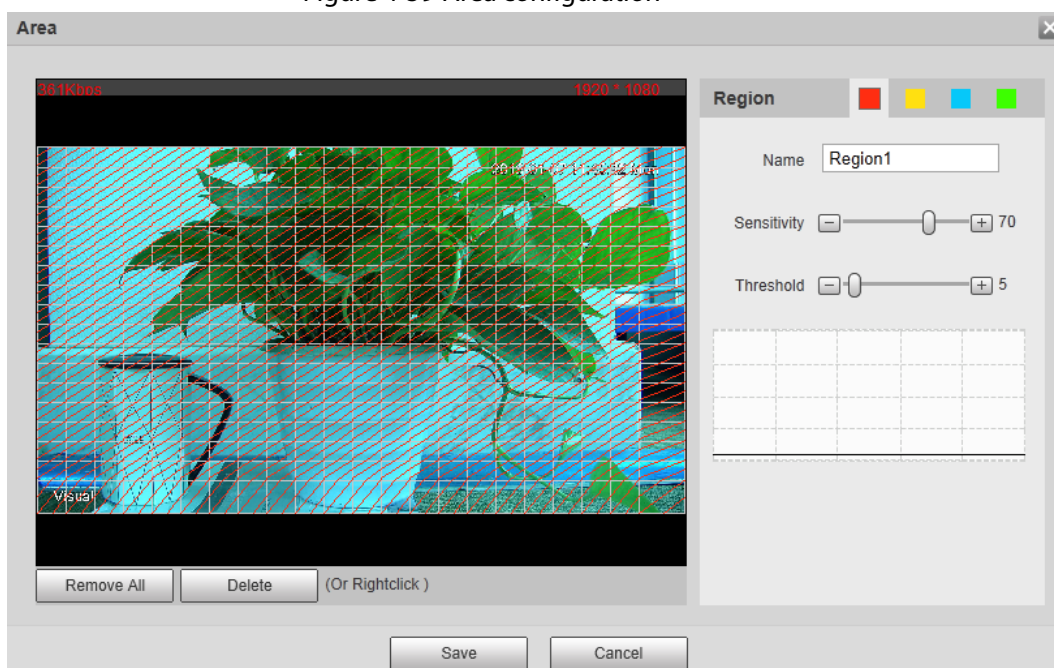

- 2) Set area name and select motion detection areas as needed. You can configure the sensitivity and mutation threshold. The threshold defines the allowed moving area for certain objects. The motion detection will not be triggered as long as those objects stay within the area.







- The higher the sensitivity value is, the easier the motion detection will be triggered; the lower the mutation threshold is, the smaller the allowed moving area for certain objects is, hence the easier the motion detection will be triggered.
- Different colors represent different area. For each area, you can set different sensitivity and mutation threshold.
- In the wave diagram, red line represents motion detection is triggered, and green line represents not.

- 3) Click **Save**.

Step 4 Configure motion detection parameters. See Table 4-31.

Table 4-31 Motion detection parameters

Parameter	Description
Period	<p>Define a period during which the alarm settings are active.</p> <ol style="list-style-type: none"> 1. Click Setting, and the period setting interface is displayed. 2. Configure period. <ul style="list-style-type: none"> • Method 1: Hold down and drag the left mouse button to select working period you need. • Method 2: Select Setting > Event > Video Detection and click Setting on the right side of Period. An interface is displayed. In this interface, there are seven Settings altogether each of which corresponds to a day in a week. Select a Setting you want and there are six periods (period1-period6) below for you to pick up. 3. Click Save of working period.
Anti-Dither	The system records only one motion detection event within the set time.

Record	<p>Enable this function and alarm recording will be triggered when there is an alarm.</p>  <ul style="list-style-type: none"> • To view and set storage path of recorded videos, see "4.1.2.5 Configuring Storage Path". • The following two conditions must be satisfied before alarm recording function works: <ul style="list-style-type: none"> ◇ You have enabled motion detection recording. See "4.7.1.1 Configuring Video Recording" for detailed operations. ◇ You have enabled auto recording. See "4.7.3 Configuring Record Control Parameters" for detailed operations.
Record Delay	Set a length of time for the Camera to delay turning off recording after an alarm is ended.
Relay-out	You can connect this relay-out port to such alarm Cameras as light and siren. When an alarm is triggered, those alarm Cameras will work. Select the check box to enable this function.
Alarm Delay	Set a length of time for the Camera to delay turning off alarm after an event is actually ended.
Send Email	<p>Select the Send Email check box and an e-mail will be delivered to the Camera user once an alarm is triggered.</p>  <p>Set your e-mail first before enabling the Send Email function. See "4.2.5 Configuring SMTP" for detailed operations.</p>
PTZ	<p>Select the check box of PTZ and select an item from None, Preset, Tour, and Pattern in the Activation bar. Once an alarm is triggered, your PTZ will execute the item you have selected in the Activation bar.</p>  <p>Set PTZ first before enabling this function. See "3.2 PTZ" for detailed operations.</p>
Snapshot	<p>Select the Snapshot check box to take a snapshot when there is an alarm.</p>  <ul style="list-style-type: none"> • To view and set storage path of snapshots, see "4.1.2.5 Configuring Storage Path". • To make the snapshot function take effect, you need to firstly enable motion-detection snapshots. See "4.7.1.2 Configuring Snapshot" for detailed operations.

Step 5 Click **Save**.

4.5.1.2 Configuring Video Temper

When your camera lenses are masked, an alarm will be triggered.

Step 1 Select **Setting > Event > Video Detection > Video Temper**.

The **Video Temper** interface is displayed. See Figure 4-58.



Figure 4-60 Video temper

Step 2 Select the **Enable** check box.

Step 3 Configure video temper parameters. See Table 4-31.

Table 4-32 Parameters description

Parameter	Description
Period	<p>Define a period during which the alarm settings are active.</p> <ol style="list-style-type: none"> Click Setting, and the period setting interface is displayed. Configure period. <ul style="list-style-type: none"> Method 1: Hold down and drag the left mouse button to select working period you need. Method 2: Select Setting > Event > Video Detection and click Setting on the right side of Period. An interface is displayed. In this interface, there are seven Settings altogether each of which corresponds to a day in a week. Select a Setting you want and there are six periods (period1-period6) below for you to pick up. Click Save of working period.
Record	<p>Enable this function and alarm recording will be triggered when there is an alarm.</p>  <ul style="list-style-type: none"> To view and set storage path of recorded videos, see "4.1.2.5 Configuring Storage Path". The following two conditions must be satisfied before alarm recording function works: <ul style="list-style-type: none"> You have enabled motion detection recording. See "4.7.1.1 Configuring Video Recording" for detailed operations. You have enabled auto recording. See "4.7.3 Configuring Record Control Parameters" for detailed operations.

Record Delay	Set a length of time for the Camera to delay turning off recording after an alarm is ended.
Relay-out	You can connect this relay-out port to such alarm Cameras as light and siren. When an alarm is triggered, those alarm Cameras will work. Select the check box to enable this function.
Alarm Delay	Set a length of time for the Camera to delay turning off alarm after an event is actually ended.
Send Email	<p>Select the Send Email check box and an e-mail will be delivered to the Camera user once an alarm is triggered.</p>  <p>Set your e-mail first before enabling the Send Email function. See "4.2.5 Configuring SMTP" for detailed operations.</p>
PTZ	<p>Select the check box of PTZ and select an item from None, Preset, Tour, and Pattern in the Activation bar. Once an alarm is triggered, your PTZ will execute the item you have selected in the Activation bar.</p>  <p>Set PTZ first before enabling this function. See "3.2 PTZ" for detailed operations.</p>
Snapshot	<p>Select the Snapshot check box to take a snapshot when there is an alarm.</p>  <ul style="list-style-type: none"> • To view and set storage path of snapshots, see "4.1.2.5 Configuring Storage Path." • To make the snapshot function take effect, you need to firstly enable motion-detection snapshots. See "4.7.1.2 Configuring Snapshot" for detailed operations.

Step 4 Click **Save**.

4.5.2 Configuring Audio Detection

Step 1 Select **Setting > Event > Audio detection**.



The **Audio Detection** interface is displayed. See Figure 4-61.

Figure 4-61 Audio detection settings

Step 2 Configure parameters of audio detection. See Table 4-33.

Table 4-33 Parameters of audio detection

Parameters	Description
Input Abnormal	Enable this function and an alarm will be triggered when there is abnormal audio input.
Intensity Change	Enable this function and an alarm will be triggered when the change of sound intensity exceeds the threshold you have set.
Sensitivity	Volume change of input audio can be identified as audio abnormality only when volume change of input audio is larger than the lasting environment volume. You need to set the lasting environment volume on your own needs.
Threshold	Set the ambient sound intensity you need to filter. The louder the ambient noise is, the bigger this value should be, you can Adjust and test this option as needed.

Period	<p>Define a period during which the alarm settings are active.</p> <ol style="list-style-type: none"> 1. Click Setting, and the period setting interface is displayed. 2. Configure period. <ul style="list-style-type: none"> • Method 1: Hold down and drag the left mouse button to select working period you need. • Method 2: Select Setting > Event > Video Detection and click Setting on the right side of Period. An interface is displayed. In this interface, there are seven Settings altogether each of which corresponds to a day in a week. Select a Setting you want and there are six periods (period1-period6) below for you to pick up. 3. Click Save of working period.
Anti-Dither	The system records only one audio detection event within the set time.
Record	<p>Enable this function and alarm recording will be triggered when there is an alarm.</p>  <ul style="list-style-type: none"> • To view and set storage path of recorded videos, see "4.1.2.5 Configuring Storage Path". • The following two conditions must be satisfied before alarm recording function works: <ul style="list-style-type: none"> ◇ You have enabled motion detection recording. See "4.7.1.1 Configuring Video Recording" for detailed operations. ◇ You have enabled auto recording. See "4.7.3 Configuring Record Control Parameters" for detailed operations.
Record Delay	Set a length of time for the Camera to delay turning off recording after an alarm is ended.
Relay-out	You can connect this relay-out port to such alarm Cameras as light and siren. When an alarm is triggered, those alarm Cameras will work. Select the check box to enable this function.
Alarm Delay	Set a length of time for the Camera to delay turning off alarm after an event is actually ended.
Send Email	<p>Select the Send Email check box and an e-mail will be delivered to the Camera user once an alarm is triggered.</p>  <p>Set your e-mail first before enabling the Send Email function. See "4.2.5 Configuring SMTP" for detailed operations.</p>
PTZ	<p>Select the check box of PTZ and select an item from None, Preset, Tour, and Pattern in the Activation bar. Once an alarm is triggered, your PTZ will execute the item you have selected in the Activation bar.</p>  <p>Set PTZ first before enabling this function. See "3.2 PTZ" for detailed operations.</p>

Snapshot	<p>Select the Snapshot check box to take a snapshot when there is an alarm.</p>  <ul style="list-style-type: none"> • To view and set storage path of snapshots, see "4.1.2.5 Configuring Storage Path". • To make the snapshot function take effect, you need to firstly enable motion-detection snapshots. See "4.7.1.2 Configuring Snapshot" for detailed operations.
----------	--

Step 3 Click **Save**.

4.5.3 Configuring Temperature Alarm

You can set an alarm condition. When the temperature meets the defined alarm condition, an alarm is triggered and the linked activity is executed.



This function is available on select models, and the actual interface shall prevail.

Preparation

You have set the temperature measuring rules. See "4.6.1 Configuring Rules" for detailed operation.

Procedure

Step 1 Select **Setting > Event > Temperature Alarm**.



The **Temperature Alarm** interface is displayed. See Figure 4-62.

Figure 4-62 Temperature alarm settings

Step 2 Select the **Enable** check box.

Step 3 Configure parameters of temperature alarm. See Table 4-34.

Table 4-34 Temperature alarm parameters

Parameter	Description
Period	<p>Define a period during which the alarm settings are active.</p> <ol style="list-style-type: none"> Click Setting, and the period setting interface is displayed. Configure period. <ul style="list-style-type: none"> Method 1: Hold down and drag the left mouse button to select working period you need. Method 2: Select Setting > Event > Video Detection and click Setting on the right side of Period. An interface is displayed. In this interface, there are seven Settings altogether each of which corresponds to a day in a week. Select a Setting you want and there are six periods (period1-period6) below for you to pick up. Click Save of working period.
Anti-dither	Only one temperature alarm event is recorded within the time you have set.
Record	<p>Enable this function and alarm recording will be triggered when there is an alarm.</p>  <ul style="list-style-type: none"> To view and set storage path of recorded videos, see "4.1.2.5 Configuring Storage Path". The following two conditions must be satisfied before alarm recording function works: <ul style="list-style-type: none"> ◇ You have enabled motion detection recording. See "4.7.1.1 Configuring Video Recording" for detailed operations. ◇ You have enabled auto recording. See "4.7.3 Configuring Record Control Parameters" for detailed operations.
Record Delay	Set a length of time for the Camera to delay turning off recording after an alarm is ended.
Relay-out	You can connect this relay-out port to such alarm Cameras as light and siren. When an alarm is triggered, those alarm Cameras will work. Select the check box to enable this function.
Alarm Delay	Set a length of time for the Camera to delay turning off alarm after an event is actually ended.
Send Email	<p>Select the Send Email check box and an e-mail will be delivered to the Camera user once an alarm is triggered.</p>  <p>Set your e-mail first before enabling the Send Email function. See "4.2.5 Configuring SMTP" for detailed operations.</p>
PTZ	<p>Select the check box of PTZ and select an item from None, Preset, Tour, and Pattern in the Activation bar. Once an alarm is triggered, your PTZ will execute the item you have selected in the Activation bar.</p>  <p>Set PTZ first before enabling this function. See "3.2 PTZ" for detailed operations.</p>

Snapshot	<p>Select the Snapshot check box to take a snapshot when there is an alarm.</p>  <ul style="list-style-type: none"> To view and set storage path of snapshots, see "4.1.2.5 Configuring Storage Path". To make the snapshot function take effect, you need to firstly enable motion-detection snapshots. See "4.7.1.2 Configuring Snapshot" for detailed operations.
----------	--

Step 4 Click **Save**.

4.5.4 Configuring Alarm

When there is an alarm from external Cameras, an alarm will be released and linked activities will be executed.

Step 1 Select **Setting > Event > Alarm**.

The **Alarm** interface is displayed. See Figure 4-63.

Figure 4-63 Alarm settings

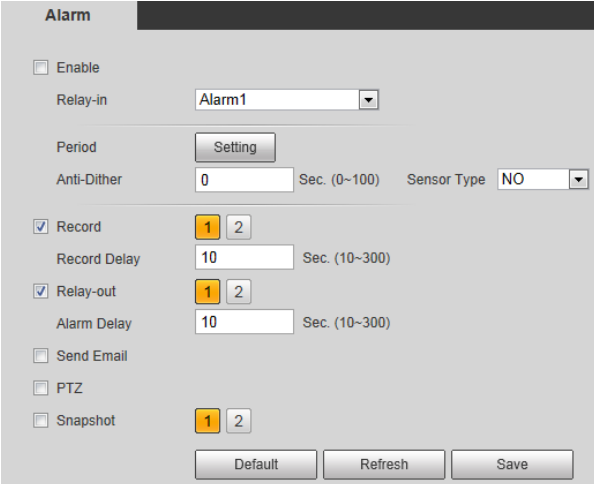





Step 2 Select the **Enable** check box.

Step 3 Configure Relay activation parameters. See Table 4-35.

Table 4-35 Alarm parameters

Parameters	Description
Relay-in	Select an external alarm Camera.
Period	<p>Define a period during which the alarm settings are active.</p> <ol style="list-style-type: none"> Click Setting, and the period setting interface is displayed. Configure period. <ul style="list-style-type: none"> Method 1: Hold down and drag the left mouse button to select working period you need. Method 2: Select Setting > Event > Video Detection and click Setting on the right side of Period. An interface is displayed. In this interface, there are seven Settings altogether each of which corresponds to a day in a week. Select a Setting you want and there are six periods (period1-period6) below for you to pick up. Click Save of working period.
Anti-dither	Only one temperature alarm event is recorded within the time you have set.
Sensor type	You can select from normally open (NO) and normally closed (NC).

Record	<p>Enable this function and alarm recording will be triggered when there is an alarm.</p>  <ul style="list-style-type: none"> • To view and set storage path of recorded videos, see "4.1.2.5 Configuring Storage Path." • The following two conditions must be satisfied before alarm recording function works: <ul style="list-style-type: none"> ◇ You have enabled motion detection recording. See "4.7.1.1 Configuring Video Recording" for detailed operations. ◇ You have enabled auto recording. See "4.7.3 Configuring Record Control Parameters" for detailed operations.
Record Delay	Set a length of time for the Camera to delay turning off recording after an alarm is ended.
Relay-out	You can connect this relay-out port to such alarm Cameras as light and siren. When an alarm is triggered, those alarm Cameras will work. Select the check box to enable this function.
Alarm Delay	Set a length of time for the Camera to delay turning off alarm after an event is actually ended.
Send Email	<p>Select the Send Email check box and an e-mail will be delivered to the Camera user once an alarm is triggered.</p>  <p>Set your e-mail first before enabling the Send Email function. See "4.2.5 Configuring SMTP" for detailed operations.</p>
PTZ	<p>Select the PTZ check box and select an item from None, Preset, Tour, and Pattern in the Activation bar. Once an alarm is triggered, your PTZ will execute the item you have selected in the Activation bar.</p>  <p>Set PTZ first before enabling this function. See "3.2 PTZ" for detailed operations.</p>
Snapshot	<p>Select the Snapshot check box to take a snapshot when there is an alarm.</p>  <ul style="list-style-type: none"> • To view and set storage path of snapshots, see "4.1.2.5 Configuring Storage Path". • To make the snapshot function take effect, you need to firstly enable motion-detection snapshots. See "4.7.1.2 Configuring Snapshot" for detailed operations.

Step 4 Click **Save**.

4.5.5 Configuring Abnormality

Abnormality covers events of SD card, network and illegal access and burning warning.



The "No SD Card", "SD Card Error" and "Capacity Warning" events are available only on models that support SD card.

4.5.5.1 Configuring SD Card Abnormality Parameters

When any abnormality happens to the SD card, an alarm will be triggered and linked activities will be executed. SD card abnormality includes "No SD card", "SD Card Error" and "Capacity Warning."

Step 1 Select **Setting > Event > Abnormality > SD Card**.

The **SD Card** interface is displayed. See Figure 4-64.

Figure 4-64 SD card

Step 2 Select an event type.

Step 3 Select the **Enable** check box.

Step 4 Configure SD card abnormality parameters. See Table 4-36.

Table 4-36 SD card parameter description

Parameters	Description
Minimum storage space in SD card	This parameter can be configured only when the event type is "capacity warning." Configure the free space percentage, and if the free space in the SD card is lower than the set percentage, the alarm is triggered.
Relay-out	You can connect this relay-out port to alarm Cameras such as light and siren. When an alarm is triggered, those alarm Cameras will work. Select the check box to enable this function.
Alarm Delay	Set a length of time for the Camera to delay turning off alarm after an event is actually ended.
Send Email	Select the Send Email check box and an e-mail will be delivered to the Camera user once an alarm is triggered.  Set your e-mail first before enabling the Send Email function. See "4.2.5 Configuring SMTP" for detailed operations.

Step 5 Click **Save**.

4.5.5.2 Configuring Network Abnormality Parameters

When any abnormality happens to network, an alarm will be triggered and linked activities will be executed. Network abnormality includes "Disconnection" and "IP conflict."

Step 1 Select **Setting > Event > Abnormality > Network**.

The **Network** interface is displayed. See Figure 4-65.

Figure 4-65 Network

Step 2 Select an event type.

Step 3 Select the **Enable** check box.

Step 4 Configure network abnormality parameters. See Table 4-37.

Table 4-37 Network parameter description

Parameter	Description
Record	<p>Enable this function and alarm recording will be triggered when there is an alarm.</p>  <ul style="list-style-type: none"> • To view and set storage path of recorded videos, see "4.1.2.5 Configuring Storage Path". • The following two conditions must be satisfied before alarm recording function works: <ul style="list-style-type: none"> ◇ You have enabled motion detection recording. See "4.7.1.1 Configuring Video Recording" for detailed operations. ◇ You have enabled auto recording. See "4.7.3 Configuring Record Control Parameters" for detailed operations.
Record Delay	Set a length of time for the Camera to delay turning off recording after an alarm is ended.
Relay-out	You can connect this relay-out port to such alarm Cameras as light and siren. When an alarm is triggered, those alarm Cameras will work. Select the check box to enable this function.
Alarm Delay	Set a length of time for the Camera to delay turning off alarm after an event is actually ended.

Step 5 Click **Save**.

4.5.5.3 Configuring Illegal Access Parameters

If the password is continuously wrongly typed and the mistakes have reached the maximum you have set, an alarm will be triggered and linked activities will be executed.

Step 1 Select **Setting > Event > Abnormality > Illegal Access**.

The **Illegal Access** interface is displayed. See Figure 4-66.

Figure 4-66 Illegal access

Step 2 Select the **Enable** check box.

Step 3 Configure illegal access parameters. See Table 4-38.

Table 4-38 Illegal access parameter description

Parameters	Description
Login error	The number of times that the login password is allowed to be wrongly entered for. When the login password has been wrongly entered for more than the set times, the account is locked. You need to wait 30 minutes before your account is unlocked.
Relay-out	You can connect this relay-out port to such alarm Cameras as light and siren. When an alarm is triggered, those alarm Cameras will work. Select the check box to enable this function.
Alarm Delay	Set a length of time for the Camera to delay turning off alarm after an event is actually ended.
Send Email	Select the Send Email check box and an e-mail will be delivered to the Camera user once an alarm is triggered.  Set your e-mail first before enabling the Send Email function. See "4.2.5 Configuring SMTP" for detailed operations.

Step 4 Click **Save**.

4.5.5.4 Configuring Lenses Anti-Burning

Configure the lenses' anti-burning parameters and when the lenses are watching directly towards the sun and face the potential burning, the camera will automatically turn to other positions to avoid.



This function is supported on select models and the actual interface shall prevail.

Step 1 Select **Setting > Event > Abnormality > Burning Warning**.

The **Burning Warning** interface is displayed. See Figure 4-67.

Figure 4-67 Burning warning

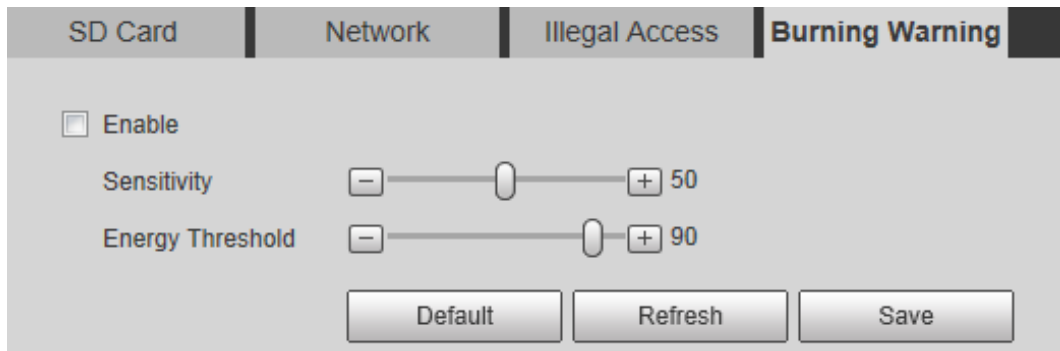

Step 2 Select the **Enable** check box.

Step 3 Configure **Sensitivity** and **Energy Threshold**:

Sensitivity: Sensitivity for the camera to recognize whether the lenses are watching towards the sun. The larger the value is, the easier the camera will be to recognize the sun.

Energy Threshold: The minimum energy value of the object watched by the lenses. Select the energy threshold to filter the low-temperature objects and improve the identification accuracy.

Step 4 Click **Save**.

4.6 Temperature Measuring Settings



Temperature measuring is available on select models and the actual interface shall prevail.

4.6.1 Configuring Rules

Configure temperature measuring rules and when alarm conditions are met, an alarm will be triggered.

4.6.1.1 Configuring Temperature Measuring Rules

Step 1 Select **Setting > Temperature > Rule > Parameter**.

The **Parameter** interface is displayed. See Figure 4-68.

Figure 4-68 Parameter

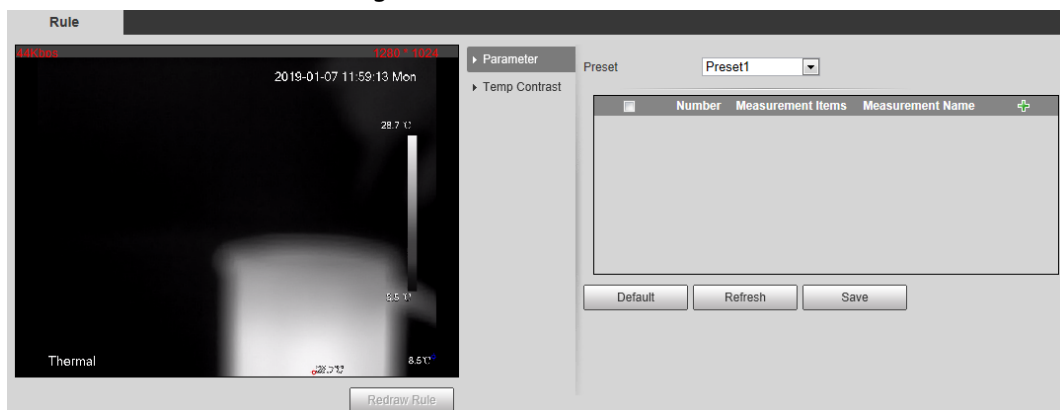

Step 2 Configure temperature measuring rules and then parameters.

- 1) Click  to add a rule.

See Figure 4-69.

Figure 4-69 Rule adding

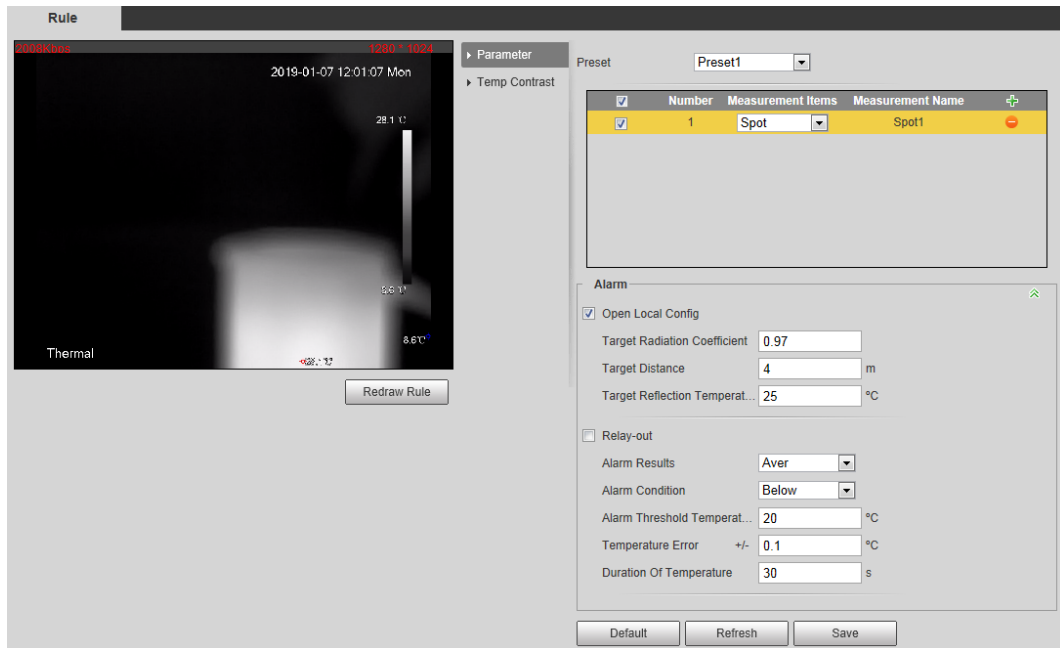

- 2) Double-click the rule you have just added to select monitoring items and modify the monitoring name.
- 3) Draw your rules.
 - Select **Monitoring Items** as **Spot**, and you can click a position on the surveillance image and a spot is formed.
 - Select **Monitoring Items** as **Line**, **Rectangle** or **Ellipse**, and you can hold the left mouse button to draw rules you need on the surveillance image.
 - Select **Monitoring Items** as **Polygon**, and you can hold the left mouse button to draw rules you need on the surveillance image. Right-click to end your drawing.



Select a rule you have drawn and click **Redraw Rule**. Then you can delete the rule and draw a new one.

- 4) Select the **Open Local Config** check box and configure parameters. See Table 4-39.

Table 4-39 Parameter description of local configuration

Parameters	Description
Target Radiation Coefficient	Radiation coefficient of targets that are shot by this Camera. Ranges from 0.5 – 1.
Target Distance	Distance from the camera to targets that are shot. Ranges from 0m – 10000m.
Target Reflection Temperature	Temperature of targets that are shot by this Camera. Ranges from -50 °C to 327.7 °C.

- 5) Enable the **Relay-out** check box and configure its parameters. See Table 4-40.

Table 4-40 Parameter description of relay-out

Parameter	Description
Alarm Results	<p>Temperature's display items.</p> <ul style="list-style-type: none"> • Select Monitoring Items as Spot, and average temperature and temperature slope will be displayed. • Select Monitoring Items as Line, Rectangle, Ellipse or Polygon, and maximum/minimum/average temperature, temperature slope and temperature difference are displayed.  <p>By temperature difference, we mean the difference between maximum and minimum temperatures under rules you have set. By temperature slope, we mean temperature's varying rate under rules you have set.</p>
Alarm Condition	Set alarm conditions, covering Below, Match and Above .
Alarm Threshold Temperature	You can set this value when you select Alarm Results as Max, Min, Aver, or Temperature Difference . Ranges from -40 °C to 550 °C.
Temperature Slope	You can set this value when you select Alarm Results as Slope . By temperature slope, we mean the temperature difference in each minute. Ranges from -600 °C/min – 600 °C/min.
Temperature Error	Set a temperature error value and if the alarm threshold temperature or temperature slope is within the value you have set, linked alarms will still be triggered. Ranges from -10 °C to 10 °C.
Duration of Temperature	You can set a lasting time of abnormal temperature after which alarms will be triggered. Ranges from 0 – 1000s.

Step 3 Click **Save**.

You can watch temperature change under the rules you have set on surveillance images.

4.6.1.2 Configuring Temperature Contrast

You can compare temperature of spots, lines or area you have selected and display comparison results on surveillance images.

Preparation

You have set at least two temperature testing rules. See "4.6.1.1 Configuring Temperature Measuring Rules" for detailed operations.

Procedure

Step 1 Select **Setting > Temperature > Rule > Temp Contrast**.

The **Temp Contrast** interface is displayed. See Figure 4-70.

Figure 4-70 Temperature contrast

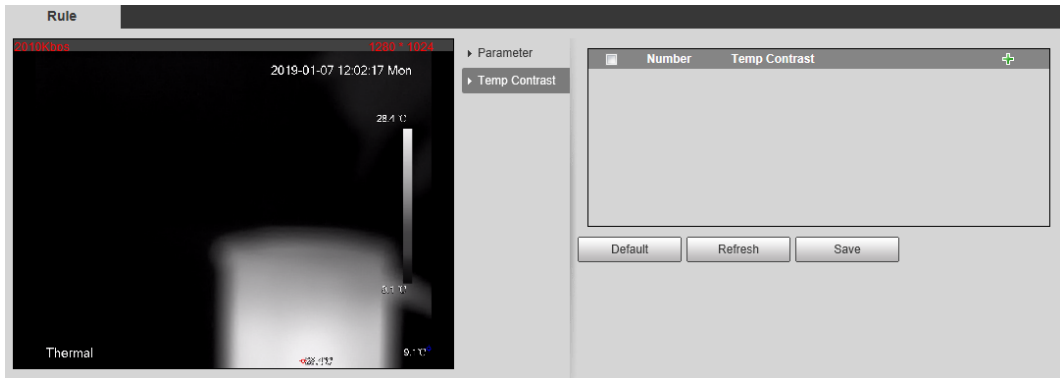

Step 2 Set temperature contrast rules



- 1) Click  to add a temperature contrast rule.
See Figure 4-71.

Figure 4-71 Temperature contrast rules adding

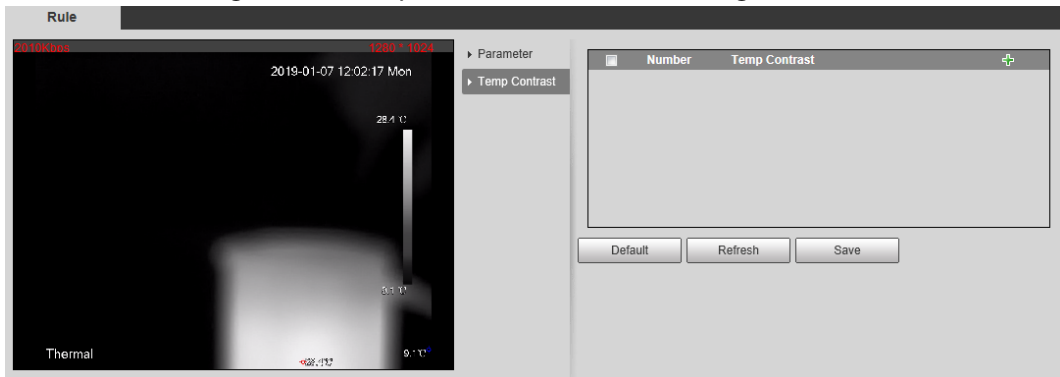

- 2) Double-click to add a temperature contrast rule.
- 3) Set alarm parameters. See Table 4-41.

Table 4-41 Parameters

Parameters	Description
Alarm Results	<p>You can select from the following three options to determine a standard of triggering an alarm.</p> <ul style="list-style-type: none"> ● Average temperature: Compare average temperatures of two rules. ● Maximum temperature: Compare maximum temperatures of two rules. ● Minimum temperature: Compare minimum temperatures of two rules. <p> When one of the two rules refers to a spot, both maximum temperature and minimum temperature are actually average temperature.</p>
Alarm Condition	Contains "lower", "matched" and "higher."
Alarm Threshold Temperature	Temperature of triggering an alarm. Ranges from 0 – 550 °C.

Step 3 Click **Save**.

On the left-side live image, you can view temperature contrast results of the object you have selected.

4.6.2 Configuring Global Setup

You can enable **Temperature Switch**, **Isotherm** and **Color Code**.

- **Temperature Switch:** A switch with which you can enable or disable temperature testing rules. Enable the **Temperature Switch** and the temperature testing rules you have set will be displayed on surveillance images.
- **Isotherm:** Used to highlight an object in images of high brightness. Isotherm is based on median temperature, with highest temperature and lowest temperature as its range. The part of an object whose temperature is higher than floor temperature will be represented in a bright color and the part of an object whose temperature is lower than floor temperature will be represented in a black/white color.
- **Color Code:** Enable this function, and a color code is displayed on the right side of surveillance images to show change of color between minimum temperature and maximum temperature.

Step 1 Select **Setting > Temperature > Global Setup**.

The **Global Setup** interface is displayed. See Figure 4-72.

Figure 4-72 Global setup

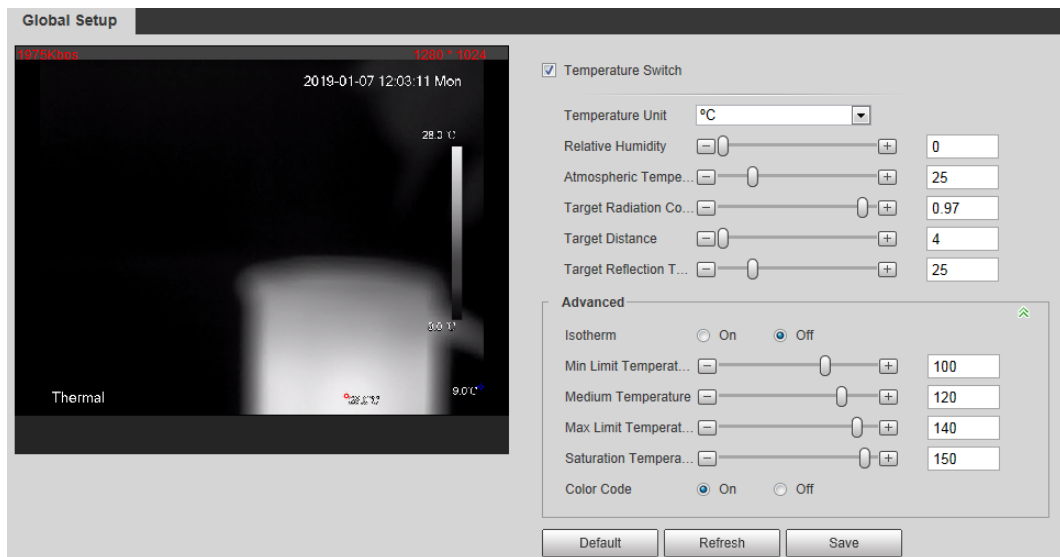

Step 2 Configure the global setup parameters. See Table 4-42.

Table 4-42 Parameter description of global setup

Parameter	Description
Temperature Switch	Select the check box to enable this function.
Temperature Unit	Includes °C and °F.
Relative Humidity	Relative humidity of environment. Ranges from 0RH – 100 %RH.
Atmospheric Temperature	Temperature of our environment. Ranges from -50 °C to 327.7 °C.
Target Radiation Coefficient	Set Radiation coefficient of targets that are shot by this Camera. Ranges from 0.5 – 1.
Target Distance	Distance from the camera to targets that are shot. Ranges from 0m – 10000m.
Target Reflection Temperature	Temperature of targets that are shot by this Camera. Ranges from -50 °C to 327.7 °C.

Isotherm	Select the On check box. You have to make sure that floor temperature <= median temperature <= ceiling temperature <= saturation temperature.
Min Limit Temperature	<ul style="list-style-type: none"> When gain mode is under low-temperature mode, value ranges from -40 °C to 150 °C. When gain mode is under high-temperature mode, value ranges from -40 °C to 600 °C.
Medium Temperature	<ul style="list-style-type: none"> When gain mode is under low-temperature mode, value ranges from -40 °C to 160 °C. When gain mode is under low-temperature mode, value ranges from -40 °C to 600 °C.
Max Limit Temperature	<ul style="list-style-type: none"> When gain mode is under low-temperature mode, value ranges from -40 °C to 160 °C. When gain mode is under low-temperature mode, value ranges from -40 °C to 600 °C.
Saturation Temperature	<ul style="list-style-type: none"> When gain mode is under low-temperature mode, value ranges from -40°C to 160°C. When gain mode is under low-temperature mode, value ranges from -40 °C to 600 °C.
Color Code	Select On to enable color code. A color code will be represented on the right side of surveillance images.

Step 3 Click **Save**.

Effect images are as shown in Figure 4-73, Figure 4-74, and Figure 4-75.

Figure 4-73 Temperature switch



Figure 4-74 Isotherm

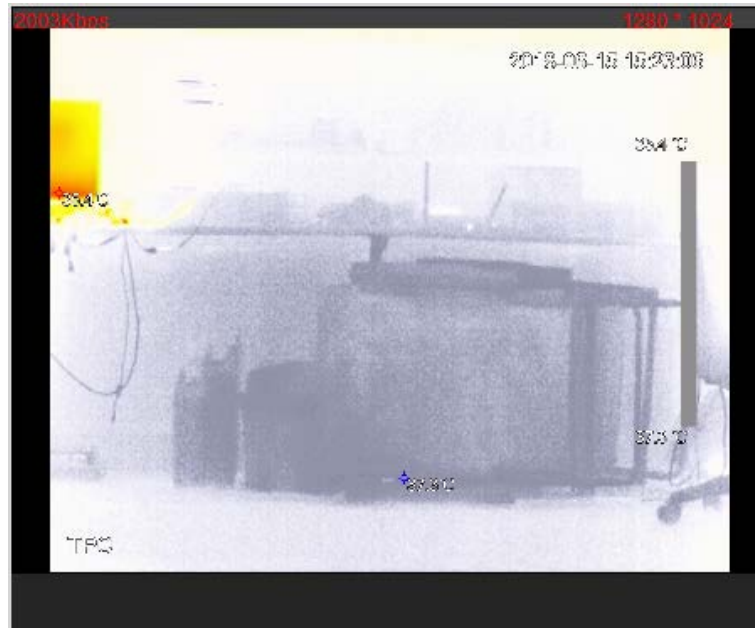

Figure 4-75 Color code



4.6.3 Exporting Heat Map

By exporting heat map, you can grasp temperature of every pixel on thermal images.

Step 1 Select **Setting > Temperature > Heat Map**.

The **Heat Map** interface is displayed. See Figure 4-76.

Figure 4-76 Heat map setting

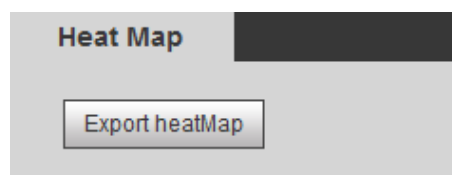

Step 2 Click **Export Heat Map**.

Heat map files will be saved under the path you have set. For detailed operation of resetting the storage path, see "4.1.2.5 Configuring Storage Path."

4.7 Storage Management

4.7.1 Configuring Schedule

You can set schedule of recording, snapshotting, holidays.



If the record mode is **Off** in **Storage > Record Control > Record Control** interface, the system would not record video or snapshot as scheduled.

4.7.1.1 Configuring Video Recording

Set video recording, covering **General**, **Motion** and **Alarm**.

Step 1 Select **Setting > Storage > Schedule > Record**.

The **Record** interface is displayed. See Figure 4-77.

Figure 4-77 Record



Step 2 Select recording type and configure time period.



Select recording type, and then you can also press and hold the left mouse button to select the time period as needed in the chart.

- 1) Click the **Setting** for the day that you want to configure time period.
The **Setting** interface is displayed. See Figure 4-78.

Figure 4-78 Setting

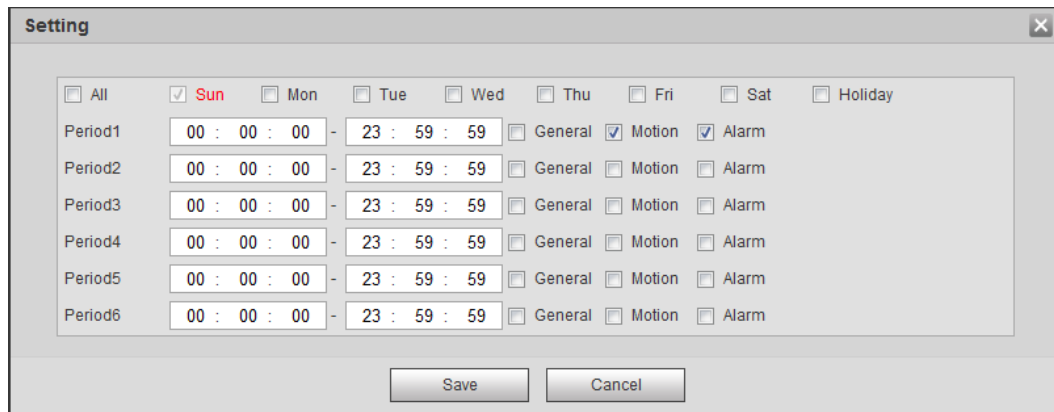

2) Select a day in a week and configure its period.



- There are 6 periods for each day.
- Select the **All** check box, and the entered time period will apply to the whole week. Sunday is selected by default, and you can select other days as needed.

3) Select the record type for the corresponding time period.

4) Click **Save**.

The system returns to the **Record** interface. Each color represents a video type. Green represents general video recording schedule, yellow represents video recording schedule under motion detection and red represents video recording schedule under alarm conditions.

Step 3 Click **Save**.

4.7.1.2 Configuring Snapshot

Set video snapshot schedule, covering **General**, **Motion** and **Alarm**.

Step 1 Select **Setting > Storage > Schedule > Snapshot**.

The **Snapshot** interface is displayed. See Figure 4-79.

Figure 4-79 Snapshot

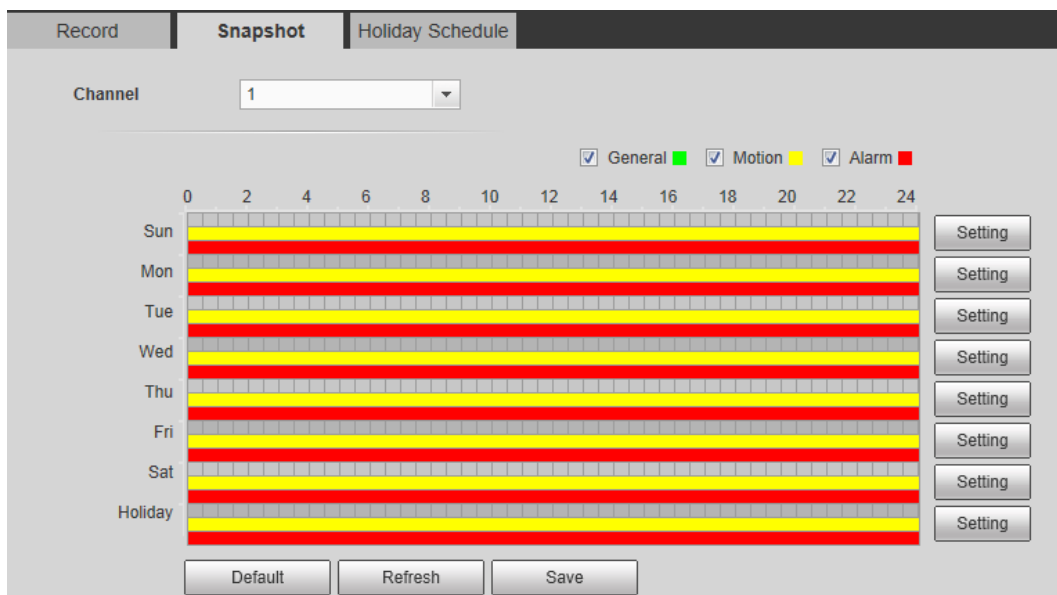

Step 2 Select snapshot type and configure time period.



Select snapshot type, and then you can also hold down the left mouse button to select the time period in the chart as needed.

1) Click the **Setting** for the day that you need to configure time period.

The **Setting** interface is displayed. See Figure 4-80.

Figure 4-80 Settings

	All	Sun	Mon	Tue	Wed	Thu	Fri	Sat	Holiday
Period1	<input type="checkbox"/>	<input checked="" type="checkbox"/>	<input type="checkbox"/>	<input type="checkbox"/>	<input type="checkbox"/>	<input type="checkbox"/>	<input type="checkbox"/>	<input type="checkbox"/>	<input type="checkbox"/>
Period2	<input type="checkbox"/>	<input type="checkbox"/>	<input type="checkbox"/>	<input type="checkbox"/>	<input type="checkbox"/>	<input type="checkbox"/>	<input type="checkbox"/>	<input type="checkbox"/>	<input type="checkbox"/>
Period3	<input type="checkbox"/>	<input type="checkbox"/>	<input type="checkbox"/>	<input type="checkbox"/>	<input type="checkbox"/>	<input type="checkbox"/>	<input type="checkbox"/>	<input type="checkbox"/>	<input type="checkbox"/>
Period4	<input type="checkbox"/>	<input type="checkbox"/>	<input type="checkbox"/>	<input type="checkbox"/>	<input type="checkbox"/>	<input type="checkbox"/>	<input type="checkbox"/>	<input type="checkbox"/>	<input type="checkbox"/>
Period5	<input type="checkbox"/>	<input type="checkbox"/>	<input type="checkbox"/>	<input type="checkbox"/>	<input type="checkbox"/>	<input type="checkbox"/>	<input type="checkbox"/>	<input type="checkbox"/>	<input type="checkbox"/>
Period6	<input type="checkbox"/>	<input type="checkbox"/>	<input type="checkbox"/>	<input type="checkbox"/>	<input type="checkbox"/>	<input type="checkbox"/>	<input type="checkbox"/>	<input type="checkbox"/>	<input type="checkbox"/>

2) Select a day in a week and configure its time period.



- There are 6 time periods for each day.
- Select **All**, and the entered time period would apply to the whole week. Sunday is selected by default, and you can select other days as needed.

3) Select the snapshot type for the corresponding time period.

4) Click **Save**.

The system returns to the **Snapshot** interface. Each color matches with a certain Snapshot type. Green means General Snapshot, yellow means motion detection Snapshot and red means alarm Snapshot schedule.

Step 3 Click **Save**.

4.7.1.3 Configuring Holiday Schedule

Select a day as your "holiday" and video recording/snapshots will be enabled at your "holiday."



- To use holiday recording function, you need to configure holiday recording schedule. For detailed operation, see "4.7.1.1 Configuring Video Recording."
- To use holiday snapshot function, you need to configure holiday record/snapshot schedule. For detailed operation, see "4.7.1.2 Configuring Snapshot."

Step 1 Select **Setting > Storage > Schedule > Holiday Schedule**.

The **Holiday Schedule** interface is displayed. See Figure 4-81.

Figure 4-81 Holiday schedule

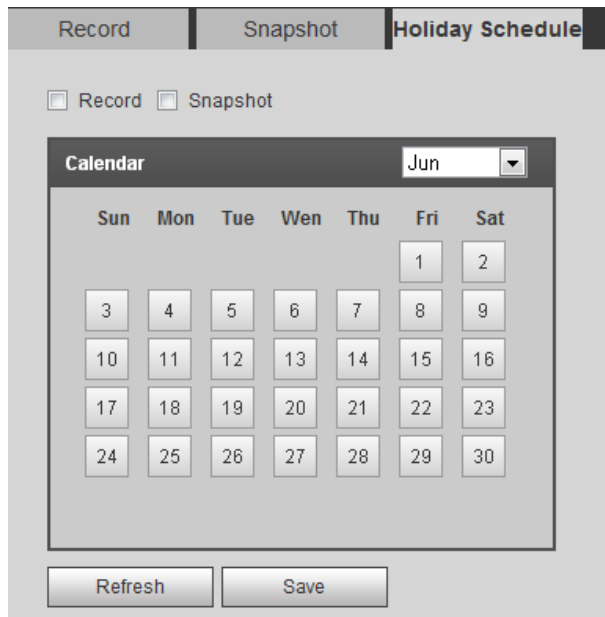

Step 2 Select from record and snapshot.

Step 3 Select days you need to set as your "holiday."

Those days with yellow color indicates they were set as holidays.

Step 4 Click **Save**.

4.7.2 Camera Storage

4.7.2.1 Configuring Storage Path

You can set video recording and snapshot's storage methods according to event types. You can save them in SD card, FTP or NAS.



Local storage is available only on models that support SD card.

Step 1 Select **Setting > Storage > Destination > Path**.

The **Path** interface is displayed. See Figure 4-82.

Figure 4-82 Path



Step 2 Select different storage paths for the recorded videos and snapshots which belong to different event types.

Table 4-43 Path parameters

Parameter	Description
Event type	Select from Scheduled , Motion Detection and Alarm .
Local	Save in the internal SD card.
FTP	Save in the FTP server.
NAS	Save in the NAS (network attached storage).

Step 3 Click **Save**.

4.7.2.2 Configuring Local Storage

The system will display the internal SD card information. You can set it as **Read Only** or **Read & Write**; you can also **Hot Swap** or **Refresh** it.

Select **Setting > Storage > Destination > Local**, and the **Local** interface is displayed. See Figure 4-83.

- Select SD card you need to set and click **Read Only**. Then the SD card is set to read only.
- Select SD card you need to set and click **Read & Write**. Then the SD card is set to read& write.
- Select SD card you need to set and click **Hot Swap**. Then you can pull out the SD card.
- Select SD card you need to set and click **Refresh**. Then the SD card will be formatted.

Figure 4-83 Local storage setting



4.7.2.3 Configuring FTP Server

You can set FTP server only when FTP is selected as the storage method in **Path**. When the network doesn't work, you can save all the files to the local SD card for emergency.

Step 1 Select **Setting > Storage > Destination > FTP**.

The **FTP** interface is displayed. See Figure 4-84.

Figure 4-84 FTP settings

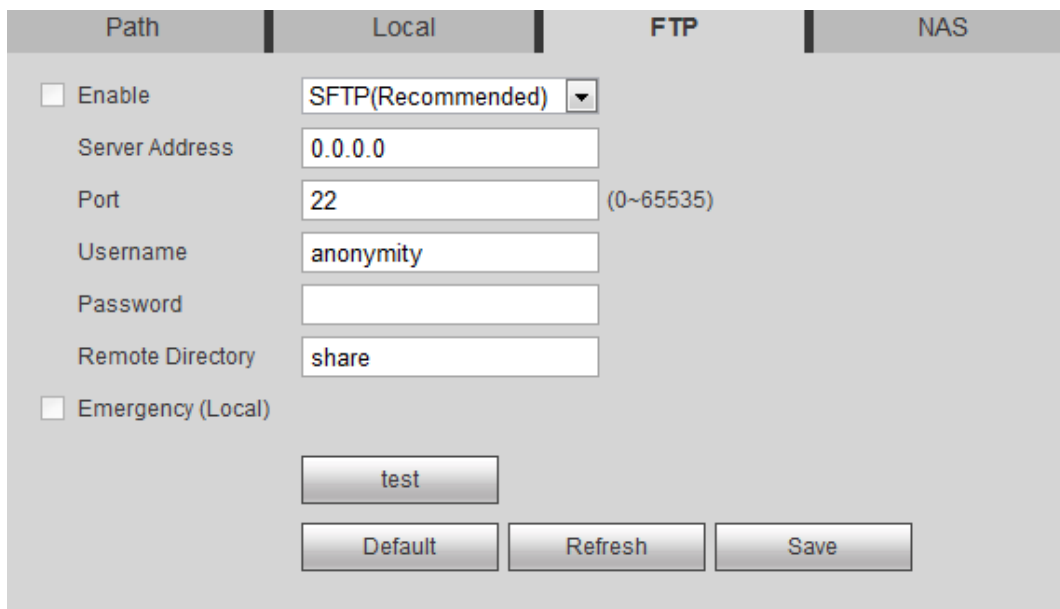

Step 2 Select the **Enable** check box, and then select the service type.



SFTP service is recommended.

Step 3 Configure FTP parameters. See Table 4-44.

Table 4-44 FTP parameter description

Parameters	Description
Server Address	The IP address of the SFTP or FTP server.
Port	The port of the SFTP or FTP server.
User name	The user name to log in the server.
Password	The password to log in the server.
Remote Directory	The destination path in the server.
Emergency (Local)	Select the Emergency (Local) check box, and when the FTP server does not work, all the files are saved to the internal SD card.

Step 4 Click **Save**.

Click **Test** to check whether the server has been properly connected.

4.7.2.4 Configuring NAS Server

This function can be enabled only when NAS has been selected as destination path. Select **NAS** interface and you can save files in NAS server.

Step 1 Select **Setting > Storage > Destination > NAS**.

The **NAS** interface is displayed. See Figure 4-85.

Figure 4-85 NAS settings

Step 2 Select the **Enable** check box.

Step 3 Configure NAS parameters. See Table 4-45.

Table 4-45 NAS parameters

Parameter	Description
Server Address	The IP address of the NAS server.
Remote Directory	The destination path in the NAS server.

Step 4 Click **Save**.

4.7.3 Configuring Record Control Parameters

This chapter introduces configurations including pack duration, pre-event record, disk full, record mode and record stream.

Step 1 Select **Setting > Storage > Record Control**.

The **Record Control** interface is displayed. See Figure 4-86.

Figure 4-86 Record control settings

The screenshot shows a 'Record Control' window with the following settings:

- Pack Duration: 2 (Min. 1~120)
- Pre-event Record: 5 (Sec. 0~5)
- Disk Full: Overwrite
- Record Mode: Auto, Manual, Off
- Record Stream: Main Stream

Buttons at the bottom: Default, Refresh, Save.

Step 2 Configure record control parameters. See Table 4-46.

Table 4-46 Record control parameter description

Parameters	Description
Pack Duration	The duration of each file pack.
Pre-event Record	The time period for which the system records video before alarm, if the value is 5, then the system records video for 5 seconds before alarm starts and save it.  If the Record Mode is Off and the record activity has been linked with alarm or motion detection, the system will still save the pre-event video.
Disk Full	The recording strategy when the disk is full. <ul style="list-style-type: none"> • Stop: The system stops recording when the disk is full. • Overwrite: The system overwrites the oldest files and keep recording when the disk is full.
Record Mode	At the record mode, if you select Manual , the system starts video recording; if you select Auto , the system records video as time period scheduled; if you select Off , video recording will not start.
Record Stream	Includes main stream and sub stream.

Step 3 Click **Save**.

4.8 System Management

4.8.1 General Settings

4.8.1.1 Configuring General Information

Configure Camera name, language and video standard.

Step 1 Select **Setting > System > General > General**.

The **General** interface is displayed. See Figure 4-87.

Figure 4-87 General

Step 2 Configure general parameters. See Table 4-47.

Table 4-47 General parameter description

Parameter	Description
Camera name	The name of the Camera. Each Camera has different name.
Language	Select system language.
Video Standard	Select video standard from PAL and NTSC.

Step 3 Click **Save**.

4.8.1.2 Configuring Date & Time

You can set Date and Time format, Time zone, Current Time, DST (Daylight Saving Time) or NTP server.

Step 1 Select **Setting > System > General > Date & Time**.

The **Date & Time** interface is displayed. See Figure 4-88.

Figure 4-88 Date & Time

Step 2 Configure Date & Time parameters. See Table 4-48.

Table 4-48 Date & Time parameters

Parameter	Description
Date Format	Date format.
Time Format	Configure the Time format, you can select from 24-Hour or 12-Hour.
Time zone	Configure the Time zone that the Camera is at.
Current Time	Configure system time. Click "Sync PC", and the system time changes to the time on PC.
DST	Enable DST as needed. Select the check box to enable daylight saving time. Select "DST", and then configure start time and end time of DST with dates or days of the week.
NTP	When you need the Camera to transmit its time to NTP server, you can select the NTP check box to enable it.
Server	IP address or domain name of the NTP server.
Port	Port number of the FTP server.
Interval	Time gap of Camera's transmission of its current time to NTP server.

Step 3 Click **Save**.

4.8.1.3 Configuring GPS

Fill in the camera's GPS information in the web to remind you where your camera locates.

Also, automatically sent to the management platform, the GPS information can be viewed on the platform to help the platform operator track your camera.



This function is supported on select models and the actual interface shall prevail.

Step 1 Select **Setting > System > General > GPS**.

The **GPS** interface is displayed. See Figure 4-89.

Figure 4-89 **GPS**

Step 2 Fill in your camera's **LON**, **LAT** and **Altitude** information.

Step 3 Click **Save**.

4.8.2 User Management

Managing users and groups are only available for administrator users.

- The max length of the user or group name is 15 characters which can only be consisted of letters, numbers and underlines.
- The password must have 8 to 32 digits and at the same time have at least two forms (There are four password forms altogether: capital letter, lowercase letter, number and special characters. "",

“””, “;”, “:”, and “&” are not covered in special characters.) Administrator users can modify all the users' password.

- You can have 19 users and 8 groups at most.
- You can manage users through single user or group, duplicate user names or group names are not allowed. A user can be in one group at a time and the group users can own authorities within group authority range.
- Online users cannot modify their own authority.
- There is one admin by default which has highest authority.
- Select “Anonymous login”, and then log in with only IP address instead of user name and password. Anonymous users only have preview authorities. During Anonymous login, Click logout, and then you can log in with other username.

4.8.2.1 Adding a Group

You have two groups named admin and user by default, you can add new group, delete added group or modify group authority and memo.

Step 1 Select **Setting > System > Account > Account > Group Name**.

The **Group Name** interface is displayed. See Figure 4-90.

Figure 4-90 User group

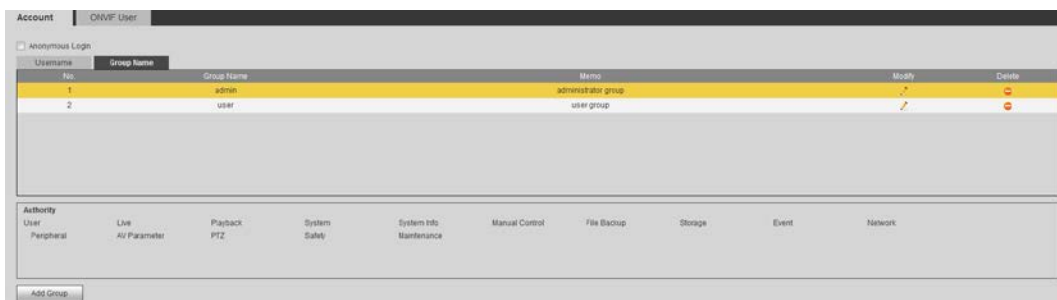

Step 2 Click **Add Group**.

The **Add Group** interface is displayed. See Figure 4-91.

Figure 4-91 Add Group

Add Group

Group Name: **Must**

Memo:

Authority: All

Live

Playback

System

System Info

Save Cancel

Step 3 Enter Group name and memo. Then select Group authorities.

Step 4 Click **Save**.

The newly added group displays in the group name list. See Figure 4-92.





- After adding group, click  to modify group memo or authorities; click  to delete the added group, admin group and user group cannot be deleted.
- Click  in the row of admin group or user group to modify group memo.

Figure 4-92 User group added.



4.8.2.2 Adding a User

You are admin user by default, and you can add user, delete added users or modify their password.

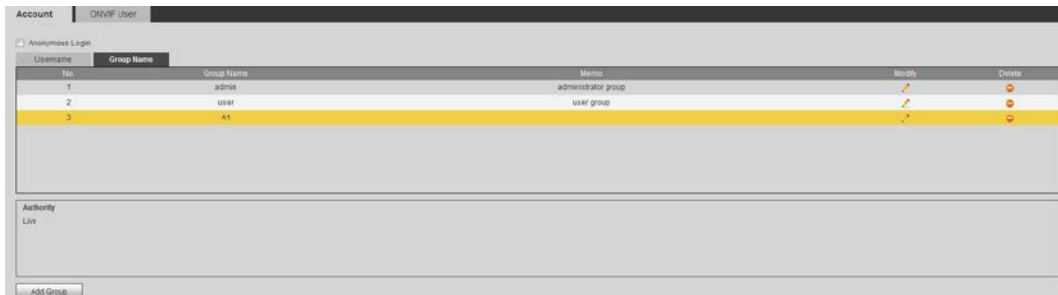
Step 1 Select **Setting > System > Account > Account**.

The **Account** interface is displayed. See Figure 4-93.

Figure 4-93 User settings

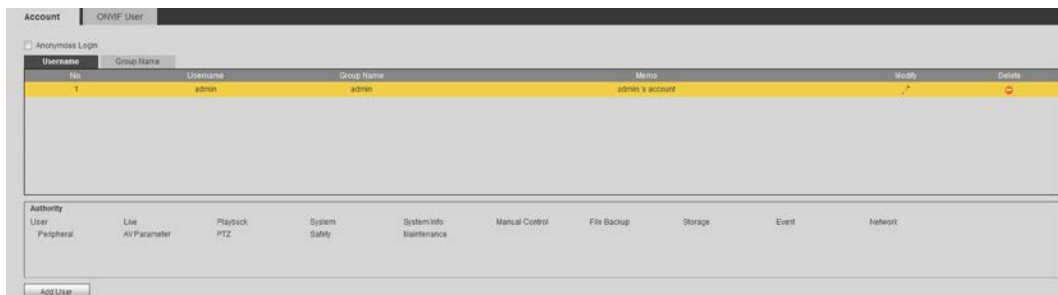

Step 2 Click **Add User**.

The **Add User** interface is displayed. See Figure 4-94.

Figure 4-94 Add user

Step 3 Configure parameters. See Table 4-49.



Table 4-49 User parameter description

Parameter	Description
Username	User's unique identification You cannot use existing user name.
Password	Enter password and confirm it.
Confirm Password	The two items must be the same.
Group name	The group that users belong to. Each group has different authorities.
Memo	Describes the user.
Authority	Select authorities as needed.  It is recommended to give less authority to normal users than premium users.

Step 4 Click **Save**.

The newly added users are displayed in the user list.



- After adding user, click  to modify password, group, memo or authorities; click  to delete the added user, admin user cannot be deleted.
- Click  in the admin row to modify user name and email address.

4.8.2.3 Modifying User Password

For data security, it's strongly recommended that you change the default password of the Camera and modify it regularly. Also, it's recommended that you adopt a complicated and strong password.

Step 1 Select **Setting > System > Account > Account > Username**.

The **Username** interface is displayed. See Figure 4-95.

Figure 4-95 Username

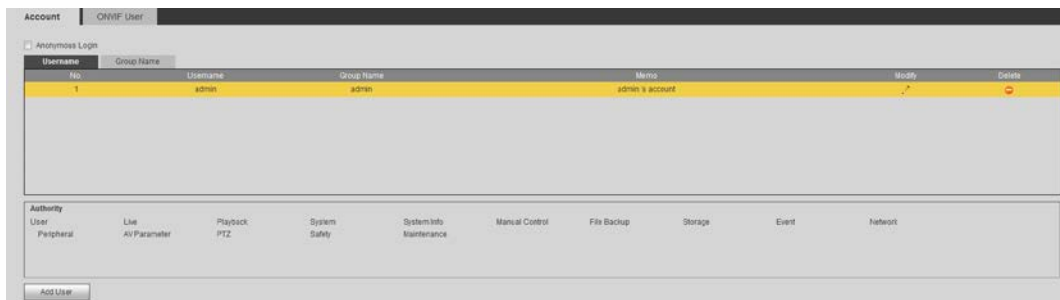

Step 2 Click .

The **Modify User** interface is displayed. See Figure 4-96.

Figure 4-96 Modify user (1)

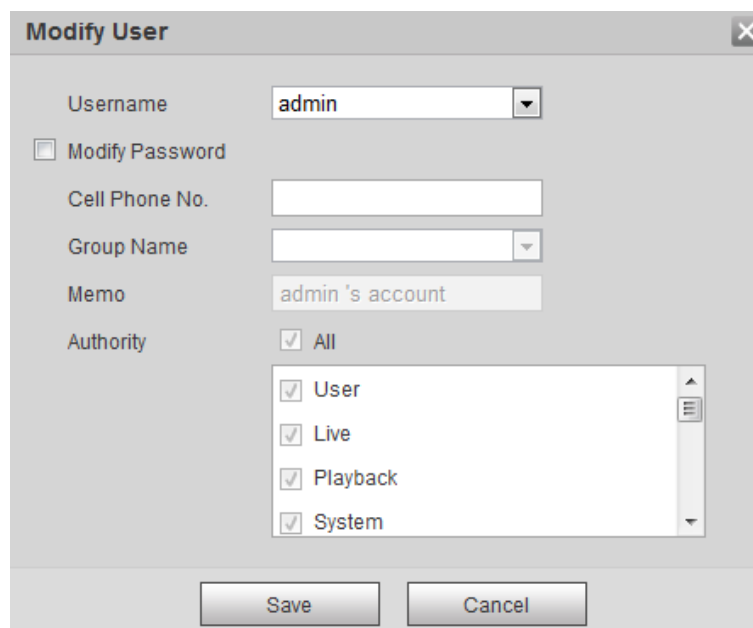

Step 3 Select the **Modify Password** check box.

More settings are displayed. See Figure 4-97.

Figure 4-97 Modify user (2)

Modify User

Username: admin

Modify Password

Old Password: []

New Password: []

The minimum pass phrase length is 8 characters

Weak Middle Strong

Confirm Password: []

Cell Phone No.: []

Group Name: []

Memo: admin 's account

Authority: All

- User
- Live
- Playback
- System

Save Cancel

Step 4 Type old password. Type new password and confirm it.



The password must have 8 to 32 digits and at the same time have at least two of the four types: capital letter, lowercase letter, number and special characters.

Step 5 Click **Save** to finish password modification.

4.8.3 Adding ONVIF User

Step 1 Select **Setting > System > Account > ONVIF User**.

The **ONVIF User** interface is displayed. See Figure 4-98.

Figure 4-98 ONVIF user

No.	Username	Group Name	Modify	Delete
1	admin	admin	[]	[]

Add User

Step 2 Click **Add User**.

The **Add User** interface is displayed. See Figure 4-99.

Figure 4-99 Add user

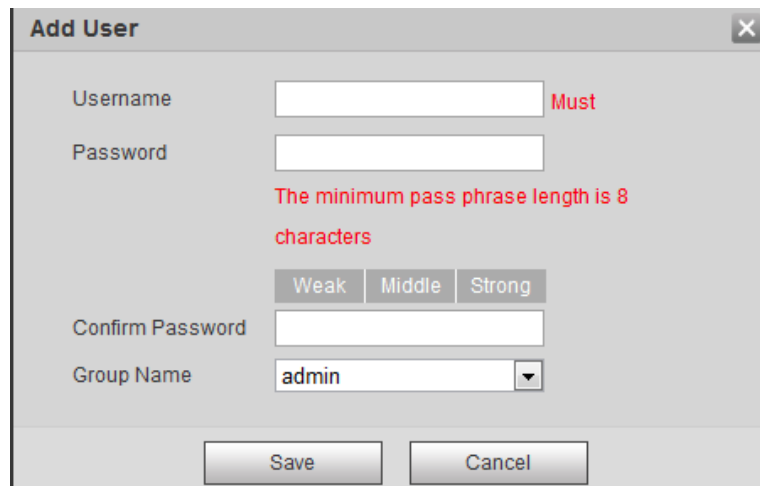

Step 3 Enter username, password and confirm the password. Then, select group name.

Step 4 Click **Save**.

4.8.4 Safety Management

Set RTSP authentication, IP filter, system service and HTTPS to secure data transmission and prevent data leakage.

4.8.4.1 Configuring RTSP Authentication

RTSP (Real Time Streaming Protocol) is to secure transmission of streaming media.

Step 1 Select **Setting > System > Security > RTSP Authentication**.

The **RTSP Authentication** interface is displayed. See Figure 4-100.

Figure 4-100 RTSP authentication

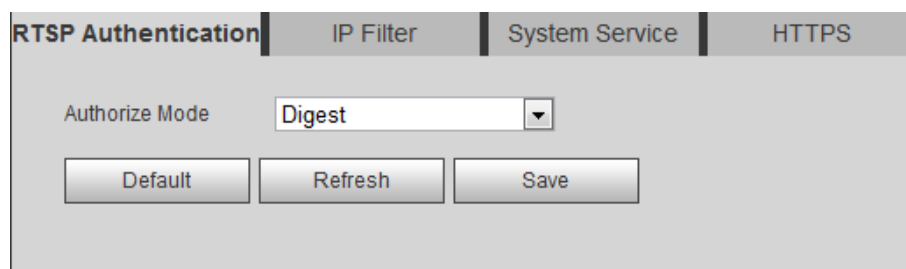

Step 2 Select an authentication mode.

Step 3 Click **Save**.

4.8.4.2 Configuring IP Filter

To secure the network environment and protect your data, you can use IP filter to set who can and who cannot access your Camera.

- Allowlist: Only users whose IP/MAC are on the allowlist can access your Camera.
- Banned list: Only users whose IP/MAC are on the banned list cannot access your Camera.
- Only when IP addresses of both your Camera and your PC are located in the same LAN, can MAC verification takes effect.



- When accessing through WAN, you can only use MAC of your router to limit MAC verification.
- You cannot enable allowlist and banned list at the same time.
- You cannot add your Camera IP/MAC to the allowlist.

Step 1 Select **Setting > System > Safety > IP Filter**.

The **IP Filter** interface is displayed. See Figure 4-101.

Figure 4-101 IP filter



Step 2 Select the check box of **Enable**.

- Add an IP/Mac address to the allowlist.
 - 1) Click the **Trusted Sites** tab.
The **Trusted Sites** interface is displayed.
 - 2) Click **Add IP/MAC**.
The dialogue box of **Add IP/MAC** is displayed.
 - 3) Set IP/MAC address. See Table 4-50.

Table 4-50 IP/MAC address parameters description (trusted sites)

Parameter	Description
IP address	IP address you are going to authorize.
IP segment	Start address and end address of the IP segment.
MAC address	MAC address you are going to authorize.

- 4) Click **Save**.
 - Add an IP/Mac address to the banned list.
 - 1) Click the **Banned List** tab.
The **Banned List** interface is displayed.
 - 2) Click **Add IP/MAC**.
The dialogue box of **Add IP/MAC** is displayed.
 - 3) Set IP/MAC address. See Table 4-51.

Table 4-51 IP/MAC address parameters description (banned list)

Parameter	Description
IP address	IP address you are going to prohibit.
IP segment	Start address and end address of the IP segment.
MAC address	MAC address you are going to prohibit.

- 4) Click **Save**.

Step 3 Click **Save**.

4.8.4.3 Configuring System Service

You can set functions such as SSH, password reset, CGI service, Onvif service, genetec service, audio and video transmission encryption and mobile push.

Step 1 Select **Setting > System > Safety > System Service**.

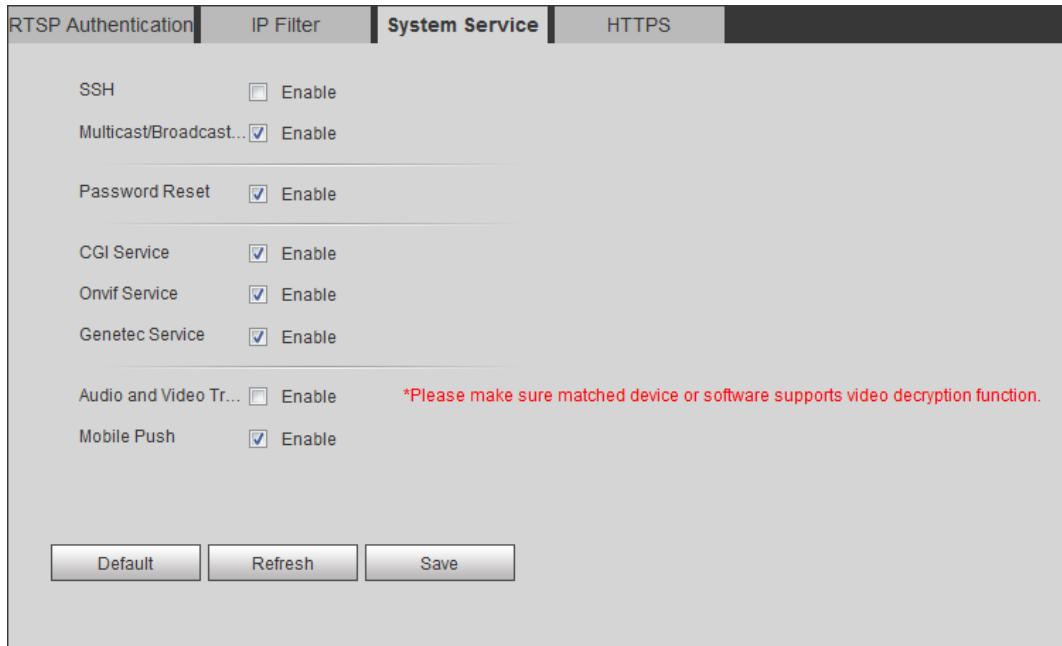

The **System Service** interface is displayed. See Figure 4-102.

Figure 4-102 System service



Step 2 Enable functions on the **System Service** interface. See Table 4-52.

Table 4-52 System service parameters description

Parameter	Description
SSH	Disabled by default. SSH (Secure Shell) can encode your data for its transmission. By this way, data leakage can be prevented when you manage your Camera remotely.
Password Reset	Enabled by default.  If you choose to disable this function, then you can only restore hardware to reset password.
CGI Service	Enabled by default. Enable CGI(Common Gateway Interface)and then you can use your browser to get data from the server.
Onvif Service	Enabled by default. Enable Onvif service to connect your Camera to network video products (front ends of both vidicons and video recorders, and video recorders included) by other manufacturers.
Genetec Service	Enabled by default.
Audio and Video Transmission Encryption	Disabled by default.  <ul style="list-style-type: none"> If you enable this function, ensure the matching Cameras or software can decode audio and video you have encoded. Transmission of audio and video between your Camera and the other platform cannot be encoded. So, for data security, we recommend you to disable CGI service and Onvif service.

Mobile Push	Enabled by default. Snapshots under alarm condition can be delivered to your phone.
-------------	---

Step 3 Click **Save**.

4.8.4.4 Configuring HTTPS

With HTTPS, you can install customized certificates or signed certificates. You can also obtain and install a root certificate.

After installing customized certificates or signed certificates to your Camera, you need to install a root certificate to your PC. By this, your PC will log in the Camera normally through HTTPS and guarantee your data security.

4.8.4.4.1 Creating and Installing Customized Certificates

Step 1 Select **Setup > Network > HTTPS**.

The **HTTPS** interface is displayed. See Figure 4-103.

Figure 4-103 HTTPS

Step 2 Create a certificate.

1) Click **Create**.

The dialog box of HTTPS is displayed. See Figure 4-104.

Figure 4-104 Certificate creating

- 2) Configure HTTPS parameters. See Table 4-53.

Table 4-53 Parameters description

Parameter	Description
Country	Abbreviation of a country. Limited to 2 capital letters.
IP or Domain Name	IP address or domain name of your Camera
Validity period	Validity period of the certificate.
Province	Province where you use this certificate.
Location	Location where you use this certificate.
Organization	Organization that uses this certificate.
Organization Unit	Name of organization unit that uses this certificate.
Email	Email of a person or a company who uses this certificate.

- 3) Click **Create**.

Requests created will be displayed.

Step 3 Click **Install** to start installation. After that, certificate property will be displayed in the **Certificate Installed** bar of the **HTTPS** interface.



Click **Delete** near the **Certificate Installed** bar of the **HTTPS** interface to delete an installed certificate.

Step 4 Click **Save** to store the root certificate.

Step 5 Install the root certificate.

- 1) Double-click  RootCert.cer you have saved.

The dialog box of **Certificate** is displayed. See Figure 4-105.

Figure 4-105 Certificate

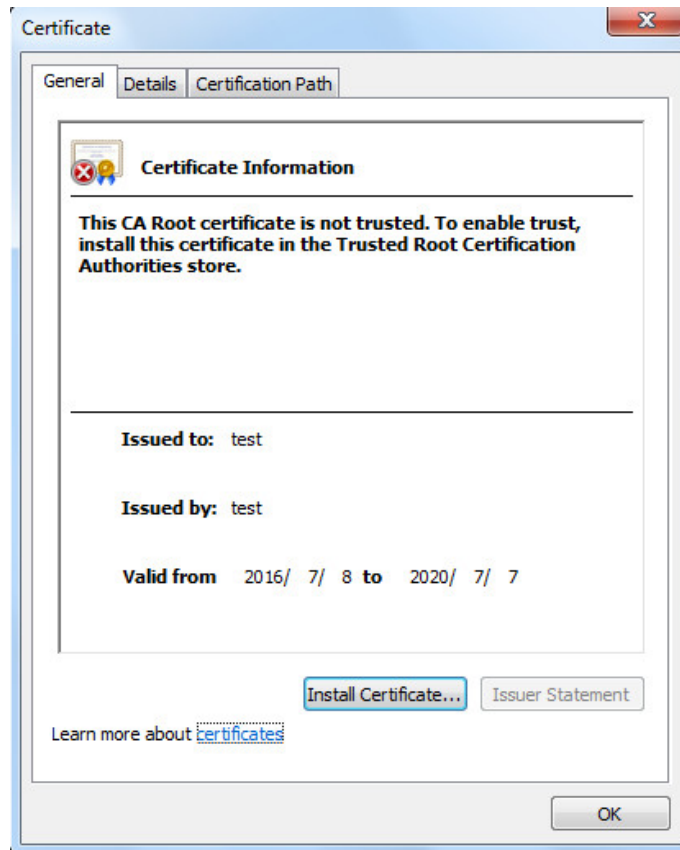

- 2) Click **Install Certificate**.

The **Certificate Import Wizard** interface is displayed. See Figure 4-106.

Figure 4-106 Certificate import wizard



- 3) Click **Next**.

The certificate store selection interface is displayed.

Figure 4-107 Certificate store

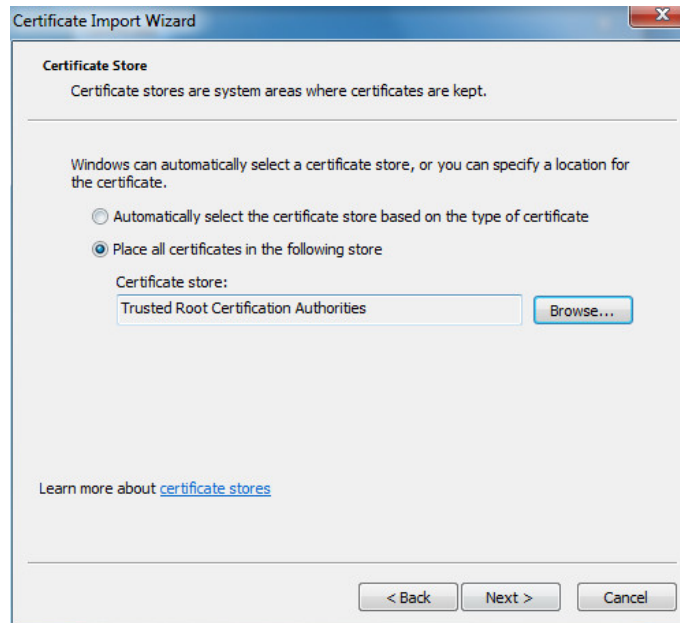

- 4) Select "Place all certificates in the following store." Click **Browse** and set the "Trusted Root Certification Authorities" as certificate store.
- 5) Click **Next**.

The certificate import completing wizard is displayed. See Figure 4-108.

Figure 4-108 Certificate import wizard completing

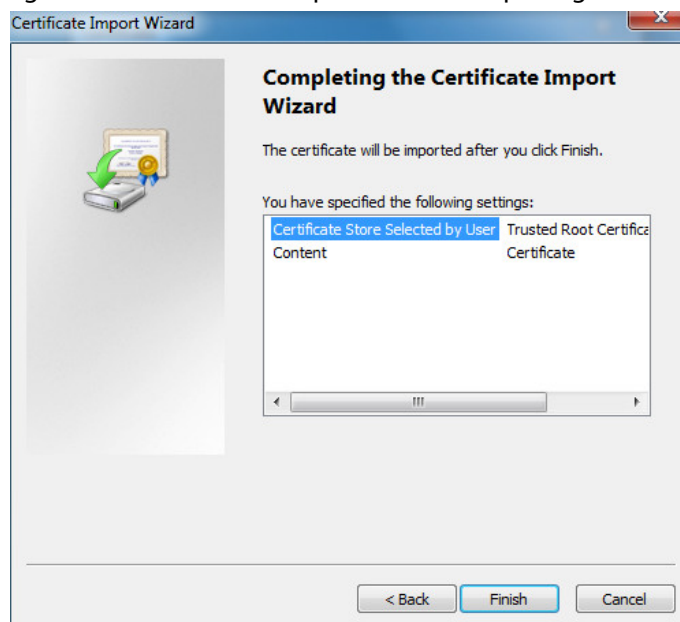

- 6) Click **Finish**.

The security warning interface is displayed. See Figure 4-109.

Figure 4-109 Security warning

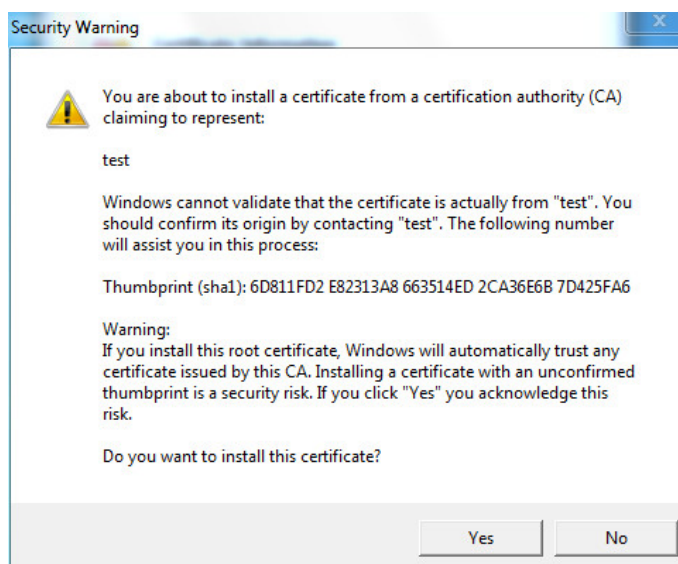

- 7) Click **Yes**.

The system pops up a message that indicates the import was successful. See Click **Save** to finish certificate importing.

Figure 4-110 Successful import prompt

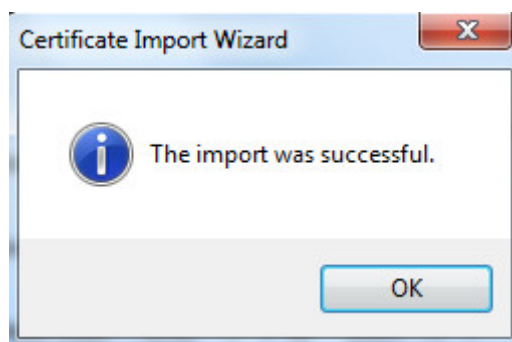

- 8) Click **Save** to finish installation of root certificate.

Step 6 Enable HTTPS and a prompt that the Camera needs to be rebooted is displayed.

After your Camera reboots, type IP address of the Camera in your browser and access the Camera through HTTPS protocol.

4.8.4.4.2 Installing Signed Certificate

Get a signed certificate and its password from the digital signature institute. And import the certificate and its password to the Camera.

Step 1 Select **Setting > Network > HTTPS**.

The **HTTPS** interface is displayed. See Figure 4-111.

Figure 4-111 HTTPS

The screenshot shows a web interface for configuring HTTPS. At the top, there are tabs for 'RTSP Authentication', 'IP Filter', 'System Service', and 'HTTPS'. Below the tabs, there is a checkbox labeled 'Enable HTTPS'. The interface is divided into several sections: 'Create Certificate' with a 'Create' button; 'Request Created' with a text input field and 'Delete', 'Install', and 'Download' buttons; 'Install Signed Certificate' with 'Certificate Path' and 'Certificate Key Path' text input fields, 'Browse...' buttons, and an 'Upload' button; and 'Certificate Installed' with a text input field and a 'Delete' button. At the bottom, there are 'Refresh' and 'Save' buttons.

Step 2 Install a certificate that has been signed.

- 1) Click **Browse** on the right side of **Certificate Path** bar to select a certificate you are to upload.
- 2) Click **Browse** on the right side of **Certificate Key Path** bar to select the certificate password you are to upload.

Step 3 Click **Upload**.

Installation begins. After that, certificate property will be displayed in the **Certificate Installed** bar of the **HTTPS** interface.



Click **Delete** near the **Certificate Installed** bar of the **HTTPS** interface to delete a certificate installed.

Step 4 Click **Save** to store the root certificate.

Step 5 Install the root certificate.

- 3) Click  RootCert.cer you have saved.

The dialog box of **Certificate** is displayed. See Figure 4-112.

Figure 4-112 Certificate

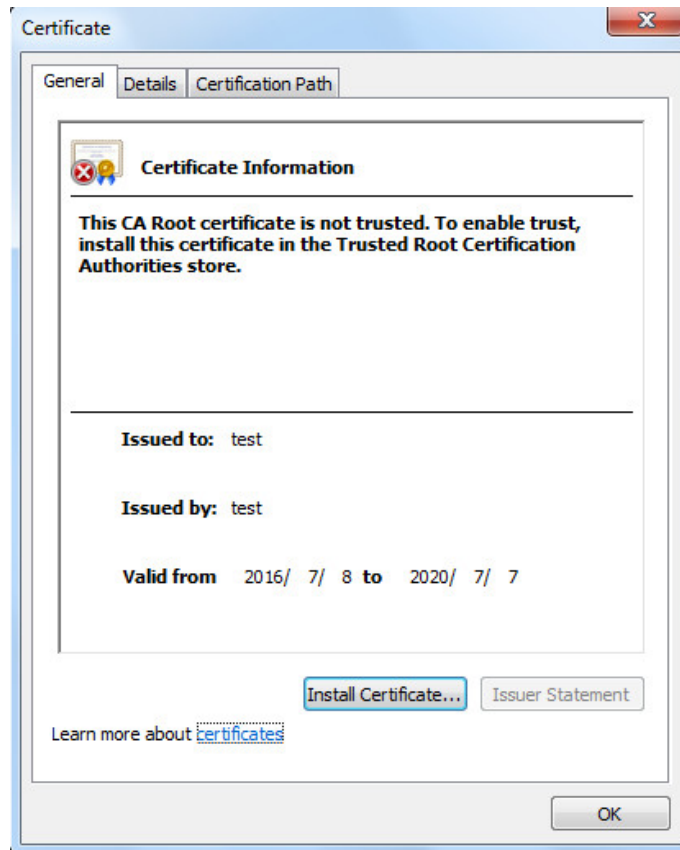

- 4) Click **Install Certificate**.

The **Certificate Import Wizard** interface is displayed. See Figure 4-113.

Figure 4-113 Certificate import wizard



- 5) Click **Next**.

The certificate store selection interface is displayed. See Figure 4-114.

Figure 4-114 Certificate store

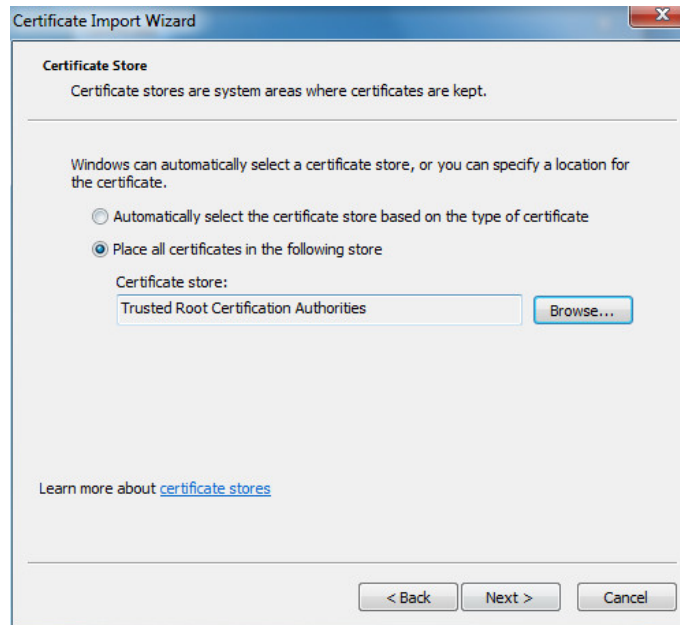

- 6) Select "Place all certificates in the following store." Click **Browse** and set the trusted root certificate authority as certificate store.
- 7) Click **Next**.

The certificate import completing wizard is displayed. See Figure 4-115.

Figure 4-115 Certificate import wizard completing

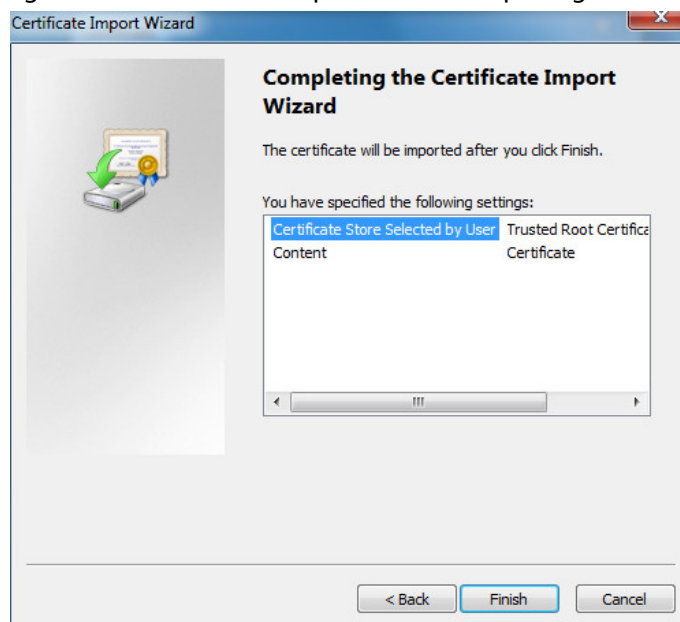

- 8) Click **Finish**.

The security warning interface is displayed. See Figure 4-116.

Figure 4-116 Security warning

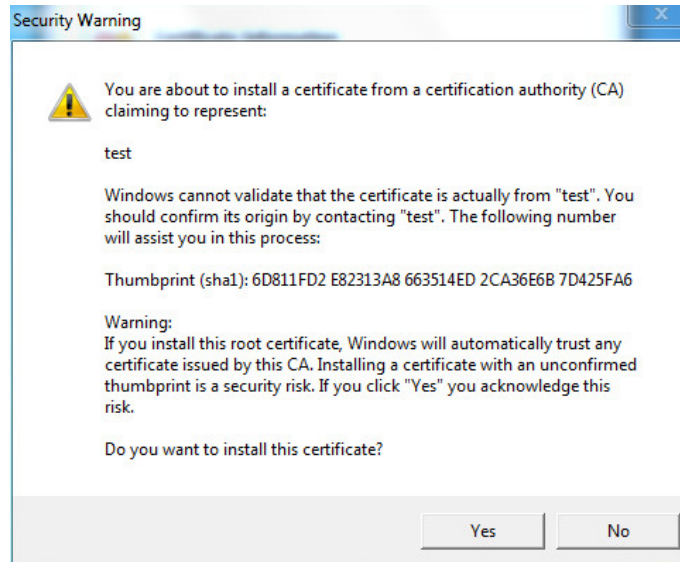

- 9) Click **Yes**.

The system pops up a message that indicates the import was successful. See Figure 4-117. Click **Save** to finish certificate importing.

Figure 4-117 Successful import prompt

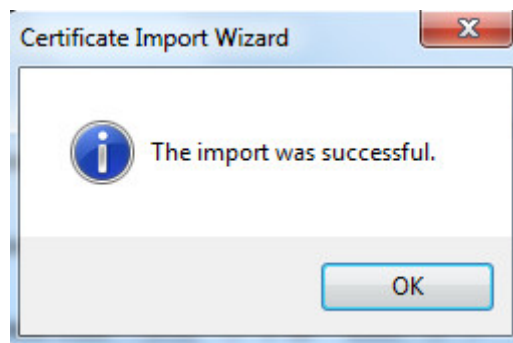

- 10) Click **Save** to finish installation of root certificate.

Step 6 Enable HTTPS and a prompt that the Camera needs to be rebooted is displayed.

After your Camera reboots, type IP address of the Camera in your browser and access the Camera through HTTPS protocol.

5 System Maintenance

5.1 Maintenance Requirements

For the system's good and safe running, it's recommended to manage and maintain the system, backup files with the following methods.

- Check surveillance images regularly.
- Clear regularly user and user group information that are not frequently used.
- Modify your password every 3 months.
- Check your system logbook regularly. Handle problems as soon as possible.
- Backup your configuration of system regularly.
- Regularly check your files and delete the old ones.
- Upgrade firmware regularly.

5.2 Auto Maintenance

You can configure settings such as "time of when to self-reboot" "rebooting Camera manually" and "deleting files automatically."

5.2.1 Rebooting Camera

Step 1 Select **Setting > System > Auto Maintain**.

The **Auto Maintain** interface is displayed. See Figure 5-1.

Figure 5-1 Auto maintain

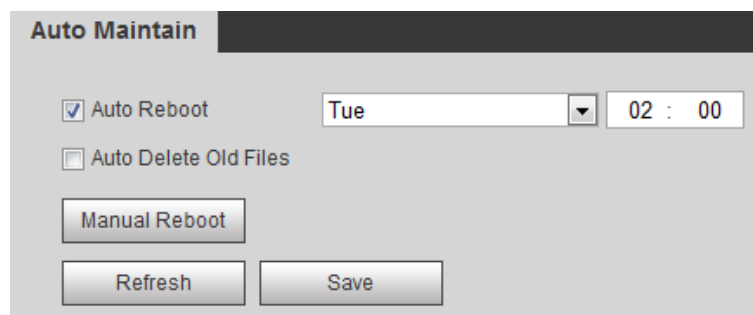

Step 2 Reboot this Camera.

- Auto reboot: Select **Auto Reboot** and set a reboot time you need. Then click **Save**.
- Manual reboot: Click **Manual Reboot** and a dialogue box is displayed. Click **Save** in this dialogue box and your Camera is rebooted at once.

5.2.2 Deleting Old Files

You can enable this function to delete recorded videos or images saved in SD card, FTP or NAS server regularly according to the time gap you have set.

Step 1 Select **Setting > System > Auto Maintain**.

The **Auto Maintain** interface is displayed. See Figure 5-2.

Figure 5-2 Auto maintain

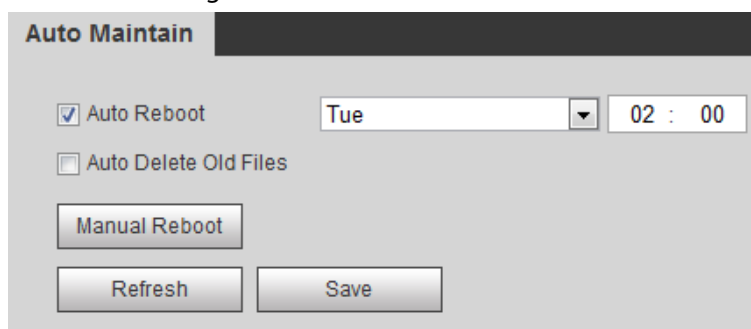

Step 2 Enable **Auto Delete Old Files** and select on your own the time gap of deleting the old files. Ranges from 1 to 31 day(s).

Step 3 Click **Save**.

5.3 Backing Up and Restoring

5.3.1 Importing and Exporting



Files that are exported do not contain presets. To import and export presets, see "3.2.1.4 Configuring Preset Backup" and "3.2.2.4 Configuring Preset Backup."

Step 1 Select **Setting > System > Import/Export**.

The **Import/Export** interface is displayed. See Figure 5-3.

Figure 5-3 Import/Export

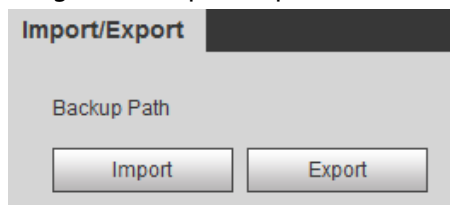

Step 2 Import/Export files.

- Click **Export** and paths of backing up files are displayed.
- Click **Import** to import files that you have exported and backed up.

5.3.2 Default Settings



Be careful when implementing operations such as "restored to default" and "restored to factory default". The operations will result in data loss.

Step 1 Select **Setting > System > Default**.

The **Default** interface is displayed. See Figure 5-4.

Figure 5-4 Default setting

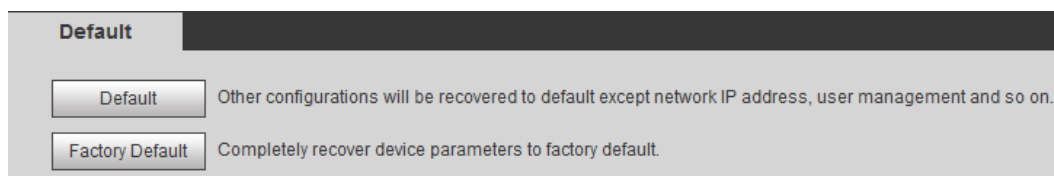

Step 2 Restore the Camera to default setting.

- Click **Default**, and all the configurations except IP Address and Account are reset.
- Click **Factory Default**, and all the configurations are reset.

5.4 Upgrading Firmware



- If a wrong upgrade file has been used, please reboot the Camera, otherwise some functions might not work properly.
- When upgrading, do not cut off power/network, reboot or turn off the Camera.

Step 1 Select **Setting > System > Upgrade**.

The **Upgrade** interface is displayed. See Figure 5-5.

Figure 5-5 Upgrade

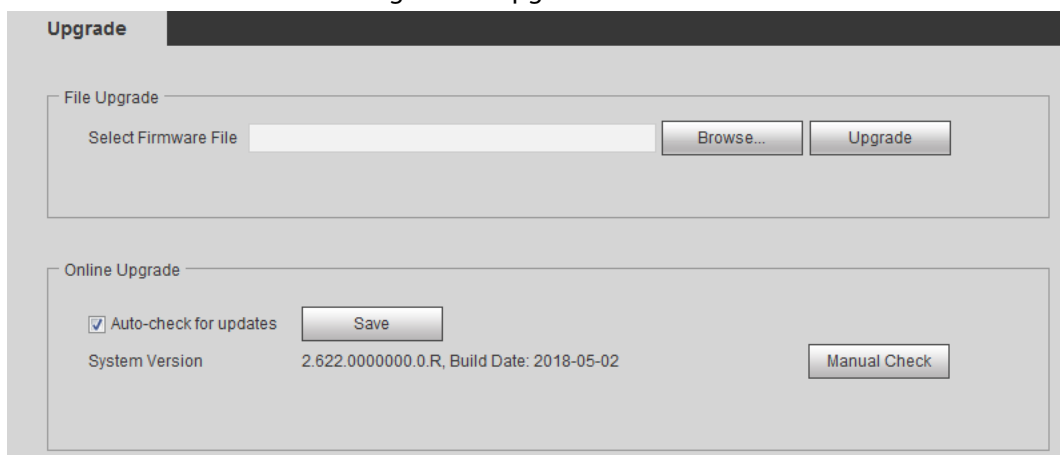

Step 2 Select an upgrading method you need and upgrade the system.

- File Upgrade
 - 1) Click **Browse**, and upload upgrade file.
The upgrade file should be a .bin file.
 - 2) Click **Upgrade** to start the process.
- Online Upgrade



Only when this thermal camera and your computer are both connected to network, can online upgrading be implemented.

Detect your system version.

- ◇ Auto detection: Select **Auto-check for updates** and click **Save**. The version is detected automatically.
- ◇ Manual detection: Select **Manual Check** and the system begins to check the version information.

5.5 Version Information

View Camera hardware information, system version and web version.



Versions of different Cameras might vary, and the actual product shall prevail.

Select **Setting > Information > Version**, and the **Version** interface is displayed. See Figure 5-6.

Figure 5-6 Version

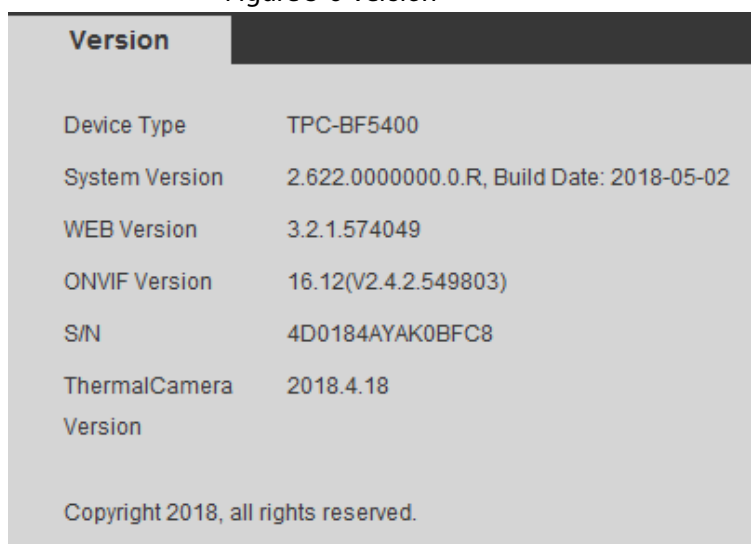

5.6 System Log

5.6.1 Searching System Logs

The log type includes "all, system, setting, data, event, record, account and safety."

Step 1 Select **Setting > Information > Log**.

The **Log** interface is displayed. See Figure 5-7.

Figure 5-7 Log

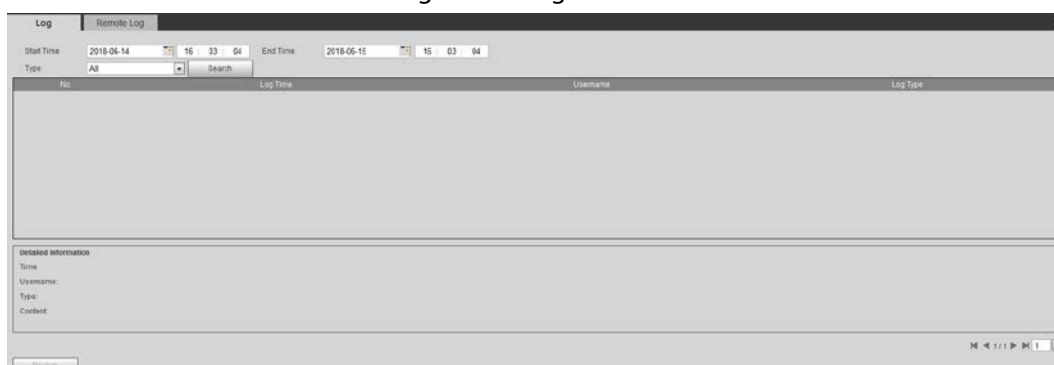

Step 2 Set start time and end time, and then select log type.

Table 5-1 Parameter description of system log

Parameters	Description
Start Time	Select a time period which you want to search.
End Time	The earliest start time is January 1, 2000, and the latest end time is December 31, 2037.

Type	<p>The log type includes "all, system, setting, data, event, record, account and safety."</p> <ul style="list-style-type: none"> • All: All log information. • System: Includes program launch, force exit, exit, program reboot, Camera turn off/reboot, system reboot and system upgrade. • Setting: Includes save configuration and delete configuration file. • Data: Includes configure disk type, erase data, hot swap, FTP state, NAS state, record mode, SD card error and hard disk error. • Event (Records events such as video detection, smart plan, alarm and abnormality): Includes event start and event end. • Record: Includes file access, file access error and file search. • User Management: Includes log in, log out, add user, delete user, modify user, add group, delete group and modify group. • Safety: Includes password reset and IP filter.
------	---

Step 3 Click **Search**.

The needed logs are displayed. See Figure 5-8.

- Click a log, and then you can view the detailed information in **Detailed Information** area.
- Click **Backup**, and then you can back up all the found logs to your PC.

Figure 5-8 Log information

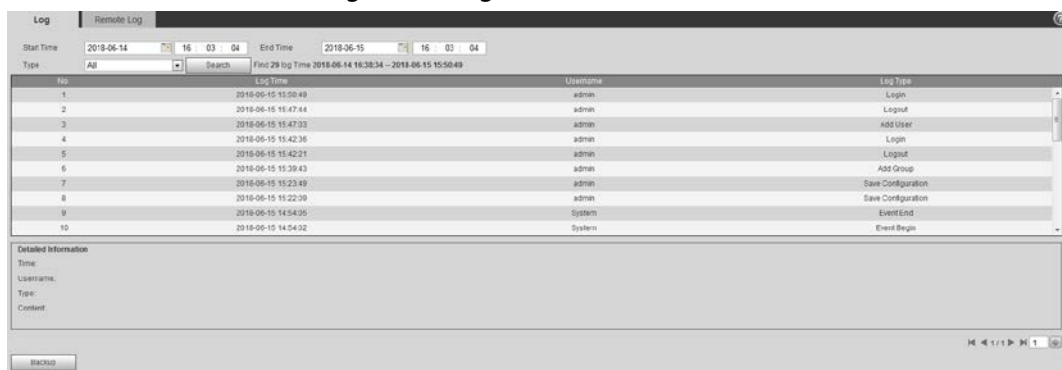

5.6.2 Remote View

Enable this function to remotely check logs in your Camera.

Step 1 Select **Setting > Information > Log**.

The **Remote Log** interface is displayed. See Figure 5-9.

Figure 5-9 Remote Log

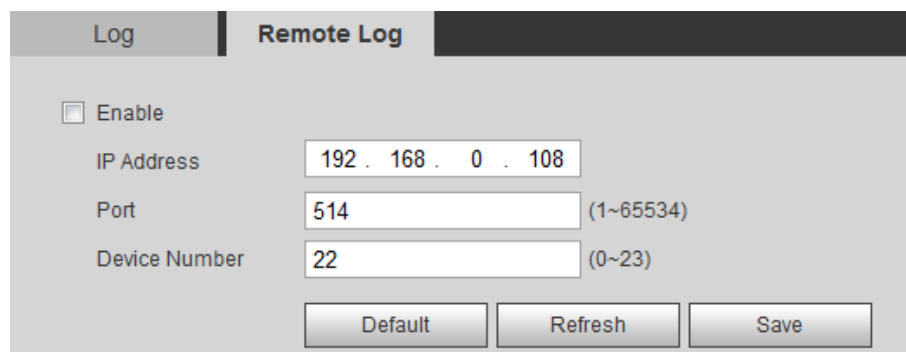

Step 2 Select the **Enable** check box.

Step 3 Set **IP Address**, **Port** and **Camera Number**. Then click **Save**.



You need to type remote computer's IP address here.

5.7 Online User

View all the current Web users.

Select **Setting > Information > Online User**, and the **Online User** interface is displayed. See Figure 5-10.

Figure 5-10 Online user

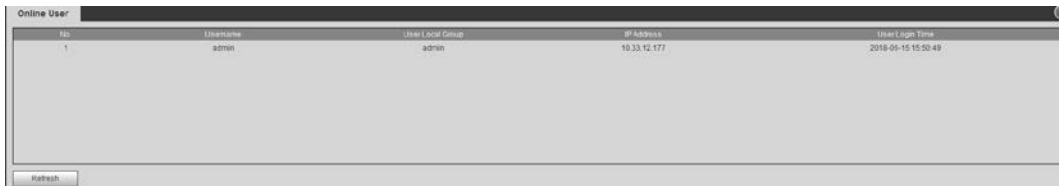

ID	Username	User Local Group	IP Address	User Login Time
1	admin	admin	10.33.12.177	2018-05-15 15:50:49

Refresh

6 Additional Accessing Methods

6.1 Accessing through NVR

Connect this camera to NVR (Network Video Recorder) through Wi-Fi or Ethernet. Then you can set and manage this camera through the NVR's web client.

Preparation

- Your PC, NVR and your thermal camera are all connected to network.
- You have enabled platform accessing function.
- You have logged in the NVR's web client.

Procedure

Step 1 Select **Setting > Camera > Registration**.

The **Remote Log** interface is displayed. See Figure 6-1.

Figure 6-1 Registration

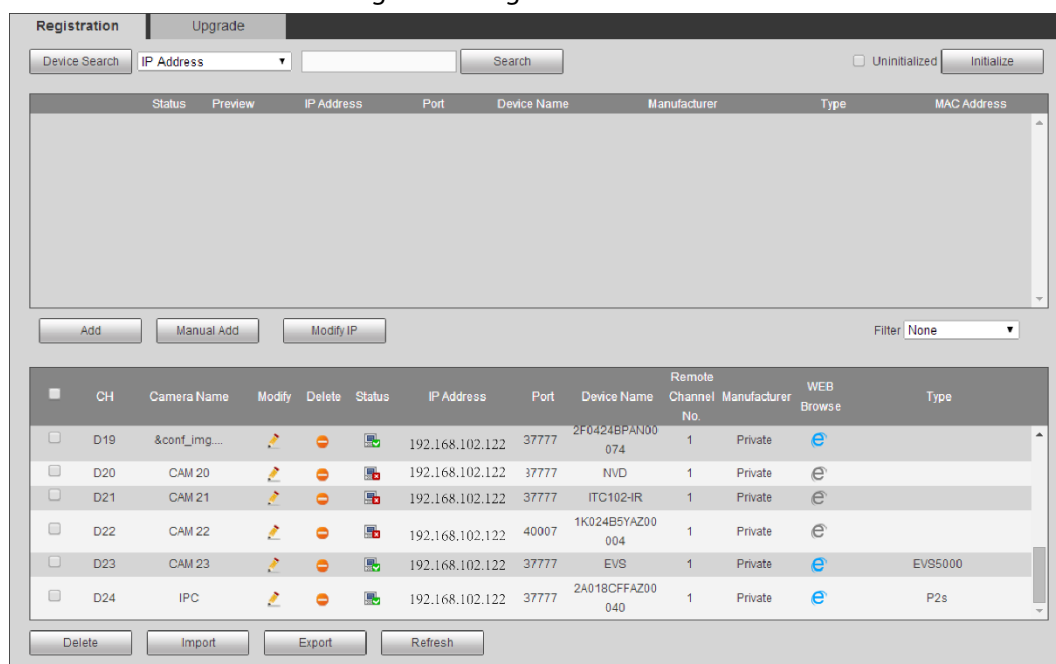

Step 2 Click **Search**.

After the search, the system displays Cameras that have been searched.

Step 3 Select Cameras whose IP address needs to be modified and click **Add**.

The following list will display information of tunnel with Cameras. When you log in the

Camera successfully, the connection condition displays .



Web client of NVR recognizes by default that username and password for logging in the Camera are both "admin." If you have modified your password, add your Camera manually.

6.2 Accessing through SmartPSS

You can set and manage this thermal camera through SmartPSS client.

Preparation

- You PC (with SmartPSS installed) and your thermal camera have been both connected to network.
- You have installed and opened SmartPSS.

Procedure

Step 1 Click **Cameras** in the homepage.

The **Cameras** interface is displayed. See Figure 6-2.

Figure 6-2 Camera list

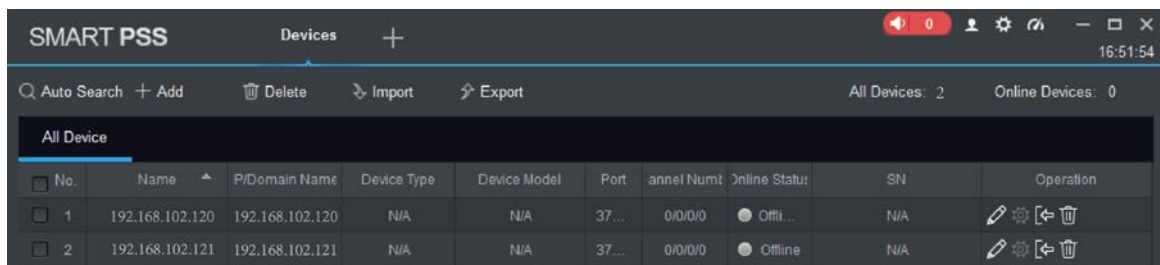

No.	Name	P/Domain Name	Device Type	Device Model	Port	annel Numt	Online Status	SN	Operation
1	192.168.102.120	192.168.102.120	N/A	N/A	37...	0/0/0/0	Offi...	N/A	[edit] [refresh] [delete]
2	192.168.102.121	192.168.102.121	N/A	N/A	37...	0/0/0/0	Offline	N/A	[edit] [refresh] [delete]

Step 2 Type the network segment the Camera is in, and then click **Search**.

After the search, the system displays Cameras that have been searched.

Step 3 Select Cameras whose IP address needs to be modified and click **Add**.

The following list will display Cameras that have been added. When you log in the Camera successfully, the connection condition displays **Online**.



It's set by default that username and password for logging in the client side of SmartPSS are both "admin." If you have modified the password or Camera port, please add Camera manually.

Appendix 1 Cybersecurity Recommendations

Cybersecurity is more than just a buzzword: it's something that pertains to every device that is connected to the internet. IP video surveillance is not immune to cyber risks, but taking basic steps toward protecting and strengthening networks and networked appliances will make them less susceptible to attacks. Below are some tips and recommendations on how to create a more secured security system.

Mandatory actions to be taken for basic equipment network security:

1. Use Strong Passwords

Please refer to the following suggestions to set passwords:

- The length should not be less than 8 characters;
- Include at least two types of characters; character types include upper and lower case letters, numbers and symbols;
- Do not contain the account name or the account name in reverse order;
- Do not use continuous characters, such as 123, abc, etc.;
- Do not use overlapped characters, such as 111, aaa, etc.;

2. Update Firmware and Client Software in Time

- According to the standard procedure in Tech-industry, we recommend to keep your equipment (such as NVR, DVR, IP camera, etc.) firmware up-to-date to ensure the system is equipped with the latest security patches and fixes. When the equipment is connected to the public network, it is recommended to enable the "auto-check for updates" function to obtain timely information of firmware updates released by the manufacturer.
- We suggest that you download and use the latest version of client software.

"Nice to have" recommendations to improve your equipment network security:

1. Physical Protection

We suggest that you perform physical protection to equipment, especially storage devices. For example, place the equipment in a special computer room and cabinet, and implement well-done access control permission and key management to prevent unauthorized personnel from carrying out physical contacts such as damaging hardware, unauthorized connection of removable equipment (such as USB flash disk, serial port), etc.

2. Change Passwords Regularly

We suggest that you change passwords regularly to reduce the risk of being guessed or cracked.

3. Set and Update Passwords Reset Information Timely

The equipment supports password reset function. Please set up related information for password reset in time, including the end user's mailbox and password protection questions. If the information changes, please modify it in time. When setting password protection questions, it is suggested not to use those that can be easily guessed.

4. Enable Account Lock

The account lock feature is enabled by default, and we recommend you to keep it on to guarantee the account security. If an attacker attempts to log in with the wrong password several times, the corresponding account and the source IP address will be locked.

5. Change Default HTTP and Other Service Ports

We suggest you to change default HTTP and other service ports into any set of numbers between 1024~65535, reducing the risk of outsiders being able to guess which ports you are using.

6. Enable HTTPS

We suggest you to enable HTTPS, so that you visit Web service through a secure communication channel.

7. Enable Allowlist

We suggest you to enable allowlist function to prevent everyone, except those with specified IP addresses, from accessing the system. Therefore, please be sure to add your computer's IP address and the accompanying equipment's IP address to the allowlist.

8. MAC Address Binding

We recommend you to bind the IP and MAC address of the gateway to the equipment, thus reducing the risk of ARP spoofing.

9. Assign Accounts and Privileges Reasonably

According to business and management requirements, reasonably add users and assign a minimum set of permissions to them.

10. Disable Unnecessary Services and Choose Secure Modes

If not needed, it is recommended to turn off some services such as SNMP, SMTP, UPnP, etc., to reduce risks.

If necessary, it is highly recommended that you use safe modes, including but not limited to the following services:

- SNMP: Choose SNMP v3, and set up strong encryption passwords and authentication passwords.
- SMTP: Choose TLS to access mailbox server.
- FTP: Choose SFTP, and set up strong passwords.
- AP hotspot: Choose WPA2-PSK encryption mode, and set up strong passwords.

11. Audio and Video Encrypted Transmission

If your audio and video data contents are very important or sensitive, we recommend that you use encrypted transmission function, to reduce the risk of audio and video data being stolen during transmission.

Reminder: encrypted transmission will cause some loss in transmission efficiency.

12. Secure Auditing

- Check online users: we suggest that you check online users regularly to see if the device is logged in without authorization.
- Check equipment log: By viewing the logs, you can know the IP addresses that were used to log in to your devices and their key operations.

13. Network Log

Due to the limited storage capacity of the equipment, the stored log is limited. If you need to save the log for a long time, it is recommended that you enable the network log function to ensure that the critical logs are synchronized to the network log server for tracing.

14. Construct a Safe Network Environment

In order to better ensure the safety of equipment and reduce potential cyber risks, we recommend:

- Disable the port mapping function of the router to avoid direct access to the intranet devices from external network.
- The network should be partitioned and isolated according to the actual network needs. If there are no communication requirements between two sub networks, it is suggested to use VLAN, network GAP and other technologies to partition the network, so as to achieve the network isolation effect.

- Establish the 802.1x access authentication system to reduce the risk of unauthorized access to private networks.
- It is recommended that you enable your device's firewall or blocklist and allowlist feature to reduce the risk that your device might be attacked.