



Wireless Door Detector

User's Manual







Foreword

General

This manual introduces the functions and operations of the wireless door detector (hereinafter referred to as the "door detector").

Safety Instructions

The following signal words might appear in the manual.

Signal Words	Meaning
 DANGER	Indicates a high potential hazard which, if not avoided, will result in death or serious injury.
 WARNING	Indicates a medium or low potential hazard which, if not avoided, could result in slight or moderate injury.
 CAUTION	Indicates a potential risk which, if not avoided, could result in property damage, data loss, reductions in performance, or unpredictable results.
 TIPS	Provides methods to help you solve a problem or save time.
 NOTE	Provides additional information as a supplement to the text.

Revision History

Revision Content	Release Time	Revision Content
V1.0.0	First release.	August 2021

Privacy Protection Notice

As the device user or data controller, you might collect the personal data of others such as their face, fingerprints, and car plate number. You need to be in compliance with your local privacy protection laws and regulations to protect the legitimate rights and interests of other people by implementing measures which include but are not limited: Providing clear and visible identification to inform people of the existence of the surveillance area and provide required contact information.

About the Manual

- The manual is for reference only. Slight differences might be found between the manual and the product.
- We are not liable for losses incurred due to operating the product in ways that are not in compliance with the manual.
- The manual will be updated according to the latest laws and regulations of related jurisdictions. For detailed information, see the paper user's manual, use our CD-ROM, scan the QR code or visit our official website. The manual is for reference only. Slight differences might be found between the electronic version and the paper version.

- All designs and software are subject to change without prior written notice. Product updates might result in some differences appearing between the actual product and the manual. Please contact customer service for the latest program and supplementary documentation.
- There might be errors in the print or deviations in the description of the functions, operations and technical data. If there is any doubt or dispute, we reserve the right of final explanation.
- Upgrade the reader software or try other mainstream reader software if the manual (in PDF format) cannot be opened.
- All trademarks, registered trademarks and company names in the manual are properties of their respective owners.
- Please visit our website, contact the supplier or customer service if any problems occur while using the device.
- If there is any uncertainty or controversy, we reserve the right of final explanation.

Important Safeguards and Warnings

This section introduces content covering the proper handling of the Device, hazard prevention, and prevention of property damage. Read carefully before using the Device, comply with the guidelines when using it, and keep the manual safe for future reference.

Operation Requirements



- Make sure that the power supply of the device works properly before use.
- Do not pull out the power cable of the device while it is powered on.
- Only use the device within the rated power range.
- Transport, use and store the device under allowed humidity and temperature conditions.
- Prevent liquids from splashing or dripping on the device. Make sure that there are no objects filled with liquid on top of the device to avoid liquids flowing into it.
- Do not disassemble the device.

Installation Requirements



- Connect the device to the adapter before power on.
- Strictly abide by local electrical safety standards, and make sure that the voltage in the area is steady and conforms to the power requirements of the device.
- Do not connect the device to more than one power supply. Otherwise, the device might become damaged.



- Observe all safety procedures and wear required protective equipment provided for your use while working at heights.
- Do not expose the device to direct sunlight or heat sources.
- Do not install the device in humid, dusty or smoky places.
- Install the device in a well-ventilated place, and do not block the ventilator of the device.
- Use the power adapter or case power supply provided by the device manufacturer.
- The power supply must conform to the requirements of ES1 in IEC 62368-1 standard and be no higher than PS2. Note that the power supply requirements are subject to the device label.
- Connect class I electrical appliances to a power socket with protective earthing.

Table of Contents

Foreword	I
Important Safeguards and Warnings	III
1 Introduction	1
2 Checklist	2
3 Design	3
3.1 Appearance	3
3.2 Dimensions	4
4 Connecting to the Hub	5
5 Installation	6
6 Door Detector Configuration	7
6.1 Configuring the Door Detector	7
6.2 Status	8

1 Introduction

Door detector is a wireless detector consisting of a sensor and a magnet that can send a signal to the hub and trigger an alarm when an armed door is opened. It can be set up via the DMSS app for iOS and Android phones.

2 Checklist

Figure 2-1 Checklist

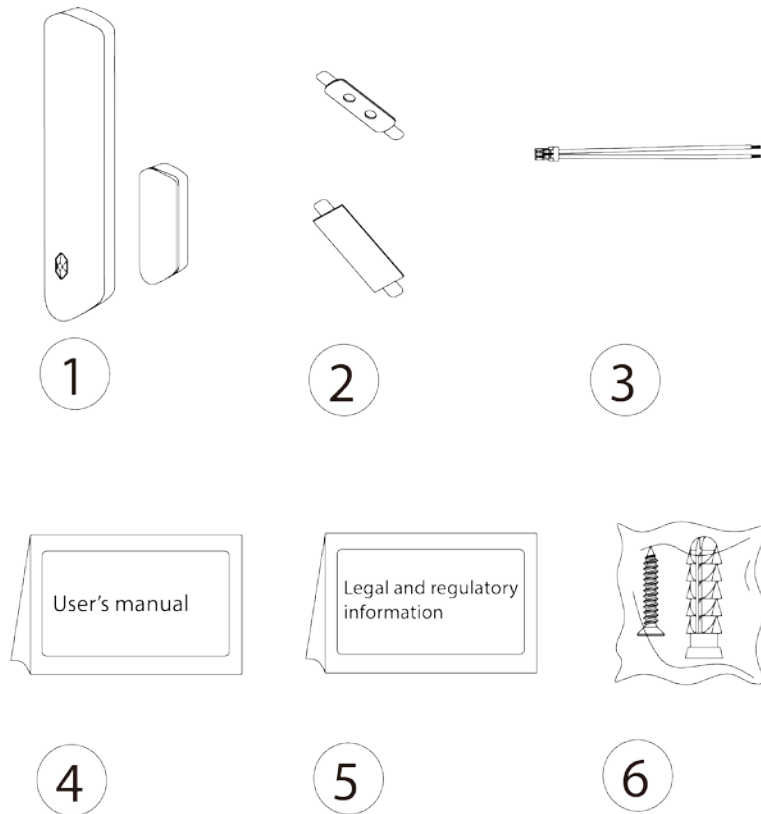

Table 2-1 Checklist

No.	Item Name	Quantity	No.	Item Name	Quantity
1	Door detector	1	4	User's manual	1
2	Double-sided adhesive tape	1	5	Legal and regulatory information	1
3	Cable	1	6	Screw package	2

3 Design

3.1 Appearance

Figure 3-1 Appearance

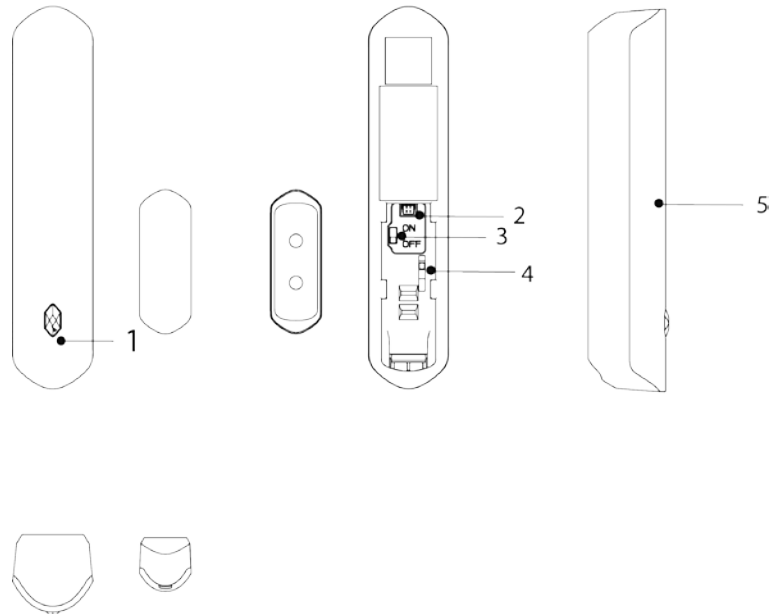
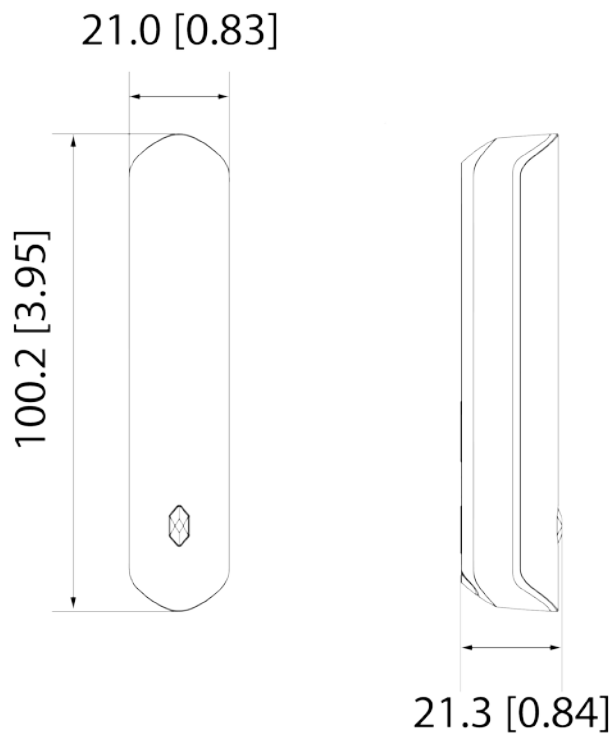

Table 3-1 Structure

No.	Name	Description
1	Indicator	<ul style="list-style-type: none"> Flashes green quickly: Pairing mode. Solid green: Alarm event is triggered.
2	Peripheral port	Connect the peripheral with the alarm cable.
3	On/Off button	Turn on or turn off the door detector.
4	Tamper button	When the tamper button is released, the tamper alarm will be triggered.
5	Lid	<ul style="list-style-type: none"> Normal status: Lid closed. Abnormal status: Lid open.

3.2 Dimensions

Figure 3-2 Dimensions (mm [inch])



4 Connecting to the Hub

Prior to connection with the hub, install the DMSS app on your phone. Make sure that you have installed the latest version of the app. This manual uses iOS as an example.



- Make sure that you have already created an account, and added hub to the DMSS.
- Make sure that the hub has stable internet connection.
- Make sure that the hub is disarmed.

Step 1 Go to the hub interface, and then tap  to add the detector.

Step 2 Tap  to scan the QR code at the bottom of the door detector, and then tap **Next**.

Step 3 Tap **Next** after the door detector has been found.

Step 4 Follow on-screen instructions and switch the door detector to on, and then tap **Next**.

Step 5 Wait for the pairing.

Step 6 Customize the name of the door detector and select the area, and then tap **Completed**.

5 Installation

Prior to installation, connect the door detector to the hub and check the signal level at the installation location. We recommend installing the door detector in a place with the signal strength of at least 2 bars.



- We recommend installing the door detector with expansion screws.
- Make sure to align  of the magnet with that of the door detector during installation, otherwise normal use of the door detector might be affected.

Figure 5-1 Installation

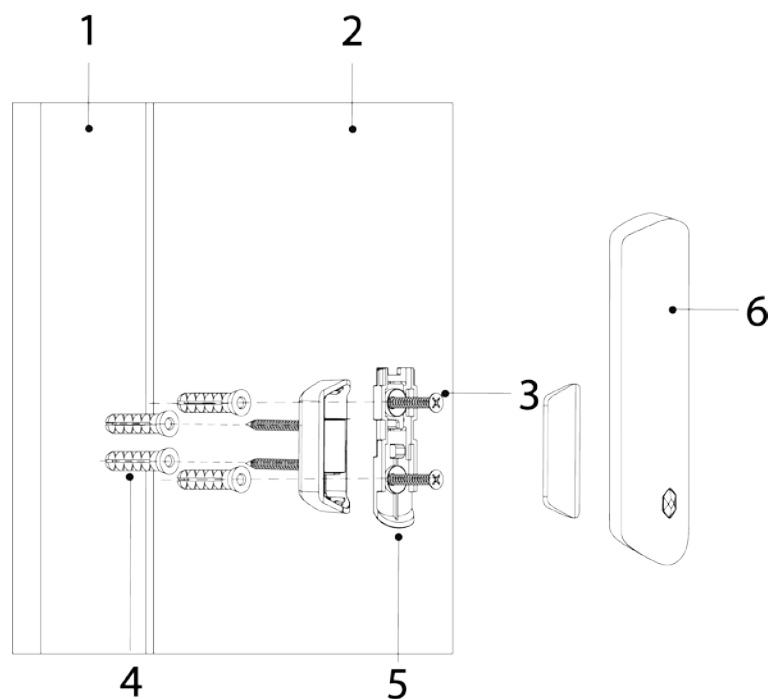

Table 5-1 Installation items

No.	Item name	No.	Item name
1	Door 1	4	Expansion bolt
2	Door 2	5	Attachment panel
3	ST3 × 18 mm self-tapping screw	6	Magnet

Step 1 Drill 4 holes in door 1 and door 2 according to the hole positions of the attachment panels.

Step 2 Put the expansion bolts into the holes.

Step 3 Align the screw holes on the plate with the expansion bolts.

Step 4 Fix the attachment panels with ST3 × 18 mm self-tapping screws.

Step 5 Put the door detector into the attachment panel from top to bottom.



6 Door Detector Configuration

You can view and edit general information of the door detector.

6.1 Configuring the Door Detector

On the **Hub** interface, select the door detector from the accessory list, and then you can configure the parameters of the door detector.

Table 6-1 Door detector parameter description

Parameter	Description
Device Configuration	<ul style="list-style-type: none"> View device name, type, SN and device model. Edit device name, and then tap Save to save configuration.
Area	Select the area to which the door detector is assigned.
24 H Protection Zone	The accessory located in the 24 h protection zone is always active whether the security system is configured in the armed mode or not.
Home Mode	Enable the home mode, and then the selected accessories under the hub will be armed.
Delay Mode under Home Mode	<p>Enable the Delay Mode under Home Mode, the selected accessory under the hub will be armed and the alarm will not be triggered until the end of customized delay time.</p> <p> Only enable Home Mode first can Delay Mode under Home Mode take effect.</p>
Delay Time	<ul style="list-style-type: none"> The system provides you with time to leave or enter the armed zone without alarm. Select from 0 s to 120 s. <p> The arming mode will be effective after the delay time.</p>
External Detector Access	Connect the wired peripheral with the cable.
Alarm-speaker Linkage	When an alarm is triggered, the accessories will report the alarm events to the hub and alert with siren.
Alarm-video Linkage	When an alarm is triggered, the accessories will report the alarm events to the hub and then will link events.
Video Channel	Select the video channel as needed.
Signal Strength Detection	Test the current signal strength.
Detector Test	Detect whether the accessory works.

Parameter	Description
Transmit Power	<ul style="list-style-type: none"> Select from high, low, and automatic. The higher the transmission power, the farther the transmission and the higher power consumption.
Cloud Update	Update online.
Delete	Delete the online accessory.  Go to the Hub interface, select the accessory from the list, and then swipe left to delete it.

6.2 Status















On the **Hub** interface, select the door detector as needed from the accessory list, and then tap  to view the status of the door detector.

Table 6-2 Status

Parameter	Value
Temperature	The temperature of the environment.
Signal Strength	The signal strength between the hub and the door detector. <ul style="list-style-type: none"> : Low. : Weak. : Good. : Excellent. : No.
Battery Level	The battery level of the detector. <ul style="list-style-type: none"> : Fully charged. : Sufficient. : Moderate. : Insufficient. : Low.
Anti-tampering Status	Anti-tampering status of the door detector.
Online Status	Online and offline status of the door detector. <ul style="list-style-type: none"> : Online. : Offline.
Entrance Delay Time	Entrance and exit delay time.
Exit Delay Time	
Door Status	Open or close status of the door. <ul style="list-style-type: none"> : Open. : Closed.

Parameter	Value
24 H Protection Zone Status	Active status of the 24 h protection zone. <ul style="list-style-type: none"><li data-bbox="667 293 852 322">● <input checked="" type="checkbox"/> 24: Enabled.<li data-bbox="667 333 852 362">● <input type="checkbox"/> 24: Disabled.
Program Version	The program version of the door detector.

ENABLING A SAFER SOCIETY AND SMARTER LIVING

ZHEJIANG DAHUA VISION TECHNOLOGY CO., LTD.

Address: No.1199 Bin'an Road, Binjiang District, Hangzhou, P. R. China | Website: www.dahuasecurity.com | Postcode: 310053

Email: overseas@dahuatech.com | Fax: +86-571-87688815 | Tel: +86-571-87688883