

VTM24P3

Panel



VTM24P3

Technical Specification

General

Model	VTM24P3
Color	Black
Dimensions	140mm×340.40mm×7.0mm(5.51"×13.40"×0.28")
Material	Aluminum

Ordering Information

Model	Description
VTM24P3	3-modular panel, used with VTM128, and applicable to VTO4202FB series

Dimensions (mm[inch])

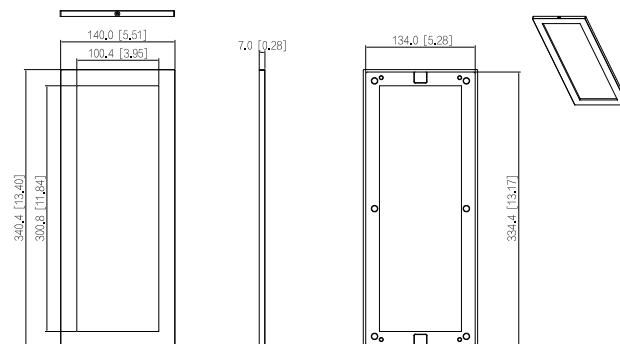

VTM24P3