

# **HDCVI Camera**

## **User Manual**







# Foreword

## General

This manual introduces the functions and operations of the HDCVI camera (hereinafter referred to as "the device"). Read carefully before using the device, and keep the manual safe for future reference.

## Safety Instructions

The following signal words might appear in the manual.

Signal Words	Meaning
 DANGER	Indicates a high potential hazard which, if not avoided, will result in death or serious injury.
 WARNING	Indicates a medium or low potential hazard which, if not avoided, could result in slight or moderate injury.
 CAUTION	Indicates a potential risk which, if not avoided, could result in property damage, data loss, reductions in performance, or unpredictable results.
 TIPS	Provides methods to help you solve a problem or save time.
 NOTE	Provides additional information as a supplement to the text.

## Revision History

Version	Revision Content	Release Time
V1.0.7	<ul style="list-style-type: none"><li>Added Linkage Tracking.</li><li>Updated FAQ.</li></ul>	October 2025
V1.0.6	Added Splicing Mode & Manual Linkage.	February 2025
V1.0.5	<ul style="list-style-type: none"><li>Updated Important Safeguards and Warnings.</li><li>Added PT Preset.</li><li>Updated FAQ.</li></ul>	August 2024
V1.0.4	Updated Transmission Distance.	June 2024
V1.0.3	Added PT Camera.	May 2023
V1.0.2	<ul style="list-style-type: none"><li>Added Smart Dual Illuminators Cameras Configuration.</li><li>Added Configuring Smart Dual Illuminators Active Deterrence Camera.</li></ul>	August 2022
V1.0.1	<ul style="list-style-type: none"><li>Adjusted the format of tables.</li><li>Added Cybersecurity Recommendations.</li></ul>	August 2021
V1.0.0	First release.	June 2020

## Privacy Protection Notice

As the device user or data controller, you might collect the personal data of others such as their face, audio, fingerprints, and license plate number. You need to be in compliance with your local privacy protection laws and regulations to protect the legitimate rights and interests of other people by implementing measures which include but are not limited to: Providing clear and visible identification to inform people of the existence of the surveillance area and provide required contact information.

## About the Manual

- The manual is for reference only. Slight differences might be found between the manual and the product.
- We are not liable for losses incurred due to operating the product in ways that are not in compliance with the manual.
- The manual will be updated according to the latest laws and regulations of related jurisdictions. For detailed information, see the paper user manual, use our CD-ROM, scan the QR code or visit our official website. The manual is for reference only. Slight differences might be found between the electronic version and the paper version.
- All designs and software are subject to change without prior written notice. Product updates might result in some differences appearing between the actual product and the manual. Please contact customer service for the latest program and supplementary documentation.
- There might be errors in the print or deviations in the description of the functions, operations and technical data. If there is any doubt or dispute, we reserve the right of final explanation.
- Upgrade the reader software or try other mainstream reader software if the manual (in PDF format) cannot be opened.
- All trademarks, registered trademarks and company names in the manual are properties of their respective owners.
- Please visit our website, contact the supplier or customer service if any problems occur while using the device.
- If there is any uncertainty or controversy, we reserve the right of final explanation.

# Important Safeguard and Warnings

This section introduces content covering the proper handling of the device, hazard prevention, and prevention of property damage. Read carefully before using the device, and comply with the guidelines when using it.

## Transportation Requirements



- Transport the device under allowed humidity and temperature conditions.
- Do not place heavy stress on the device, violently vibrate or immerse it in liquid during transportation.
- Pack the device with packaging provided by its manufacturer or packaging of the same quality before transporting it.

## Storage Requirements



- Store the device under allowed humidity and temperature conditions.
- Do not place heavy stress on the device, violently vibrate or immerse it in liquid during storage.

## Installation Requirements



- Strictly comply with the local electrical safety code and standards, and check whether the power supply is correct before operating the device.
- The power supply must conform to the requirements of ES1 in IEC 62368-1 standard and be no higher than PS2. Note that the power supply requirements are subject to the device label.
- Make sure that the power adapter meets the device operating voltage requirement before powering up the device (The material and length of the power cable might influence the device voltage).



- Do not place heavy stress on the device, violently vibrate or immerse it in liquid during installation.
- An emergency disconnect device must be installed during installation and wiring at a readily accessible location for emergency power cut-off.
- We assume no liability or responsibility for all the fires or electrical shock caused by improper handling or installation.
- We recommend you use the device with a lightning protection device for stronger protection against lightning. For outdoor scenarios, strictly comply with the lightning protection regulations.
- Ground the device to protective ground before you power it on.
- Use qualified video transmission cable to improve video quality, and use RG59 coaxial cable or higher standard.

## Operating Requirements



- Do not connect the device to more than one power supply. Otherwise, the device might be damaged.
- PoC supply voltage is up to 52 V. Do not dismantle the device during normal operation; otherwise it might cause danger to both device and users due to high voltage.
- If PoC power supply is used, do not connect any other device between the device and PoC transceiver including UTC, Balun, optical transceiver, distributor and convertor and so on; otherwise, the device might get burned.



- Use the device under allowed humidity and temperature conditions.
- Protect the line cord and wires from being walked on or squeezed particularly at plugs, power sockets, and the point where they exit from the device.
- Do not aim the device at strong light sources (such as lamplight, and sunlight) when focusing it, to avoid reducing the lifespan of the CMOS sensor, and causing overbrightness and flickering.
- When using a laser beam device, avoid exposing the device surface to laser beam radiation.
- Prevent liquid from flowing into the device to avoid damage to its internal components.
- Do not block the ventilation opening near the device to avoid heat accumulation.

## Maintenance Requirements



Use the accessories suggested by the manufacturer. Installation and maintenance must be performed by qualified professionals.

# Table of Contents

Foreword.....	I
Important Safeguard and Warnings.....	III
1 Overview.....	1
1.1 Introduction.....	1
1.2 Application.....	1
1.3 Transmission Distance.....	2
2 Cable Connection.....	3
2.1 Power Output.....	3
2.2 12 VDC Power Input Port.....	3
2.3 24 VAC Power Input Port.....	3
2.4 Video Output Port.....	4
2.5 Audio Input Port.....	4
2.6 Alarm Output Port.....	4
2.7 DIP Switch.....	4
2.8 HD/SD Switch Control Cable.....	5
2.9 HDCVI Aviation Connector.....	5
3 General Configuration and Operation.....	7
3.1 Entering XVR Main Menu.....	7
3.2 Setting Audio Input.....	7
3.3 Operating PTZ Control Panel.....	8
3.3.1 Operating OSD Menu.....	9
3.3.2 Operating Auto Focus (AF).....	10
4 Full-Color Camera Configuration.....	12
4.1 Enabling/Disabling Smart Light.....	12
4.2 Configuring Smart Light Adjustment.....	12
5 Smart Dual Illuminators Cameras Configuration.....	13
6 PT Camera Configuration.....	15
6.1 PTZ Control.....	15
6.2 PT Reset.....	15
6.3 PT Preset.....	16
6.4 Splicing Mode & Manual Linkage.....	17
6.5 Linkage Tracking.....	19
7 Active Deterrence Camera Configuration.....	21
7.1 Detection Range of PIR Detector.....	21
7.2 Configuring Trigger Mode.....	21
7.3 Configuring Light Warning and Audio Alarm.....	22
7.4 Configuring Smart Dual Illuminators Active Deterrence Camera.....	22

<b>8 Box Camera Installation.....</b>	<b>25</b>
<b>8.1 Lens Installation.....</b>	<b>25</b>
8.1.1 Installing Lens Type 1.....	25
8.1.2 Installing Lens Type 2.....	26
<b>8.2 I/O Port Installation.....</b>	<b>26</b>
8.2.1 Connecting Cable.....	27
8.2.2 Removing Cable.....	27
<b>8.3 Device Installation.....</b>	<b>28</b>
<b>9 Fisheye Camera Configuration.....</b>	<b>30</b>
9.1 Fisheye Dewarp on the Live Page.....	30
9.2 Fisheye Dewarp During Playback.....	31
<b>10 FAQ.....</b>	<b>32</b>
10.1 Flicker.....	32
10.2 PoC Power Supply.....	32
10.3 Long Distance Power Supply.....	33
10.4 Centralized Power Supply.....	33
10.5 Connector Waterproof Protection.....	34
<b>11 Maintenance.....</b>	<b>36</b>
<b>Appendix 1 Security Recommendation.....</b>	<b>37</b>

# 1 Overview

## 1.1 Introduction

The devices comply with the HDCVI standard and support the transmission of video and control signal over coaxial cable. The devices produce video signal with megapixel resolution and require connected XVRs to achieve high-speed, long-distance, and zero-lag transmission of the signal. They are applicable to various scenes, such as roads, warehouses, underground parking lots, bars, pipelines, and gas stations.

## 1.2 Application

Figure 1-1 Application scenario

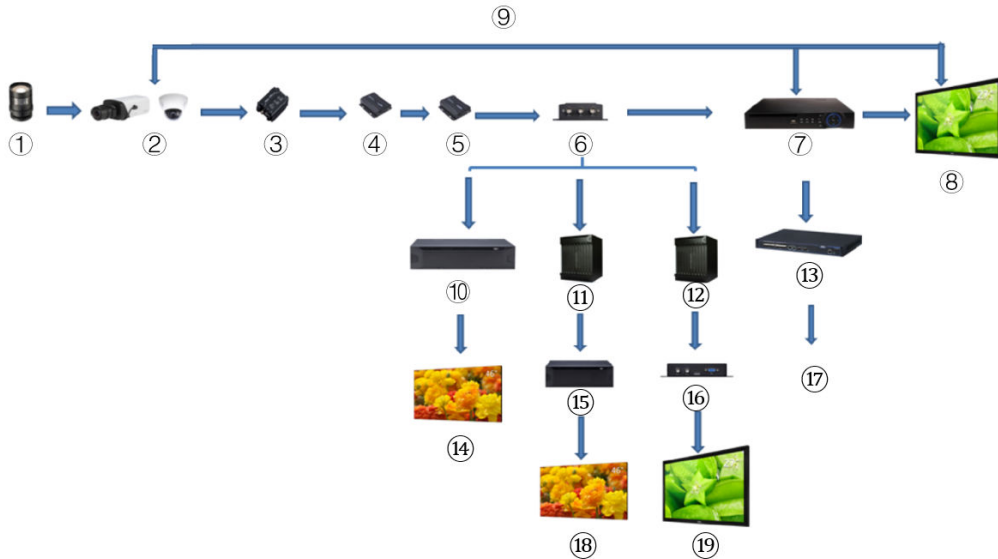

Table 1-1 Description of the application

No.	Name	No.	Name	No.	Name
1	(Optional) Lens	8	Display Screen	15	Splicer
2	HDCVI Products	9	Direct Connection	16	Convertor
3	(Optional) Surge Protection Device	10	Integrated Video Platform	17	Ethernet
4	(Optional) Optical Transceiver (Send)	11	Matrix	18	Splicing Screen
5	(Optional) Optical Transceiver (Receive)	12	Matrix	19	Display Screen
6	(Optional) Distributor	13	Switch	—	—
7	HCVR Products	14	Splicing Screen	—	—



## 1.3 Transmission Distance

Table 1-2 Transmission distance

Cable		720P	1080P	4MP/4K
Coaxial Cable	RG6 (75-5)	1200 m	800 m	700 m
	RG59 (75-3)	800 m	500 m	500 m
UTP	CAT6	450 m	300 m	300 m

## 2 Cable Connection



Cable types might vary with different cameras. Please refer to the actual product.

### 2.1 Power Output

Supplies 12 VDC power.



- Ensure that power consumption of devices connected to this port is below 2 W.
- Ensure that supply frequency of devices connected to this port is higher than 1 MHz, such as sound pick-up, temperature/humidity sensor and other devices without power consumption change. It might cause image flickering if this port is connected to devices with supply frequency less than 1 MHz, such as fan, hall sensor, loudspeaker, motor and other electromechanical devices with power consumption change.

Figure 2-1 Power output

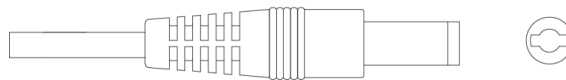

### 2.2 12 VDC Power Input Port

Inputs 12 VDC power.



Device abnormality or damage could occur if power is not supplied correctly for 12 VDC power input port. Be sure to supply power as instructed in the manual.

Figure 2-2 12 VDC power input port

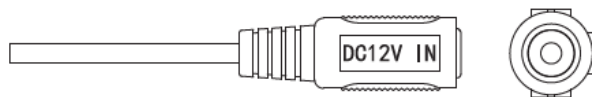

### 2.3 24 VAC Power Input Port

Inputs 24 VAC power.



Device abnormality or damage could occur if power is not supplied correctly. Please be sure to supply power as instructed in the manual.

Figure 2-3 24 VAC power input port

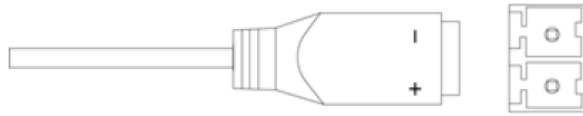

## 2.4 Video Output Port

Connects to the XVR to output video signal.

### WARNING

- When the device is in the condition of PoC power supply, do not connect any other device between the device and PoC XVR or PoC transceiver including UTC, Balun, optical transceiver, distributor and convertor and so on; otherwise, the device might get burned.
- PoC power supply is with high voltage. Do not dismantle the device during normal operation; otherwise it might cause danger to both device and users due to high voltage.

Figure 2-4 Video output port

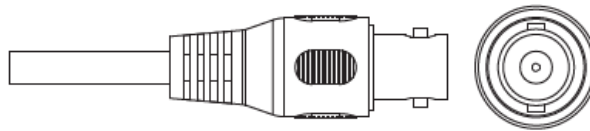

## 2.5 Audio Input Port

Connects to sound pickup devices to receive analog audio signal.

Figure 2-5 Audio input port



## 2.6 Alarm Output Port

Connects to external alarm devices such as siren to trigger alarms.

Figure 2-6 Alarm output port

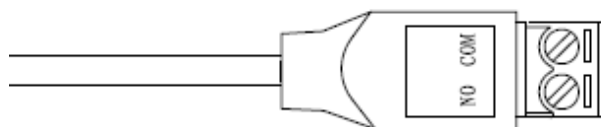

## 2.7 DIP Switch

Dial switches to change output mode. Switch up indicates **ON**, and switch down indicates **OFF**.

Figure 2-7 DIP switch

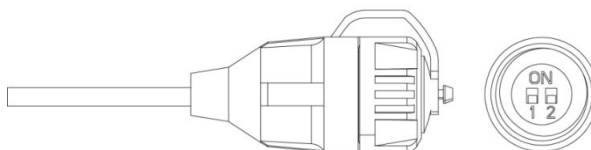

Table 2-1 Operations of DIP switch

Switch 1	Switch 2	Output Mode
OFF	OFF	CVI
ON	ON	CVBS
ON	OFF	AHD
OFF	ON	TVI

## 2.8 HD/SD Switch Control Cable

When the HD/SD switch control cable forms a short circuit, video output mode switches from HD to SD. On the contrary, it will switch back to HD video output when the cable forms an open circuit.

Figure 2-8 HD/SD switch control cable

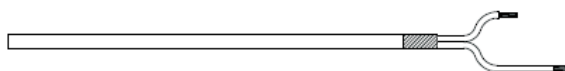

The HD/SD switch control cable is available on select models.

## 2.9 HDCVI Aviation Connector

Aviation connector could strengthen the connection of mobile devices and provide four ports for your convenience.

Figure 2-9 HDCVI aviation connector

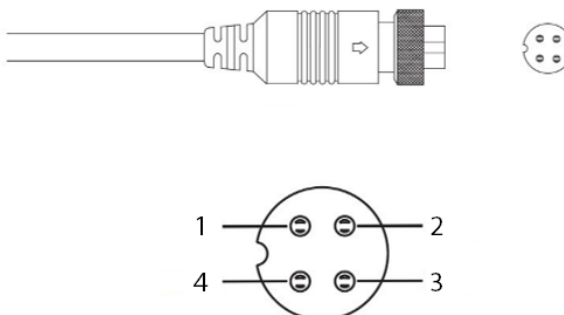

Table 2-2 HDCVI aviation connector components

No.	Name	No.	Name
1	(Yellow): Video	3	(White): Video Ground

No.	Name	No.	Name
2	(Black): Power Ground	4	(Red): Power

# 3 General Configuration and Operation

Power up the device and connect it to the XVR with coaxial cable, and then the live page is displayed. Then you can start configuring HDCVI cameras on the XVR.



- The number of the coaxial ports on XVR will display at the lower-left corner of each window to indicate the corresponding camera.
- Ports might vary depending on the XVR models. Please refer to the actual product.

## 3.1 Entering XVR Main Menu

### Procedure

- Step 1** Right-click on the live page, and the shortcut menu is displayed.
- Step 2** Click **Main Menu** and then log in to the system. The main menu of XVR is displayed.

Figure 3-1 XVR main menu

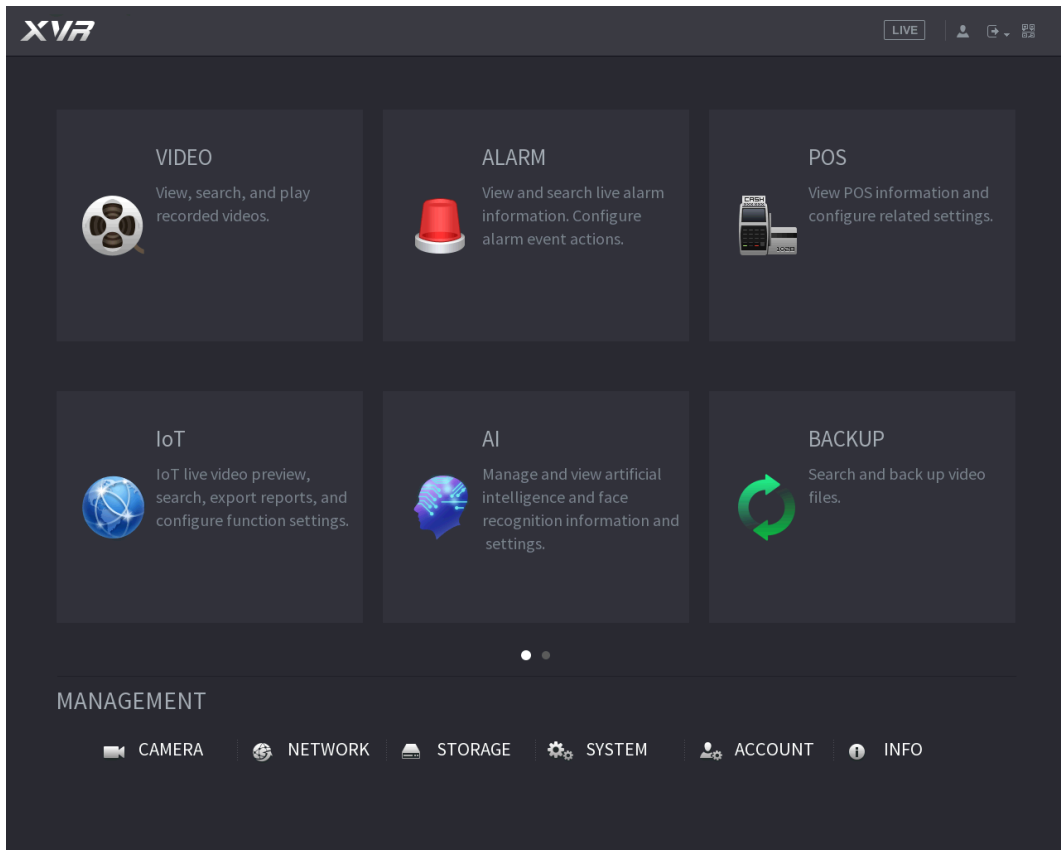

## 3.2 Setting Audio Input

### Background Information



Audio input is available on select models.

## Procedure

- Step 1 On the **Main Menu** page, select **CAMERA > ENCODE > Encode**.
- Step 2 On the **Channel** drop-down list, select the device that you want to configure according to the coaxial port No.
- Step 3 Under **Main Stream**, click **More Setting**.

Figure 3-2 Encode setting

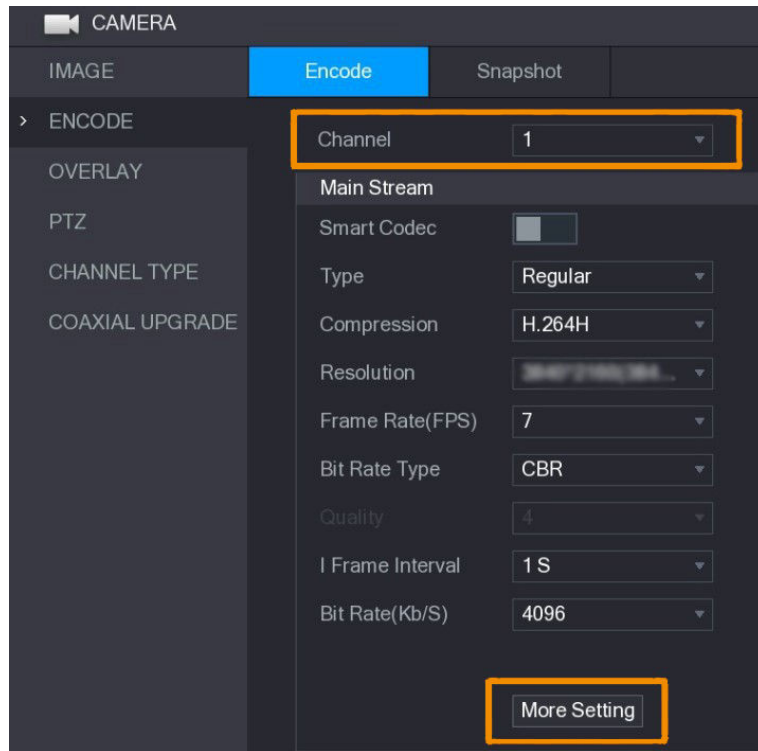

- Step 4 Enable **Audio Encode**, configure the audio settings, and then click **Save**.
- **Audio Format** : Leave it as default.
  - **Audio Source** : Select **HDCVI**.

Figure 3-3 More setting

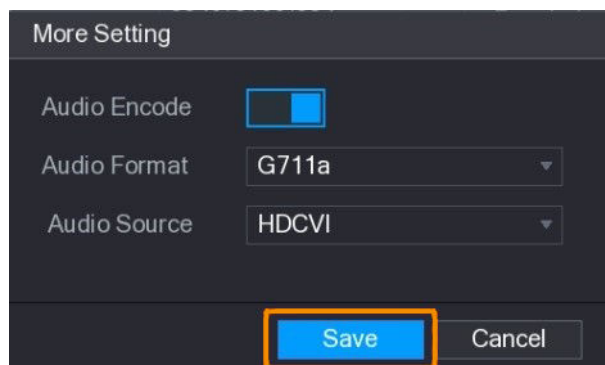

- Step 5 On the **Encode** page, click **Apply**.

## 3.3 Operating PTZ Control Panel

### 3.3.1 Operating OSD Menu

#### Background Information



- The OSD menu might vary with different cameras. Please refer to the actual product.
- When you use OSD menu to restore the device to default settings, the resolution, mode, frame rate and language of the device will not be restored.

#### Procedure

**Step 1** On the live page, right-click the device that you want to configure. The shortcut menu is displayed.

Figure 3-4 Shortcut menu

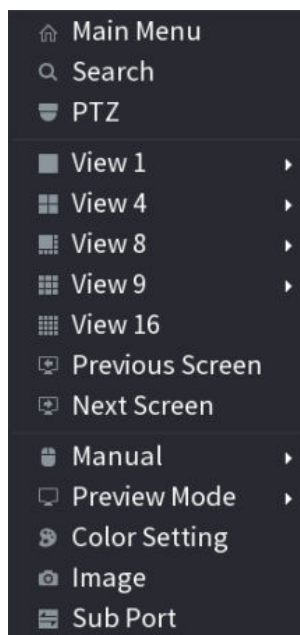

**Step 2** Click **PTZ** and click  to extend the menu.

Figure 3-5 PTZ setting options

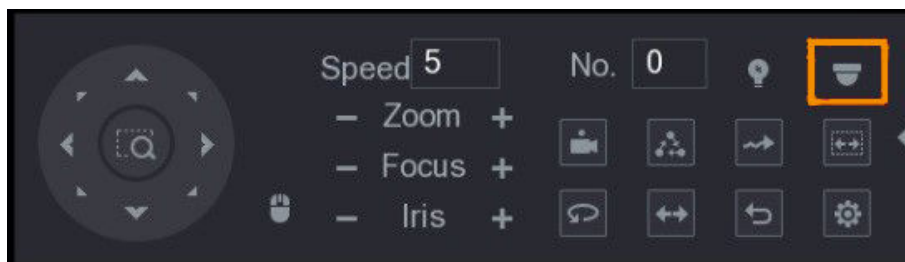

**Step 3** Click . The **MENU OPERATION** panel is displayed.



Figure 3-6 Menu operation panel

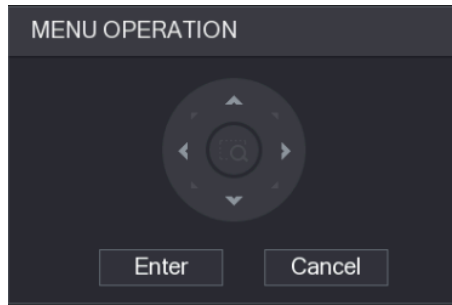
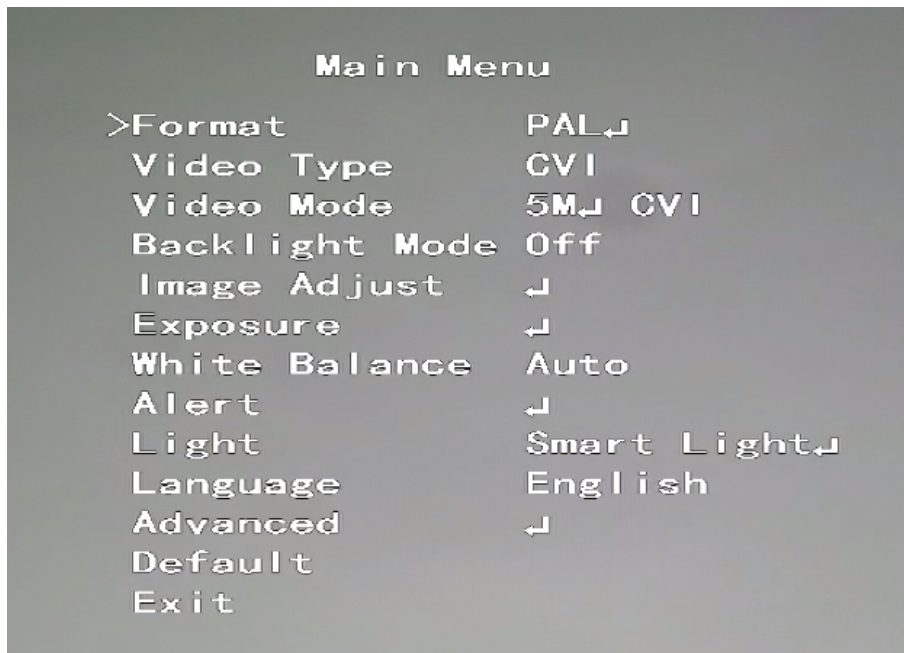

Table 3-1 Menu operation panel function

Button	Function	Button	Function
Enter	Enter or confirm an item	⬆, ⬇	Select item
Cancel	Exit OSD menu	⬅, ➡	Change item value

The OSD menu of the corresponding device is displayed on the live page. If the value of OSD item is ⬅, click **Enter** to go to the next level of this item. Click **Return** to go back to the previous level. Click **Cancel** to exit OSD menu without saving the modifications.









Figure 3-7 OSD menu



### 3.3.2 Operating Auto Focus (AF)

Table 3-2 Parameters of AF

Parameter	Description
Zoom	<ul style="list-style-type: none"> <li>• : Zoom out.</li> <li>• : Zoom in.</li> </ul>

Parameter	Description
Focus	<ul style="list-style-type: none"> <li>● : Focus far.</li> <li>● : Focus near.</li> </ul>
Iris	<ul style="list-style-type: none"> <li>● : Auto focus.</li> <li>● : Open OSD menu.</li> </ul>
PTZ movement	Supports eight directions.
	Click  , and then you can control the four directions (left, right, up, and down) of PTZ through mouse operation.
	Click  to unfold PTZ control panel.

# 4 Full-Color Camera Configuration

This chapter introduces how to configure the working modes of smart light, including auto and manual. Smart light will change the brightness of white light automatically according to the ambient lighting condition to avoid over-exposure. Smart light is only available for full-color camera.

## 4.1 Enabling/Disabling Smart Light

Smart light is enabled by default. To switch the mode of smart light, enter OSD menu (Figure 3-7) and select **Light** > **Smart Light**.

## 4.2 Configuring Smart Light Adjustment

In the smart light mode, configure the maximum brightness level of the smart light, and the device will change brightness automatically according to the ambient lighting condition. You can also configure the sensitivity of the smart light.

### Configuring Brightness Level

1. On the OSD menu, select **Light** > **Smart Light** > **Level**.
2. Select from **1** to **5** to configure the maximum brightness level.



The maximum brightness level is 5 by default.

3. Click **Return** and then **Exit** to exit the configuration.



You can also configure the brightness level manually in **Light** > **Manual** > **Level**.

### Configuring Sensitivity

1. On the OSD menu, select **Light** > **Smart Light** > **Sensitivity**.
2. Select from **1** to **5** to configure the sensitivity value of the smart light.



- The higher the value is, the easier the smart light will be woken up.
- The sensitivity value is 3 by default.

3. Click **Return** and then **Exit** to exit the configuration.

## 5 Smart Dual Illuminators Cameras Configuration

Smart dual illuminators camera supports three light modes: **Smart IR&WL** , **WL mode**, **IR mode**.

On the OSD menu, select **Illuminator**, and then view the three different modes.

- **Smart IR&WL** : Turn on the IR light in low ambient brightness. If SMD or IVS has been associated with smart dual illuminators cameras, and when the SMD detects people and vehicles on the screen, or perimeter rules are triggered by the IVS, then the camera will be controlled to turn on the warm light, and the screen automatically switch to the full-color. When SMD or IVS has detected that no rules are triggered by people and vehicles, the camera will turn off the warm light and turn on the IR light to switch to the black & white night vision.

Figure 5-1 Smart IR&WL

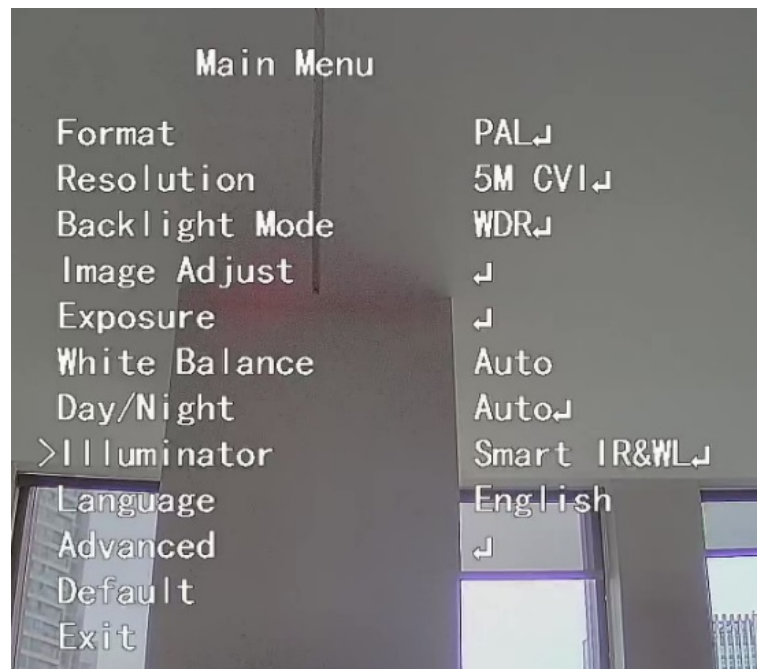

- **WL mode** : If the screen is full-color in low ambient brightness, then the camera is a full-color camera.

Figure 5-2 WL mode

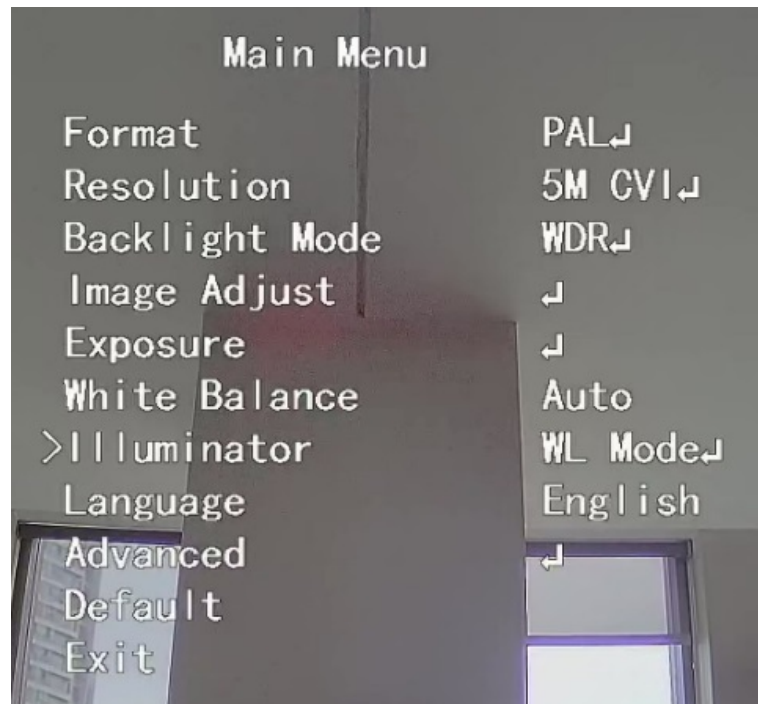

- **IR mode** : If the screen is black & white in low ambient brightness, then the camera is an IR camera.

Figure 5-3 IR mode

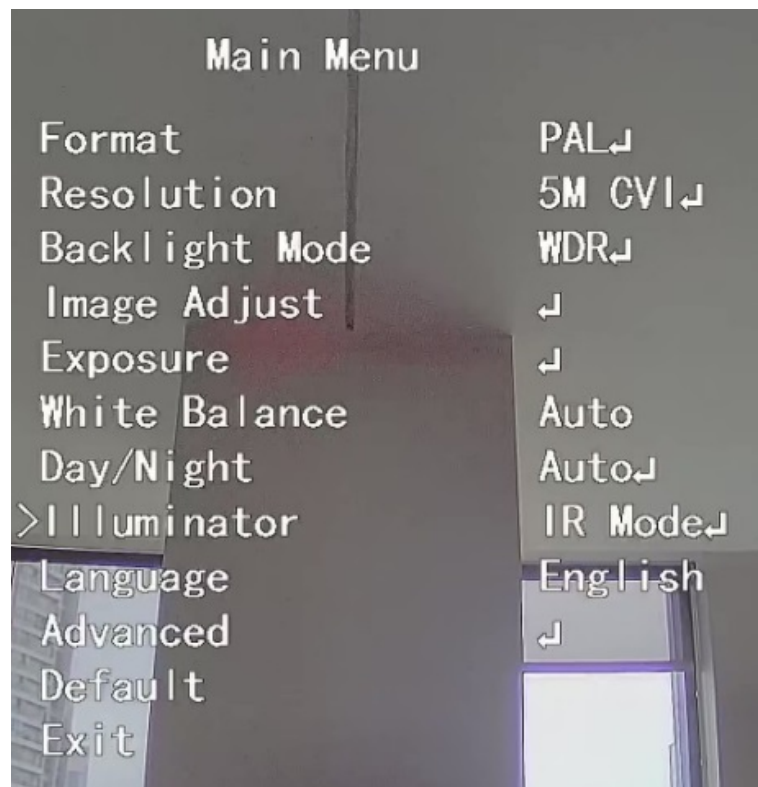

# 6 PT Camera Configuration



This function is available on select models.

## 6.1 PTZ Control

The newly-added PT rotation function based on the HDCVI camera supports rotating horizontally (0° to 355°) and vertically (0° to 90°).

You can click or click and hold up, down, left and right to control the PT rotation on the **PTZ** page, and then adjust the PT camera viewing angle.



The same operation method is applicable to XVR and DMSS.

You can click **Speed** on the **PTZ** page to control the rotating speed of the PT camera. The higher the value, the faster the camera rotates.

Figure 6-1 PTZ control

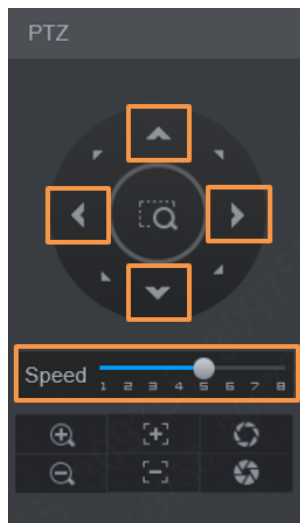

## 6.2 PT Reset

Every time the camera operates self-test once powered on, to check if it can work normally by rotating horizontally, vertically, and then rotates back to the original status. You can also select **Advanced > PT Reset** to reset the PT camera through the OSD menu, and then the camera rotates horizontally, vertically, and then rotates back to the original status.

Figure 6-2 PT reset

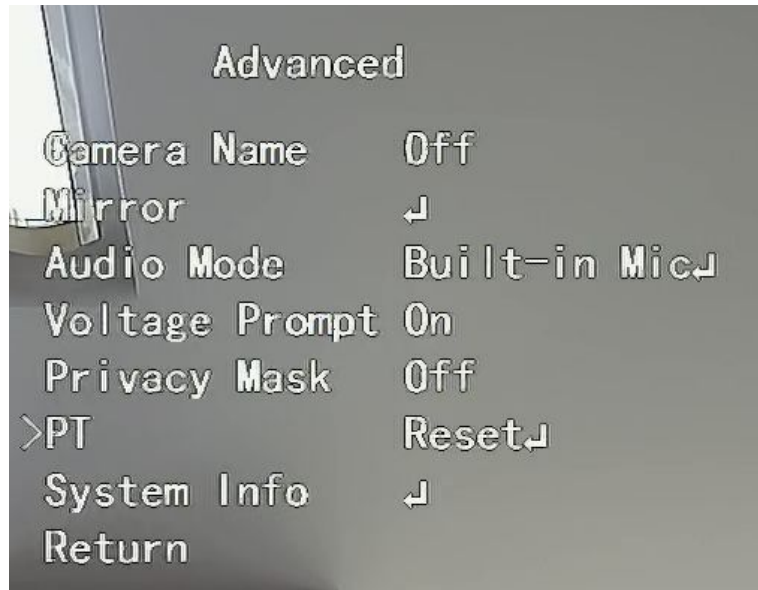

## 6.3 PT Preset

### Procedure

Step 1 On the OSD menu (Figure 3-7), select **Advanced** > **PT** > **Preset**.

Figure 6-3 PT preset (1)

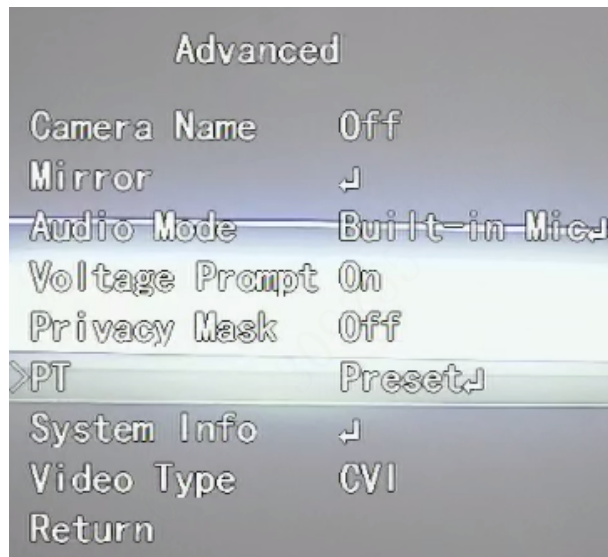

Step 2 Adjust the PT camera to the desired position, and then select the **No.** between **1** and **80**.



The number of presets is based on the actual product.

Figure 6-4 PT preset (2)

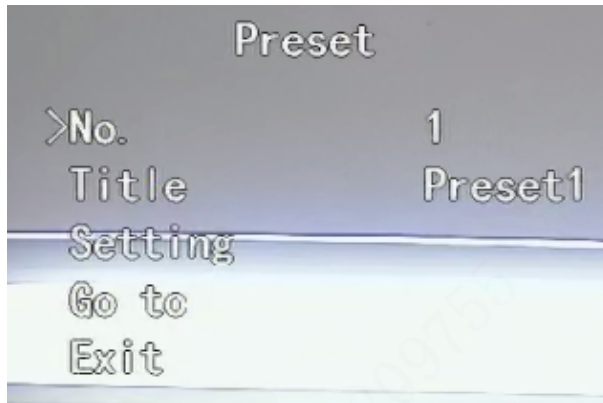

- Step 3 Select **Setting** , and then click **Enter** to save this position as a preset.  
Repeat step 2 and step 3 to set multiple presets.  
You can select a **No.** and use **go to** to call the preset.

## 6.4 Splicing Mode & Manual Linkage

### Background Information



This feature is only available for PT cameras with the manual linkage function.

### Procedure

- Step 1 On the OSD menu (Figure 3-7 ), select **Splicing Mode**, and then set the mode.
- **Vert Splice** : The device simultaneously displays the **Fixed Lens** and **PT Lens** images.

Figure 6-5 Vert splice

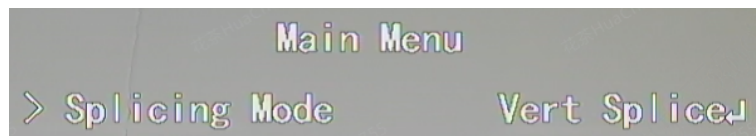

- **Panorama** : The device only displays the **Fixed Lens** image.

Figure 6-6 Panorama

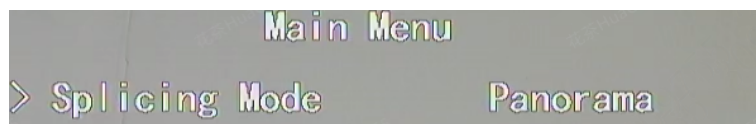

- **Details** : The device only displays the **PT Lens** image.

Figure 6-7 Details

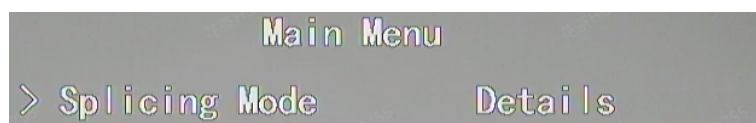

- Step 2 Select **Vert Splice** , and then click **Enter**.  
You need to calibrate the device before using the manual linkage function.





Calibrate the camera after installation. Avoid calibrating in large uniform color areas (such as white walls, grass, cement, or glass). Do not move the device during calibration, as this might impact both the success rate and accuracy.

Figure 6-8 Calibrate

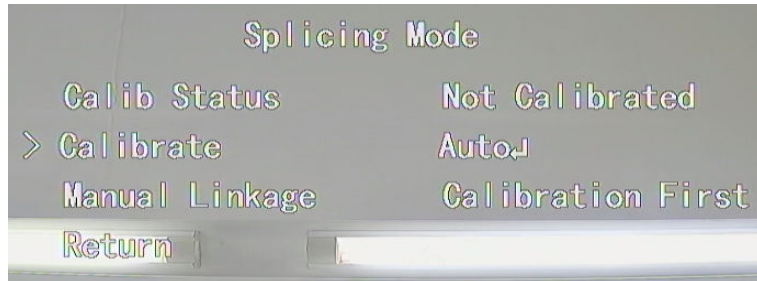

Step 3 Select **Calibrate** , and then click **Enter** to start the automatic calibration.

Figure 6-9 Calibration progress

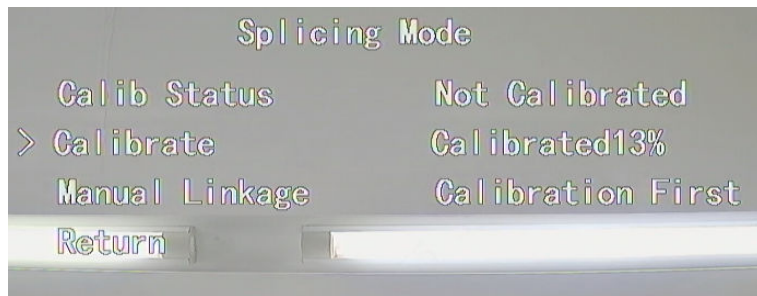

After calibration is complete, the **Calib Status** displays as **Calibrated**. If calibration fails, retry automatic calibration or use the manual calibration function of the XVR.



Calibration is only supported on select models and their specific software versions of the XVR.

Figure 6-10 Calibration failed

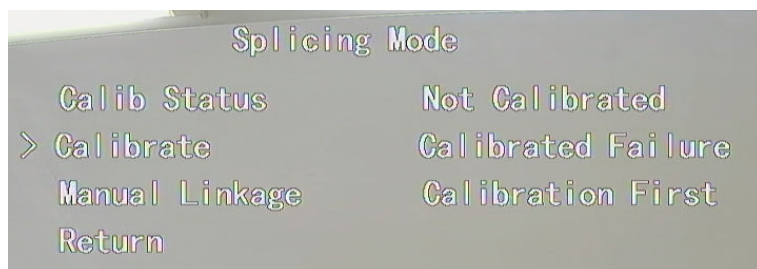

Step 4 Select **Manual Linkage** , and then click **Enter** to go to the **Area Setting** page. Move the area box in the **Fixed Lens** image, and the **PT Lens** will adjust to the corresponding position of the area box to ensure the accuracy of the calibration.

Figure 6-11 Manual linkage

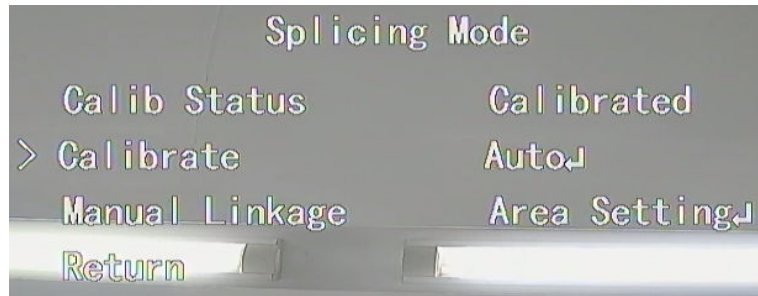

## 6.5 Linkage Tracking

### Prerequisites

You need to calibrate the device before using the linkage tracking function. For details, see [Step 3](#) in "6.4 Splicing Mode & Manual Linkage".

### Background Information



This feature is only available for PT cameras with the linkage tracking function.

### Procedure

- Step 1 On the OSD menu (Figure 3-7), select **Splicing Mode**, and then click **Enter**.  
Select **Vert Splice** from **Splicing Mode**.
- Step 2 Select **Linkage Tracking**, and then click **Enter** to go to the **Area Setting** page.

Figure 6-12 Linkage tracking

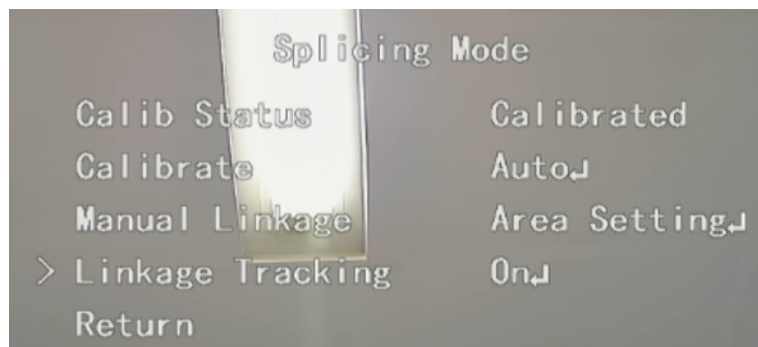

- Step 3 Enable **Area Setting**, and then click **Enter**.

Figure 6-13 Area setting

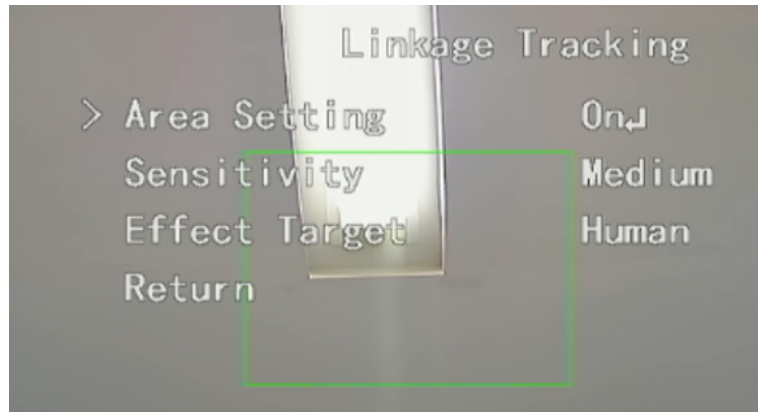

Step 4 Configure the location or size of the tracking area on the **Area Setting** page.

Figure 6-14 Location

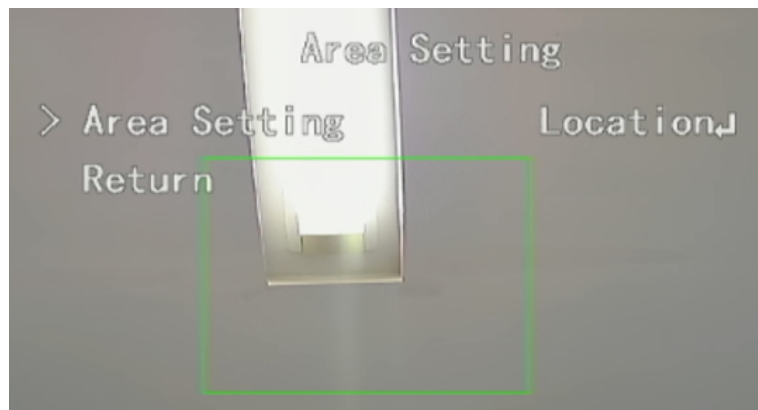
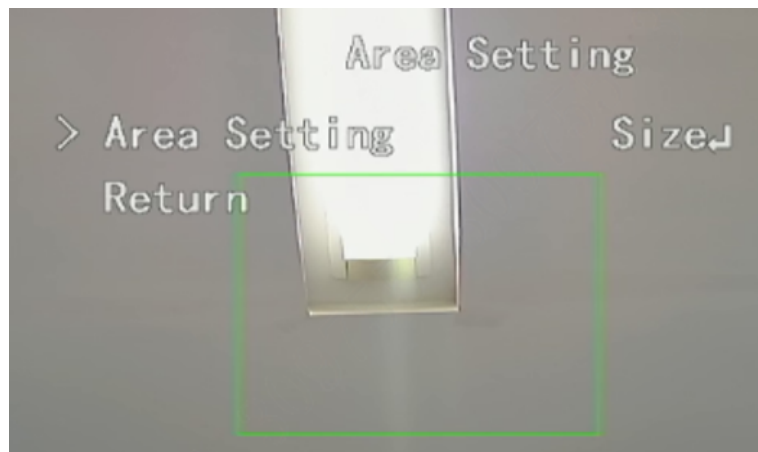

Figure 6-15 Size



# 7 Active Deterrence Camera Configuration

Active deterrence camera can warn off intruders actively with LED even before users are aware of the incident. Once an intrusion is detected, the LED will be turned on to alert the intruder.

## 7.1 Detection Range of PIR Detector

The horizontal detection range of the sensor is 100° or 110°.

Figure 7-1 Horizontal detection range

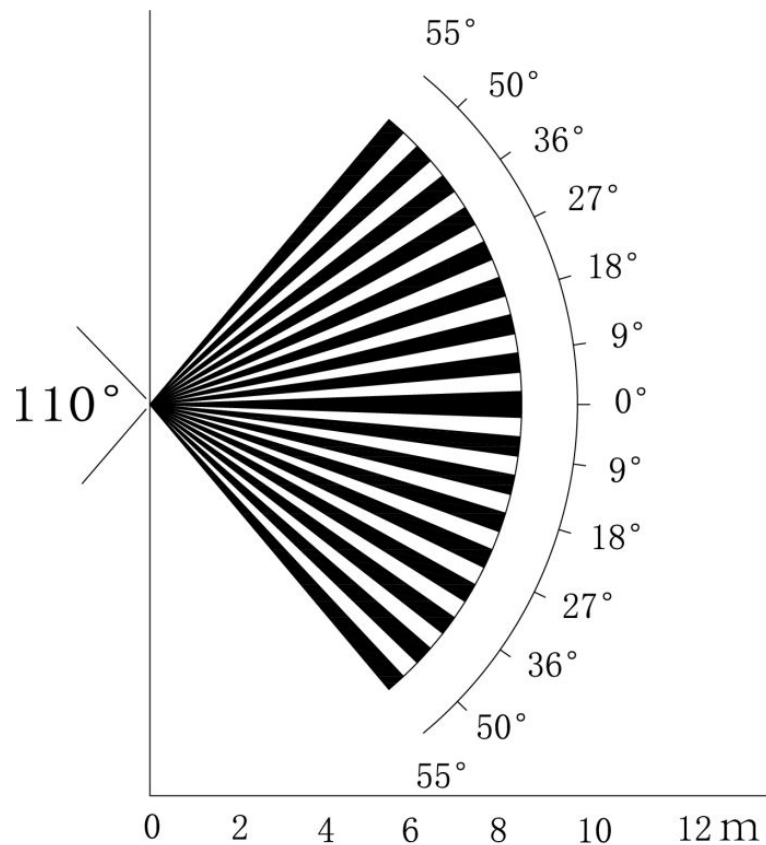

The vertical detection distance of the sensor is 2 m–10 m, 1 m–14 m or 1 m–12 m.

Figure 7-2 Vertical detection distance

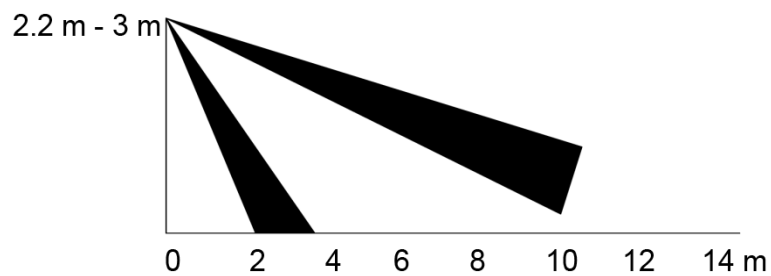

## 7.2 Configuring Trigger Mode

On the OSD menu (Figure 3-7), select **Alert > Trigger Mode**.

- If you select **Camera Set**, the sound and light alarm will be triggered in the device.
- If you select **XVR Set**, the sound and light alarm will be triggered in the XVR.



For details, see XVR user's manual.

## 7.3 Configuring Light Warning and Audio Alarm



This function is available only when the trigger mode is set to **Camera Set**.

- On the OSD menu (Figure 3-7), select **Alert**. Set **Light Warning** to **ON**, and then enter the item.
  - ◇ For **Mode**, you can select from **Lighting** to **Flash**. If you select **Flash**, you can set the **Flash Frequency** to **Low**, **Medium** or **High**.
  - ◇ For **Alert Duration**, you can adjust from **5** seconds to **60** seconds.
- On the Audio Alert item, set it to **ON**, and then enter the item.
  - ◇ In the **Audio** item, you can select from 3 audios.
  - ◇ In the **Volume** item, you can select from **Low**, **Medium** and **High**.
  - ◇ In the **Alert Duration**, you can adjust from **5** seconds to **60** seconds.

## 7.4 Configuring Smart Dual Illuminators Active Deterrence Camera

### Background Information



For details on configuring smart dual illuminators, see "5 Smart Dual Illuminators Cameras Configuration".

### Procedure

Step 1 Select **Main Menu > Alert**, and then set **Audio Alert** to **ON**.

Step 2 Set the **Volume** and **Alert Duration**.



The shortest of alert duration is 5 s, and the longest is 60 s.

Step 3 Select 5 different audio clips (including **Alarm**, **No parking here**, **Private land no entry**, **Warning zone keep off**, and **Welcome**).



You can also DIY the first clip to a .bin file and import to the back-end to use.

Figure 7-3 Main menu

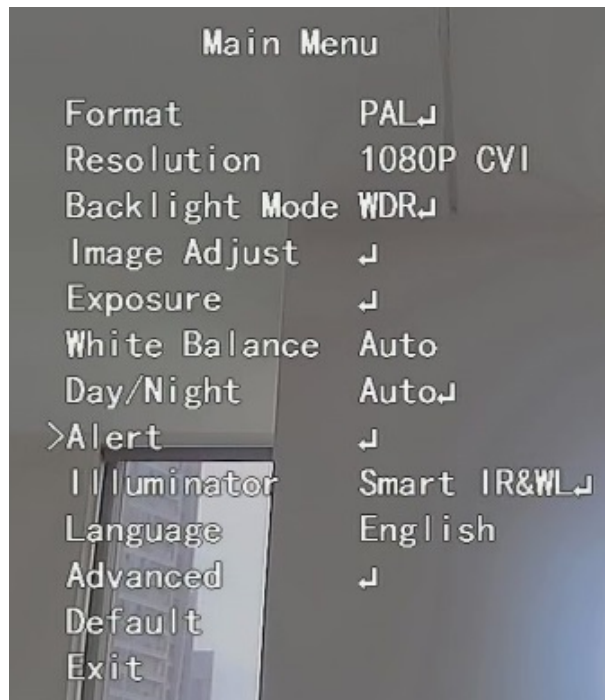

Figure 7-4 Alert

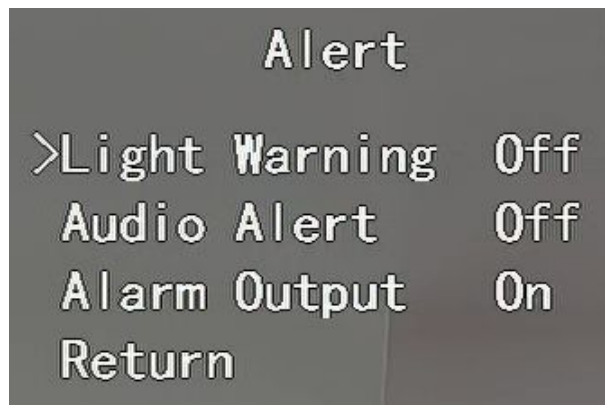
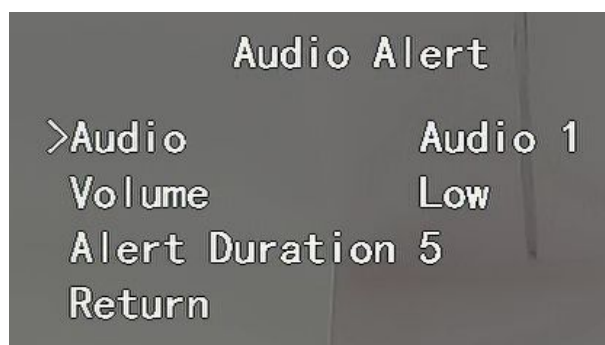

Figure 7-5 Audio alert



Step 4 Select **Main Menu** > **Alert**, and then set **Light Warning** to **ON**.

Step 5 Set the **Flash Freq** and **Alert Duration**.



The shortest of alert duration is 5 s, and the longest is 60 s.

Figure 7-6 Light warning

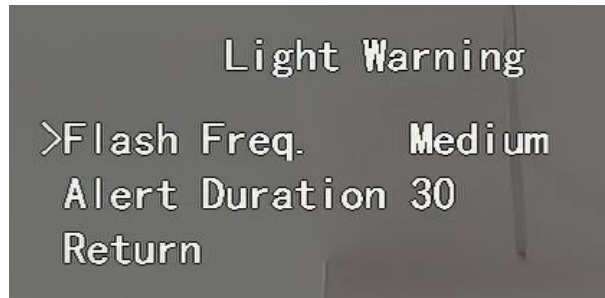

# 8 Box Camera Installation



- The device is not equipped with lens when it is delivered out of factory and you need to install lens.
- Do not remove the electrostatic adsorption film on the surface of transparent cover before installation and debugging are completed, which is to avoid damage during installation.
- Install the lens onto the device in time after unpacking, which is to avoid the device module being exposed in humid environment for a long time.
- The mounting surface shall be thick enough to sustain at least 3 times of the device weight.
- Install the C/CS adapter ring to the camera if you are using C mount lens.
- The following installation figure is for reference only.

## 8.1 Lens Installation

### 8.1.1 Installing Lens Type 1

#### Procedure

- Step 1 Remove the protection cap from the device. Align the lens to the lens position of the device (Install the C/CS adapter ring to the device if you are using C mount lens). Turn clockwise to secure the lens firmly.
- Step 2 Insert the socket of the lens cable into the auto iris lens connector on the side panel of the device. Skip this step if you are using auto iris lens.
- Step 3 Fasten the screw near the focusing ring, and then turn anti-clockwise to move the focusing ring out to focus manually until you get clear video.
- Step 4 After you completed focusing, fix the screw near the focusing ring firmly.
- Step 5 Fasten the focusing ring.

Figure 8-1 Lens installation (1)

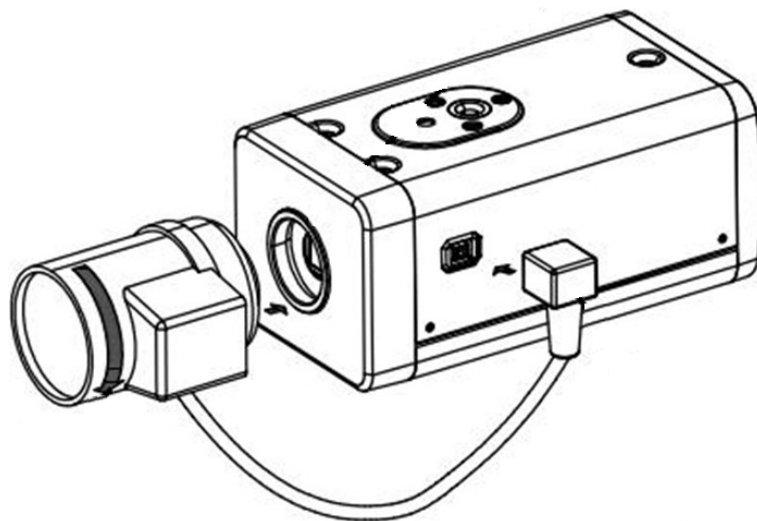



## 8.1.2 Installing Lens Type 2

### Background Information

- 1: Red sign.
- 2: Lens-dismounting button.

Figure 8-2 Front panel

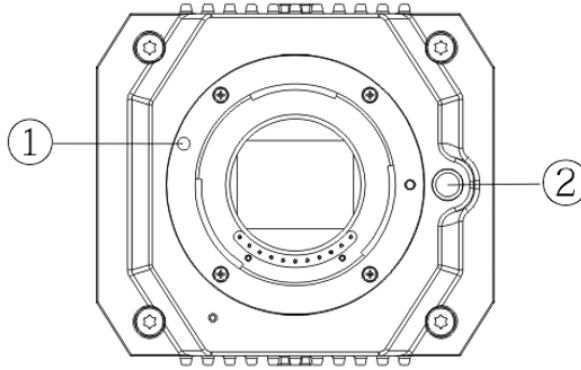

### Procedure

- Step 1 Remove the protection cover on the device lens, align the red sign of the lens with the red sign ① on the device, rotate the buckle clockwise until the lens-dismounting button ② bounces upward, and then the lens is installed.
- Step 2 Loosen the screw on the focusing ring, rotate the focusing ring outward to focus manually until you get clear video. Skip this step if you are using lens that supports auto focusing.
- 1: Screw.
  - 2: Focusing ring.

Figure 8-3 Lens installation (2)

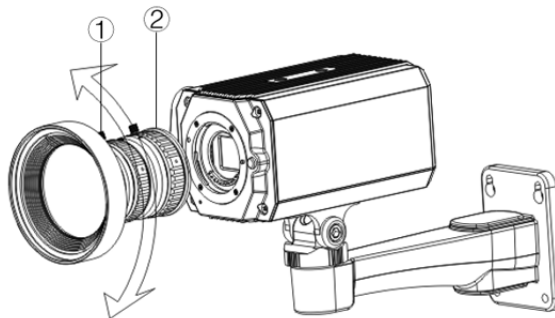

- Step 3 After focusing, tighten the screw on the focusing ring and fix the focusing ring.



To dismount the lens, press lens-dismounting button ②, rotate the lens anticlockwise, and release the buckle.

## 8.2 I/O Port Installation

## 8.2.1 Connecting Cable

### Procedure

- Step 1 Press and hold the mini screwdriver to press the button on the hole groove of the cable to be connected.
- Step 2 Insert the cable into the hole groove.
- Step 3 Release the screwdriver.

Figure 8-4 Install cable

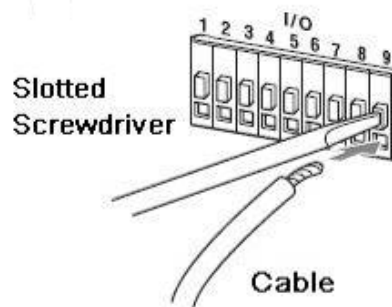

## 8.2.2 Removing Cable

### Procedure

- Step 1 Use the mini screwdriver to press the button on the hole groove of the cable to be connected.
- Step 2 Pull out the cable from the hole groove.
- Step 3 Release the screwdriver.

Figure 8-5 Remove cable

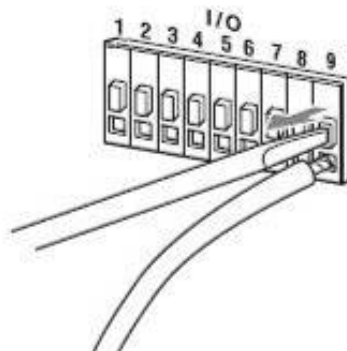

## 8.3 Device Installation

### Background Information



The device is delivered without mounting bracket and screw. You need to purchase them separately.

Figure 8-6 Device components

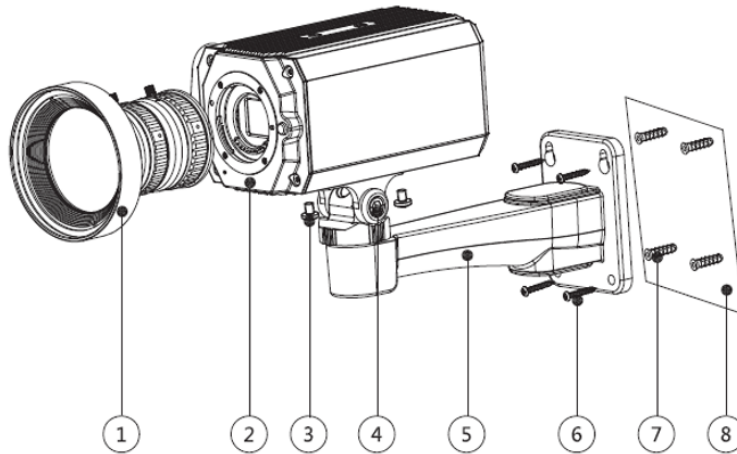

Table 8-1 Device components

No.	Name	No.	Name
1	Lens	5	Mounting bracket
2	Front panel	6	Self-tapping screw
3	Fixing screw	7	Expansion bolt
4	Bracket adjusting screw	8	Mounting surface

### Procedure

**Step 1** Fix the mounting bracket ⑤ on the mounting surface ⑧.

1. Mark the bracket mounting hole positions on the mounting surface ⑧, drill four holes on the marked positions, insert four expansion bolts ⑦ into the mounting holes and then tighten.
2. Align the four screw holes on the bottom of the mounting bracket ⑤ with the expansion bolts, insert four self-tapping screws ⑥ and then tighten.

**Step 2** Fix the device on the mounting bracket ⑤.

Align the mounting hole positions on the bottom of device casing with the mounting holes positions on the mounting bracket ⑤, and then install the device on the mounting bracket with fixing screw ③.

**Step 3** Adjust camera monitoring angle.

Use a wrench to loosen the adjusting screw ④, adjust camera to the location which needs to be monitored, and then use wrench to tighten bracket adjusting screw ④ to fix the device.

**Step 4** Connect the cable to the back panel of the device.

After device installation and cable connection, you can view monitoring image through storage device such as XVR.

# 9 Fisheye Camera Configuration

The fisheye camera (panoramic camera) has wide monitoring angle but its video is distorted. The dewarp function can provide the proper and vivid video suitable for human eyes. Fisheye function should be configured at XVR.



This function is available on select models.

## 9.1 Fisheye Dewarp on the Live Page

### Procedure

- Step 1 On the XVR shortcut menu, select **Fisheye**.
- Step 2 Set fisheye **Fit Mode** and **Show Mode**.

Figure 9-1 Fisheye menu

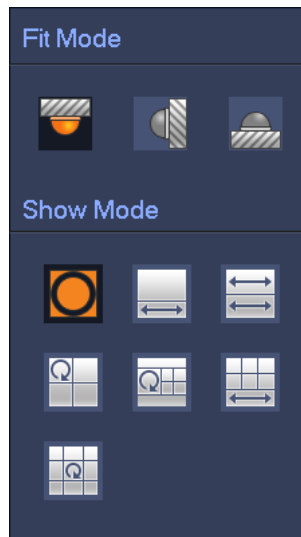

















Table 9-1 Parameters of fisheye

Fit Mode	Icon	Description
Ceiling mount  Ground mount 		360° panorama original window
		1 dewarp window and 1 panorama expanded window
		2 panorama expanded windows
		1 360° panorama window and 3 dewarp windows
		1 360° panorama window and 4 dewarp windows
		4 dewarp windows and 1 panorama expanded window
		1 360° panorama window and 8 dewarp windows
Wall mount 		360° panorama original window
		Panorama expanded window

Fit Mode	Icon	Description
		1 panorama unfolding window and 3 dewarp windows
		1 panorama unfolding window and 4 dewarp windows
		1 panorama unfolding window and 8 dewarp windows



- The dewarp modes might vary for different installation modes.
- For the non-fisheye channel, a prompt is displayed to remind you that dewarp function is not supported.
- Some series products support 180° dewarp which can only be wall mounted. The actual product shall prevail.

Figure 9-2 Fisheye show mode

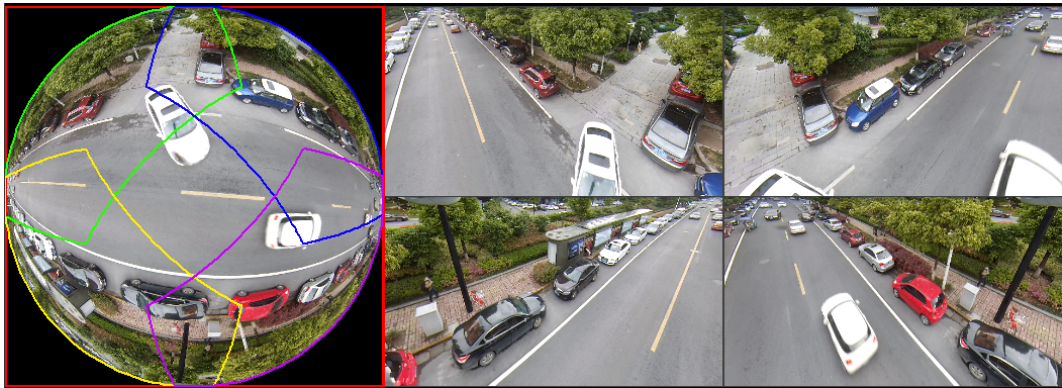



You can use the mouse to drag the color areas on the left original screen or the rectangular screens on the right to change the monitoring ranges. (Not supported for wall mount.)

## 9.2 Fisheye Dewarp During Playback

When playing back the fisheye recorded video, you can use dewarp function to adjust video.

### Procedure

- Step 1** On the XVR main menu, click **SEARCH**.
- Step 2** Select 1-window playback mode and corresponding fisheye channel, and then click  to play.
- Step 3** Right-click  to go to the dewarp playback page.

# 10 FAQ

## 10.1 Flicker

Flicker is a phenomenon where the screen flickers with stripes due to a mismatch between the device's frame rate and the frequency of light sources (such as lighting) in the environment. To resolve the flickering phenomenon, you can follow these steps:

### Procedure

- Step 1 On the OSD menu (Figure 3-7), select **Exposure** > **Anti-flicker**.
- Step 2 Switch parameter options and choose the best parameters based on the image effect.



Different devices might support different parameter options. Please refer to the actual page for the available options.

Figure 10-1 Anti-flicker (1)

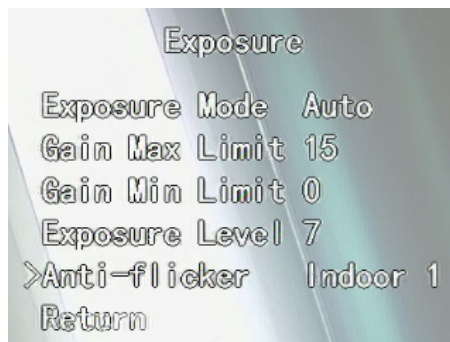
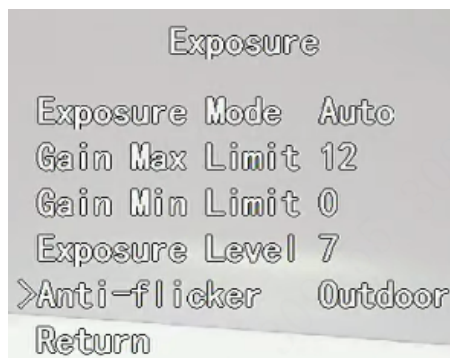

Figure 10-2 Anti-flicker (2)



## 10.2 PoC Power Supply

PoC XVR supports PoC function.



**DANGER**

- When the device is in the condition of PoC power supply, do not connect any other device between the device and PoC XVR or PoC transceiver such as UTC, Balun, optical transceiver, distributor and convertor and so on, otherwise, the device might get burned.

- PoC power supply is with high voltage. Do not dismantle the device during normal operation; otherwise it might cause danger to both device and users due to high voltage.
- Do not connect the non-PoC camera to a PoC XVR, otherwise it might damage the camera.

PoC camera can be divided into AT camera and AF camera. Power consumption of AT camera is less than 12 W, and power consumption of AF camera is less than 6 W.

You need to check the maximum power of PoC before use. Assuming that the maximum power of one XVR is 48 W, the XVR can connect AT cameras up to  $48/12=4$  and AF cameras up to  $48/6=8$ .

## 10.3 Long Distance Power Supply

In many scenarios, our clients adopt long distance power supply, transmitting 12 VDC to cameras located over 100 m. Such long distance power supply might cause problems.

### **Q1: Recurrent restart of devices or even ICR Failure.**

Possible reasons: The long power supply cable leads to a large voltage drop on the equipment power supply cable, and turning on the IR light at night leads to a further increase of the voltage drop, resulting in restart of the device. After the device is restarted, the ICR is switched to the Day mode by default. By judging the ambient light at night, the device will operate in Night mode, and then the infrared light is turned on, which causes the device to restart again because of undervoltage. Thus, ICR is switched to every 2 seconds, impacting its switching lifespan.

### **Q2: Unable to restart devices at night, and black screen or restart occurs when switching ICR.**

Possible reasons: The long power supply cable leads to a large voltage drop on the equipment power supply cable, and turning on the IR light at night leads to a further increase of the voltage drop, resulting in restart of the device and black screen.

Solution: During construction, when the camera location is far from the power supply, you need to adopt long distance separate power supply or purchase –DP dual power supply to use 24 VAC power supply.

## 10.4 Centralized Power Supply

The typical problem of centralized power supply is that there are obvious black stripes on the device screen, which interferes with the display.

The principle of centralized power supply is as follows:



Figure 10-3 Principle of centralized power supply

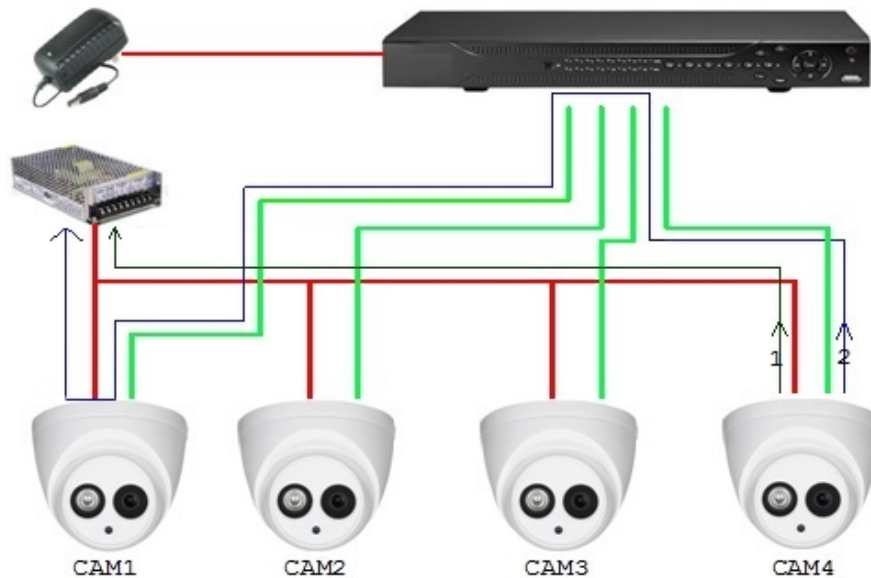

There are two paths for the power output of CAM4: Return path 1 and return path 2. Return path 1 first flows to CAM1, and then flows to the power supply ground of CAM1. In this way, the reflow of power supply ground CAM4 affects the video ground of CAM1, resulting in interference stripes on the screen. And CAM4 also interferes with CAM2 and CAM3.

In the same way, CAM1, CAM2 or CAM3 affects other cameras besides itself.

The main reason for the interference of centralized power supply is that the power supply ground of camera is not isolated. To solve this problem: Use dual-power devices with isolation of power supply ground; equip low-power devices with power isolators to block the return path 2 low-power devices can also use power isolators to block the return path 2; use isolated power supplies for each channel, or power the device separately, which are the two recommended methods.

## 10.5 Connector Waterproof Protection

HDCVI cameras need to be well waterproofed and protected. After installation, wrap the BNC connector and power connector tightly with insulated or waterproofed tape to prevent water and external electromotive forces. When metal casing device is installed on metal surfaces such as elevators and buses, the metal casing should not be in contact with the installation surface to prevent water and external electromotive forces.

Figure 10-4 Waterproof measures

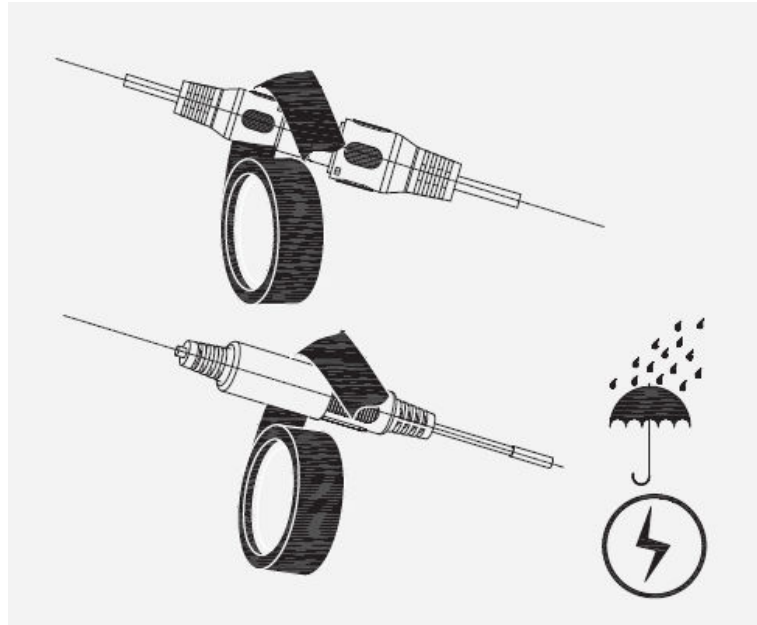

# 11 Maintenance



In order to maintain the image quality and proper functioning of the device, please read the following maintenance instructions carefully and hold rigid adherence.

## Disassembly and Desiccant Replacement

- Carefully follow the instructions in the manual when performing any disassembly operation about the device; otherwise, it might cause water leakage or poor image quality due to unprofessional disassemble.
- Please contact after-sale service for desiccant replacement if there is condensed fog found on the lens after unpacking or when the desiccant turns green. (Not all models are included with the desiccant).

## Maintaining Lens and Lens Protector

- The lens and lens protector are covered with antireflection coating, which could be contaminated or damaged and result in lens scratches or haze images when being touched with dust, grease, fingerprints and other similar substances.
- Do not touch the image sensor (CCD or CMOS) directly. Dust and dirt could be removed with air blower, or you can wipe the lens gently with soft cloth that moistened with alcohol.

## Maintaining Device Body

- Device body can be cleaned with soft dry cloth, which can also be used to remove stubborn stains when moistened with mild detergent.
- To avoid possible damage on device body coating which could cause performance decrease, do not use volatile solvent such as alcohol, benzene, diluent and so on to clean the device body, nor can strong, abrasive detergent be used.

# Appendix 1 Security Recommendation

## 1. Account Management

### a. Use Strong Passwords

- The length should not be less than 8 characters.
- Include at least two types of characters; character types include upper and lower case letters, numbers and symbols.
- Do not contain the account name or the account name in reverse order.
- Do not use continuous characters, such as 123, abc, etc.
- Do not use overlapped characters, such as 111, aaa, etc.

### b. Change Password Regularly

It is suggested to change passwords regularly to reduce the risk of being guessed or cracked.

### c. Assign Accounts and Permissions Reasonably

According to business and management needs, reasonably add new users, and reasonably allocate a minimum set of permissions for them.

### d. Enable Account Lock

The account lock feature is enabled by default, and it is recommended to keep it on to guarantee the account security. If an attacker attempts to log in with the wrong password several times, the corresponding account and the source IP address will be locked.

### e. Set and Update Passwords Reset Information Timely

The platform supports password reset function. To reduce the risk of being attacked, please set up related information for password reset in time. If the information changes, please modify it in time. When setting password protection questions, it is suggested not to use those that can be easily guessed.

### f. Enable Account Binding IP/MAC

It is recommended to enable the account binding IP/MAC mechanism to further improve access security.

## 2. Service Configuration

### a. Enable HTTPS

It is suggested to enable HTTPS, so that you visit web service through a secure communication channel.

### b. Disable Unnecessary Services and Choose Secure Modes

If not needed, it is recommended to turn off some services such as SNMP, SMTP, etc., to reduce risks.

If necessary, it is highly recommended that you use safe modes, including but not limited to the following services:

- SMTP: Choose TLS to access mailbox server.
- FTP: Choose SFTP, and set up strong passwords.

## 3. Network Configuration

### a. Enable Firewall Allowlist

It is suggested to enable allowlist function to prevent everyone, except those with specified IP addresses, from accessing the system. Therefore, please be sure to add your computer's IP address and the accompanying equipment's IP address to the allowlist.

### b. Network Isolation

The network should be isolated by partitioning the video monitoring network and the office network on the switch and router to different VLANs. This prevents attackers from using the office network to launch Pivoting attacks on the video monitoring network.

#### 4. **Security Auditing**

##### a. **Check Online Users**

It is recommended to check online users irregularly to identify whether there are illegal users logging in.

##### b. **View the Platform Log**

By viewing the log, you can get the IP information of the attempt to log in to the platform and the key operation information of the logged-in user.

#### 5. **Physical Protection**

It is suggested to perform physical protection to the device that has installed the platform. For example, place the device in a special computer room and cabinet, and implement well-done access control permission and key management to prevent unauthorized personnel from carrying out physical contacts such as damaging hardware.

#### 6. **Perimeter Security**

It is suggested to deploy perimeter security products and take necessary measures such as authorized access, access control, and intrusion prevention to protect the software platform security.